

New Parts to fit Tuttnauer Automatic Autoclaves!

Models: EZ9, EZ10, EZ10k, 1730E/EK, 2340E/EA/EK/EKA, 2540E/EA/EHS/EK/EKA & 3870EHS



**Introducing the Diagnostic Smart Kit®
For Servicing Tuttnauer® Automatic Autoclaves
RPI Part #TUK108 (OEM Part #TEST-9)**

- Calibrate/verify displayed pressure values.
- Calibrate/verify the Temperature Sensor values.
- Check and monitor all test point values from the AJUNC or ANL boards.
- Plus, Kit includes a durable plastic case and a troubleshooting information booklet.

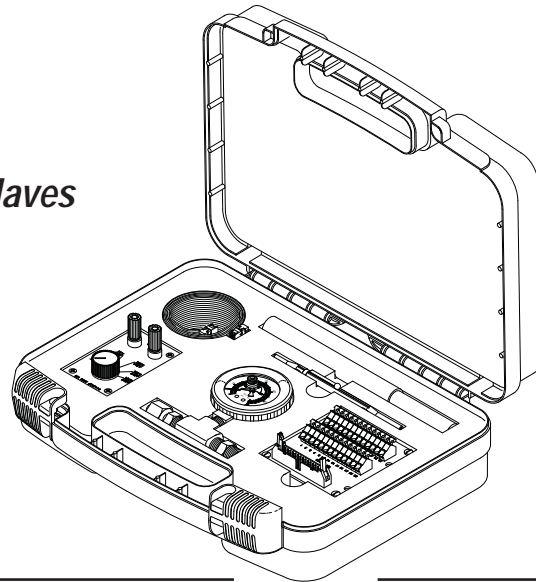

Kit includes all parts below!

RPI Part #TUT114
OEM Part #TEST-7

SIMULATOR (PT100)

- For Temperature Sensor calibration (simulates high and low temperatures)
- Use with Wire Harness No. 1, 2, or 3 (RPI Part #TUH111, TUH112, or TUH113) depending on the model number.

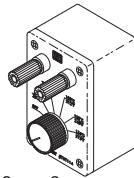

RPI Part #TUH111
OEM Part # (No OEM Part # Available)

WIRE HARNESS (No. 1)

- Small-sized 2 Pin Connector without jumper
- Use with Simulator (PT100) (RPI Part #TUT114)

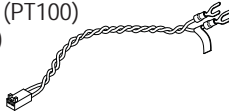

RPI Part #TUH112
OEM Part # (No OEM Part # Available)

WIRE HARNESS (No. 2)

- Medium-sized 2 Pin Connector without jumper
- Use with Simulator (PT100) (RPI Part #TUT114)

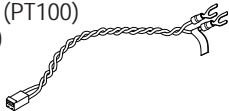

RPI Part #TUH113
OEM Part # (No OEM Part # Available)

WIRE HARNESS (No. 3)

- Large-sized 3 Pin Connector with jumper
- Use with Simulator (PT100) (RPI Part #TUT114)

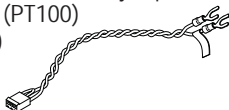

RPI Part #TUG110
OEM Part #TEST-2

PRESSURE GAUGE (TEST)

- See reverse side for more information

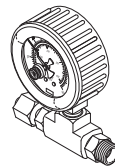

RPI Part #TUB109
OEM Part #TEST-1

TEST POINT BOARD

- Use with Ribbon Cable (RPI Part #TUC117)

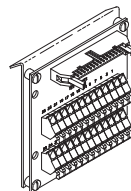

RPI Part #TUC117
OEM Part # (No OEM Part # Available)

RIBBON CABLE

- Use with Test Point Board (RPI Part #TUB109)



RPI Part #RPT460
OEM Part # (No OEM Part # Available)

TRIM POT ADJUSTMENT TOOL

- 5" Long; Plastic with stainless steel blades

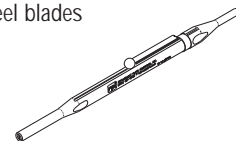

RPI Part #RPT113
OEM Part # (No OEM Part # Available)

MAX REGISTER THERMOMETER

- Use for temperature verification in sterilizers

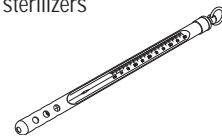

RPI Part #RPC476
OEM Part # (No OEM Part # Available)

CARRYING CASE

- Includes "Pick-n-Pluck" foam insert

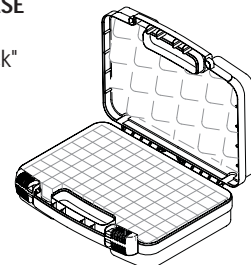
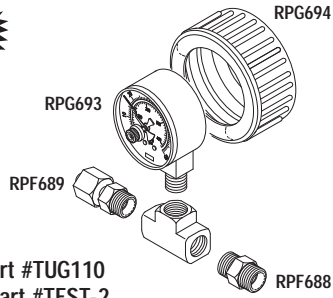

Table Top Sterilizers

Models: EZ9, EZ10, EZ10k, 1730, 2340, 2540 & 3870 Series



RPI Part #TUG110
OEM Part #TEST-2

PRESSURE GAUGE (TEST)

- Includes all parts listed below:
 - Pressure Gauge (RPI Part #RPG693)**
 - Dual scale: 0-60 PSI/0-400 kpa
 - Maximum indicating pointer for highest PSI reading
 - Gauge Guard (RPI Part #RPG694)**
 - Soft rubber; Color: Blue
 - Male Connector (RPF688)**
 - 1/4 MPT x 3/16" Brass Compression Fitting
 - Tube Adapter (RPI Part #RPF689)**
 - 1/4 MPT x 3/16" Brass Compression Tube
 - Includes (1) piece each: Compression Nut (RPI Part #RPF219) and Compression Sleeve (RPI Part #RPF215)

- All parts also sold separately
- Also included in Diagnostic Smart Kit® (RPI Part #TUK108)

Fits: Chamber manifold
Models: EZ9, EZ10, EZ10k, 1730E/EK, 2340E/EA/EK/EKA, 2540E/EA/EK/EKA & 3870EHS

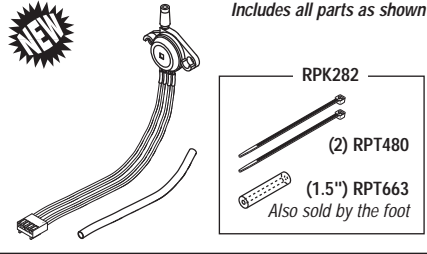

RPI Part #TUT092
OEM Part #01630101(AJUNC 2 PCB)/
01630101-1 (AJUNC 3 PCB)

PRESSURE TRANSDUCER

- Fits units with AJUNC 3 PCB; and can be easily modified to fit units with AJUNC 2 PCB
- Includes Pressure Tube Kit (RPI Part #PRK282)
- Fits:** AJUNC 2 PCB & AJUNC 3 PCB
- Models:** EZ9, EZ10, EZ10k, 1730E/EK, 2340E/EA/EK/EKA, 2540E/EA/EK/EKA & 3870E/EA

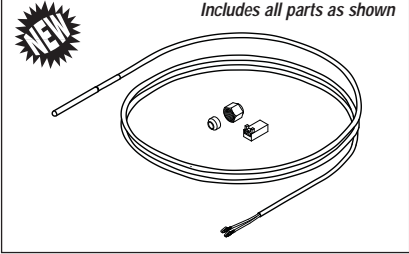

RPI Part #TUS093
OEM Part #01610501

TEMP SENSOR (PT100)

- Fits: Chamber Manifold AJUNC 3 PCB at the J11 connector
- Models:** EZ9, EZ10, EZ10k, 1730E/EK, 2340E/EA/EKA, & 2540E/EA/EKA

*Machine must be calibrated after replacing Pressure Transducer or Temp Sensor.
For Diagnostic Smart Kit® see RPI Part #TUK108 on reverse side.*



RPI Part #TUP106
OEM Part #04400299

POWER SUPPLY

- Protek brand
- Fits:** Chassis
- Models:** EZ9, EZ10, 1730E, 2340E/EA/EK/EKA, 2540E/EA/EKA & 3870E/EA



RPI Part #TUF103
OEM Part #FIL175-0006

FILTER SCREEN (New Style)

- .70" dia. x 1.26" lg.; S.S. mesh
- Fits:** Filter Cap Assembly
- Models:** 1730E/EK, 2340E/EA/EK/EKA, 2540E/EA/EK/EKA & 3870E/EA

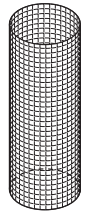

RPI PART #	DESCRIPTION
RPC476	CARRYING CASE
RPF688	MALE CONNECTOR
RPF689	TUBE ADAPTER
RPG693	PRESSURE GAUGE
RPG694	GAUGE GUARD
RPK282	PRESSURE TUBE KIT
RPT113	MAX REGISTER THERM.
RPT460	TRIM POT ADJUST. TOOL
TUB109	TEST POINT BOARD
TUC117	RIBBON CABLE

RPI PART #	DESCRIPTION
TUF103	FILTER SCREEN (NEW STYLE)
TUG110	PRESSURE GAUGE (TEST)
TUH111	WIRE HARNESS (NO. 1)
TUH112	WIRE HARNESS (NO. 2)
TUH113	WIRE HARNESS (NO. 3)
TUK108	DIAGNOSTIC SMART KIT®
TUP106	POWER SUPPLY
TUT092	PRESSURE TRANSDUCER
TUT093	TEMP SENSOR (PT100)
TUT114	SIMULATOR (PT100)

Look inside for new
Diagnostic Smart Kit®
to fit Tuttnauer
Automatic Autoclaves

ADDRESS SERVICES REQUESTED

PERMIT NO. 2399
VAN NUYS, CA
U.S. POSTAGE PAID
PRESORTED STANDARD

20338 Corisco Street • Chatsworth, California • 91311
replacement parts industries, inc.

