



# More New Parts to fit Midmark • Ritter 7 & M7 SpeedClave® Sterilizers



## INDEPENDENT BUZZER-STYLE TIMER

- Use this Kit to replace or upgrade a Timer with an independent buzzer.  
(Use *Time Switch* (RPI Part #RCT048) if you need a timer with a built-in bell.)
- Timer Knob sold separately – see RPI Part #'s RCK111 and RCK092.
- The Wire Harness in this Kit may be needed to extend the length of the original Wire Harness when upgrading to this style timer.

RPI Part #RCK116  
OEM Part #002-0373-00

**TIMER KIT (30 MIN)**  
Fits: Front Panel  
Model: M7

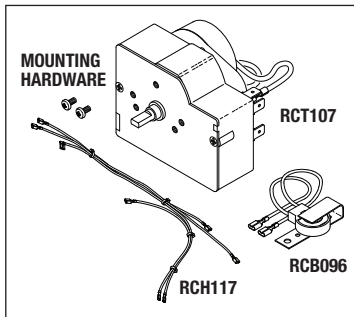

Includes all parts as shown

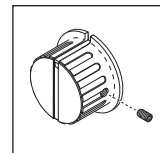

RPI Part #RCK111  
OEM Part #053-1008-01

**TIMER KNOB**  
Fits: Timer  
Model: M7

RPI Part #RCK092  
OEM Part #H98062

**TIMER KNOB**  
Fits: Timer  
Models: 7 & M7

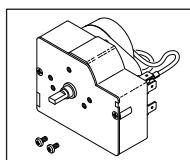
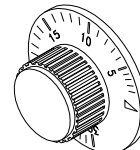

RPI Part #RCT107  
OEM Part # (No OEM Part # Available)

**TIMER (30 MIN)**  
• See "Independent Buzzer-Style" note above with Timer Kit (RPI Part #RCK116)  
Fits: Front Panel  
Model: M7

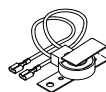

RPI Part #RCB096  
New OEM Part #015-1813-00  
Old OEM Part #015-0745-02

**BUZZER**  
Fits: Machine Base  
Model: M7

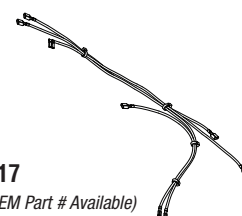

RPI Part #RCH117  
OEM Part # (No OEM Part # Available)

**WIRE HARNESS**  
• See "Independent Buzzer-Style" note above with Timer Kit (RPI Part #RCK116)  
Fits: Original Wire Harness  
Model: M7

## BUILT-IN BELL-STYLE TIMER

- Use this Timer to replace a Timer with a built-in bell. This timer will not work in conjunction with machines that utilize an independent buzzer. (Use *Timer Kit* (RPI Part #RCK116) if you need a timer with an independent buzzer.)

RPI Part #RCT048  
OEM Part #H284667-1

**TIME SWITCH**  
Fits: Front Panel  
Models: 7 & M7-without buzzer

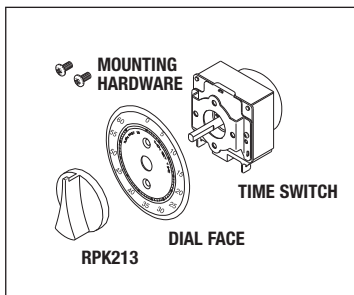

Includes all parts as shown



RPI Part #RPK213  
OEM Part # (No OEM Part # Available)

**KNOB**  
Fits: Time Switch (RPI Part #RCT048) only  
Models: 7 & M7

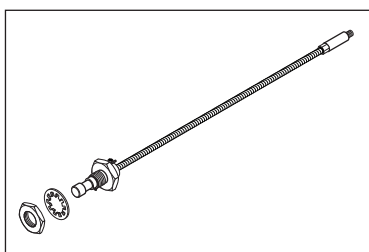

RPI Part #RCA099  
OEM Part #H98064  
**FLEX CABLE ASSEMBLY**  
Fits: Front Panel and Relay Assembly  
Models: 7 & M7

Includes all parts as shown

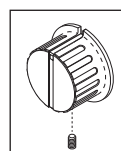

RPI Part #RCK110  
OEM Part #053-1008-00  
**TEMPERATURE KNOB**  
Fits: Flex Cable Assembly  
Model: M7

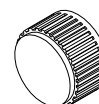

RPI Part #RCK093  
OEM Part #H98063  
**CONTROL KNOB**  
Fits: Flex Cable Assembly  
Models: 7 & M7



replacement parts industries, inc.

CALL (800) 221-9723 • FAX (818) 882-7028 • EMAIL [order@rpiparts.com](mailto:order@rpiparts.com) • WEBSITE [www.rpiparts.com](http://www.rpiparts.com)

The above parts are manufactured by Replacement Parts Industries, Inc. to fit Midmark-Ritter equipment. All product names used in this document are trademarks or registered trademarks of their respective holders. WEB flyer with newsletter 04/09



# More New Parts to fit Midmark•Ritter 7 & M7 SpeedClave® Sterilizers

**RPI Part #RCH118**  
**Old RPI Part #RCH024**  
**OEM Part #002-0839-00, H284687-1**  
**& 002-0245-00**

**HEATER ELEMENT ASSEMBLY**

- Includes all parts as shown
- See **Service Tip**
- Fits:** Chamber
- Models:** 7 & M7

**Attaching Hardware (RPI Part #RCH119)**  
 for the Heater Element Assembly (RPI Part #RCH024) is also sold separately. Includes (2) each Fiber Washer, Flat Washer, Internal Tooth Washer and Hex Nut

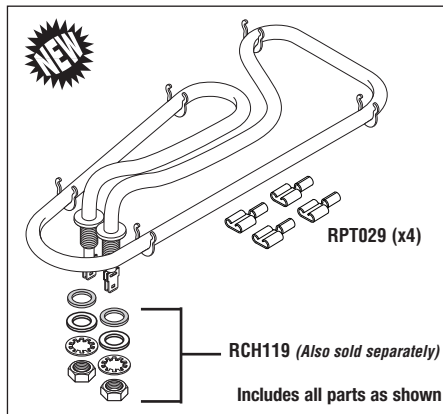

**Service Tip**

To help prevent clogging of the 7 or M7, install RPI Filter (RPI Part #MIF062) into the chamber end of the Water Fill/Exhaust line.

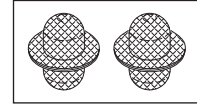

**RPI Part #MIF062**  
**New OEM Part #002-0360-00 (Mesh Style)**  
**Old OEM Part #016-0790-00**

**FILL/VENT MESH CHAMBER FILTER**

- See **Service Tip**
- Fits:** Chamber
- Models:** 7 & M7

**RPI Part #RCK106**  
**NEW OEM Part #002-0248-00**  
**OLD OEM Part #053-0513-00**

**DOOR HANDLE KIT**  
**Fits:** Door Assembly  
**Models:** 7 & M7

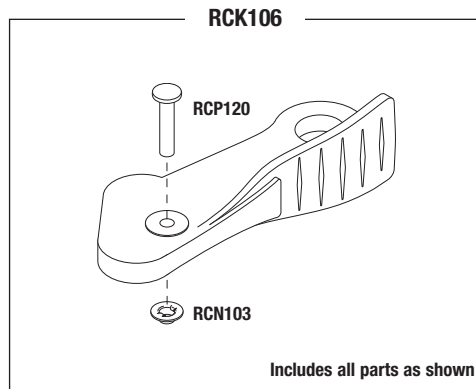

**RPI Part #RCP120**  
**OEM Part #042-0005-16**

**CAM PIN**  
**Fits:** Door Handle Assembly  
**Models:** 7 & M7



**RPI Part #RCN103**  
**OEM Part #K906034**

**PUSH CAP NUT (5/PKG)**  
**Fits:** Cam Pin (RPI Part #RCP120)  
**Models:** 7 & M7



**RPI Part #MIT047**  
**New OEM Part #002-0370-00**  
**Old OEM Part #015-0647-00**

**OVERTEMP THERMOSTAT**  
**Fits:** Bracket that mounts to under side of chamber  
**Model:** M7

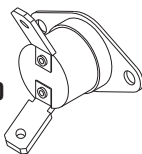

**RPI Part #RCT050**  
**OEM Part #H225639**

**MANUAL THERMOSTAT**  
**Fits:** Bracket that mounts to under side of chamber  
**Models:** 7 & M7

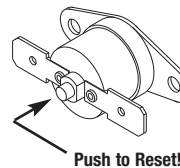

**RPI Part #RCL121**  
**OEM Part #015-1304-00**

**PILOT LIGHT (GREEN)**  
**Fits:** Front Panel  
**Model:** M7

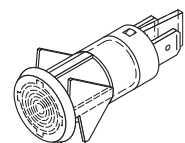

**Don't forget, RPI also carries these parts to fit Midmark•Ritter 7 & M7 sterilizers and more!**

RPI PART #	OEM PART #	DESCRIPTION	RPI PART #	OEM PART #	DESCRIPTION
PCC003	H98159	INDUSTRIAL GRADE POWER CORD (7 & M7)	RCS012	040-0010-103, H96673 & 3046	HINGE SCREW (7 & M7)
RCB002	H284709	BELLOWS ASSEMBLY (7 Only)	RCS042	002-0263-00 & 33053	RELAY SWITCH ASSEMBLY (7 & M7)
RCB089	002-0375-00	AIR VENT BELLOWS ASSEMBLY (7 & M7) (Old OEM Part #014-0193-00)	RCS086	H225730	SLEEVE (7 & M7)
RCB100	002-0375-00	AIR VENT BELLOWS ASSEMBLY (7 & M7) (Old OEM Part #014-0193-00)	RCS098	002-0247-00	VALVE STEM KIT (7 & M7)
RCC010	34646	CAM (7 Only)	RCS108	H106330	DOOR SPRING (7 & M7)
RCC095	H98009	FILL COVER (7 & M7)	RCS115	015-1791-00	FILL/VENT SWITCH (M7 Only)
RCC114	014-0236-10	COIL (FILL/VENT) (M7 Only)	RCV051	H98089 & 11683	SAFETY VALVE (31 PSI) (7 & M7)
RCF016	H98021	SUCTION CUP FOOT (7 & M7)	RCV112	014-0236-00	SOLENOID VALVE (FILL/VENT) (M7 Only)
RCG019	H98134 & 33166	DOOR GASKET (7 & M7)	RCW009	H96771 & 3059	DOOR WASHER (7 & M7)
RCG085	002-0242-00	TEMPERATURE GAUGE (DIAL THERMOMETER) (7 & M7)	RPB167	H98160	STRAIN RELIEF BUSHING (7 & M7)
RCG087	H98135	RESERVOIR GASKET (7 & M7)	RPF426	053-0990-00	FEMALE QUICK CONNECT FITTING (GREY) (M7 Only)
RCG104	053-1579-00	FIBER GASKET (7 & M7)	RPF427	053-0990-01	MALE QUICK CONNECT FITTING (GREY) (M7 Only)
RCK113	014-0236-11	REPAIR KIT (FILL/VENT) (M7 Only)	RPF679	015-0346-35	FUSE (12A, 250VAC) - FAST ACTING (M7)
RCL090	H98036	PILOT LIGHT (RED) (7 & M7)	RPH674	015-1259-04	FUSE HOLDER (M7 Only)
RCN013	041-0010-08 & 3047	HINGE SCREW NUT (7 & M7)	RPK431	002-0653-00	DRAIN TUBE ASSEMBLY KIT (M7)
RCP011	042-0007-07 & H97989	CAM PIN (7 & M7)	RPO306	H98136 & 36906	O-RING (7 & M7)

See the RPI Catalog or website for more parts to fit the 7 & M7 sterilizers!

Note: Parts fit model(s) noted to the right of the descriptions above.