



**New Parts & Recap of Existing Parts to fit Stryker®**

**900 SERIES CAST CUTTERS**



**Did You Know ...**

To access the housing for the Stryker 900 series cast cutters, simply remove the screws located under the Power Switch Label and cap.

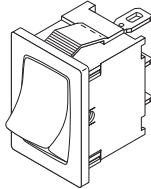
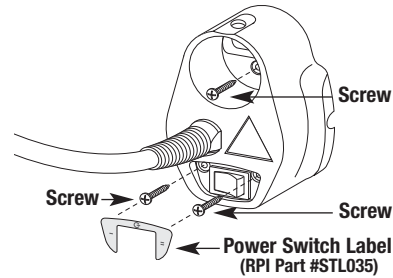

**RPI Part #STS034**  
**OEM Part #** (No OEM Part # Available)  
**POWER SWITCH**  
**Models:** Cast Cutter: 940 & 941

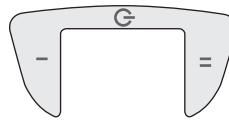

**RPI Part #STL035**  
**OEM Part #** (No OEM Part # Available)  
**POWER SWITCH LABEL** (3/pkg)  
**Models:** Cast Cutter: 940 & 941

*Perfect for sealing  
 Power Switch  
 connections!*

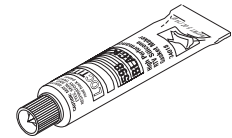

**RPI Part #RPS639**  
**OEM Part #** (No OEM Part # Available)  
**SILICONE GASKET MAKER 598**  
**Models:** Cast Cutter: 940 & 941



**RPI Part #STB031**  
**OEM Part #** (No OEM Part # Available)  
**FRONT BEARING**  
**Models:** Cast Cutter: 940 & 941

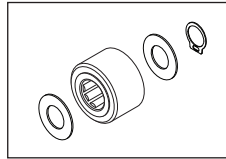

**RPI Part #STK030**  
**OEM Part #28-111 (Retaining Ring only), 11-275 (Washers only), 81-118 (Needle Bearing only)**  
**ROLLER BEARING KIT**  
**Models:** Cast Cutter: 940 & 941



**RPI Part #STB032**  
**OEM Part #** (No OEM Part # Available)  
**REAR BEARING**  
**Models:** Cast Cutter: 940 & 941



**RPI Part #STA028**  
**OEM Part #** (No OEM Part # Available)  
**ARMATURE ASSEMBLY (115VAC)**  
**Models:** Cast Cutter: 940

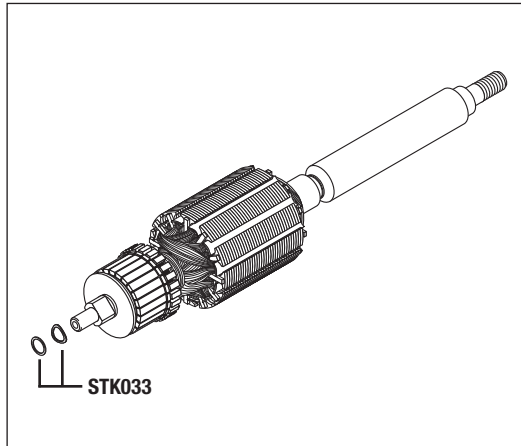

**RPI Part #STK033**  
**OEM Part #** (No OEM Part # Available)  
**ARMATURE WASHER KIT**  
**Models:** Cast Cutter: 940 & 941

*Also fits 800 Series!*

**RPI Part #STB002**  
**OEM Part #870-1-13, 940-1-113 (Brush only), 38-49 (Spring only)**  
**BRUSH** (2/pkg)  
**Models:** Cast Cutter: 940 & 941

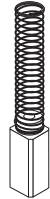

**RPI Part #RPC667**  
**OEM Part #58-18**  
**BRUSH CAP** (6/pkg)  
**Models:** Cast Cutter: 940 & 941

**Look inside for more parts to fit Stryker 800 & 900 Series Autopsy Saws and Cast Cutters!**



**replacement parts industries, inc.**

CALL (800) 221-9723 • FAX (818) 882-7028 • EMAIL [order@rpiparts.com](mailto:order@rpiparts.com) • WEBSITE [www.rpiparts.com](http://www.rpiparts.com)

The above parts are manufactured by Replacement Parts Industries, Inc. to fit Stryker equipment. All product names used in this document are trademarks or registered trademarks of their respective holders. Website 06/08

# 900 SERIES CAST CUTTERS (Continued)



Now can be used with  
800 & 900 Series!

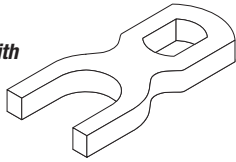

**RPI Part #STL016**  
**OEM Part #** (No OEM Part # Available)  
**SHAFT LINK**  
Models: Cast Cutter: 940 & 941



Now can be used with  
800 & 900 Series!

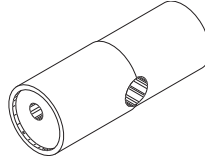

**RPI Part #STT010**  
**OEM Part #** (No OEM Part # Available)  
**CAM TOOL**  
• Used to install and remove Cam  
(RPI Part #STC029 & STC009)  
Models: Cast Cutter: 940 & 941

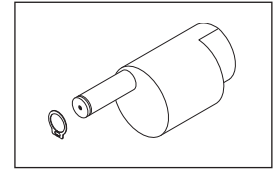

**RPI Part #STC029**  
**OEM Part #** (No OEM Part # Available)  
**CAM**  
Models: Cast Cutter: 940 & 941



**RPI Part #STK037**  
**OEM Part #** (No OEM Part # Available)  
**POWER CABLE KIT**  
• Includes all parts as shown  
Models: Cast Cutter: 940 & 941

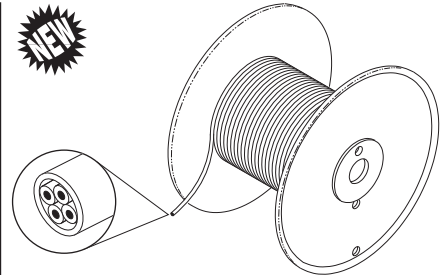
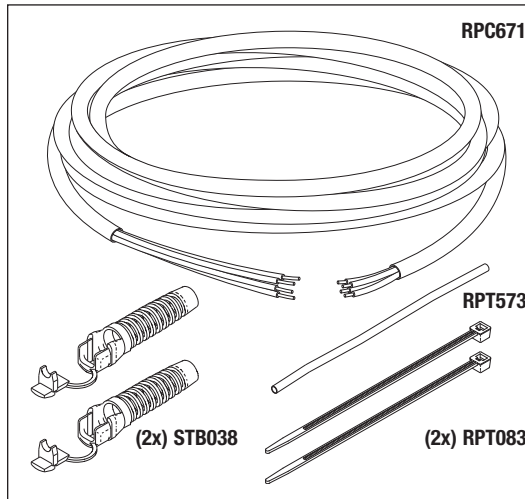

• White PVC Jacket  
• Colors: black, red,  
green, and yellow

**RPI Part #RPC671**  
**OEM Part #** (No OEM Part # Available)  
**CABLE (4 CONDUCTOR)**  
• Sold by the foot (reel not included)  
Models: Cast Cutter: 940 & 941

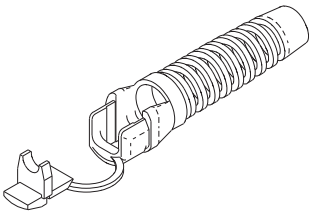

**RPI Part #STB038**  
**OEM Part #** (No OEM Part # Available)  
**STRAIN RELIEF BUSHING (5/pkg)**  
Models: Cast Cutter: 940 & 941

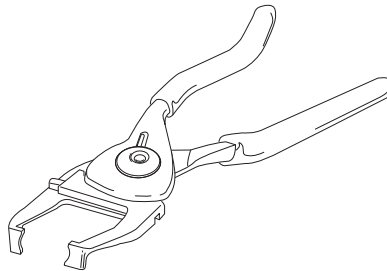

**RPI Part #RPT172**  
**OEM Part #** (No OEM Part # Available)  
**STRAIN RELIEF BUSHING PLIERS**  
Models: Cast Cutter: 940 & 941

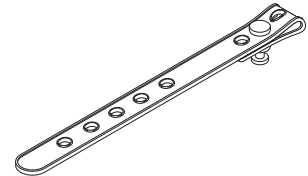

**Service Tip**  
Perfect for strapping the Power Cord  
to the Vacuum Hose!

**RPI Part #RPS672**  
**OEM Part #** (No OEM Part # Available)  
**CORD STRAP (WHITE 6") (3/pkg)**  
Models: Cast Cutter: 940 & 941

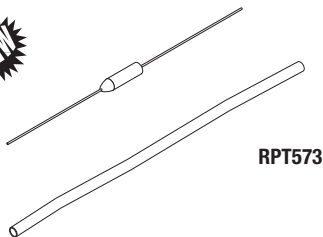

**RPI Part #STF036**  
**OEM Part #** (No OEM Part # Available)  
**THERMAL FUSE (104°C)**  
Models: Cast Cutter: 940 & 941

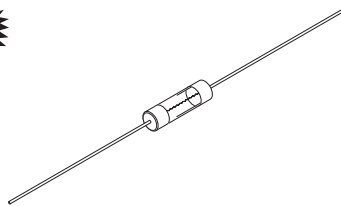

**RPI Part #RPF665**  
**OEM Part #** (No OEM Part # Available)  
**AXIAL LEAD FUSE (2-1/2A) (5/pkg)**  
Models: Cast Cutter: 940

**O-Ring shapes  
to fit Housing**

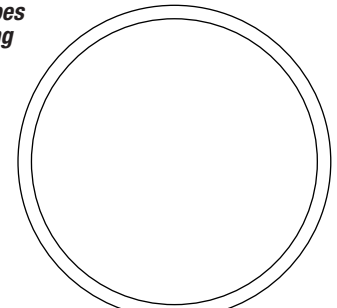

**RPI Part #RPO335**  
**OEM Part #45-29**  
**O-RING (12/pkg)**  
Models: Cast Cutter: 940 & 941

ACTUAL SIZE  
1.489" ID x 1.629" OD x .070" C/S

# 800 SERIES AUTOPSY SAWS AND CAST CUTTERS



Now can be used with  
800 & 900 Series!

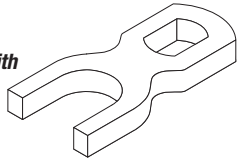

**RPI Part #STL016**  
**OEM Part #840-1-5 (800 Series only)**

**SHAFT LINK**

**Models:** Autopsy Saw: 810 & 811;  
Cast Cutter: 840, 841, 848 & 851



Now can be used with  
800 & 900 Series!

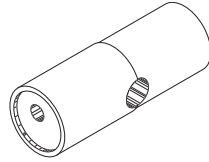

**RPI Part #STT010**  
**OEM Part # (No OEM Part # Available)**

**CAM TOOL**

• Used to install and remove Cam  
(RPI Part #STC009 & STC029)

**Models:** Autopsy Saw: 810 & 811;  
Cast Cutter: 840, 841, 848 & 851

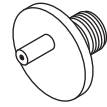

**RPI Part #STC009**  
**OEM Part #840-2-7**

**CAM**

**Models:** Autopsy Saw: 810 & 811;  
Cast Cutter: 840, 841, 848 & 851

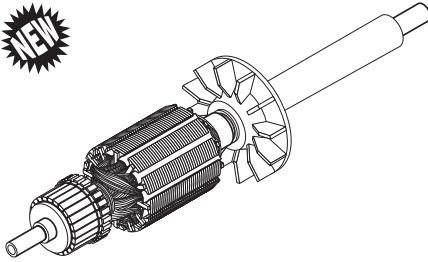

**RPI Part #STA026**  
**OEM Part #870-1-8**

**ARMATURE ASSEMBLY (115VAC)**

**Models:** Autopsy Saw: 810;  
Cast Cutter: 840 & 848

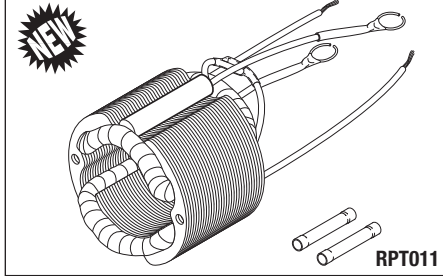

**RPI Part #STF027**  
**OEM Part #840-3-32**

**FIELD ASSEMBLY (115VAC)**

**Models:** Autopsy Saw: 810;  
Cast Cutter: 840 & 848

Also fits 900 Series!

**RPI Part #STB002**  
**OEM Part #870-1-13, 940-1-113**  
**(Brush only), 38-49 (Spring only)**

**BRUSH (2/pkg)**

**Models:** Autopsy Saw: 810 & 811;  
Cast Cutter: 840, 841, 848 & 851

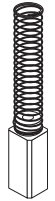

**RPI Part #RPC039**  
**OEM Part # (No OEM Part # Available)**

**BRUSH CAP (6/pkg)**

**Models:** Autopsy Saw: 810 & 811;  
Cast Cutter: 840, 841, 848 & 851

**RPI Part #STS023**  
**OEM Part #870-1-3**

**SHAFT**

**Models:** Cast Cutter: 840, 841, 848  
& 851

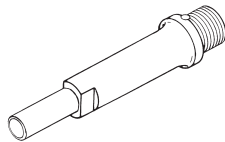

**RPI Part #STS018**  
**OEM Part #840-3-21**

**SWITCH ASSEMBLY**

**Models:** Autopsy Saw: 810 & 811;  
Cast Cutter: 840, 841, 848 & 851

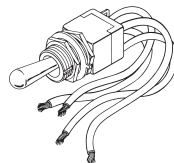

**RPI Part #STB015**  
**OEM Part #840-25-11**

**CAST CUTTER BLADE (2-1/2")**

**Models:** Cast Cutter: 840, 841,  
848 & 851

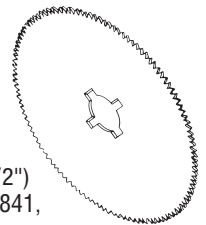

**RPI Part #STW025**  
**OEM Part #13-4**

**INTERNAL TOOTH WASHER**

**Models:** Autopsy Saw: 810 & 811;  
Cast Cutter: 840, 841, 848 & 851

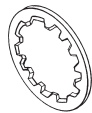

**RPI Part #STB003**  
**OEM Part #81-117**

**FRONT BEARING**

**Models:** Autopsy Saw: 810 & 811;  
Cast Cutter: 840, 841, 848 & 851

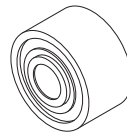

**RPI Part #STG013**  
**OEM Part #840-1-10**

**GASKET**

**Models:** Autopsy Saw: 810 & 811;  
Cast Cutter: 840, 841, 848 & 851

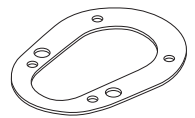

**RPI Part #STN017**  
**OEM Part #840-1-14**

**SHAFT NUT**

**Models:** Autopsy Saw: 810 & 811;  
Cast Cutter: 840, 841, 848 & 851

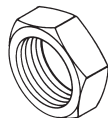

**RPI Part #STB004**  
**OEM Part #81-147**

**NEEDLE BEARING**

**Models:** Autopsy Saw: 810 & 811;  
Cast Cutter: 840, 841, 848 & 851

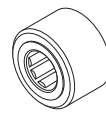

**RPI Part #STC011**  
**OEM Part #840-1-13**

**COLLAR**

**Models:** Autopsy Saw: 810 & 811;  
Cast Cutter: 840, 841, 848 & 851



**RPI Part #STS021**  
**OEM Part #47-5**

**OIL SEAL**

**Models:** Autopsy Saw: 810 & 811;  
Cast Cutter: 840, 841, 848 & 851



**RPI Part #STB005**  
**OEM Part #81-138**

**REAR BEARING**

**Models:** Autopsy Saw: 810 & 811;  
Cast Cutter: 840, 841, 848 & 851



**RPI Part #STD012**  
**OEM Part #840-2-4**

**FELT OIL DISTRIBUTOR**

**Models:** Autopsy Saw: 810 & 811;  
Cast Cutter: 840, 841, 848 & 851

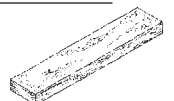



# replacement parts industries, inc.

CALL (800) 221-9723 • FAX (818) 882-7028 • EMAIL [order@riparts.com](mailto:order@riparts.com) • WEBSITE [www.riparts.com](http://www.riparts.com)

LIST OF RPI PARTS TO FIT STRYKER  
AUTOPSY SAWS AND CAST CUTTERS  
AS OF DECEMBER, 2008.

RPI PART #	OEM PART #	DESCRIPTION	AUTOPSY SAWS & CAST CUTTERS 800 & 900 SERIES								NOTES
			810	811	840	841	848	851	940	941	
RPC039	(No OEM Part # Available)	BRUSH CAP WITH - 6/PKG	810	811	840	841	848	851			
RPC667	58-18	BRUSH CAP - 6/PKG							940	941	
RPC671	(No OEM Part # Available)	CABLE (4 CONDUCTOR)							940	941	
RPF665	(No OEM Part # Available)	AXIAL LEAD FUSE (2-1/2A) - 5/PKG							940	941	
RPO335	45-29	O-RING - 12/PKG							940	941	
RPS639	(No OEM Part # Available)	SILICONE GASKET MAKER 598							940	941	
RPS672	(No OEM Part # Available)	CORD STRAP (WHITE-6") - 3/PKG							940	941	
RPT172	(No OEM Part # Available)	STRAIN RELIEF BUSHING PLIERS							940	941	
STA026	870-1-8	ARMATURE ASSEMBLY (115VAC)	810		840		848				
STA028	(No OEM Part # Available)	ARMATURE ASSEMBLY (115VAC)							940		
STB002	870-1-13/940-1-113 (Brush Only) 38-49 (Spring Only)	BRUSH - 2/PKG	810	811	840	841	848	851	940	941	
STB003	81-117	FRONT BEARING	810	811	840	841	848	851			
STB004	81-147	NEEDLE BEARING	810	811	840	841	848	851			
STB005	81-138	REAR BEARING	810	811	840	841	848	851			
STB015	840-25-11	CAST CUTTER BLADE (2-1/2")			840	841	848	851			
STB031	(No OEM Part # Available)	FRONT BEARING							940	941	
STB032	(No OEM Part # Available)	REAR BEARING							940	941	
STB038	(No OEM Part # Available)	STRAIN RELIEF BUSHING - 5/PKG							940	941	
STC009	840-2-7	CAM	810	811	840	841	848	851			
STC011	840-1-13	COLLAR	810	811	840	841	848	851			
STC029	(No OEM Part # Available)	CAM							940	941	
STD012	840-2-4	FELT OIL DISTRIBUTOR	810	811	840	841	848	851			
STF027	840-3-32	FIELD ASSEMBLY (115VAC)	810		840		848				
STF036	(No OEM Part # Available)	THERMAL FUSE (104°C)							940	941	
STG013	840-1-10	GASKET	810	811	840	841	848	851			
STK030	28-11 (Retaining Ring only)/ 11-275 (Washers only)/ 81-118 (Needle Bearing only)	ROLLER BEARING KIT							940	941	
STK033	(No OEM Part # Available)	ARMATURE WASHER KIT							940	941	
STK037	(No OEM Part # Available)	POWER CABLE KIT							940	941	
STL016	840-1-5 (810, 811, 840, 851 & 848)/ (No OEM Part # Available for 940 & 941)	SHAFT LINK	810	811	840	841	848	851	940	941	
STL035	(No OEM Part # Available)	POWER SWITCH LABEL - 3/PKG							940	941	
STN017	840-1-14	SHAFT NUT	810	811	840	841	848	851			
STS018	840-3-21	SWITCH ASSEMBLY	810	811	840	841	848	851			
STS021	47-5	OIL SEAL	810	811	840	841	848	851			
STS023	870-1-3	SHAFT			840	841	848	851			
STS034	(No OEM Part # Available)	POWER SWITCH							940	941	
STT010	(No OEM Part # Available)	CAM TOOL	810	811	840	841	848	851	940	941	
STW025	13-4	INTERNAL TOOTH WASHER	810	811	840	841	848	851			



# replacement parts industries, inc.

20338 Corisco Street • Chatsworth, California • 91311

PRESORTED STANDARD  
U.S. POSTAGE PAID  
VAN NUYS, CA  
PERMIT NO. 2399

ADDRESS SERVICES REQUESTED

**LOOK INSIDE!  
NEW PARTS & UPDATE ON EXISTING PARTS  
TO FIT STRYKER AUTOPSY SAWS & CAST CUTTERS  
800 & 900 SERIES.**