

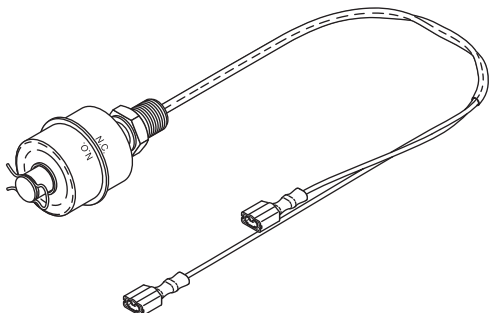

New Parts to fit Getinge/Castle Bulk Sterilizers!



RPI Part #CSS105
OEM Part #61301601173

LIQUID LEVEL SENSOR

- Material: 316 Stainless steel float and brass stem
- 1/8" MPT
- Wire leads 9-1/2" and 11"
- 3/16" insulated QC terminals
- SPST; 120-240 VAC

Fits: Drain Plumbing
Models: 100/200/400/500/700 Series

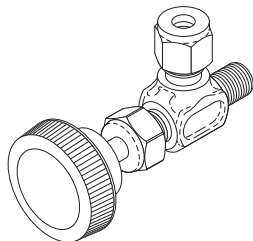

RPI Part #CSV106
OEM Part #11929

MINI VALVE

- Material: Brass body, PTFE seals
- Size: 1/8" MPT inlet x 1/8" compression tube outlet

Fits: Drain Plumbing
Models: 100/400/500/700/3500 series

RPI Part #CSK094
OEM Part #61301608963



SOLENOID VALVE REPAIR KIT

- Teflon® seal
- For **Black** Coil Valves
- Includes all parts as shown

Fits/Models:
– 400/500/700 Series & 800-42": Sol-5 Cooling Water Valve and Sol-14 Secondary Drain Valve

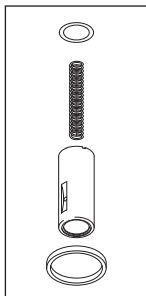

RPI Part #CSK092
OEM Part # (No OEM Part # Available)



SOLENOID VALVE REPAIR KIT

- Fits valve's upper section and manual override body
- Viton® seals
- For **Black** Coil Valves
- Includes all parts as shown
- Now you can repair the valve with this one-of-kind RPI valve repair kit. It's the RPI Advantage!

• Also available: Solenoid Valve Repair Kit (RPI Part #CSK096) - Fits bottom section

Fits/Models:
– 400/500/700 Series & 800-42": Sol-6 Water to Ejector Valve Assembly (OEM Part #61301609315)

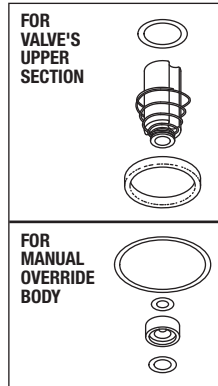

RPI Part #CSK096
OEM Part #61301609505



SOLENOID VALVE REPAIR KIT

- Fits valve's lower section
- Viton® seals
- For **Black** Coil Valves
- Includes all parts as shown
- Also available: Solenoid Valve Repair Kit (RPI Part #CSK092) - Fits top section

Fits/Models:
– 400/500/700 Series & 800-42": Sol-6 Water to Ejector Valve Assembly (OEM Part #61301609315)

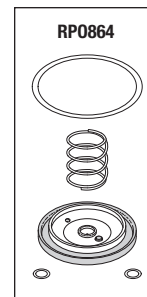

RPI Part #CSK107
OEM Part #61301608965



SOLENOID VALVE REPAIR KIT

- Brass body with Teflon® seal
- For **Black** Coil Valves
- Includes all parts as shown

Fits/Models:
– 700 Series; 800-42" & 800-76": Sol-2 Chamber Drain (Pneumatic) Valve Assembly

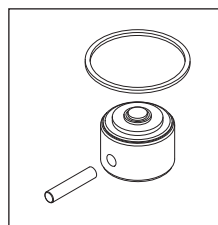

RPI Part #CSK108
OEM Part #61301609451



SOLENOID VALVE REPAIR KIT

- Viton® seal
- For **Black** Coil Valves
- Includes all parts as shown

Fits/Models:
– 400/500 Series: Sol-3 Air-In (Black Coil) Valve Assembly

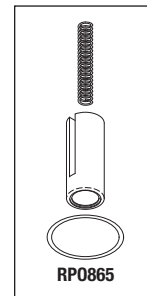

replacement parts industries, inc.

CALL (800) 221-9723 • FAX (818) 882-7028 • EMAIL order@riparts.com • WEBSITE www.riparts.com

The above parts are manufactured by Replacement Parts Industries, Inc. to fit Getinge/Castle equipment. All product names used in this document are trademarks or registered trademarks of their respective holders. Show 09/14

Check Valves & Repair Kit

RPI Part #CSV073
OEM Part #513361

CHECK VALVE (3/8")

- 3/8" FPT
- Material: Brass body; EPDM seal
- Cracking pressure: 0.5 PSI
- Also available: Check Valve Rebuild Kit (RPI Part #CSK066)

Fits: Door Seal Line, and Drain & Vent Dump Lines

Models: 100/200/400/500/700 Series, 800-42" & 800-76"

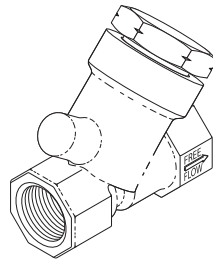

RPI Part #CSV071
OEM Part #513363

CHECK VALVE (3/4")

- 3/4" FPT
- Material: Brass body; EPDM seal
- Cracking pressure: 0.5 PSI
- Also available: Check Valve Rebuild Kit (RPI Part #CSK066)

Fits: Air Lines and Steam Lines

Fits/Models: 100/200/400/500/700 Series, 800-42", 800-76" & 4200MPS:

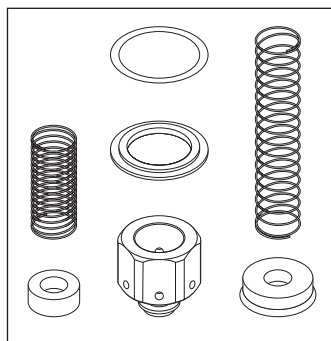
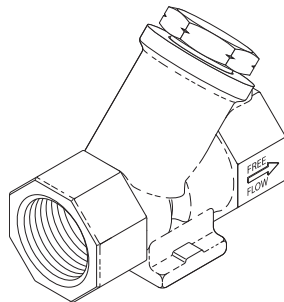

RPI Part #CSK066
OEM Part #513369

CHECK VALVE REPAIR KIT

- For 1/2", 3/8" or 3/4" style valve
- Material: Viton® O-ring; Stainless steel springs and retainer; Brass disc holder
- Includes all parts as shown
- This Kit includes two different seat and spring sets for two different applications

Fits: Check Valve (3/8") (RPI Part #CSV073/OEM Part #513361), Check Valve (3/4") (RPI Part #CSV071/OEM Part #513363), and Check Valve (1/2") (OEM Part #513362)

Models: 100/200/400/500/700/3500/6900 Series, 800-42", 800-76", 3622, 3633 & 4200MPS

Filter, Air-In

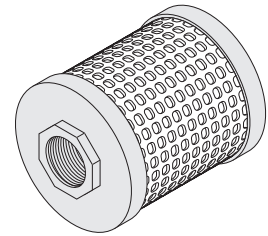

RPI Part #CSF052
OEM Part #61301600303

FILTER, AIR-IN

- 2.84" OD x 3.10" lg.
- 3/4" FPT
- 0.03 micron HEPA media

Fits: Air Supply Line

Models: 100/200/400/500/700/800/3500/3600 Series, 4200MPS & 6900AMPS

Safety Valves

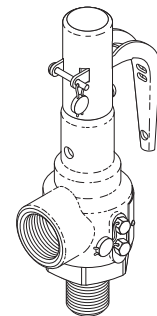

RPI Part #CSV084
OEM Part #61301608100

SAFETY VALVE (45 PSI)

- 1/2" MPT x 1/2" FPT
- Material: Bronze body; EPDM seal

Fits: Chamber Jacket

Models: 400/500/700 Series

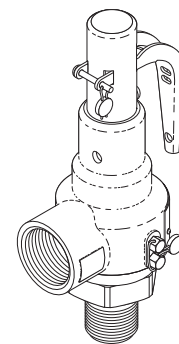

RPI Part #CSV085
OEM Part #61301601576

SAFETY VALVE (45 PSI)

- 3/4" MPT x 3/4" FPT
- Material: Bronze body; EPDM seal

Fits: Chamber Jacket

Models: 200 Series, 800-42" & 800-76"

More Solenoid Valve Repair Kits

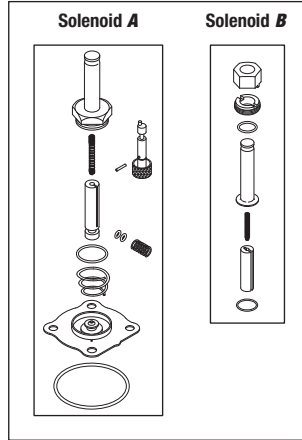

RPI Part #CSK019
OEM Part #518018/61301601738

DUAL SOLENOID VALVE REPAIR KIT

- Repair Kit for use with Sol-5 & Sol-6 (Valve No. 517356) **only**
- For **Green** Coil Valves
- Includes all parts as shown
- Includes:
 - Solenoid "A": Diaphragm style repair kit, EPDM seal and
 - Solenoid "B": Piston style valve, PTFE seal

Fits/Models:

- 100 Series: (Sol-5 Water to Drain/Ejector & Sol-6 Water to Drain/Ejector);
- 200 Series: (Sol-5 Water to Drain/Ejector & Sol-6 Water to Drain/Ejector);
- 400 Series: (Sol-5 Water to Drain/Ejector & Sol-6 Water to Drain/Ejector);
- 500 Series: (Sol-5 Water to Drain/Ejector & Sol-6 Water to Drain/Ejector);
- 700 Series: (Sol-5 Water to Drain/Ejector & Sol-6 Water to Drain/Ejector);
- 3522: (Sol-5 Slow Exhaust & Sol-6 Vac-Water);
- 3533: (Sol-5 Slow Exhaust & Sol-6 Vac-Water);
- 3622: (Sol-5 Slow Exhaust & Sol-6 Vac-Water);
- 3623: (Sol-5 Slow Exhaust & Sol-6 Vac-Water);
- 3633: (Sol-5 Slow Exhaust & Sol-6 Vac-Water)

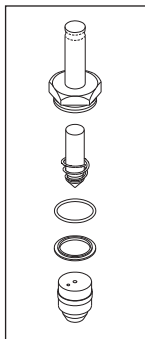

RPI Part #AMK177
OEM Part #61301601739

SOLENOID VALVE REPAIR KIT

- PTFE seal
- Includes all parts as shown

Fits/Models:

- 100 Series: Sol-1 Steam to Chamber & Sol-4 Multitherm Valve;
- 400 Series: Sol-1 Steam to Chamber, Sol-8 Steam to Jacket, Sol-10 Door Seal/Unseal & Sol-12 Door Seal/Unseal;
- 500 Series: Sol-1 Steam to Chamber, Sol-8 Steam to Jacket, Sol-10 Door Seal/Unseal & Sol-12 Door Seal/Unseal;
- 700 Series: Sol-10 Door Seal/Unseal & Sol-12 Door Seal/Unseal

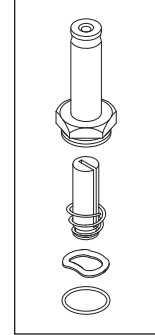

RPI Part #CSK018
OEM Part #517295/61301608453

SOLENOID VALVE REPAIR KIT

- Viton® seal
- For **Green** Coil Valves
- Includes all parts as shown

Fits/Models:

- 400 Series: Sol-3 Air-In;
- 500 Series: Sol-3 Air-In;
- 3523: Sol-3 Air-In;
- 3533: Sol-3 Air-In

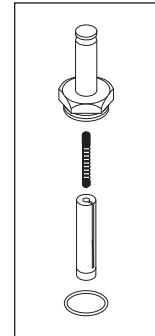

RPI Part #CSK020
OEM Part #517298/61301601737 (Green Coil)

SOLENOID VALVE REPAIR KIT

- EPDM seal
- For **Green** Coil Valves
- Includes all parts as shown

Fits/Models:

- 100/400/500 Series & 3523: Sol-5 Slow Exhaust;
- 400 Series: Sol-5 Slow Exhaust;
- 500 Series: Sol-5 Slow Exhaust

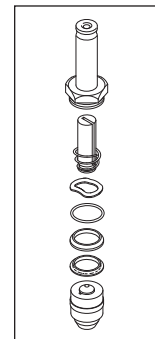

RPI Part #CSK025
OEM Part #54186

SOLENOID VALVE REPAIR KIT

- PTFE seal
- For **Green** Coil Valves
- Includes all parts as shown

Fits/Models:

- 200 Series: (Sol-8 Steam to Jacket);
- 700 Series: (Sol-1 Steam to Chamber & Sol-8 Steam to Jacket);
- 800-42": (Sol-1 Steam to Chamber, Sol-8 Steam to Jacket & Sol-10/12 Door Seal/Unseal);
- 800-76": (Sol-10/12 Door Seal/Unseal)



replacement parts industries, inc.

20338 Corisco Street • Chatsworth, California • 91311

PRESORTED STANDARD
U.S. POSTAGE PAID
VAN NUYS, CA
PERMIT NO. 2399

ADDRESS SERVICES REQUESTED

LOOK!

**New Parts to fit
Getinge/Castle
Bulk Sterilizers!**

Steam Traps & Repair Kits

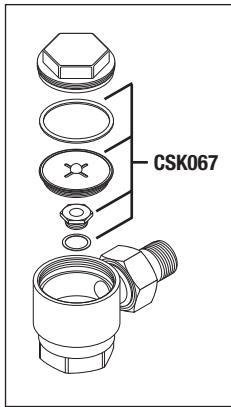

RPI Part #CST059
OEM Part #61301602492

STEAM TRAP

- 1/2" MPT x 1/2" FPT
- Material: Brass body; stainless steel seat
- Max. rated pressure: 125 PSI;
Max. operating temperature: 450°F
- Includes all parts as shown
- Also available: Steam Trap Rebuild Kit (RPI Part #CSK067)

Fits: Jacket or Chamber to Jacket

Models: 100/200/400/500/700/3500 Series, 800-42", 800-76", 3622, & 3633

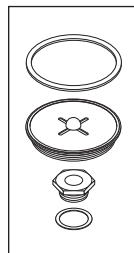

RPI Part #CSK067
OEM Part # (No OEM Part # Available)

STEAM TRAP REBUILD KIT

- Includes all parts as shown
- Also available: Steam Trap (RPI Part #CST059)

Fits: 1/2" Valve

Models: 100/200/400/500/700/3500 Series, 800-42", 800-76", 3622, & 3633

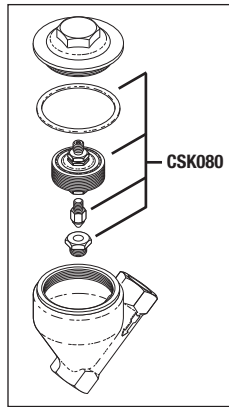

RPI Part #CST079
OEM Part #61301603751

STEAM TRAP

- 3/4" FPT
- Material: Brass body; Stainless steel valve stem and seat
- Max operating pressure: 200 PSI
- Max allowable temperature: 400°F
- Includes all parts as shown
- Also available: Steam Trap Rebuild Kit (RPI Part #CSK080)

Fits: Steam Line

Models: 200 Series & 800-76"

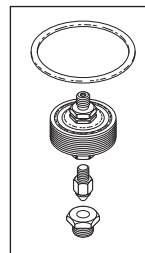

RPI Part #CSK080
OEM Part #61301603755

STEAM TRAP REBUILD KIT

- Material: Stainless steel valve stem and seat
- Includes all parts as shown
- Also available: Steam Trap (RPI Part #CST079)

Fits: Steam Trap

Models: 200 Series & 800-76"

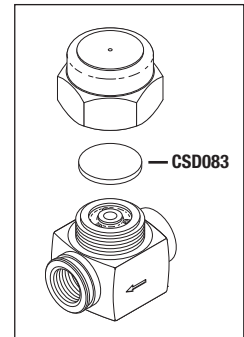

RPI Part #CST082
OEM Part #68722

STEAM TRAP

- 3/8" FPT
- Material: Stainless steel body and disc
- Max operating pressure: 600 PSI;
Minimum operating pressure: 3.5 PSI
- Max allowable temperature: 800°F
- Includes all parts as shown
- Also available: Replacement Disc (RPI Part #CSD083)

Fits: Steam Line

Models: 400/500/700 Series & 4200MPS



(Top View Shown)

RPI Part #CSD083
OEM Part # (No OEM Part # Available)

REPLACEMENT DISC

- Material: Stainless steel
- Also available: Steam Trap (RPI Part #CST082)

Fits: Steam Trap

Models: 400/500/700 Series & 4200MPS