



## New and Existing Parts to fit AIR TECHNIQUES DENTAL FILM PROCESSORS

### Peri-Pro® & Peri-Pro II®

**Now Includes**

"L" Transfer Arm Bushings, "U" Transfer Drive Bushings & the Rubber Bumper!

RPI Part #ATK629  
OEM Part #90988

**TRANSPORT REPAIR KIT**

• Kit includes quantities as noted  
**Fits:** Transport Assembly  
**Models:** Peri-Pro & Peri-Pro II

**Now Includes**

the Rubber Bumper!

RPI Part #ATK628  
OEM Part # (No OEM # Available)

**SHUTTER RELEASE REPAIR KIT**

• Kit includes (1) of each part as shown  
**Fits:** Transport Assembly  
**Models:** Peri-Pro & Peri-Pro II

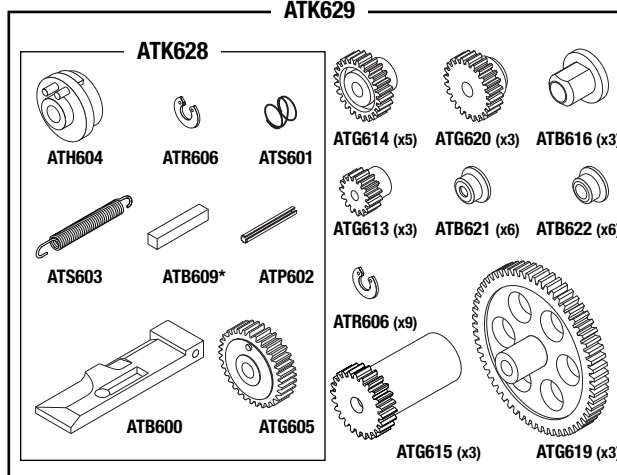

All parts shown are also sold separately!

\* Secure Rubber Bumper in place using Silicone Gasket Maker 598 (RPI Part #RPS639)

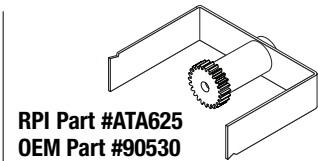

RPI Part #ATA625  
OEM Part #90530

**"U" TRANSFER ARM ASSEMBLY**

• "U" Transfer Arm (RPI Part #ATA618) also sold separately  
**Fits:** Transport Assembly  
**Models:** Peri-Pro & Peri-Pro II

**Now Includes**

10 Per Package!

RPI Part #ATR606  
OEM Part #90543

**PLASTIC SNAP RING**

**Fits:** Idler Gear Shaft and Transfer Drive Shaft  
**Models:** Peri-Pro & Peri-Pro II

### Peri-Pro III®

RPI Part #ATK663  
OEM Part #94988

**TRANSPORT REPAIR KIT**

• Kit includes quantities as noted  
**Fits:** Transport Assembly  
**Models:** Peri-Pro III

RPI Part #ATK664  
OEM Part # (No OEM # Available)

**SHUTTER RELEASE REPAIR KIT**

• Kit includes (1) of each part as shown  
**Fits:** Transport Assembly  
**Models:** Peri-Pro III

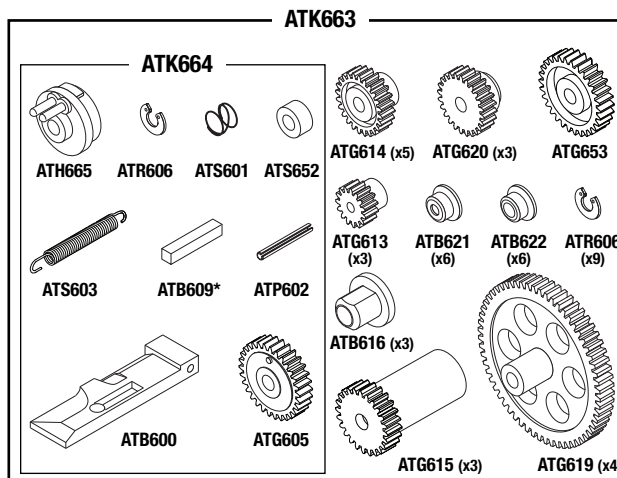

All parts shown are also sold separately!

\* Secure Rubber Bumper in place using Silicone Gasket Maker 598 (RPI Part #RPS639)

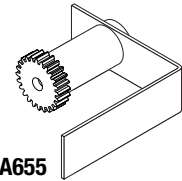

RPI Part #ATA655  
OEM Part #94530

**"L" TRANSFER ARM ASSEMBLY**

**Fits:** Transport Assembly  
**Models:** Peri-Pro III

**Now Includes**

10 Per Package!

RPI Part #ATR606  
OEM Part #90543

**PLASTIC SNAP RING**

**Fits:** Idler Gear Shaft and Transfer Drive Shaft  
**Models:** Peri-Pro III

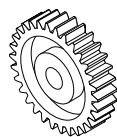

RPI Part #ATG653  
OEM Part #94501

**SPEED REDUCER GEAR**

**Fits:** On top of Developer Gear on Transport  
**Models:** Peri-Pro III

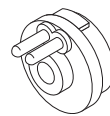

RPI Part #ATH665  
OEM Part #94540

**HUB & PIN ASSEMBLY**

**Fits:** Idler Gear Shaft  
**Models:** Peri-Pro III



RPI Part #ATS652  
OEM Part # (No OEM # Available)

**SPACER**

**Fits:** Hub and Timer Gear Shaft  
**Models:** Peri-Pro III

# Dental Equipment



Models: Peri-Pro®, Peri-Pro II® & Peri-Pro III®

**RPI Part #ATS673**  
**OEM Part #94269** (Black)  
 & **90262** (White no longer manufactured)

**POWER SWITCH**

- Color: illuminated amber lens; black body

**Fits:** Switch Plate

**Models:** Peri-Pro (S/N 15000 and above), Peri-Pro II (S/N 15143 and above) & Peri-Pro III

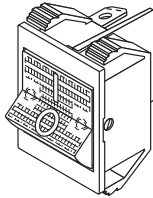

**RPI Part #ATS674**  
**New OEM Part #94977**  
**Old OEM Part #94266**

**PROCESS SWITCH**

- Color: illuminated green lens; black body

**Fits:** Switch Plate

**Models:** Peri-Pro II (S/N 15143 and above) & Peri-Pro III

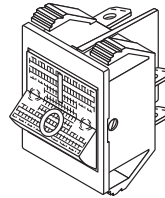

**RPI Part #ATS636**  
**OEM Part #90221**

**POWER SWITCH ASSEMBLY**

**Fits:** Switch Plate

**Model:** Peri-Pro (Serial #14999 and below)

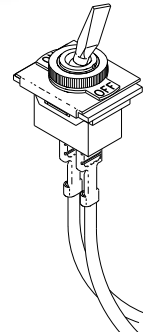

**RPI Part #ATS671**  
**OEM Part #116521**

**PROCESS SWITCH**

- Color: white body

**Fits:** Switch Plate

**Models:** Peri-Pro II (S/N 15142 and below)

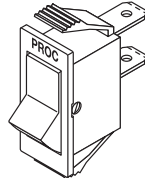

**RPI Part #ATS672**  
**OEM Part #116520**

**POWER SWITCH**

- Color: white body

**Fits:** Switch Plate

**Models:** Peri-Pro II (S/N 15142 and below)

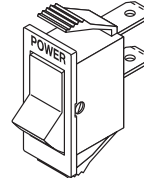

**RPI Part #ATV661**  
**OEM Part #94994**

**DRAIN VALVE**

**Fits:** Peri-Pro III Base

**Models:** Peri-Pro III

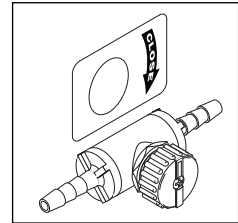

**RPI Part #ATR658**  
**OEM Part #90810**

**FILM RECEPTACLE**

**Fits:** Outer Cover

**Models:** Peri-Pro, Peri-Pro II & Peri-Pro III

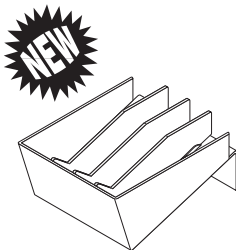

**RPI Part #ATG659**  
**OEM Part #90555**

**FILM INLET GRILLE**

**Fits:** Film entrance on Transport Assembly

**Models:** Peri-Pro, Peri-Pro II & Peri-Pro III

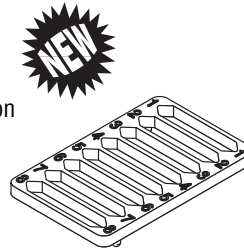

**RPI Part #RPO304**  
**OEM Part #60604**

**O-RING - 12/pkg**

**Fits:** Water Tank Drain

**Models:** Peri-Pro III



Actual Size

**RPI Part #RPH638**  
**OEM Part #90219**

**FUSE HOLDER (MAIN)**

**Fits:** Back panel

**Models:** Peri-Pro, Peri-Pro II & Peri-Pro III

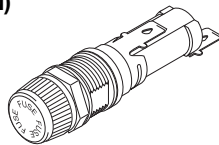

**RPI Part #RPF051**  
**OEM Part #90265**

**FUSE (5A, 250V) - 5/pkg**

**Fits:** Fuse Holder

**Models:** Peri-Pro, Peri-Pro II & Peri-Pro III

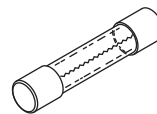

**RPI Part #RPT604**  
**OEM Part #94124**

**DRAIN TUBING**

- Sold by the foot (reel not included)

**Fits:** Drain Valve

**Models:** Peri-Pro III

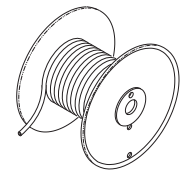

**RPI Part #ATA617**  
**OEM Part #90520**

**"L" TRANSFER ARM ASSEMBLY**

**Fits:** "L" Transfer Arm

**Models:** Peri-Pro, Peri-Pro II & Peri-Pro III

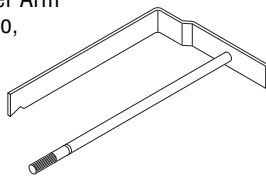

**RPI Part #ATP610**  
**OEM Part #90505**

**TOP PLATE PIN**

**Fits:** Track Plate

**Models:** Peri-Pro, Peri-Pro II & Peri-Pro III

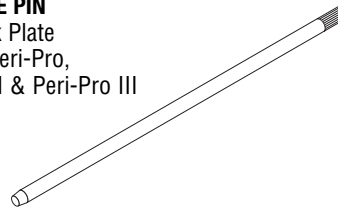

**RPI Part #ATS607**  
**OEM Part #90502**

**IDLER GEAR SHAFT**

**Fits:** Transport Assembly

**Models:** Peri-Pro, Peri-Pro II & Peri-Pro III

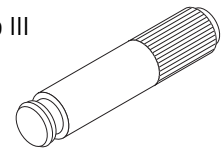

**RPI Part #ATS623**  
**OEM Part #90504**

**TRANSFER ARM SHAFT**

**Fits:** Transport Assembly

**Models:** Peri-Pro, Peri-Pro II & Peri-Pro III

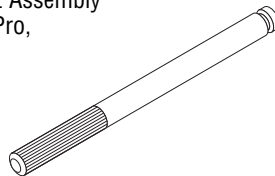

**RPI Part #ATS624**  
**OEM Part #90506**

**TRANSFER DRIVE SHAFT**

**Fits:** Transport Assembly

**Models:** Peri-Pro & Peri-Pro II

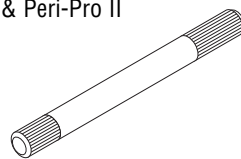

**RPI Part #ATA626**  
**OEM Part #90505**

**"U" TRANSFER DRIVE ASSEMBLY**

- Includes all parts as shown

**Fits:** Transport Assembly

**Models:** Peri-Pro, Peri-Pro II & Peri-Pro III

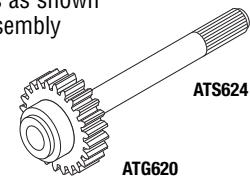

ATS624

ATG620



**RPI Part #ATH634**  
**New OEM Part #90610**  
**Old OEM Part #90228**

### HEATING ELEMENT (DRYER)

- Includes mounting hardware
- Use Thermal Fuse (RPI Part #ATF651)

**Fits:** Dryer Section  
**Models:** Peri-Pro & Peri-Pro II

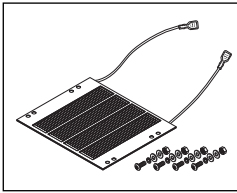

**RPI Part #ATH648**  
**OEM Part #94630**

### HEATING ELEMENT (DRYER)

- Includes mounting hardware
- Use Thermal Fuse (RPI Part #ATF649)

**Fits:** Dryer housing  
**Model:** Peri-Pro III

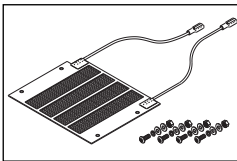

**RPI Part #ATM632**  
**OEM Part #90880**

### DRYER FAN & MOTOR ASSEMBLY

**Fits:** Base Bottom Plate  
**Models:** Peri-Pro, Peri-Pro II & Peri-Pro III

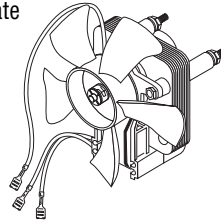

**RPI Part #ATF633**  
**OEM Part #90102**

### DRYER FAN BLADE

**Fits:** Fan and Motor Assembly  
**Models:** Peri-Pro, Peri-Pro II & Peri-Pro III

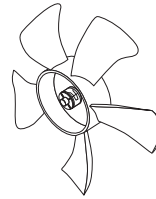

**RPI Part #ATH660**  
**OEM Part #94970**

### HEATER PLATE

**Fits:** Base Plate  
**Models:** Peri-Pro III

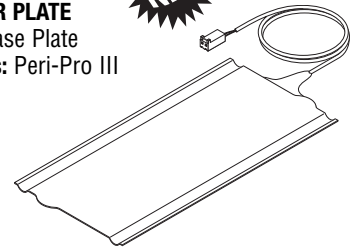

**RPI Part #ATT662**  
**OEM Part #94975**

### THERMISTOR PROBE

**Fits:** Thermistor Arm  
**Models:** Peri-Pro III

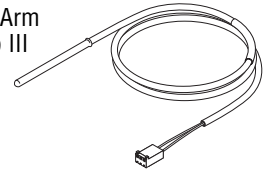

**RPI Part #ATT635**  
**OEM Part #90210**

### THERMOSTAT/BACKET ASSEMBLY

**Model:** Peri-Pro  
(Serial #20479 & below)

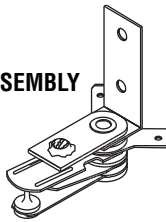

**RPI Part #PCB134**  
**OEM Part #117327**

### ELECTRICAL TERMINAL BUSHING

**Fits:** Switch Plate (Thermo Fuse)  
**Models:** Peri Pro (Serial #20480 and above), Peri Pro II & Peri Pro III

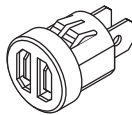

**Service Tip:** When the Peri-Pro III hit the market a few years ago, AirTechniques introduced a new Thermal Fuse that would work with all three models - Peri-Pro, Peri-Pro II & Peri-Pro III. However, we came to find out that this "common" fuse did not work with all three models. In fact, many of our customers found that if this fuse was used in the Peri-Pro and Peri-Pro II, it would open prematurely. As a result, here's what RPI recommends:

**RPI Part #ATF651**  
**OEM Part #90278**

### THERMAL FUSE (109°C)

- Use with Heating Element (Dryer) (RPI Part #ATH634)

**Fits:** Electrical Terminal Bushing (RPI Part #PCB134)

**Model:** Peri-Pro & Peri-Pro II

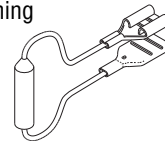

**RPI Part #ATF649**  
**OEM Part #94278**

### THERMAL FUSE (98°C)

- Use with Heating Element (Dryer) (RPI Part #ATH648)

**Fits:** Electrical Terminal bushing (RPI Part #PCB134)

**Model:** Peri-Pro III

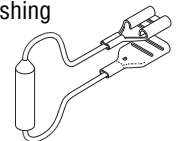

**RPI Part #ATM630**  
**OEM Part #90147**

### MAIN DRIVE MOTOR

**Fits:** Spacer Plate  
**Models:** Peri-Pro, Peri-Pro II & Peri-Pro III

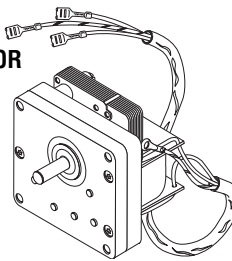

**RPI Part #ATG627**  
**OEM Part #90996**

### MAIN DRIVE GEAR

**Fits:** Motor Drive Shaft  
**Model:** Peri-Pro II only

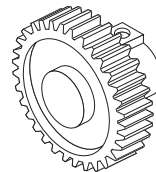

**RPI Part #ATM631**  
**OEM Part #90223**

### DRYER DRIVE MOTOR

**Fits:** Switch Plate  
**Model:** Peri-Pro & Peri-Pro II



**RPI Part #ATG611**  
**OEM Part #90995**

### MAIN DRIVE GEAR

**Fits:** Main Drive Motor  
**Model:** Peri-Pro only

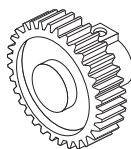

**RPI Part #ATG650**  
**OEM Part #94995**

### MAIN DRIVE GEAR

**Fits:** Drive motor  
**Model:** Peri-Pro III only

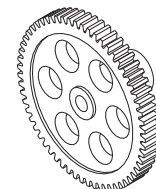

**RPI Part #ATG612**  
**OEM Part #91993**

### DRYER DRIVE GEAR

**Fits:** Dryer Drive Motor  
**Model:** Peri-Pro & Peri-Pro II

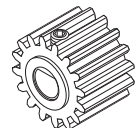

RPI PART #	OEM PART #	DESCRIPTION	PERI-PRO I	PERI-PRO II	PERI-PRO III
ATA617	90520	"L" TRANSFER ARM ASSY	•	•	•
ATA618	90564	"U" TRANSFER ARM	•	•	
ATA625	90530	"U" TRANSFER ARM ASSY	•	•	
ATA626	90550	"U" TRANSFER DRIVE ASSY	•	•	•
ATA655	94530	"L" TRANSFER ARM ASSY			•
ATB600	90548	SHUTTER RELEASE BAR	•	•	•
ATB609	90546	RUBBER BUMPER - 6/PKG	•	•	•
ATB616	90522	TRANSFER ARM BEARING - 3/PKG	•	•	•
ATB621	90523	"L" TRANSFER ARM BUSHING - 6/PKG	•	•	•
ATB622	90524	TRANSFER ARM BUSHING - 6/PKG	•	•	•
ATF633	90102	DRYER FAN BLADE	•	•	•
ATF649	94278	THERMAL FUSE (98° C)			•
ATF651	90278	THERMAL FUSE (109° C)	•	•	
ATG605	90521	TIMER GEAR	•	•	•
ATG611	90995	MAIN DRIVE GEAR	•		
ATG612	91993	DRYER DRIVE GEAR	•	•	
ATG613	90525	"L" TRANSFER ARM GEAR - 3/PKG	•	•	•
ATG614	90519	IDLER GEAR - 5/PKG	•	•	•
ATG615	90518	TRANSFER ARM GEAR - 3/PKG	•	•	•
ATG619	90517	TRANSFER ARM GEAR	•	•	•
ATG620	90516	TRANSFER GEAR - 3/PKG	•	•	•
ATG627	90996	MAIN DRIVE GEAR		•	
ATG650	94995	MAIN DRIVE GEAR			•
ATG653	94501	SPEED REDUCER GEAR			•
<b>ATG659</b>	90555	FILM INLET GRILLE	•	•	•
ATH604	90540	HUB & PIN ASSY	•	•	
ATH634	90610 (Old OEM Part #90228)	HEATING ELEMENT (DRYER)	•	•	
ATH648	94630	HEATING ELEMENT (DRYER)			•
<b>ATH660</b>	94970	HEATER PLATE			•
ATH665	94540	HUB & PIN ASSY			•
ATK628	(No OEM Part # Available)	SHUTTER RELEASE REPAIR KIT	•	•	



RPI PART #	OEM PART #	DESCRIPTION	PERI-PRO I	PERI-PRO II	PERI-PRO III
ATK629	90988	TRANSPORT REPAIR KIT	•	•	
ATK663	94988	TRANSPORT REPAIR KIT			•
ATK664	(No OEM Part # Available)	SHUTTER RELEASE REPAIR KIT			•
ATM630	90147	MAIN DRIVE MOTOR	•	•	•
ATM631	90223	DRYER DRIVE MOTOR	•	•	
ATM632	90880	DRYER FAN & MOTOR ASSY	•	•	•
ATP602	30391	SPRING PIN - 6/PKG	•	•	•
ATP610	90505	TOP PLATE PIN	•	•	•
ATR606	90543	PLASTIC SNAP RING - 10/PKG	•	•	•
<b>ATR658</b>	90810	FILM RECEPTACLE	•	•	•
ATS601	90545	COMPRESSION SPRING - 6/PKG	•	•	•
ATS603	90512	SHUTTER RETURN SPRING - 3/PKG	•	•	•
ATS607	90502	IDLER GEAR SHAFT	•	•	•
ATS623	90504	TRANSFER ARM SHAFT	•	•	•
ATS624	90506	TRANSFER DRIVE SHAFT	•	•	•
ATS636	90221	POWER SWITCH ASSY	1		
ATS652	(No OEM Part # Available)	SPACER - 3/PKG			•
ATS671	116521	PROCESS SWITCH		2	
ATS672	116520	POWER SWITCH		2	
ATS673	94269 (BLACK) & 90262 (WHITE)	POWER SWITCH	3	4	•
ATS674	94977 (Old OEM Part #94266)	PROCESS SWITCH		4	•
ATT635	90210	THERMOSTAT/BACKET ASSY	5		
ATT662	94975	THERMISTOR PROBE			•
ATV661	94994	DRAIN VALVE			•
PCB134	117327	ELECTRICAL TERMINAL BUSHING - 3/PKG	6	•	•
RPF051	90265	FUSE (5A, 250VAC) - 5/PKG	•	•	•
RPH638	90219	FUSE HOLDER (MAIN)	•	•	•
RPO304	60604	O-RING - 12/PKG			•
RPT604	94124	DRAIN TUBING			•

NEW PARTS ARE HIGHLIGHTED AND IN **BOLD TYPE**

1=Serial #14999 and below  
 5=Serial #20479 and below

2= Serial # 15142 and below  
 6=Serial #20480 and above

3=Serial #15000 and above

4=Serial #15143 and above

ADDRESS SERVICES REQUESTED

**LOOK INSIDE!**  
**NEW & EXISTING PARTS**  
**TO FIT AIR TECHNIQUES**  
**PERI-PRO, PERI-PRO II & PERI-PRO III.**