



## Introducing New Parts to fit AMSCO/STERIS Century V116 and V120 Sterilizers!

**RPI Part #AMP214**  
**OEM Part #764326-646**

**PM PACK (MISCELLANEOUS)**

- Includes:
  - (1) Check Valve (1/4") (RPI Part #AMV228);
  - (1) Filter Element (RPI Part #AME200);
  - (2) Steam Trap Assembly Repair Kit (RPI Part #AMK188);
  - (3) Check Valve (1/2") (RPI Part #AMV229);
  - (1 pkg of 5) Fuse (5A, 250V) - Time Delay (RPI Part #RPF067); and,
  - (1 pkg of 5) Fuse (4A, 250V) - Fast Acting (RPI Part #RPF050)
- All parts also sold separately

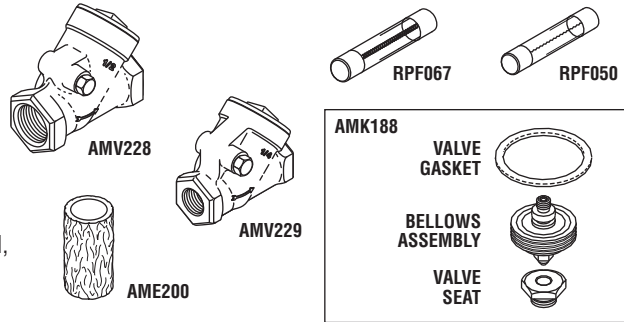

**RPI Part #AMV228**  
**OEM Part #10278-091**

**CHECK VALVE (1/4")**

- **CK14**
- Also Available: Check Valve Rebuild Kit (RPI Part #AMK230)
- Also included in PM Pack (Misc) (RPI Part #AMP214)
- Note:** CK14 is plumbed in line with Exhaust Manifold

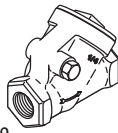

**RPI Part #AMK230**  
**OEM Part #10278-091**  
(Complete Check Valve)

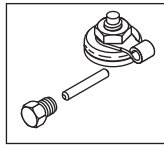

**CHECK VALVE REBUILD KIT (1/4")**

- PTFE Seat Disk (White)
- Kit includes all parts as shown
- Fits:** Check Valve (1/4") / CK14

**RPI Part #AMV229**  
**OEM Part #150822-354**

**CHECK VALVE (1/2")**

- **CK1, CK2 & CK3**
- Also Available: Check Valve Rebuild Kit (RPI Part #AMK231)
- Also included in PM Pack (Misc) (RPI Part #AMP214)
- Note:** CK1 & CK2 are plumbed between Water Ejector and Waste Funnel; and, CK3 is plumbed between TR-2 Steam Trap and CK14 Check Valve



**RPI Part #AMK231**  
**OEM Part #150822-354**  
(Complete Check Valve)

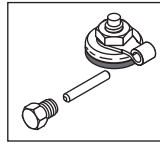

**CHECK VALVE REBUILD KIT (1/2")**

- Buna-N Seat Disk (Black)
- Kit includes all parts as shown
- Fits:** Check Valve (1/2") / CK1, CK2 & CK3

**RPI Part #AME200**  
**OEM Part #129360-802**

**FILTER ELEMENT**

- 1.40" OD x 2.50" LG
- Also included in PM Pack (Misc) (RPI Part #AMP214)
- Fits:** Air Filter Housing



**RPI Part #AMV206**  
**OEM Part #93918-066**

**BALL VALVE (3/4")**

- "Water Supply" handle
- Fits:** Mounted below chamber door

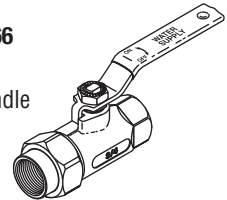

**RPI Part #AMV205**  
**OEM Part #93918-212**

**BALL VALVE (1/4")**

- "Emergency Exhaust" handle
- Fits:** Mounted above chamber door

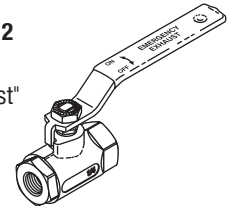

**RPI Part #AMS202**  
**OEM Part #150828-459**

**STRAINER (1/2")**

- Includes: Strainer Element (1/2") (RPI Part #AMK232)
- Fits:** Plumbed in line with TR-2 Steam Trap

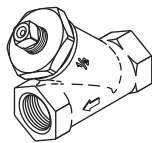

**RPI Part #AMK232**  
**OEM Part #150828-459**  
(Complete 1/2" Strainer)

**STRAINER ELEMENT (1/2")**

- .62" OD x 1.64" Long
- 80 Mesh S.S. screen with PTFE O-ring
- Also Available: Strainer (1/2") (RPI Part #AMS202)
- Fits:** Strainer (1/2")

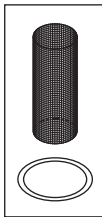

**RPI Part #AMS203**  
**OEM Part #47708-091**

**STRAINER (3/4")**

- Includes: Strainer Element (3/4") (RPI Part #AME233)
- Also Available: Strainer Element (3/4") (RPI Part #AME233)
- Fits:** Plumbed in line between Water Manifold and M1 Ball Valve

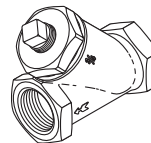

**RPI Part #AME233**  
**OEM Part #47708-091**  
(Complete 3/4" Strainer)

**STRAINER ELEMENT (3/4")**

- .88" OD x 1.76" Long
- 24 Mesh S.S. screen
- Also Available: Strainer (3/4") (RPI Part #AMS203)
- Fits:** Strainer (3/4")



**RPI Part #AMV201**  
**OEM Part #93918-013**

**SAFETY VALVE (50 PSI)**

- 1/2 MPT Inlet x 3/4 FPT Outlet
- Cracking Pressure: 50 PSI
- Fits:** Chamber assembly

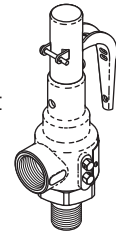

**RPI Part #AMX218**  
**OEM Part #136809-844**

**HEAT EXCHANGER**

- 12.20" x 4.37" x 2.05"
- Rated for up to 450 PSI and 437° F Steam

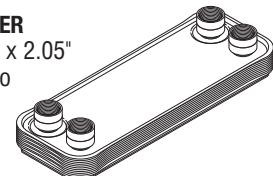

# Bulk Sterilizers and Sterilizer Washers

Models: Century V116 and V120 (continued)

**RPI Part #AMK111**  
**OEM Part**  
**#P754359-001**

**3/8" PRV KIT**

- Includes all parts as shown
  - All parts also sold separately - see Chart below
- Fits:** PM for PR1

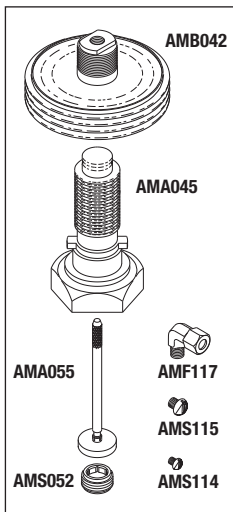

**RPI Part #AMT187**  
**OEM Part #P129222-001**

**STEAM TRAP ASSEMBLY (1/2" VALVE)**

- Includes all parts as shown
  - Also available:
- Steam Trap Assembly Repair Kit (RPI Part #AMK188)
- Fits:** Jacket drain assembly

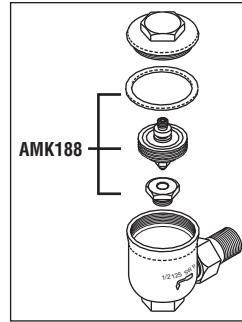

**RPI Part #AMK188**  
**OEM Part #P764080-001/764080-091**

**STEAM TRAP ASSEMBLY REPAIR KIT**

- Includes all parts as shown
  - Also available: Steam Trap Assembly (RPI Part #AMT187)
  - Also included in PM Pack (Misc) (RPI Part #AMP214)
- Fits:** Steam trap valve and Exhaust manifold

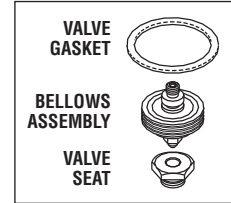

**RPI Part #CSK050**  
**OEM Part #P764326-621**

**SOLENOID VALVE REPAIR KIT**

- Includes all parts as shown
  - Diaphragm style repair kit
- Fits:** S-4 Water Supply & S-7 Manifold

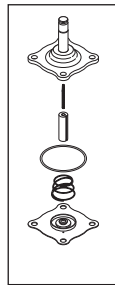

**RPI Part #AMK183**  
**OEM Part #P764187-001 (S26) & 764326-482 (S3)**

**SOLENOID VALVE REPAIR KIT**

- Includes all parts as shown
  - Diaphragm style repair kit
- Fits:** Exhaust manifold

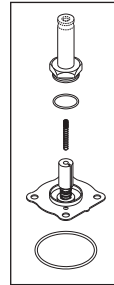

**RPI Part #RPF050**  
**OEM Part #764317-825**

**FUSE (4A, 250V) - FAST ACTING (5/pkg)**  
**Fits:** Power Supply F1 and F2 Fuse

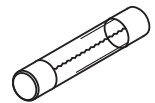

**RPI Part #RPF067**  
**OEM Part #764317-463**

**FUSE (5A, 250V) - TIME DELAY (5/pkg)**  
**Fits:** Control Box F3 Fuse

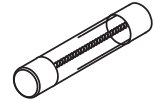

**RPI Part #RPT113**  
**MAX REGISTER THERMOMETER**

- Accuracy Rating:  $\pm 1$  Division ( $\pm 2^\circ\text{F}$ )
- Range: 150°F to 350°F



RPI PART #	OEM PART #	DESCRIPTION	NOTES
AMA045	P026836-091	3/8" BONNET & SYLPHON	
AMA055	P028267-091	3/8" VALVE STEM ASSEMBLY	
AMB042	P035880-091	BELLOWS	
AME200	129360-802	FILTER ELEMENT	
AME233	47708-091 (Complete 3/4" Strainer)	STRAINER ELEMENT (3/4")	
AMF117	P006750-044	90 DEGREE ELBOW ADAPTOR	
AMK111	P754359-001	3/8" PRV KIT	
AMK183	764326-482 (S3) & P764187-001 (S26)	SOLENOID VALVE REPAIR KIT	
AMK188	P764080-001 / 764080-091	STEAM TRAP ASSEMBLY REPAIR KIT	
AMK230	10278-091 (Complete Check Valve)	CK VLV REBUILD KIT (1/4")	
AMK231	150822-354 (Complete Check Valve)	CK VLV REBUILD KIT (1/2")	
AMK232	150828-459 (Complete 1/2" Strainer)	STRAINER ELEMENT (1/2")	
AMP214	764326-646	PM PACK (MISCELLANEOUS)	
AMS052	P005685-061	3/8" VALVE SEAT	
AMS114	P009276-041	SLOTTED ROUND HEAD SCREW (25/PKG)	
AMS115	P003969-041	SLOTTED ROUND HEAD SCREW (25/PKG)	
AMS202	150828-459	STRAINER (1/2")	
AMS203	47708-091	STRAINER (3/4")	
AMT187	P129222-001	STEAM TRAP ASSEMBLY	
AMV201	93918-013	SAFETY VALVE (50 PSI)	
AMV205	93918-212	BALL VALVE (1/4")	
AMV206	93918-066	BALL VALVE (3/4")	
AMV228	10278-091	CHECK VALVE (1/4")	
AMV229	150822-354	CHECK VALVE (1/2")	
AMX218	136809-844	HEAT EXCHANGER	
CSK050	P764326-621	SOLENOID VALVE REPAIR KIT	
RPF050	764317-825	FUSE (4A, 250V) - FAST ACTING (5/PKG)	
RPF067	764317-463	FUSE (5A, 250V) - TIME DELAY (5/PKG)	
RPT113	No OEM Part # Available	MAX REGISTER THERMOMETER	