



LID ASSEMBLY & VALVES TO FIT STERIS SYSTEM 1 ...

Models 89A1, 90A1, 90A2, 90B1, 99A1 & 99A2

RPI Part #SSL043
OEM Part #200288FS

LID ASSEMBLY

Lid Assembly is refurbished and retro-fitted with improvements for better performance:

- Metal core is bead-blasted removing paint and debris • Core is coated and sealed with a two-part chemical compound, NOT painted • Insert is made from highly durable plastic • Fill block has been redesigned for longer life • Tubing running from the lid to the float block is formed from stainless steel, not chrome-plated copper or complete plastic hose • White rubber gasket on the inner lid is larger, creating a larger sealing surface and is aligned with the inflatable seal to extend the life of the processing trays • Adhesives used during assembly are stronger than the OEM adhesives • All new materials used are FDA approved.

Models: System 1 Models 89A1, 90B1, 90A1, 90A2, 99A1 & 99A2

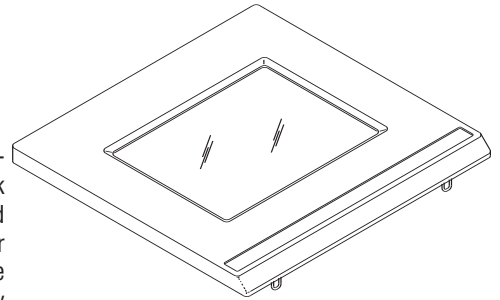

Return the old Lid Assembly to RPI for a \$150 credit! Contact RPI for details.

FITS SYSTEM 1 Models 90A1, 90A2, 99A1 & 99A2

RPI Part #SSV017
OEM Part #200188

SOL 1 SOLENOID VALVE

- 24 Volt
- Fits: Air Manifold Assembly

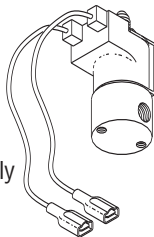

RPI Part #SSV019
OEM Part #200189

SOL 2, 3 & 4 SOLENOID VALVE SUB-ASSEMBLY

- 24 Volt
- SOL-2 Seal Release
- SOL-3 Circulation Pinch Valve
- SOL-4 Drain Pinch Valve
- Fits: Air Manifold Assembly

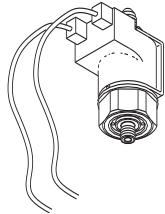

RPI Part #SSV024
OEM Part #200154

SOL 5 & 7 DUAL WATER INLET VALVE

- 24 Volt
- Mounts to machine chassis

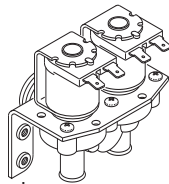

RPI Part #SSV021
OEM Part #200534

SOL 8 SOLENOID VALVE ASSEMBLY

- 24 Volt
- Includes fittings
- Fits: Sterile filter housing

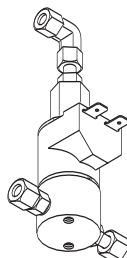

FITS SYSTEM 1 Models 89A1 & 90B1

RPI Part #SSV018
OEM Part #500023

SOL 1 SOLENOID VALVE

- 120 Volt
- Includes (2) 1/4" insulated terminals
- Fits: Air Manifold Assembly

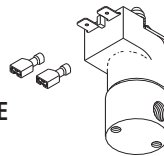

RPI Part #SSV020
OEM Part #500016

SOL 2, 3 & 4 SOLENOID VALVE SUB-ASSEMBLY

- 120 Volt
- Includes (2) 1/4" insulated terminals
- SOL-2 Seal Release
- SOL-3 Circulation Pinch Valve
- SOL-4 Drain Pinch Valve
- Fits: Air Manifold Assembly

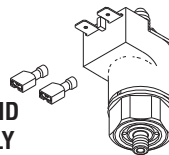

RPI Part #SSV023
OEM Part #200051

SOL 5 & 7 DUAL WATER INLET VALVE

- 120V
- Mounts to machine chassis

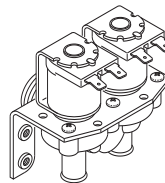

RPI Part #SSV022
OEM Part #200533

SOL 8 SOLENOID VALVE ASSEMBLY

- 120 Volt
- Includes fittings
- Fits: Sterile filter housing

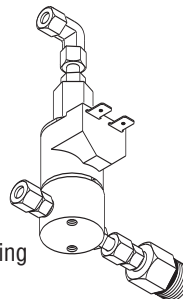

FITS SYSTEM 1 All Models

RPI Part #SST033
OEM Part #500019

LS-1 THERMAL CUT OFF SWITCH

- Includes Heat Sink Compound (RPI Part #RPC464)
- Opens @ 50°C (122°F); Manual reset
- Fits: Heater Housing

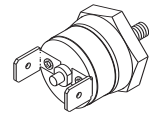

RPI Part #RPO307
OEM Part #450617

O-RING

- 12 per package
- Material: EPDM
- Hardness: 70 Duro
- .114 ID x .254 OD x .070 C/S
- Fits: Air Manifold Assembly



RPI Part #RPO450
OEM Part #45621

O-RING

- 6 per package
- Material: Red Silicone
- Hardness: 50 Duro
- .547 ID x .649 OD x .051 C/S
- Fits: CK 2 & 3 on Float Block Assembly

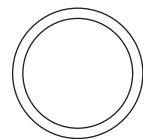

RPI has more parts to fit System 1 including check valves, filters, pinch sleeves and the inflatable seal. Visit our website, www.rpiparts.com



replacement parts industries, inc.

CALL (800) 221-9723 • FAX (818) 882-7028 • EMAIL order@rpiparts.com • WEBSITE www.rpiparts.com

† Above parts are manufactured by Replacement Parts Industries, Inc. to fit Steris equipment. All product names used in this document are trademarks or registered trademarks of their respective holders. For Website from 04/05 Flyer.