



“The Alternate Source ”®

**THE LEADER IN REPLACEMENT PARTS
FOR HEALTHCARE EQUIPMENT**

Since RPI was founded in 1972, it has been our mission to be THE ALTERNATE SOURCE for replacement parts for hospital, laboratory, veterinary, physician and dental equipment service organizations by providing parts and service that consistently exceed our customers' expectations for quality, at competitive prices.

replacement parts industries, inc.

625 Cochran Street • Simi Valley, California 93065

CALL (800) 221-9723 or (818) 882-8611 • FAX (818) 882-7028 • E-MAIL order@rpiparts.com • WEBSITE www.rpiparts.com

General Information

YOUR CUSTOMER ACCOUNT NUMBER

For fastest service, please have your Customer Account Number available whenever you call and please include it on all correspondence.

Customer Account Number _____

IT'S SO EASY TO PLACE YOUR ORDER

CALL (800) 221-9723 or (818) 882-8611
FAX (818) 882-7028

E-MAIL order@rpiparts.com

WEBSITE www.rpiparts.com

All orders received before 2:00 PM (Pacific Time), Monday through Friday are shipped the same day so you get the parts you need fast! Our regular business hours are 8:00 AM to 4:30 PM (Pacific Time).

EXCELLENT CUSTOMER SERVICE

You can be sure that your order will be handled professionally and accurately by our Customer Service Department.

FREE TECHNICAL ASSISTANCE

Should you need technical assistance, just ask for the Technical Service Department. One of our engineers can help you find a repair solution.

CALL (800) 221-9723, ext. 135

E-MAIL techsupport@rpiparts.com

FAST DELIVERY

Orders received by 2:00 PM (Pacific Time) will be shipped the same day ... and you choose which freight method is best for you – Overnight, Second-Day, Three-Day or Ground Service Delivery. It's your choice.

CONVENIENT SHIPMENTS

Split shipments or drop shipments may be arranged at no extra charge.

QUANTITY PRICE BREAKS

We offer quantity price breaks on most parts. All prices shown in the RPI price lists are net prices and subject to change without notice.

100% SATISFACTION GUARANTEED

Our parts must meet with your complete satisfaction. All RPI parts are manufactured

to meet or exceed the original equipment manufacturer specifications and warranty requirements. Should any RPI part not meet with your complete satisfaction, please contact our Technical Service Department, toll-free (800) 221-9723 ext. 135 or (818) 882-8611 ext. 135 as soon as possible to obtain a Returned Merchandise Authorization (RMA) Number prior to returning any part. We will gladly arrange an exchange or credit. (No parts may be returned without an RMA Number and returned parts may be subject to a 15% restocking fee.)

EASY-TO-USE CATALOG

The RPI catalog is more than just a listing of parts. It's a work tool. Keep it handy and refer to it often. It's your best source for replacement parts.

The catalog is divided into sections based on type of equipment so that you can go right to the parts you need. Within each section, parts are categorized based on the OEM and model that they fit. Plus, at the beginning of each section is an Index that lists all of the OEMs, models, and the page numbers where you can locate the parts to fit them. Illustrations and detailed descriptions are provided for each part to simplify identification. What's more, all of the O-ring and cross section illustrations are to actual size.

Also included are several at-a-glance Reference Guides. They are helpful when you know what you need, but you don't have all of the information for a particular part.

And there's a section at the end of the catalog for you to keep all of the RPI newsletters, "The Alternate Source"®.

NEW PRODUCT UPDATES

We continuously add new parts, so please visit the RPI website www.rpiparts.com or watch for the RPI newsletter, "The Alternate Source"®, and our "New Parts" flyers that we distribute throughout the year so that you can keep your catalog up to date.

VISIT THE RPI WEBSITE

Searching for a part has never been easier than on RPI's website. Quickly search by OEM, Model, Equipment Type, RPI Part Number, OEM Part Number, or Part Name. You will also find our "Technical Resource Center" where you can download Installation Instructions, Troubleshooting Guides, Tech Help Videos and more. Visit the RPI website:

www.rpiparts.com

OUR MAILING ADDRESS

Please address all correspondence to:

Replacement Parts Industries, Inc.

P.O. Box 940250

Simi Valley, California 93094

ABOUT OUR TERMS OF SALE

Our minimum order is \$20.00 and our terms are net 30 days for Open Accounts. American Express, VISA and MasterCard are accepted. Shipping and handling is prepaid and added to the invoice. Past due invoices are subject to a late charge of 1-1/2% per month. Shipments are F.O.B. RPI Plant, Simi Valley, California. Returned checks are subject to a \$20.00 charge. No allowances for shortages, overcharge or damage unless reported within 10 days from the invoice date. For our **international customers (except Canada)**, we request payment in full in U.S. \$ prior to shipping any order, and payment may be made by American Express, VISA or MasterCard, or by a check drawn on a U.S. bank, international money order or bank wire transfer which is subject to a bank fee.

 **WARNING:** Some parts listed in this catalog contain chemicals known to the State of California to cause cancer and/or birth defects or other reproductive harm. For more information, please visit www.P65Warnings.ca.gov, and go to the RPI website for specific information on these parts.

PLEASE READ CAREFULLY

Seller makes no warranty of any kind, express or implied, except that the products sold from this catalog shall be of merchantable quality, and buyer assumes all risk and liability resulting from the use of these products, whether individually or in combination with other products. All parts shown in this catalog are manufactured or supplied by Replacement Parts Industries, Inc. to be used as replacement parts for original equipment. Replacement Parts Industries, Inc. neither manufactures nor distributes any machines used by healthcare professions. Our liability is limited to the cost of the defective RPI part.

All rights reserved. No part of this catalog may be reproduced or utilized in any form or by any means without permission in writing from the Publisher. Inquiries should be addressed to: Replacement Parts Industries, Inc., Marketing Department, P.O. Box 940250, Simi Valley, California 93094. This catalog supersedes all previous editions. RPI © 2018.

SECTION 1 - Analyzers

Coulter.....	100
Instrumentation Laboratories.....	100

SECTION 2 - Aspirators & Pumps

Cross Reference.....	100
Gomco.....	200
Sklar.....	300

SECTION 3 - Centrifuges

Cross Reference.....	100
Baxter.....	200
Beckman.....	300
Bio-Dynamics.....	400
Clay Adams.....	500
Drucker.....	600
Eppendorf.....	700
Hamilton Bell.....	800
IEC (International Equipment/Damon).....	900
Sorvall.....	1000

SECTION 4 - Dental Equipment

Cross Reference.....	100
----------------------	-----

Dental Chairs

A-dec.....	200
Dentalez.....	300
Pelton & Crane.....	304
Ritter.....	302

Dental Compressors

Air Techniques.....	404
Apollo by Midmark.....	402
DCI (MDT McKesson).....	404 & 405
Dentalez.....	402, 403 & 405
Jun-Air.....	402, 403 & 405
Matrix by Midmark.....	402, 404 & 405
MDT McKesson (DCI).....	404 & 405
Pelton & Crane.....	400
Tech West/Turbine Industries.....	403, 404 & 405

Dental Delivery Systems/Units

A-dec.....	500
Pelton & Crane.....	550

Dental Film Processors

Air Techniques.....	600
Dent-X (Phillips).....	700
Litton.....	800
Gendex.....	850

Dental Laboratory Equipment

Ney.....	900
Ray Foster.....	902
Wells.....	902
Whip Mix.....	903

Dental Lamps & Bulbs.....	1000
---------------------------	------

SECTION 4 - Dental Equipment (continued)

Dental Lights

A-dec.....	1100
Belmont & Healthco.....	1202
Castle.....	1201
Henry Schein.....	1200
Knight.....	1200
Marus.....	1200
Pelton & Crane.....	1300
Ritter.....	1200

Dental Motors

EMESCO.....	1400
Ritter.....	1400
Wells.....	1400

Dental Equipment Tools

Tools.....	1500
------------	------

Dental X-Ray Units

Gendex.....	1600
-------------	------

SECTION 5 - ECG, NIBP, Cables, etc.

Cross Reference.....	100
Burdick.....	200
GE/Critikon.....	300
Patiet Cables and Leadwires.....	400

SECTION 6 - General Shop Aids

Table of Contents.....	100
Assessories & Supplies.....	200
Electrical.....	300
Hardware.....	400
O-Rings.....	500
Plumbing.....	600
Tools.....	700

SECTION 7 - Infant Warmers & Incubators

Cross Reference.....	100
----------------------	-----

Infant Incubators

Air Shields • Hill-Rom • Drager.....	200
Ohio Medical • Ohmeda • GE.....	206

Infant Warmers

Air Shields • Hill-Rom • Drager.....	208
Ohio Medical • Ohmeda • GE.....	214

Phototherapy Lights

Air Shields • Hill-Rom • Drager.....	216
--------------------------------------	-----

SECTION 8 - Lamps & Bulbs

Cross Reference.....	100
Lamps & Bulbs.....	200

SECTION 9 - Orthopedics & Physical Therapy

Cross Reference.....	100
Chattanooga.....	200
Logan.....	200
American Orthopaedic.....	300
Burnett.....	300
Stryker.....	300

SECTION 10 - Sterilizers

(Bulk/Washers, Endoscope Washers & Table Top)

Cross Reference.....	100
----------------------	-----

Bulk Sterilizers & Sterilizer Washers

American Sterilizer (AMSCO).....	200
Castle (Getinge/Castle).....	300
Water-Mizer™.....	400

Endoscope Washers

Steris.....	500
-------------	-----

Table Top Sterilizers

American Sterilizer.....	600
Barnstead.....	700
MDT (Harvey).....	800
MDT • Ritter • Castle.....	900
Midmark • Ritter.....	1000
National Appliance.....	1100
Pelton & Crane.....	1200
Prestige • Kavo.....	1300
Ritter • Castle.....	1400
SciCan.....	1500
Spectroline & S.S. White.....	1600
Tuttner.....	1700
Vernitron.....	1800

SECTION 11 - Tables & Chairs (Exam/Surgical)

Cross Reference.....	100
Hamilton.....	200
Midmark • Ritter.....	300
Ritter.....	400

SECTION 12 -

Tech Notes & Trouble-Shooting Guides

Installation instructions, Trouble-Shooting Guides, and other information regarding RPI parts are available to view or print via the RPI website. For easy access, store copies of these documents in Section 12 of the catalog.

www.rpiparts.com

SECTION 13 - Reference Guides

Carbon Brushes.....	100
Time Switches/Timers.....	101

For standard, specialty, and one-of-a-kind tools, see General Shop Aids, Section 6.

Equipment Guide Chart

EQUIPMENT GUIDE CHART

	Section 1 Analyzers	Section 2 Aspirator & Pumps	Section 3 Centrifuges	Section 4 Dental Chairs	Section 4 Dental Compressors	Section 4 Dental Delivery Sys & Units	Section 4 Dental Film Processors	Section 4 Dental Lab Equipment	Section 4 Dental Lights	Section 4 Dental Motors	Section 4 Dental X-Ray Units	Section 5 ECC/WIP/Cables etc.	Section 7 Inflat Warmers & Incubators	Section 8 Orthopedics & Phys Therapy	Section 9 Endoscope Washers	Section 10 Sterilizer (Bulk & Table Top)	Section 11 Tables & Chairs (Exam/ Surg)
A-dec, Inc.																	
Air Shields+Hill-Rom+Drager																	
Air Techniques Inc.																	
Allied Healthcare Products Inc. (See Gomco)																	
Allied Photo Products Co., Inc. (See Litton)																	
American Sterilizer Co. (AMSCO)																	
AMSCO (See American Sterilizer Co.)																	
Apollo by Midmark																	
Barnstead																	
Baxter																	
Beckman Instruments																	
Becton Dickinson (See Clay Adams)																	
Belmont/Healthco																	
Bio-Dynamics Inc.																	
Burdick																	
Castle Co. (Gentinge/Castle Co.)																	
Chattanooga Corp.																	
Clay Adams (Becton Dickinson Primary Care Diagnostic)																	
Coulter																	
Critikon (See GE/Critikon)																	
Damon (See IEC/International Equipment Co.)																	
DCI (MDT McKesson)																	
DentalEZ Inc.																	
Dent-X (Philips Dental Systems)																	
Drager (See Air Shields+Hill-Rom+Drager)																	
Drucker																	
DuPont Company (See Sorvall)																	
Emesco (Teledyne Hanau)																	
Eppendorf																	
GE/Critikon																	
Gendex																	
Gentinge/Castle Co. (See Castle)																	
Gomco (Allied Healthcare Products Inc.)																	
Hamilton Bell																	
Hamilton Industries Inc.																	
Healthco/Apollo																	
Healthco/Belmont																	
Henry-Schein/Marus																	
Hewlett Packard Co.																	
Hill-Rom (See Air Shields+Hill-Rom+Drager)																	
Hope (See Litton)																	
IEC (International Equipment Co. and Damon)																	
International Equipment Co. (See IEC)																	
Jagco (See Veritron)																	
Jun-Air																	
Knight by Midmark																	
Litton (Allied Photo Products Co., Inc., Hope and Xonics)																	
Logan Inc.																	
Marus/Henry-Schein																	
Matrix by Midmark																	
MDT (Harvey)/Barnstead																	
MDT McKesson (DCI)																	
MDT+Ritter+Castle																	
Midmark+Ritter																	
National Appliance (NAPCO and Precision Scientific Inc.)																	
Ney Dental (NDI)																	
Ohio Medical+Ohmeda+GE																	
Pelton & Crane Co.																	
Philips Dental Systems (See Dent-X)																	
Precision Scientific Inc. (National Appliance)																	
Ray Foster																	
Ritter																	
Ritter+Castle																	
SciCan																	
Sklar Instrument Co.																	
Sorvall Products																	
Spectrolite (Spectronics Corp.)																	
Spectronics Corp. (See Spectrolite)																	
S.S. White																	
Steris																	
Stryker Instruments																	
Tech West/Turbine Industries																	
Teledyne Hanau (See Emesco)																	
Turbine Industries/Tech West																	
Tuttnauer																	
Veritron Medical Products																	
Xonics (See Litton)																	
Wells																	
Whipmix Corp																	

Effective December 1, 2001, RPI will no longer carry a complete line of parts to fit Coulter and Instrumentation Laboratories equipment. However, due to popular demand, we will carry the parts listed below.

COULTER

RPI Part #COV009
 OEM Part #6214108
SMALL CHECK VALVE (DIODE)
 Fits: Fluidic and Pneumatic Lines
 Models: All models



RPI Part #COV010
 OEM Part #6214107
MEDIUM CHECK VALVE (DIODE)
 Fits: Fluidic and Pneumatic Lines
 Models: All models



RPI Part #COV011
 OEM Part #6214106
LARGE CHECK VALVE (DIODE)
 Fits: Fluidic and Pneumatic Lines
 Models: All models



INSTRUMENTATION LABORATORIES

RPI Part #ILS014
 OEM Part # N/A
HEX SPACER
 Fits: Solenoid Valve in Gas Plumbing
 Models: 143, 243, 343, 443, 643 & 943

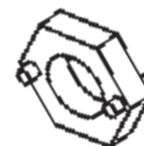

RPI Part #	OEM Part #	Description	Section 2 Page #
------------	------------	-------------	------------------

GOMCO

DIAPHRAGM PUMPS

Models: 280, 2801, 3020, 3040 & 6030

● CAS063	01-90-2304	ON/OFF SWITCH	200
----------	------------	---------------	-----

Model 300 Series

GOA019	01-90-2000	TUBING KIT (DISPOSABLE)	200
● GOC044	01-90-3695	DISPOSABLE COLLECTION CANISTER (1100ML)	200
● GOC045	01-90-3712	DISPOSABLE COLLECTION CANISTER (2100ML)	200
GOC020	01-90-2674	600ml RUBBER BOTTLE CAP	200
GOF024	01-90-3928	BACTERIA FILTER	200
GOF025	01-90-3100	BACTERIA FILTER	200
● GOG046	01-90-3059	VACUUM GAUGE (300 SERIES PORT)	200
● GOK043	01-90-2295	DIAPHRAGM PARTS KIT (300 SERIES)	200
GOS001	01-90-0550	NO. 8 STOPPER	200

All Diaphragm Pump Models

GOA019	01-90-2000	TUBING KIT (DISPOSABLE)	200
GOC020	01-90-2674	600ml RUBBER BOTTLE CAP	200
● GOC044	01-90-3695	DISPOSABLE COLLECTION CANISTER (1100ML)	200
● GOC045	01-90-3712	DISPOSABLE COLLECTION CANISTER (2100ML)	200
GOF024	01-90-3928	BACTERIA FILTER	200
GOF025	01-90-3100	BACTERIA FILTER	200
GOS001	01-90-0550	NO. 8 STOPPER	200

ROTARY PUMPS

Models: 400, 402, 4010, 4030, 4040, 4050 & 4070

● CAS063	01-90-2304	ON/OFF SWITCH	200
----------	------------	---------------	-----

All Models with Rotary Pumps with 5/8" Rotor and 1/20 hp Motor

GOA019	01-90-2000	TUBING KIT (DISPOSABLE)	200
GOC020	01-90-2674	600ml RUBBER BOTTLE CAP	200
● GOC044	01-90-3695	DISPOSABLE COLLECTION CANISTER (1100ML)	200
● GOC045	01-90-3712	DISPOSABLE COLLECTION CANISTER (2100ML)	200
GOF024	01-90-3928	BACTERIA FILTER	200
GOF025	01-90-3100	BACTERIA FILTER	200
GOL022	01-90-3106	ROTARY PUMP OIL	201
GOS001	01-90-0550	NO. 8 STOPPER	200
● GOS036	01-90-2322	5/8" ROTOR SLIDE	201
● GOW037	01-90-3067	5/8" OIL WICK	201

All Models with Rotary Pumps with 3/4" Rotor and 1/6 hp Motor

GOA019	01-90-2000	TUBING KIT (DISPOSABLE)	200
GOC020	01-90-2674	600ml RUBBER BOTTLE CAP	200
● GOC044	01-90-3695	DISPOSABLE COLLECTION CANISTER (1100ML)	200
● GOC045	01-90-3712	DISPOSABLE COLLECTION CANISTER (2100ML)	200
GOF024	01-90-3928	BACTERIA FILTER	200
GOF025	01-90-3100	BACTERIA FILTER	200
GOK017	01-90-2416	3/4" ROTOR SLIDE ASSEMBLY KIT	201
GOL022	01-90-3106	ROTARY PUMP OIL	201
GOR028	01-90-2417	3/4" ROTOR	201
GOS001	01-90-0550	NO. 8 STOPPER	200
GOS029	01-90-2418	3/4" ROTOR SLIDE	201
● GOW035	01-90-2875	3/4" OIL WICK	201

All Models with Rotary Pumps with 1" Rotor and 1/4 or 1/6 hp Motor

GOA019	01-90-2000	TUBING KIT (DISPOSABLE)	200
GOC020	01-90-2674	600ml RUBBER BOTTLE CAP	200
● GOC044	01-90-3695	DISPOSABLE COLLECTION CANISTER (1100ML)	200
● GOC045	01-90-3712	DISPOSABLE COLLECTION CANISTER (2100ML)	200
GOF024	01-90-3928	BACTERIA FILTER	200
GOF025	01-90-3100	BACTERIA FILTER	200
GOK017	01-90-2416	3/4" ROTOR SLIDE ASSEMBLY KIT	201
GOL022	01-90-3106	ROTARY PUMP OIL	201
GOR028	01-90-2417	3/4" ROTOR	201
GOS001	01-90-0550	NO. 8 STOPPER	200
● GOS038	01-90-0853	1" ROTOR SLIDE	201
● GOW039	01-90-2876	1" OIL WICK	201

All Models with Rotary Pumps and Overflow Valve

GOA019	01-90-2000	TUBING KIT (DISPOSABLE)	200
GOC020	01-90-2674	600ml RUBBER BOTTLE CAP	200
● GOC044	01-90-3695	DISPOSABLE COLLECTION CANISTER (1100ML)	200
● GOC045	01-90-3712	DISPOSABLE COLLECTION CANISTER (2100ML)	200
GOD018	01-90-3108	FILTER DISC	201

● NEW PART

RPI Part #	OEM Part #	Description	Section 2 Page #
------------	------------	-------------	------------------

GOMCO (continued)

All Models with Rotary Pumps and Overflow Valve (continued)

GOF002	01-90-3107	FELT FILTER DISC	201
GOF024	01-90-3928	BACTERIA FILTER	200
GOF025	01-90-3100	BACTERIA FILTER	200
GOG014	01-90-2330	VALVE GASKET	201
GOK027	01-90-2291	ROTARY UNIT PARTS KIT	201
GOS001	01-90-0550	NO. 8 STOPPER	200
GOS007	01-90-2902	VALVE SPRING	201

All Models with Rotary Pumps requiring 1/8 MPT with Center Back Mount

GOA019	01-90-2000	TUBING KIT (DISPOSABLE)	200
GOC020	01-90-2674	600ml RUBBER BOTTLE CAP	200
● GOC044	01-90-3695	DISPOSABLE COLLECTION CANISTER (1100ML)	200
● GOC045	01-90-3712	DISPOSABLE COLLECTION CANISTER (2100ML)	200
GOF024	01-90-3928	BACTERIA FILTER	200
GOF025	01-90-3100	BACTERIA FILTER	200
GOG006	01-90-2338	VACUUM GAUGE	201
GOL022	01-90-3106	ROTARY PUMP OIL	201
GOS001	01-90-0550	NO. 8 STOPPER	200

All Models with Rotary Pumps using 600ml Bottle Top

GOA019	01-90-2000	TUBING KIT (DISPOSABLE)	200
GOC020	01-90-2674	600ml RUBBER BOTTLE CAP	200
● GOC044	01-90-3695	DISPOSABLE COLLECTION CANISTER (1100ML)	200
● GOC045	01-90-3712	DISPOSABLE COLLECTION CANISTER (2100ML)	200
GOF024	01-90-3928	BACTERIA FILTER	200
GOF025	01-90-3100	BACTERIA FILTER	200
GOK027	01-90-2291	ROTARY UNIT PARTS KIT	201
GOL022	01-90-3106	ROTARY PUMP OIL	201
GOS001	01-90-0550	NO. 8 STOPPER	200

All Models with Rotary Pumps with Trap Bottle

GOA019	01-90-2000	TUBING KIT (DISPOSABLE)	200
GOC020	01-90-2674	600ml RUBBER BOTTLE CAP	200
● GOC044	01-90-3695	DISPOSABLE COLLECTION CANISTER (1100ML)	200
● GOC045	01-90-3712	DISPOSABLE COLLECTION CANISTER (2100ML)	200
GOF024	01-90-3928	BACTERIA FILTER	200
GOF025	01-90-3100	BACTERIA FILTER	200
GOL022	01-90-3106	ROTARY PUMP OIL	201
GOS001	01-90-0550	NO. 8 STOPPER	200

All Models with Rotary Pumps incorporating Bacteria Filter as Standard Equipment

GOA019	01-90-2000	TUBING KIT (DISPOSABLE)	200
GOC020	01-90-2674	600ml RUBBER BOTTLE CAP	200
● GOC044	01-90-3695	DISPOSABLE COLLECTION CANISTER (1100ML)	200
● GOC045	01-90-3712	DISPOSABLE COLLECTION CANISTER (2100ML)	200
GOF024	01-90-3928	BACTERIA FILTER	200
GOF025	01-90-3100	BACTERIA FILTER	200
GOL022	01-90-3106	ROTARY PUMP OIL	201
GOS001	01-90-0550	NO. 8 STOPPER	200

THERMOTIC PUMPS

Model 270

GOA019	01-90-2000	TUBING KIT (DISPOSABLE)	200
GOC020	01-90-2674	600ml RUBBER BOTTLE CAP	200
● GOC044	01-90-3695	DISPOSABLE COLLECTION CANISTER (1100ML)	200
● GOC045	01-90-3712	DISPOSABLE COLLECTION CANISTER (2100ML)	200
GOF024	01-90-3928	BACTERIA FILTER	200
GOF025	01-90-3100	BACTERIA FILTER	200
GOL032	01-90-2310	PUMP CYCLE LIGHT	202
GOS001	01-90-0550	NO. 8 STOPPER	200

Model 765A

GOA019	01-90-2000	TUBING KIT (DISPOSABLE)	200
● GOB016**	01-90-3045	PC BOARD	202
GOC020	01-90-2674	600ml RUBBER BOTTLE CAP	200
● GOC044	01-90-3695	DISPOSABLE COLLECTION CANISTER (1100ML)	200
● GOC045	01-90-3712	DISPOSABLE COLLECTION CANISTER (2100ML)	200
GOF024	01-90-3928	BACTERIA FILTER	200
GOF025	01-90-3100	BACTERIA FILTER	200
GOG014	01-90-2330	VALVE GASKET	201
GOH004*	01-90-2713	HEATER 115 VAC 149 Ω (OLD STYLE)	202
GOH005**	01-90-2713	HEATER 115 VAC 160 Ω	202
GOL026	01-90-3570	PILOT LAMP	202

(continued)

Aspirators & Pumps

RPI Part #	OEM Part #	Description	Section 2 Page #
------------	------------	-------------	------------------

GOMCO

Model 765A (continued)

GOS001	01-90-0550	NO. 8 STOPPER	200
GOS010*	01-90-3050	MICRO-SWITCH	202
GOS030	(None)	ON/OFF SWITCH	202
GOS031	(None)	HI/LOW SWITCH	202
GOV011	01-90-3433	SUCTION VALVE (INLET)	202
GOV012	01-90-3432	PRESSURE VALVE (OUTLET)	202
GOV013	01-90-8140	AEROVENT RUBBER VALVE	202

* Indicates unit with electro-mechanical control
** Indicates unit with electronic control

Model 764

GOA019	01-90-2000	TUBING KIT (DISPOSABLE)	200
GOB016**	01-90-3045	PC BOARD	202
GOC020	01-90-2674	600ml RUBBER BOTTLE CAP	200
● GOC044	01-90-3695	DISPOSABLE COLLECTION CANISTER (1100ML)	200
● GOC045	01-90-3712	DISPOSABLE COLLECTION CANISTER (2100ML)	200
GOF024	01-90-3928	BACTERIA FILTER	200
GOF025	01-90-3100	BACTERIA FILTER	200
GOG014	01-90-2330	VALVE GASKET	201
GOH004*	01-90-2713	HEATER 115 VAC 149 Ω (OLD STYLE)	202
GOH005**	01-90-2713	HEATER 115 VAC 160 Ω	202
GOL026	01-90-3570	PILOT LAMP	202
GOS001	01-90-0550	NO. 8 STOPPER	200
GOS010*	01-90-3050	MICRO-SWITCH	202
GOS030	(None)	ON/OFF SWITCH	202
GOS031	(None)	HI/LOW SWITCH	202
GOV011	01-90-3433	SUCTION VALVE (INLET)	202
GOV012	01-90-3432	PRESSURE VALVE (OUTLET)	202
GOV013	01-90-8140	AEROVENT RUBBER VALVE	202

* Indicates unit with electro-mechanical control
** Indicates unit with electronic control

Model 965A

GOA019	01-90-2000	TUBING KIT (DISPOSABLE)	200
GOC020	01-90-2674	600ml RUBBER BOTTLE CAP	200
● GOC044	01-90-3695	DISPOSABLE COLLECTION CANISTER (1100ML)	200
● GOC045	01-90-3712	DISPOSABLE COLLECTION CANISTER (2100ML)	200
GOF024	01-90-3928	BACTERIA FILTER	200
GOF025	01-90-3100	BACTERIA FILTER	200
GOG014	01-90-2330	VALVE GASKET	201
GOH004*	01-90-2713	HEATER 115 VAC 149 Ω (OLD STYLE)	202
GOH005**	01-90-2713	HEATER 115 VAC 160 Ω	202
GOS001	01-90-0550	NO. 8 STOPPER	200
GOS010*	01-90-3050	MICRO-SWITCH	202
GOV011	01-90-3433	SUCTION VALVE (INLET)	202
GOV012	01-90-3432	PRESSURE VALVE (OUTLET)	202
GOV013	01-90-8140	AEROVENT RUBBER VALVE	202

* Indicates unit with electro-mechanical control
** Indicates unit with electronic control

Model 6000 (600)

● CAS063	01-90-2304	ON/OFF SWITCH	200
GOA019	01-90-2000	TUBING KIT (DISPOSABLE)	200
GOB023	01-90-2311	PC BOARD	202
GOC020	01-90-2674	600ml RUBBER BOTTLE CAP	200
● GOC044	01-90-3695	DISPOSABLE COLLECTION CANISTER (1100ML)	200
● GOC045	01-90-3712	DISPOSABLE COLLECTION CANISTER (2100ML)	200
GOF024	01-90-3928	BACTERIA FILTER	200
GOF025	01-90-3100	BACTERIA FILTER	200
GOH005**	01-90-2713	HEATER 115 VAC 160 Ω	202
GOL032	01-90-2310	PUMP CYCLE LIGHT	202
GOS001	01-90-0550	NO. 8 STOPPER	200
GOV011	01-90-3433	SUCTION VALVE (INLET)	202
GOV012	01-90-3432	PRESSURE VALVE (OUTLET)	202

** Indicates unit with electronic control

Model 6010 (601)

● CAS063	01-90-2304	ON/OFF SWITCH	200
GOA019	01-90-2000	TUBING KIT (DISPOSABLE)	200
GOB023	01-90-2311	PC BOARD	202
GOC020	01-90-2674	600ml RUBBER BOTTLE CAP	200
● GOC044	01-90-3695	DISPOSABLE COLLECTION CANISTER (1100ML)	200
● GOC045	01-90-3712	DISPOSABLE COLLECTION CANISTER (2100ML)	200
GOF024	01-90-3928	BACTERIA FILTER	200
GOF025	01-90-3100	BACTERIA FILTER	200
GOH005**	01-90-2713	HEATER 115 VAC 160 Ω	202
GOL032	01-90-2310	PUMP CYCLE LIGHT	202
GOS001	01-90-0550	NO. 8 STOPPER	200
GOV011	01-90-3433	SUCTION VALVE (INLET)	202
GOV012	01-90-3432	PRESSURE VALVE (OUTLET)	202

** Indicates unit with electronic control

RPI Part #	OEM Part #	Description	Section 2 Page #
------------	------------	-------------	------------------

GOMCO (continued)

Model 6020

● CAS063	01-90-2304	ON/OFF SWITCH	200
GOA019	01-90-2000	TUBING KIT (DISPOSABLE)	200
GOC020	01-90-2674	600ml RUBBER BOTTLE CAP	200
● GOC044	01-90-3695	DISPOSABLE COLLECTION CANISTER (1100ML)	200
● GOC045	01-90-3712	DISPOSABLE COLLECTION CANISTER (2100ML)	200
GOF024	01-90-3928	BACTERIA FILTER	200
GOF025	01-90-3100	BACTERIA FILTER	200
GOL032	01-90-2310	PUMP CYCLE LIGHT	202
GOS001	01-90-0550	NO. 8 STOPPER	200

Model 6650

GOA019	01-90-2000	TUBING KIT (DISPOSABLE)	200
GOC020	01-90-2674	600ml RUBBER BOTTLE CAP	200
● GOC044	01-90-3695	DISPOSABLE COLLECTION CANISTER (1100ML)	200
● GOC045	01-90-3712	DISPOSABLE COLLECTION CANISTER (2100ML)	200
GOF024	01-90-3928	BACTERIA FILTER	200
GOF025	01-90-3100	BACTERIA FILTER	200
GOL032	01-90-2310	PUMP CYCLE LIGHT	202
GOS001	01-90-0550	NO. 8 STOPPER	200
GOV011	01-90-3433	SUCTION VALVE (INLET)	202
GOV012	01-90-3432	PRESSURE VALVE (OUTLET)	202

All Electro-Mechanical Thermotic Pumps with Bimetallic Arm Prior to PC Board

GOA019	01-90-2000	TUBING KIT (DISPOSABLE)	200
GOC020	01-90-2674	600ml RUBBER BOTTLE CAP	200
● GOC044	01-90-3695	DISPOSABLE COLLECTION CANISTER (1100ML)	200
● GOC045	01-90-3712	DISPOSABLE COLLECTION CANISTER (2100ML)	200
GOF024	01-90-3928	BACTERIA FILTER	200
GOF025	01-90-3100	BACTERIA FILTER	200
GOH004*	01-90-2713	HEATER 115 VAC 149 Ω	202
GOS001	01-90-0550	NO. 8 STOPPER	200
GOS010	01-90-3050	MICRO-SWITCH	202

* Indicates unit with electro-mechanical control

All Models with Aerovent Valve

GOA019	01-90-2000	TUBING KIT (DISPOSABLE)	200
GOC020	01-90-2674	600ml RUBBER BOTTLE CAP	200
● GOC044	01-90-3695	DISPOSABLE COLLECTION CANISTER (1100ML)	200
● GOC045	01-90-3712	DISPOSABLE COLLECTION CANISTER (2100ML)	200
GOF024	01-90-3928	BACTERIA FILTER	200
GOF025	01-90-3100	BACTERIA FILTER	200
GOS001	01-90-0550	NO. 8 STOPPER	200
GOV013	01-90-8140	AEROVENT RUBBER VALVE	202

SKLAR

Models: All J.R. Tompkins (100-65)

SKA009	02-6521	COMPRESSOR OUTLET ADAPTOR	300
SKC011	02-4513	FILTER CAP	300
SKF005	04-5001	FELT FILTER	300
SKF008	(None)	RUBBER FOOT	300
SKF012	02-4007	SUCTION AND PRESSURE FILTER ASSEMBLY	300
SKG004	02-4506	FILTER CAP GASKET	300
SKG010	02-5101	VACUUM GAUGE	300
SKN003	02-4512	OPEN FILTER NUT	300
SKR007	2-6519	ROTOR BODY	300
SKS001	02-9031	TOGGLE SWITCH	300
SKS006	02-6502	ROTOR SLIDE	300
SKS013	02-6506	ROTOR HOUSING PLATE SCREW	300
SKS014	02-6505	ROTOR HOUSING SCREW	300
SKS021	04-3501	NEEDLE VALVE REGULATOR SPRING	300
SKW015	02-4510	FILTER WINDOW	300

RPI PART #GOC044
OEM PART #01-90-3695

DISPOSABLE COLLECTION CANISTER (1100 ml)

- 1100 ml
- Clear plastic graduated canister with blue lid
- Hydro-filter shut-off
- Large pour spout

Fits: Stand or mounting bracket ring
Diaphragm Pump Models: 300 Series

Rotary Pump Models: Rotary pumps with 5/8" rotor and 1/20 HP motor; with 3/4" rotor and 1/6 HP motor; and, with 1" rotor and 1/4 or 1/6 HP motor

Thermotic Pump Models: 6000, 6020 and 6650



RPI Part #GOF024
OEM Part #01-90-3928

BACTERIA FILTER

- 3 per package
- 0.3 micron
- 1/4" Barb x 1/4" hose barb
- Disk size 2.100"

Models:

All models incorporating bacteria filter as standard equipment



RPI PART #GOC045
OEM PART #01-90-3712

DISPOSABLE COLLECTION CANISTER (2100 ml)

- 2100 ml
- Clear plastic graduated canister with blue lid
- Hydro-filter shut-off
- Large pour spout; Tandem ports

Fits: Stand or mounting bracket ring

Diaphragm Pump Models: 300 Series and all diaphragm pump models

Rotary Pump Models: Rotary pumps with 5/8" rotor and 1/20 HP motor; with 3/4" rotor and 1/6 HP motor; and, with 1" rotor and 1/4 or 1/6 HP motor

Thermotic Pump Models: 6000, 6020 and 6650

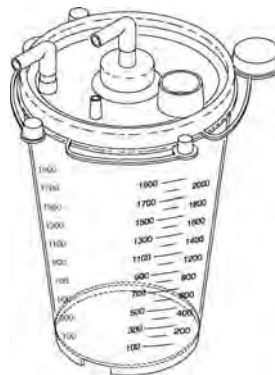

RPI Part #GOF025
OEM Part #01-90-3100

BACTERIA FILTER

- 3 per package
- 0.3 micron
- 1/4" Barb x 1/8" MPT
- Disk size 2.100"

Models: All models incorporating bacteria filter as standard equipment



RPI Part #CAS063
OEM Part #01-90-2304

ON/OFF SWITCH

- SPDT
- 15 A @ 125 VAC; 10 A @ 250 VAC;
- 1/2 HP @ 250 VAC

Fits: Front panel of base

Diaphragm Pump Models: 280, 2801, 3020, 3040 & 6030

Rotary Pump Models: 400, 402, 4010, 4030, 4040, 4050 & 4070

Thermotic Pump Models: 6000, 6010 & 6020
Motor: 6050

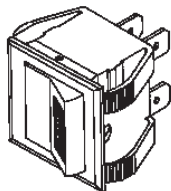

New RPI Part #GOA019
Old RPI Part #GOK019
OEM Part #01-90-2000

TUBING KIT (DISPOSABLE)

- Includes (1) each of 15" and 6' long tubing

Models: All models

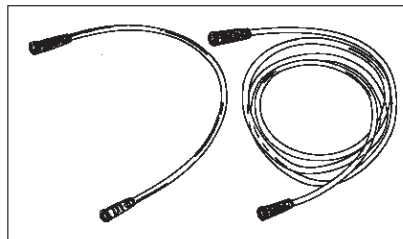

RPI Part #GOS001
OEM Part #01-90-0550

NO. 8 STOPPER

Fits: Bottle Top
Models: All models with trap bottle



RPI Part #GOC020
OEM Part #01-90-2674

600ml RUBBER BOTTLE CAP

Fits: All models using 600ml bottle top

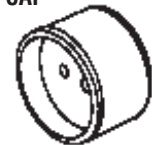

Also available to fit Diaphragm Pumps

- Disp. Collection Canisters
- Bacteria Filters
- Rubber Bottle Cap
- No. 8 Stopper
- On/Off Switch

See parts above.

RPI PART #GOK043
OEM PART #01-90-2295

DIAPHRAGM PARTS KIT (300 SERIES)

Fits: Pump head
Models: 300 Series

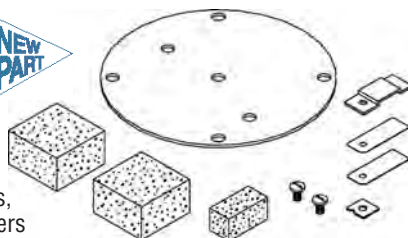

Kit includes: Head gasket, (2) valves, (2) valve retainers, (2) valve screws, and (3) filters

RPI PART #GOG046
OEM PART #01-90-3059

VACUUM GAUGE (300 SERIES PORT)

Fits: Muffler bar
Models: 300 Series

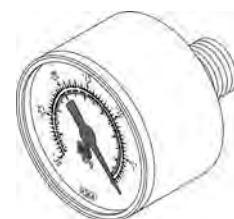

Also available to fit Rotary Pumps

- Disp. Collection Canisters
 - Bacteria Filters
 - Rubber Bottle Cap
 - No. 8 Stopper
 - On/Off Switch
- See Section 2, page 200.

RPI Part #GOG006
OEM Part #01-90-2338

VACUUM GAUGE
• 1.500" diameter dial
• 0-30" Hg. (0-76 mm Hg.)
• Black ABS case
Fits: Muffler bar
Models: All models requiring 1/8" MPT with center back mount

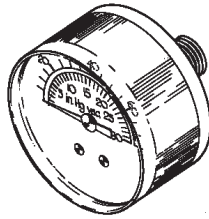

RPI Part #GOG014
OEM Part #01-90-2330

VALVE GASKET
Fits: Overflow Valve Cover (back)
Models: All models with overflow valve



RPI Part #GOS007
OEM Part #01-90-2902

VALVE SPRING
Fits: Overflow Valve Back
Models: All models with overflow valve



RPI PART #GOW037
OEM PART #01-90-3067

5/8" OIL WICK
• 3 per package; White F-1 felt
Models: Fits rotary pumps with 5/8" rotor and 1/20 HP motor



RPI PART #GOS036
OEM PART #01-90-2322

5/8" ROTOR SLIDE
• 3 per package; brass
Models: Fits rotary pumps with 5/8" rotor and 1/20 HP motor

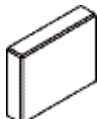

RPI Part #GOK027
OEM Part #01-90-2291

ROTARY UNIT PARTS KIT
• Includes 15" long tubing, 6' long tubing, rotary pump oil (4 fl. oz.), 600 ml rubber bottle cap, (4) felt filter disc, and (4) filter disc
Models: All rotary pumps with overflow valve and 600ml bottle

All parts in Kit also sold separately

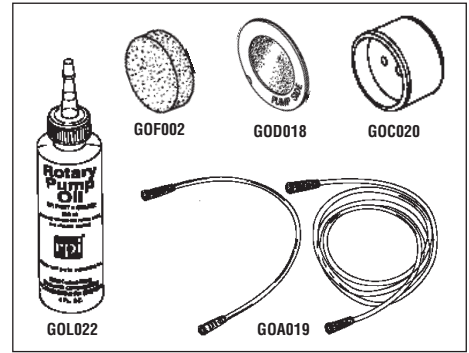

RPI Part #GOD018
OEM Part #01-90-3108

FILTER DISC
• 12 per package
• Replaces old style chamois disc
• When replacing this part, it is also a good time to replace the Felt Filter Disc (RPI Part# GOF002)



Fits: Between Valve Spring and Overflow Valve Cover Gasket inside Overflow Valve
Models: All models with overflow valve

RPI Part #GOF002
OEM Part #01-90-3107

FELT FILTER DISC
• 12 per package
Fits: Overflow Valve Cover (front)
Models: All models with overflow valve

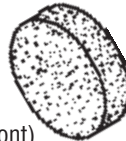

RPI Part #GOL022
OEM Part #01-90-3106

ROTARY PUMP OIL
• 4 fl. oz.
• ISO68
• Safety Data Sheet included
For: All Rotary Pumps (dispenses in oil reservoir)



RPI PART #GOW039
OEM PART #01-90-2876

1" OIL WICK
• 3 per package; White F-1 felt
Models: Fits rotary pumps with 1" rotor and 1/4 or 1/6 HP motor

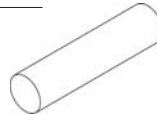

RPI PART #GOS038
OEM PART #01-90-0853

1" ROTOR SLIDE
• 3 per package; brass
Models: Fits rotary pumps with 1" rotor and 1/4 or 1/6 HP motor

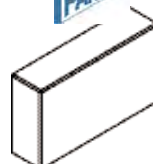

RPI Part #GOK017
OEM Part #01-90-2416

3/4" ROTOR SLIDE ASSEMBLY KIT
• Includes 3/4" rotor, and (3) 3/4" rotor slide
Fits: Pump Housing
Models: All 1/6 HP rotary pumps

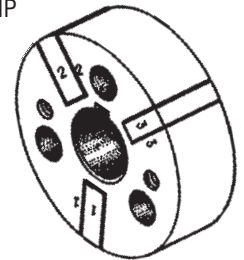

RPI Part #GOR028
OEM Part #01-90-2417

3/4" ROTOR
Fits: Pump Housing
Models: All 1/6 HP rotary pumps

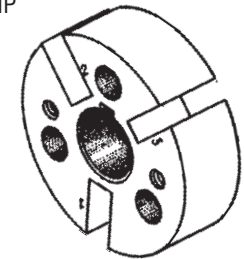

RPI PART #GOW035
OEM PART #01-90-2875

3/4" OIL WICK
• 3 per package; White F-1 felt
Models: Fits rotary pumps with 3/4" rotor and 1/6 HP motor

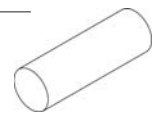

RPI Part #GOS029
OEM Part #01-90-2418

3/4" ROTOR SLIDE
• 3 per package; brass
Models: Fits rotary pumps with 3/4" rotor and 1/6 HP motor

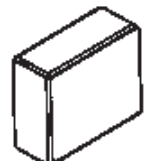

Also available to fit Thermotic Pumps

- Disp. Collection Canisters
 - Bacteria Filters
 - Rubber Bottle Cap
 - No. 8 Stopper
 - On/Off Switch
- See Section 2, page 200.*

RPI Part #GOS010
OEM Part #01-90-3050

MICRO-SWITCH

- 125/230/480 VAC
- 15 A
- 1/8 HP @ 125 VAC,
- 1/4 HP @ 250 VAC

Fits: Thermostat Heater Arm

Models: All electromechanical thermotic pumps with Bimetallic arm prior to PC board



RPI Part #GOV012
OEM Part #01-90-3432

PRESSURE VALVE (OUTLET)

Fits: Cylinder Assembly
Models: 764, 765A, 965A, 6000 (600), 6010 (601) & 6650

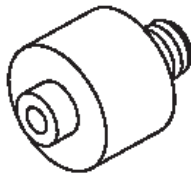

RPI Part #GOV011
OEM Part #01-90-3433

SUCTION VALVE (INLET)

Fits: Cylinder Assembly
Models: 764, 765A, 965A, 6000 (600), 6010 (601) & 6650

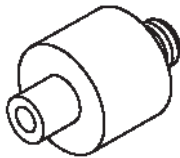

RPI Part #GOV013
OEM Part #01-90-8140

AEROVENT RUBBER VALVE

Fits: Aerovent Assembly
Models: All models with Aerovent valve



RPI Part #GOS031
OEM Part # (None)

HI/LOW SWITCH

- SPST
 - 3 A @ 250 VDC; 6 A @ 125 VAC
- Fits:** PC Board (RPI Part #GOB016) only
Models: 764 & 765A

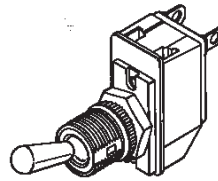

RPI Part #GOS030
OEM Part # (None)

ON/OFF SWITCH

- DPST
 - 3 A @ 250 VDC; 6 A @ 125 VAC
- Fits:** PC Board (RPI Part #GOB016) only
Models: 764 & 765A

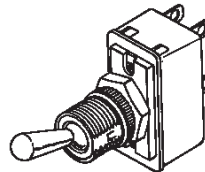

RPI Part #GOL026
OEM Part #01-90-3570

PILOT LAMP

- Lens: Red
- Type: Neon
- 125 VAC, 1/3 W

Fits: Fror
Models:

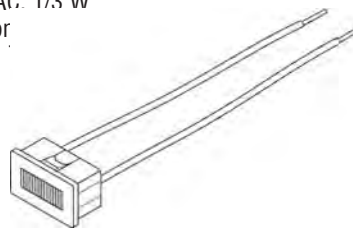

RPI Part #GOL032
OEM Part #01-90-2310

PUMP CYCLE LIGHT

- Lens: Amber
 - Type: Neon
 - 125 VAC
- Fits:** Front Panel
Models: 270, 6000 (600), 6010 (610), 6020 & 6650

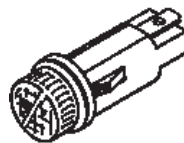

RPI Part #GOB023
OEM Part #01-90-2311

PC BOARD

- New style
 - 115 VAC
- Fits:** Case
Models: 6000 (600) & 6010 (601)

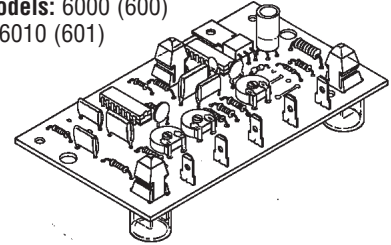

RPI Part #GOB016
OEM Part #01-90-3045

PC BOARD

- Old style
 - 115 VAC
- Fits:** Front Panel
Models: 764 & 765A

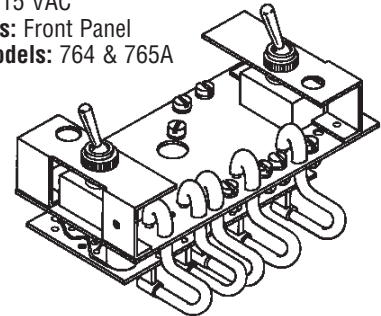

RPI Part #GOH005
OEM Part #01-90-2713

HEATER 115 VAC (160 Ω)

Fits: Cylinder Assembly
Models: 765A, 764, 6000 (600) & 6010 (601) all models using PC board

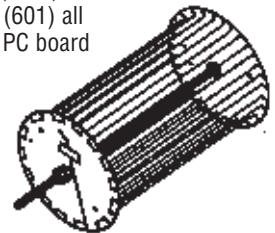

RPI Part #GOH004
OEM Part #01-90-2713

HEATER 115 VAC (149 Ω)

Fits: Cylinder Assembly
Models: All electro-mechanical thermotic pumps with Bimetallic arm prior to PC board

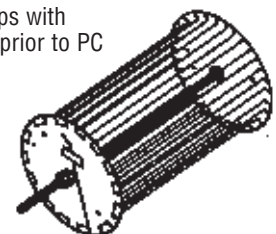

Aspirators & Pumps

Models: All J.R. Tompkins (100-65)

RPI Part #SKS001
OEM Part #02-9031

TOGGLE SWITCH

- DPST
- 6 A @ 125 VAC
- Includes push-on terminals, and wire nuts
- Mounts in base of machine

Model: J.R. Tompkins (100-65)

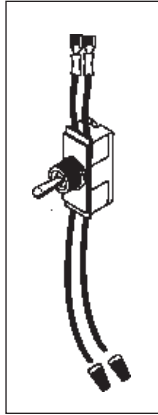

RPI Part #SKF012
OEM Part #02-4007

SUCTION AND PRESSURE FILTER ASSEMBLY

- Mounts off compressor side
- Model:** J.R. Tompkins (100-65)

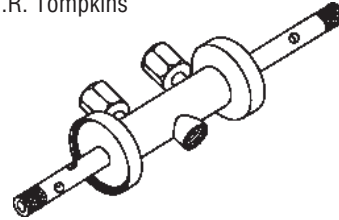

RPI Part #SKA009
OEM Part #02-6521

COMPRESSOR OUTLET ADAPTOR

- 1/8" MPT x 7/16-27
- Fits:** Compressor Section
Model: J.R. Tompkins (100-65)

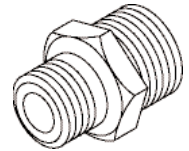

RPI Part #SKN003
OEM Part #02-4512

OPEN FILTER NUT

- 5/16-24 thread
 - Chrome plated
- Fits:** Suction and Pressure Filter Assembly

Model: J.R. Tompkins (100-65)



RPI Part #SKW015
OEM Part #02-4510

FILTER WINDOW

- Assembly requires two
- Fits:** Suction and Pressure Filter Assembly

Model: J.R. Tompkins (100-65)

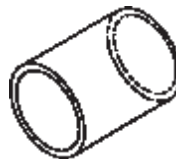

RPI Part #SKF008
OEM Part # (None)

RUBBER FOOT

- 4 per package
 - Mounts to bottom of base
- Model:** J.R. Tompkins (100-65)



RPI Part #SKG004
OEM Part #02-4506

FILTER CAP GASKET

- 2 per package
 - Assembly requires two
- Fits:** Filter Cap
Model: J.R. Tompkins (100-65)



RPI Part #SKG010
OEM Part #02-5101

VACUUM GAUGE

- 1.500" diameter dial
- 1/8" MPT, bottom mount
- Reads: 0-30 in. Hg.
- Mounts off suction and pressure filter assembly

Model: J.R. Tompkins (100-65)



RPI Part #SKS021
OEM Part #04-3501

NEEDLE VALVE REGULATOR SPRING

- **Fits:** Regulator
- Model:** J.R. Tompkins (100-65)

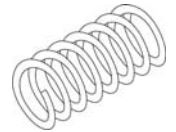

RPI Part #SKF005
OEM Part #04-5001

FELT FILTER

- 12 per package
- Assembly requires four

Fits: Window portion of Suction and Pressure Filter Assembly
Model: J.R. Tompkins (100-65)

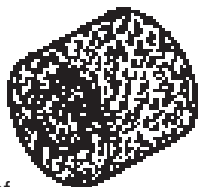

RPI Part #SKR007
OEM Part #2-6519

ROTOR BODY

- **Fits:** Compressor Section
- Model:** J.R. Tompkins (100-65)



RPI Part #SKS013
OEM Part #02-6506

ROTOR HOUSING PLATE SCREW

- 3 per package
 - Slotted fillister head
 - #8-32 x 1.230" long
 - Stainless steel
- Fits:** Rotor Housing Plate
Model: J.R. Tompkins (100-65)



RPI Part #SKC011
OEM Part #02-4513

FILTER CAP

- Assembly requires two
- Fits:** Suction and Pressure Filter Assembly
Model: J.R. Tompkins (100-65)



RPI Part #SKS006
OEM Part #02-6502

ROTOR SLIDE

- 3 per package
- Fits:** Rotor Body
Model: J.R. Tompkins (100-65)

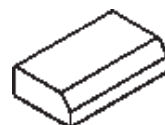

RPI Part #SKS014
OEM Part #02-6505

ROTOR HOUSING SCREW

- 3 per package
 - Slotted fillister head
 - #8-32 x .975" long
 - Stainless steel
- Fits:** Rotor Housing
Model: J.R. Tompkins (100-65)



CENTRIFUGES

BAXTER

Biofuge 17 & 17R	200
Cryofuge 6000	200
Haemofuge	200
Labofuge "A"	200
Medifuge	200
Megafuge	200
Omnifuge	200
Varifuge RF	200

BECKMAN

Microfuge "B"	303
Microfuge 11	303
Microfuge 12	303
Microfuge 152	303
TJ-6	303

BECKMAN/IRIS - STATSPIN® SERIES

CoagSpin (M940-22)	300-301
CritSpin (M960-12)	300-301
CritSpin (M961-22)	300-301
CytoFuge 2 (M801-22)	300-302
CytoVet (V801-22)	300-301
DiffSpin (M701-22)	300-301
Express 2 (M501-22)	300-302
MicroPrep (G600-22)	300-301
MP (M900-22)	300-301
MP (M901-22)	300-302
RP (M920-22)	300-301
VET Express (V501-22)	300-302
VT (V901-22)	300-302

BIO-DYNAMICS

#630 Select-A-Fuge	400-401
Universal #24	400-401
Uni-Meter #300	400-401

CLAY ADAMS

#0901 Tube Shields	513
#0908 Tube Shields	513
Analytical	512
Autocrit	500-501
Autocrit II	502
Autocrit Ultra III	503-504
Compact II	512
Cyclomixer	512
Dynac & Dynac II	504-506
Micro-Hematocrit	500-501
Micro-Hematocrit II	502
Micro-Hematocrit III	503-504
Physicians Compact & Physicians Jr.	512
QBC 4207	506

CENTRIFUGES *(continued)*

CLAY ADAMS *(continued)*

Readacrit & Readacrit MP	507-508
Safeguard	508
Safety-Head	508
Sero-Fuge & Sero-Fuge II	509-510
Triac	511
Yankee Pipette Shaker	512
Yankee Rotator	512

DRUCKER

L-708	600
L-711	600

EPPENDORF

3200	700
5402	700
5412	700
5413	700
5414	700
5415	700
5415C	700

HAMILTON BELL

VanGuard V-6000	800
VanGuard V-6500	800

IDEXX - STATSPIN® SERIES

VT (V901-22)	300-302
--------------	---------

IEC (International Equipment Co.)

B20-A (Late Model)	902
Centra-7	902
Centra-7R	902
CH	902
CL	902
CM	902
CRU5000	902
CS	902
CU5000	902
DPR6000	902
H	902
HN	902
HNS	902
HNS II	902
HT	902
K Size 2	902
MB Micro-Hematocrit	900-901
PR-6	902
PR-6000	902
PR-J	902
Spinette	901
UV	902

(continued)

Centrifuges & Other Lab Equipment

OEM MODEL Section 5 Page #'s

CENTRIFUGES *(continued)*

SORVALL

GLC-1	1000
GLC-2	1000
GLC-2B	1000
GLC-3	1000
GLC-4	1000
Motors Marked "Howard"	1000
RC-2B	1000
RC-3	1000
RC-3B	1000
RC-3C	1000
RC-5	1000
RC-5B	1000
RC-5C	1000
RT-6000	1000

NUTATORS & ROTATORS

CLAY ADAMS

421105 Nutator	1100
421106 Nutator	1100

LABNET INTERNATIONAL, INC.

H5500 Mini LabRoller™	1100
S0500 GyroMini™	1100
S0600 Enduro™ MiniMix™	1100

RPI Part #BAB001
OEM Part #002790/004936

BRUSH

- 2 per package
- Size: .252" x .390" x .866" lg.
- Radius: .937"
- No spring
- 1.610" copper shunt wire with 1/4" female push-on connector

Fits: Brush Holder Assembly
Model: Megafuge

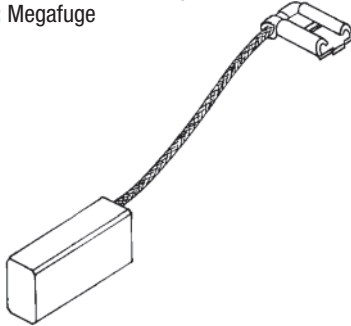

RPI Part #BAB004
OEM Part #001786

BRUSH

- 2 per package
- Size: .196" x .236" x .568" lg.
- Radius: .50"
- Spring length: 1.03"
- .925" copper shunt wire

Fits: Brush Holder Assembly
Model: Haemofuge

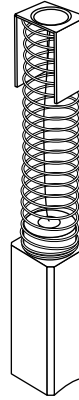

RPI Part #BAB006
OEM Part #003854

BRUSH

- 2 per package
- Size: .252" x .392" x .875" lg.
- Radius: .94"
- No spring
- 1.69" copper shunt wire with 1/4" female push-on connector and sensor wires

Fits: Brush Holder Assembly
Model: Omnifuge

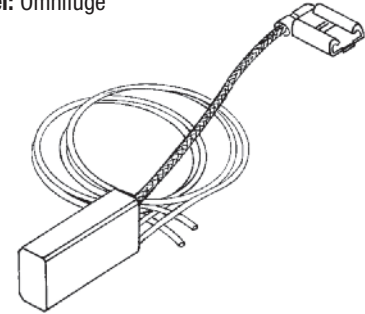

RPI Part #BAB005
OEM Part #002779

BRUSH

- 2 per package
- Size: .252" x .390" x .866" lg.
- Radius: .94"
- No spring
- 1.88" copper shunt wire with 1/4" female push-on connector

Fits: Brush Holder Assembly
Models: Biofuge 17 & Biofuge 17R

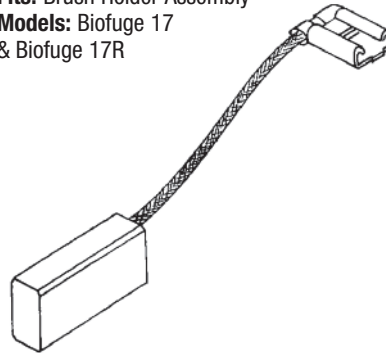

RPI Part #BAB002
OEM Part #001193

BRUSH

- 2 per package
- Size: .196" x .236" x .469" lg.
- Radius: .56"
- Spring length: 1.19"
- No shunt wire

Fits: Brush Holder Assembly
Model: Medifuge

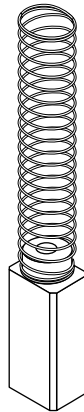

RPI Part #BAB007
OEM Part #001811

BRUSH

- 2 per package
- Size: .252" x .394" x .88" lg.
- Radius: .75"
- 1.94" copper shunt wire

Fits: Brush Holder Assembly
Model: Varifuge RF

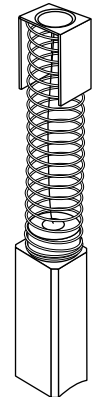

RPI Part #BAB003
OEM Part #001754

BRUSH

- 2 per package
- Size: .252" x .315" x .898" lg.
- Radius: .56"
- Spring length: 1.88"
- No shunt wire

Fits: Brush Holder Assembly
Model: Labofuge "A"

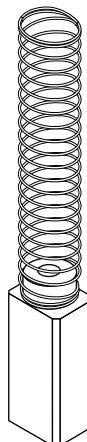

RPI Part #BAB008
OEM Part #006914

BRUSH

- 2 per package
- Size: .315" x .787" x .860" lg.
- No spring
- 3.88" copper shunt wire with red top pad and sensor wire

Fits: Brush Holder Assembly
Model: Cryofuge 6000

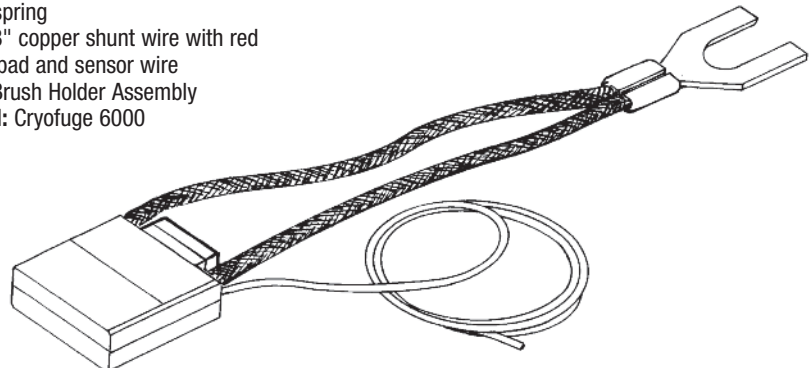

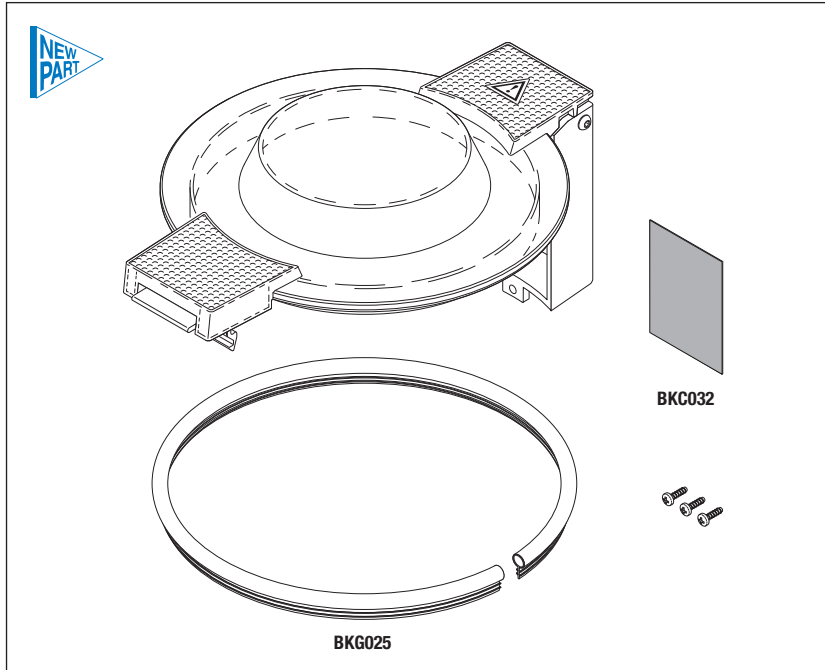

RPI Part #BKK019
OEM Part #X01-003494-001/X01-002528-00

TOP COVER ASSEMBLY

- Includes all parts as shown

Models:

BECKMAN/IRIS: CoagSpin (M940-22), CritSpin (M960-12), CritSpin (M961-22), CytoFuge 2 (M801-22), CytoVet (V801-22), DiffSpin (M701-22), Express 2 (M501-22), MicroPrep (G600-22), MP (M900-22), MP (M901-22), RP (M920-22), VT (V901-22) & VET Express (V501-22); and **IDEXX:** VT (V901-22)

RPI Part #BKC032
OEM Part # (No OEM Part # Available)



HINGE COVER

- Size: 1.64" x 2.20"; Color: Black
- Adhesive backing
- Included in: Top Cover Assembly (RPI Part #BKK019)

Fits: Hinge Housing

Models:

BECKMAN/IRIS: CoagSpin (M940-22), CritSpin (M960-12), CritSpin (M961-22), CytoFuge 2 (M801-22), CytoVet (V801-22), DiffSpin (M701-22), Express 2 (M501-22), MicroPrep (G600-22), MP (M900-22), MP (M901-22), RP (M920-22), VT (V901-22) & VET Express (V501-22); and **IDEXX:** VT (V901-22)

RPI Part #BKG025
OEM Part #X01-004635-001



BULB GASKET

- Length: 19.75"
- Included in: Top Cover Assembly (RPI Part #BKK019)

Models:

BECKMAN/IRIS: CoagSpin (M940-22), CritSpin (M960-12), CritSpin (M961-22), CytoFuge 2 (M801-22), CytoVet (V801-22), DiffSpin (M701-22), Express 2 (M501-22), MicroPrep (G600-22), MP (M900-22), MP (M901-22), RP (M920-22), VT (V901-22) & VET Express (V501-22); and **IDEXX:** VT (V901-22)

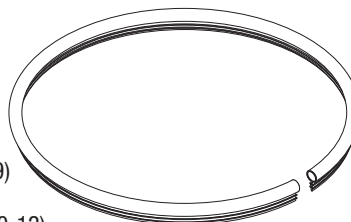

BKG025
 CROSS SECTION
 SHOWN ACTUAL SIZE

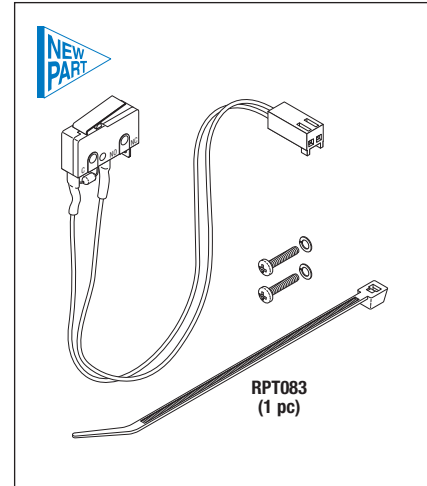

RPI Part #BKA026
OEM Part #X01-003495-001

SAFETY SWITCH ASSEMBLY

- 5A@250VAC; SPST
- Includes all parts as shown

Models:

BECKMAN/IRIS: CoagSpin (M940-22), CritSpin (M960-12), CritSpin (M961-22), CytoFuge 2 (M801-22), CytoVet (V801-22), DiffSpin (M701-22), Express 2 (M501-22), MicroPrep (G600-22), MP (M900-22), MP (M901-22), RP (M920-22), VT (V901-22) & VET Express (V501-22); and **IDEXX:** VT (V901-22)

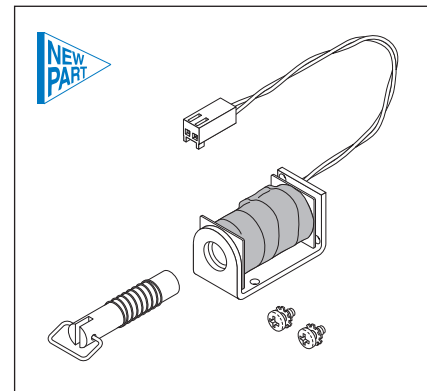

RPI Part #BKS027
OEM Part #X01-004076-001

SOLENOID

- Pull style 6 VDC
- Includes all parts as shown

Models:

BECKMAN/IRIS: CoagSpin (M940-22), CritSpin (M960-12), CritSpin (M961-22), CytoFuge 2 (M801-22), CytoVet (V801-22), DiffSpin (M701-22), Express 2 (M501-22), MicroPrep (G600-22), MP (M900-22), MP (M901-22), RP (M920-22), VT (V901-22) & VET Express (V501-22); and **IDEXX:** VT (V901-22)

Centrifuges

Models: StatSpin® Series

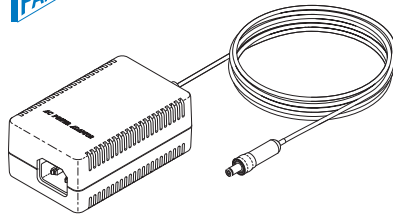

RPI Part #BKP034
OEM Part #X01-003553-001

POWER SUPPLY (SWITCHING)

- Input: 100-240VAC, 1.5A, 50-60 Hz.
- Output: 24 VDC, 2.5A
- Input Connector: EN60320-C13
- Output Connector: 5.5 mm (.218") OD Power Plug (for 2.1 mm (.064") Pin)
- Also available: Power Cord (RPI Part #RPC895)

Models:

BECKMAN/IRIS: CoagSpin (M940-22), CritSpin (M960-12), CritSpin (M961-22), CytoFuge 2 (M801-22), CytoVet (V801-22), DiffSpin (M701-22), Express 2 (M501-22), MicroPrep (G600-22), MP (M900-22), MP (M901-22), RP (M920-22), VT (V901-22) & VET Express (V501-22); and
IDEXX: VT (V901-22)

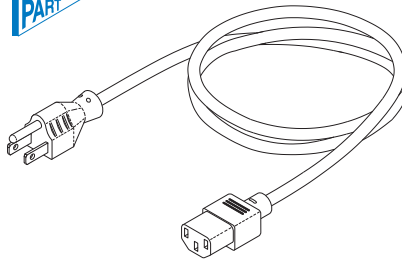

RPI Part #RPC895
OEM Part #X01-002532-001

POWER CORD

- Length: 8 ft.; Color: Black
- 18/3 SJT, 60°C; 10A@125VAC
- Plug: NEMA 5-15P
- Connector: EN60320-C13
- Also available: Power Supply (Switching) (RPI Part #BKP034)

Fits: Power Supply

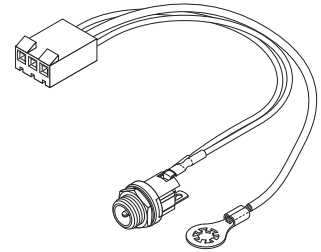

RPI Part #BKH035
OEM Part #X01-002529-001/X01-003493-001

POWER HARNESS

- Size: 6.25" lg.
- Includes: Mounting hardware

Models:

BECKMAN/IRIS: CoagSpin (M940-22), CritSpin (M960-12), CritSpin (M961-22), CytoFuge 2 (M801-22), CytoVet (V801-22), DiffSpin (M701-22), Express 2 (M501-22), MicroPrep (G600-22), MP (M900-22), MP (M901-22), RP (M920-22), VT (V901-22) & VET Express (V501-22); and
IDEXX: VT (V901-22)

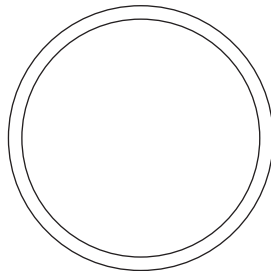

Shown
Actual Size



RPI Part #BK0037
OEM Part #X01-005532-001

O-RING (ROTOR HOLDER)

- 3 per package
- Material: Nitrile (Buna N), 70 Duro
- Size: 1.239" ID x 1.379" OD x .070" C/S

Fits: Rotor Holder

Models:

BECKMAN/IRIS: CoagSpin (M940-22), CritSpin (M960-12), CritSpin (M961-22), CytoFuge 2 (M801-22), CytoVet (V801-22), DiffSpin (M701-22), Express 2 (M501-22), MicroPrep (G600-22), MP (M900-22), MP (M901-22), RP (M920-22), VT (V901-22) & VET Express (V501-22); and
IDEXX: VT (V901-22)

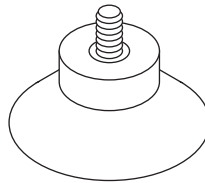

RPI Part #RPF894
OEM Part #X01-004288-001

SUCTION FEET

- 4 per package
- Material: Black isoprene
- Size: 1.00" dia. x .44" lg. with #8-32 x .25" lg. stud

Models:

BECKMAN/IRIS: DiffSpin (M701-22), Express 2 (M501-22), MP (M901-22), VT (V901-22) & VET Express (V501-22); and
IDEXX: VT (V901-22)



RPI Part #RPB896
OEM Part #X01-002542-001

BUMPER / FOOT

- 4 per package
- Material: Black non-marking polyurethane
- Size: .44" dia. x .20" h
- Adhesive backing
- Included in: Latch Kit (RPI Part #BKK020), Latch Kit (RPI Part #BKK021), Latch Kit (RPI Part #BKK022), and Latch Kit (RPI Part #BKK023)

Models:

BECKMAN/IRIS: CoagSpin (M940-22), CritSpin (M960-12), CritSpin (M961-22), CytoFuge 2 (M801-22), CytoVet (V801-22), MicroPrep (G600-22), MP (M900-22) & MP (M901-22); and
IDEXX: VT (V901-22)

RPI Part #BKK020
OEM Part #

(No OEM Part # Available)

LATCH KIT

- Includes all parts as shown

Models:

BECKMAN/IRIS: VT (V901-22); and
IDEXX: VT (V901-22)

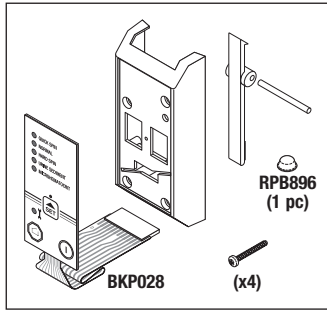

RPI Part #BKK022
OEM Part #

(No OEM Part # Available)

LATCH KIT

- Includes all parts as shown

Model:

BECKMAN/IRIS: CritSpin (M961-22)

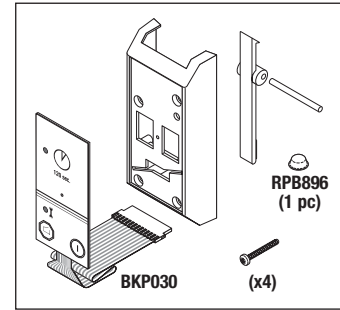

RPI Part #BKP028
OEM Part #X01-003943-001

MEMBRANE PANEL

- Size: 1.65" W x 3.47" L

- Adhesive backing

Fits: Latch Housing

Models:

BECKMAN/IRIS: VT (V901-22); and
IDEXX: VT (V901-22)

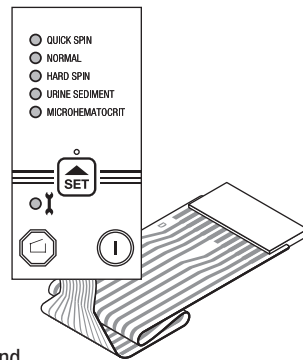

RPI Part #BKP030
OEM Part #X01-005203-001

MEMBRANE PANEL

- Size: 1.65" W x 3.47" L

- Adhesive backing

Fits: Latch Housing

Model:

BECKMAN/IRIS: CritSpin (M961-22)

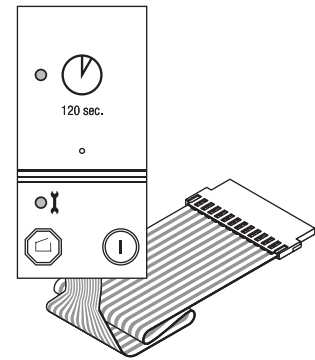

RPI Part #BKK021
OEM Part #

(No OEM Part # Available)

LATCH KIT

- Includes all parts as shown

Model:

BECKMAN/IRIS: MP (M901-22)

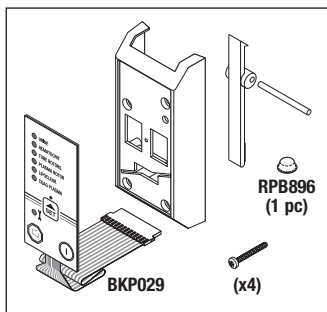

RPI Part #BKK023
OEM Part #

(No OEM Part # Available)

LATCH KIT

- Includes all parts as shown

Models:

BECKMAN/IRIS: Express 2 (M501-22)
& Vet Express (V501-22)

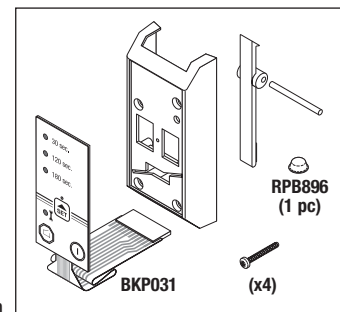

RPI Part #BKP029
OEM Part #X01-005171-001

MEMBRANE PANEL

- Size: 1.65" W x 3.47" L

- Adhesive backing

Fits: Latch Housing

Model:

BECKMAN/IRIS: MP (M901-22)

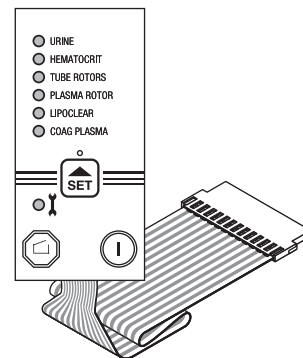

RPI Part #BKP031
OEM Part #X01-003944-001

MEMBRANE PANEL

- Size: 1.65" W x 3.47" L

- Adhesive backing

Fits: Latch Housing

Models:

BECKMAN/IRIS: Express 2 (M501-22)
& Vet Express (V501-22)

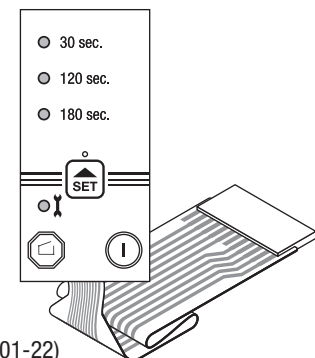

Centrifuges

Models: Microfuge "B", Microfuge 11, Microfuge 12, Microfuge 152 & TJ-6

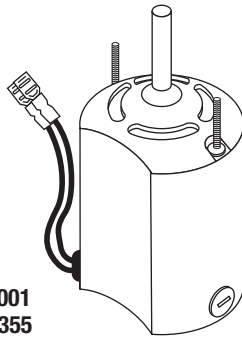

RPI Part #BKM001
OEM Part #314355

UNIVERSAL MOTOR

- 110 VAC, 50/60 Hz.
 - Maximum operating speed: 11,900 RPM
 - Sustaining current: 1A or less
- Model:** Microfuge 152



RPI Part #RPC036
OEM Part # (No OEM Part # Available)

BRUSH CAP

- 6 per package
 - 1/2-27 thread
- Fits:** Motor (RPI Part #BKM001)
Model: Microfuge 152

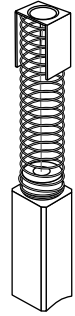

RPI Part #BKB005
OEM Part # (No OEM Part # Available)

BRUSH

- 2 per package
 - Size: .250" x .250" x .750" lg.
 - Radius: 1.00"
 - .75" lg. copper braided shunt wire
- Fits:** Brush Holder Assembly
Model: Microfuge 152

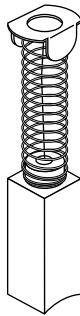

RPI Part #BKB003
OEM Part #340536

BRUSH

- 2 per package
 - Size: .250" x .375" x .797" lg.
 - Radius: .72"
 - 1.17" lg. copper braided shunt wire
- Fits:** Brush Holder Assembly
Model: TJ-6

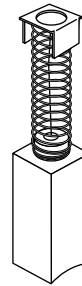

RPI Part #BKB004
OEM Part #343662

BRUSH

- 2 per package
 - Size: .250" x .375" x .875" lg.
 - Radius: 1.00"
 - 1.38" lg. copper braided shunt wire
- Fits:** Brush Holder Assembly
Model: Microfuge 11 & Microfuge 12

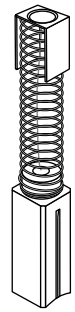

RPI Part #BKB006
OEM Part #343156

BRUSH

- 2 per package
 - Size: .250" x .250" x .500" lg.
 - Radius: .44"
 - .75" lg. copper braided shunt wire
- Fits:** Brush Holder Assembly
Model: Microfuge "B"

**For quality replacement parts, you can depend on RPI.
Your 100% satisfaction is guaranteed!**

NOTES: _____

RPI Part #BDA008
OEM Part #1-30015

SHAFT ADAPTOR
Fits: Motor Shaft
Model: #630
Select-A-Fuge

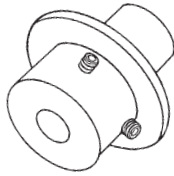

RPI Part #BDA015
OEM Part #1-61716

HEAD COVER ASSEMBLY
Fits: Motor Shaft
Model: #630
Select-A-Fuge

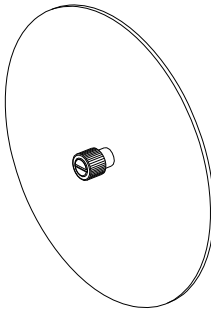

RPI Part #BDB001
OEM Part #919808

BRUSH
• 2 per package
• Size: 1/4 x .190 x 21/32
• Spring Length: 1-1/8"
• Copper shunt wire
Fits: Brush Holder Assembly
Models: Universal #24
& #630 Select-A-Fuge
(Serial #71000 and above)



RPI Part #BDB002
OEM Part #919807

BRUSH
• 2 per package
• Size: 1/4 x 1/8 x 21/32
• Spring Length: 1-3/8"
Fits: Brush Holder Assembly
Models: #630 Select-A-Fuge
(Serial #70999 and below)

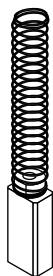

RPI Part #BDC006
OEM Part #1-61705

SPEED CONTROL
• Mounts in control panel
Model: #630
Select-A-Fuge

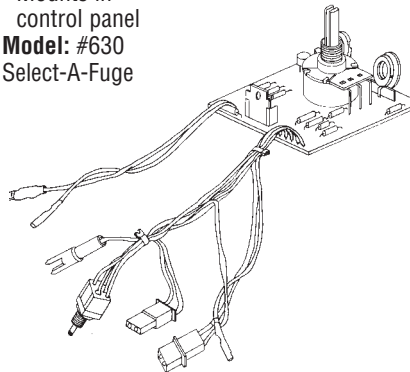

RPI Part #BDF009
OEM Part #1-06307

FOOT
• 4 per package
• Suction cup style
8-32 x 3/8 stud
Model: #630 Select-A-Fuge

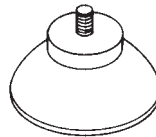

RPI Part #BDG003
OEM Part #61706

LID GASKET
Fits: Housing Assembly
Model: #630 Select-A-Fuge

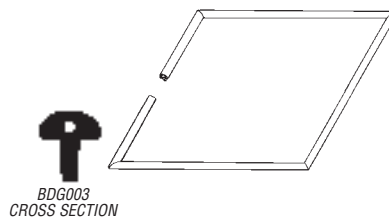

RPI Part #BDG004
OEM Part #106332

HEMATOCRIT GASKET
Fits: Head Assembly
Model: #630
Select-A-Fuge



RPI Part #BDL011
OEM Part #1-06345

BRAKE LOCK LINING
• 12 per package
Fits: Brake Assembly
Model: #630 Select-A-Fuge

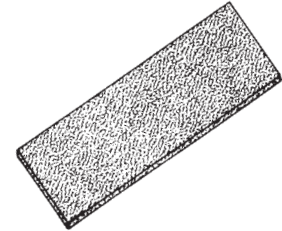

RPI Part #BDM007
OEM Part #1-61703

MOTOR ASSEMBLY
• 115VAC, 60 Hz., 1/10 HP, 10,000 RPM
• Includes motor, and
(2) wiring connector
Model: #630
Select-A-Fuge

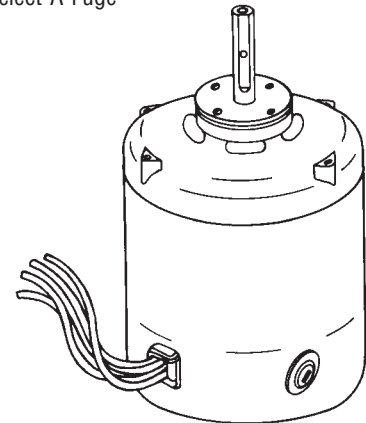

RPI Part #BDN013
OEM Part #1-06304

HEAD COVER NUT
Fits: Head Assembly
Model: #630
Select-A-Fuge

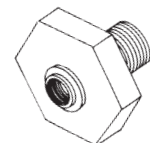

**Orders placed before
2:00 P.M.
(Pacific Time)
will be shipped the
same day.**

Centrifuges

Models: #630 Select-A-Fuge, Universal #24 & Uni-Meter #300 (continued)

RPI Part #BDP018
OEM Part #238234

CALIBRATION POTENTIOMETER

Fits: Control Panel
Model: Uni-Meter #300

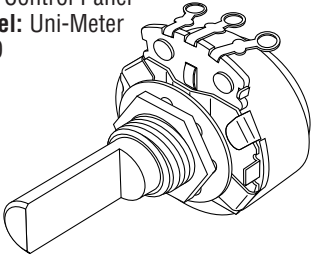

RPI Part #BDS010
OEM Part #1-06341

BRAKE LOCK SPRING

• 5 per package
Fits: Brake Assembly
Model: #630 Select-A-Fuge

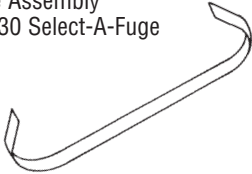

RPI Part #BDS019
OEM Part #224139

POWER SWITCH

• DPST
• 1A, 250VAC; 5A, 125VAC
• Mounts in Control Panel

Model: Uni-Meter #300

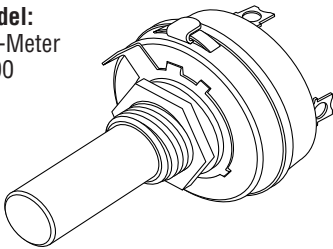

RPI Part #BDT005
OEM Part #106302

MECHANICAL TIME SWITCH

• SPST
• 5 minutes
• Switch: 16A, 125/250VAC
• Includes timer, face plate, and mounting screws
• Switch is slightly larger than OEM's;
No push button start
• Mounts in Control Panel
Model: #630 Select-A-Fuge

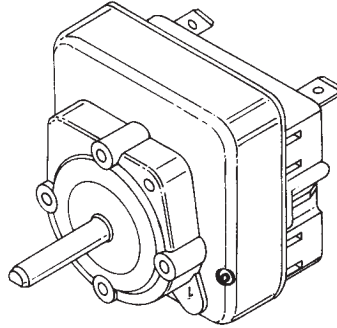

RPI Part #BDT017
OEM Part #105015

MECHANICAL TIMER WITH BELL

• 30 minutes
• Includes timer, and mounting nut
Model: Uni-Meter #300

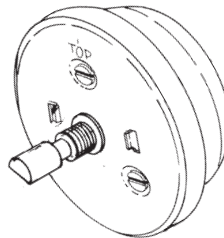

NOTES: _____

MOTORS & BRUSHES TO FIT CLAY ADAMS CENTRIFUGES

MODEL	MOTOR REPLACEMENT	RPI MOTOR BRUSH & CAP REPLACEMENT		OEM MOTOR BRUSH & CAP REPLACEMENT	
		Brush	Cap	Brush	Cap
Autocrit	CAM115	CAB018	RPC036	CAB018	RPC036
Autocrit II	CAM115	CAB018	RPC036	CAB018	RPC036
Autocrit Ultra III	CAM115	CAB018	RPC036	CAB018	RPC036
Compact II	CAM102				
Dynac	CAM026	CAB018	RPC036*	CAB019	
Dynac II		CAB018			
Micro-Hematocrit	CAM115	CAB018	RPC036	CAB018	RPC036
Micro-Hematocrit II	CAM115	CAB018	RPC036	CAB018	RPC036
Micro-Hematocrit III	CAM115	CAB018	RPC036	CAB018	RPC036
Readacrit	CAM024	CAB022	RPC039	CAB022	RPC039
Readacrit MP	CAM024	CAB022	RPC039	CAB022	RPC039
Safeguard		CAB018			
Serofuge					
Serofuge II	CAM101	CAB083			
Triac	CAM025	CAB018	RPC036	CAB018	RPC036
Triac II	CAM027	CAB018	RPC036	CAB018	RPC036

* This Cap (RPI Part #RPC036) only fits the RPI Motor (RPI Part #CAM026). This Cap does not fit the OEM Motor.

Models: Autocrit & Micro-Hematocrit

RPI Part #CAM115
OEM Part # 42055801

LOOK...
ONE RPI MOTOR FITS
ALL MODELS!

MOTOR & SPINDLE ASSEMBLY*

- 120VAC, 60 Hz.; 11,700 RPM (+22%, -10%)
- Includes motor, and mounting plate* (head adapter and aluminum mounting plate installed)
- Replacement Brush: RPI Part #CAB018;
- Replacement Cap: RPI Part #RPC036

Fits: Centrifuge housing

Models: Autocrit I & II, Autocrit Ultra III and Micro-Hematocrit I, II & III

*RPI offers one motor that fits all models, plus a FREE mounting plate!
About the mount plate: Since the head adapters on the old style motor assemblies cannot be removed on the Autocrit I & III and Micro-Hematocrit I & III, RPI will give you a **FREE** new mounting plate!

- Round style mounting plate fits the Autocrit I and Micro-Hematocrit I.
- Triangular style mounting plate fits the Autocrit III and Micro-Hematocrit III.
- Mounting plate that fits the Autocrit II and Micro-Hematocrit II comes standard with the RPI motor.

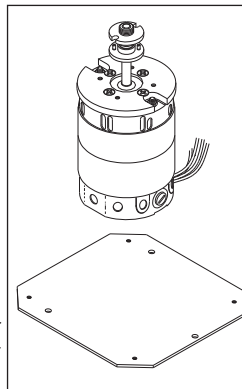

RPI Part #CAC048
OEM Part # N/A

MOTOR MOUNTING GASKET

Fits: Mounting Plate
Models: Autocrit & Micro-Hematocrit

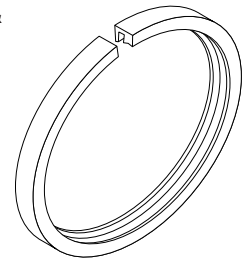

RPI Part #CAB017
New OEM Part #42055102
Old OEM Part #0551-600-001

BRUSH

- 2 per package
- Size: 9/32" x 9/32" x 3/4"
- Radius: 1/2"; Spring Length: 1-1/4"

Fits: Brush Holder Assembly on older model

OEM Motors

Models: Autocrit & Micro-Hematocrit

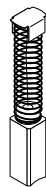

RPI Part #RPC037

BRUSH CAP WITH INSERT

- 6 per package
- 3/8-24 thread

Fits: Motor (RPI Part #CAM049)

Models: Autocrit & Micro-Hematocrit



New RPI Part #IEB024

Old RPI Part #DAB024

OEM Part # N/A

BRUSH

- 2 per package
- Size: 1/4" x 1/4" x 21/32"
- Radius: .725"
- Spring length: 1.0"; Copper shunt wire

Fits: Motor (RPI Part #CAM049, CAM050 & IEM025) only

Model: Autocrit & Micro-Hematocrit



RPI Part #CAS009
New OEM Part #42055113
Old OEM Part #0551-606-000

SHOCK MOUNT ASSEMBLY

- 4 assemblies per package
- Includes (4) #8-32 x 2" Phillips pan head screw, (4) #8 flat washer, (4) .265" ID x .500" OD x .062" THK flat washer, (4) #8-32 hex nut, (4) #8-32 flex lock nut, (4) spacer, (4) rubber ball mount, (8) split key ring, and (8) #8 external tooth washer
- All hardware stainless steel

Fits: Mounting Plate

Models: Autocrit & Micro-Hematocrit

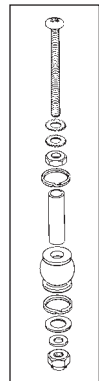

RPI Part #CAB018
OEM Part #42000102

BRUSH

- 2 per package
- Size: 1/4" x 1/4" x 3/4"
- Radius: 1.0"; Spring Length: 7/8"

Fits: Brush Holder Assembly

Models: Autocrit & Micro-Hematocrit

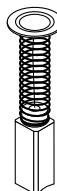

Call Us Toll-Free Monday-Friday, 8:00 AM-4:30 PM (Pacific Time), (800) 221-9723

Centrifuges

Models: Autocrit & Micro-Hematocrit (continued)

RPI Part #CAA001
OEM Part # N/A

HEAD ADAPTER ASSEMBLY

- Includes all parts as shown
- Fits:** Pressed on Shaft of Motor
- Models:** Autocrit & Micro-Hematocrit

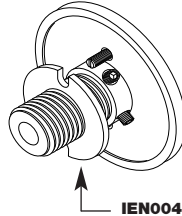

RPI Part #CAK002
OEM Part # N/A

HEAD COVER KNOB ASSEMBLY

- Includes retaining ring
- Fits:** Head Adaptor
- Model:** Autocrit

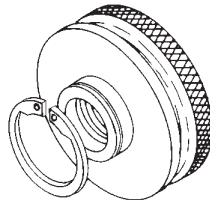

RPI Part #CAK003
OEM Part # N/A

HEAD COVER KNOB

- Fits:** Head Adaptor
- Model:** Micro-Hematocrit

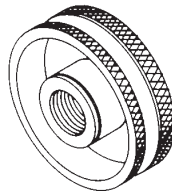

RPI is your best source for quality replacement parts!

RPI Part #CAS052
New OEM Part #42055107
Old OEM Part #0551-602-000

SAFETY SWITCH

- DPDT
- 6A, 125VAC;
- 3A, 250VAC
- Mounts below latch assembly
- Models:** Autocrit & Micro-Hematocrit

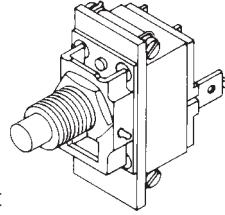

RPI Part #CAF014
New OEM Part #42055114
Old OEM Part #0551-607-000

SUCTION CUP FOOT

- 4 per package
- 3/4 high shoulder
- #8-32 x 3/8 stud
- Mounts to base plate
- Models:** Autocrit & Micro-Hematocrit

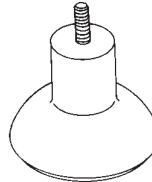

RPI Part #CAH032
New OEM Part #42055112
Old OEM Part #0551-605-001

RUBBER HEADLINER

- 3 per package
- Fits:** Head Assembly
- Models:** Micro-Hematocrit

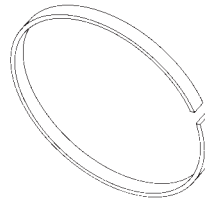

CAH032
 CROSS SECTION

RPI Part #CAL033
New OEM Part #42058001
Old OEM Part #0580-607-000

RUBBER CARRYING TRAY LINER

- Models:** Autocrit

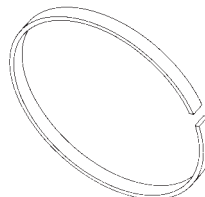

CAL033
 CROSS SECTION

RPI Part #CAC015
New OEM Part #42054109
Old OEM Part #0541-603-000

POWER CORD

- 18/3 SJT, 10A@125V
- 60°C
- Includes grommet
- Length: 8 ft.
- Models:** Autocrit & Micro-Hematocrit

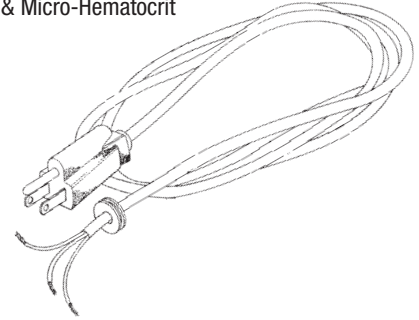

NOTES: _____

Cross section illustrations are actual size. Where practical, cut old part to match with cross section illustration.

RPI Part #CAA053
OEM Part # N/A
HEAD ADAPTER ASSEMBLY
Fits: Pressed on Shaft of Motor
Models: Autocrit II & Micro-Hematocrit II



RPI Part #CAK002
OEM Part # N/A
HEAD COVER KNOB ASSEMBLY
 • Includes retaining ring
Fits: Shaft Adaptor
Model: Autocrit II

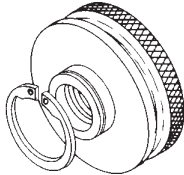

RPI Part #CAK003
OEM Part # N/A
HEAD COVER KNOB
Fits: Shaft Adaptor
Model: Micro-Hematocrit II

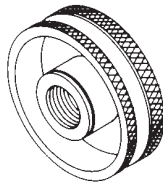

RPI Part #CAB017
New OEM Part #42055102
Old OEM Part #0551-600-001
BRUSH
 • 2 per package
 • Size: 9/32 x 9/32 x 3/4
 • Radius: 1/2"
 • Spring Length: 1-1/4"
Fits: Brush Holder Assembly
Models: Micro-Hematocrit II

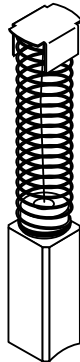

RPI Part #CAB018
New OEM Part #42000102
Old OEM Part #0001-600-001
BRUSH
 • 2 per package
 • Size: 1/4 x 1/4 x 3/4
 • Radius: 1.0"
 • Spring Length: 7/8"
Fits: Brush Holder Assembly
Models: Autocrit II & Micro-Hematocrit II

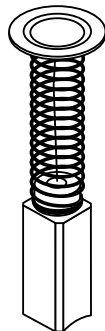

RPI Part #CAS051
New OEM Part #42055806
Old OEM Part #0558-602-000
SAFETY SWITCH
 • SPDT
 • 15A, 125VAC;
 10A, 250VAC;
 1/2HP, 250VAC
Fits: Control Panel
Models: Autocrit II & Micro-Hematocrit II

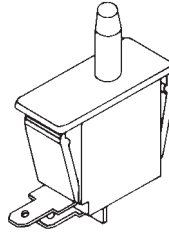

RPI Part #CAT074
New OEM Part #42055805
Old OEM Part #0558-601-000
ELECTRIC TIME SWITCH (15 MINUTES)
 • DPDT
 • 15A, 120-250VAC
 • Body of RPI timer is slightly larger than OEM's; *Inner dial* on OEM timer rotates to indicate time—*Outer dial* on RPI timer rotates to indicate time; Rewire per RPI instructions (included)
 • Includes timer, and face plate
Fits: Control Panel
Models: Autocrit II & Micro-Hematocrit II

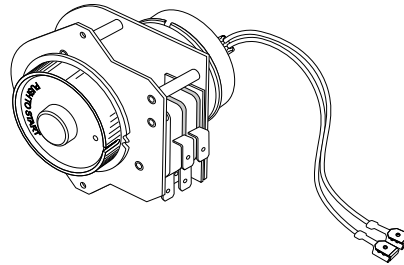

RPI Part #CAL082
New OEM Part #42010110 & 42055811
Old OEM Part #0101-606-000 & 0558-615-000

PILOT LIGHT
 • Red
 • 125VAC, 1/3W
Models: Autocrit II & Micro-Hematocrit II

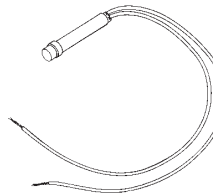

Quantity price breaks are available on all parts.

RPI Part #CAH032
New OEM Part #42055112
Old OEM Part #0551-605-001
RUBBER HEADLINER
 • 3 per package
Fits: Head Assembly
Models: Micro-Hematocrit II

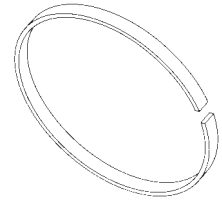

CAH032
 CROSS SECTION

RPI Part #CAL033
New OEM Part #42058001
Old OEM Part #0580-607-000
RUBBER CARRYING TRAY LINER
Models: Autocrit II

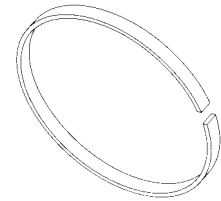

CAL033
 CROSS SECTION

RPI Part #CAL054
New OEM Part #42048003
Old OEM Part #0580-609-000
RUBBER HUB LINER
 • 3 per package
Fits: Hub Section of Carrying Tray
Models: Autocrit II & Micro-Hematocrit II

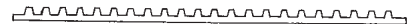

RPI Part #CAC015
New OEM Part #42054109
Old OEM Part #0541-603-000
POWER CORD
 • 18/3 SJT, 15A, 125V
 • Length: 8 ft.
Models: Autocrit II & Micro-Hematocrit II

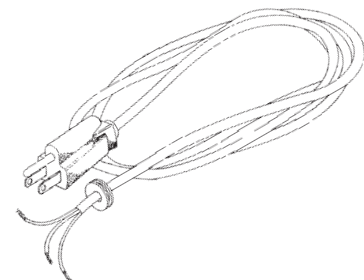

Centrifuges

Models: Autocrit Ultra III & Micro-Hematocrit III

RPI Part #CAM050
New OEM Part #42057501
Old OEM Part #0575-600-000

MOTOR ASSEMBLY

- Replaces motor with three dimensional mounting plate only—will not work with flat mounting plate
- 120VAC, 60 Hz., 11,700 RPM, +22%, -10%
- Body of RPI motor is slightly larger than OEM's; Requires RPI brushes; Rewire per RPI instructions (included)
- Includes motor, mounting plate, shaft adaptor, and spanner nut

Models: Autocrit Ultra III & Micro-Hematocrit III

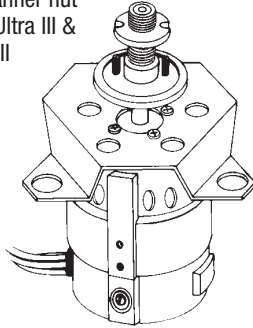

RPI Part #RPC037

BRUSH CAP WITH INSERT

- 6 per package
 - 3/8-24 thread
 - Fits: Motor (RPI Part #CAM050)
- Models: Autocrit Ultra III & Micro-Hematocrit III



RPI Part #CAA053
OEM Part # N/A

HEAD ADAPTER ASSEMBLY

- Fits: Pressed on Shaft of Motor
- Models: Autocrit Ultra III & Micro-Hematocrit III

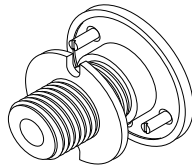

New RPI Part #IEB024
Old RPI Part #DAB024
OEM Part # N/A

BRUSH

- 2 per package
 - Size: 1/4 x 1/4 x 21/32
 - Radius: .725"
 - Spring length: 1.0"
 - Copper shunt wire
 - Fits: Motor (RPI Part #CAM049, CAM050 & IEM025) only
- Model: Autocrit, Autocrit Ultra III & Micro-Hematocrit III

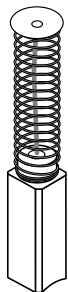

RPI Part #CAB017
New OEM Part #42055102
Old OEM Part #0551-600-001

BRUSH

- 2 per package
 - Size: 9/32 x 9/32 x 3/4
 - Radius: 1/2"
 - Spring Length: 1-1/4"
 - Fits: Brush Holder Assembly
- Models: Micro-Hematocrit III

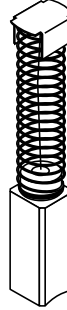

RPI Part #CAB018
New OEM Part #42000102
Old OEM Part #0001-600-001

BRUSH

- 2 per package
 - Size: 1/4 x 1/4 x 3/4
 - Radius: 1.0"
 - Spring Length: 7/8"
 - Fits: Brush Holder Assembly
- Models: Autocrit Ultra III & Micro-Hematocrit III

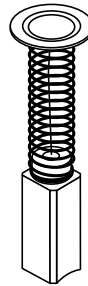

RPI Part #CAT074
New OEM Part #42055805
Old OEM Part #0558-601-000

ELECTRIC TIME SWITCH (15 MINUTES)

- DPDT
 - 15A, 120-250VAC
 - Body of RPI timer is slightly larger than OEM's; *Inner* dial on OEM timer rotates to indicate time—*Outer* dial on RPI timer rotates to indicate time; Rewire per RPI instructions (included)
 - Includes timer, and face plate
 - Fits: Control Panel
- Models: Autocrit Ultra III & Micro-Hematocrit III

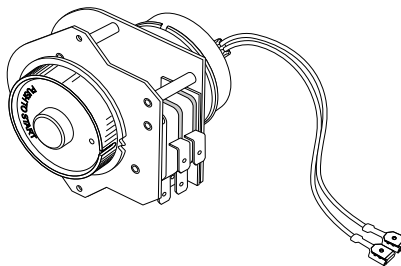

RPI Part #CAS051
New OEM Part #42055806
Old OEM Part #0558-602-000

SAFETY SWITCH

- SPDT
 - 15A, 125VAC; 10A, 250VAC; 1/2HP, 250VAC
 - Fits: Control Panel
- Models: Autocrit Ultra III & Micro-Hematocrit III

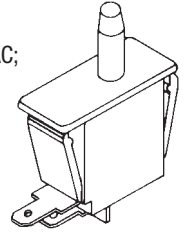

RPI Part #CAL082
New OEM Part #42010110 & 42055811
Old OEM Part #0101-606-000 & 0558-615-000

PILOT LIGHT

- Red
 - 125VAC, 1/3W
- Models: Autocrit Ultra III

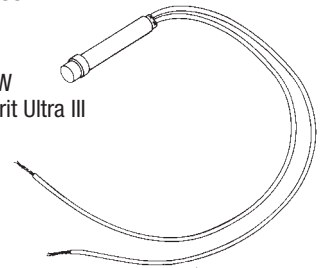

RPI Part #CAS052
New OEM Part #42055107
Old OEM Part #0551-602-000

SAFETY SWITCH

- DPDT
 - 6A, 125VAC; 3A, 250VAC
 - Mounts below latch assembly
- Models: Autocrit Ultra III

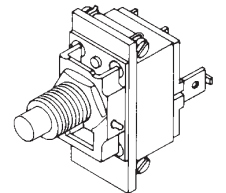

RPI Part #CAH032
New OEM Part #42055112
Old OEM Part #0551-605-001

RUBBER HEADLINER

- 3 per package
 - Fits: Head Assembly
- Models: Micro-Hematocrit III



CAH032 CROSS SECTION

Cross section illustrations are actual size. Where practical, cut old part to match with cross section illustration.

RPI Part #CAL033
New OEM Part #42058001
Old OEM Part #0580-607-000

RUBBER CARRYING TRAY LINER
Models: Autocrit Ultra III

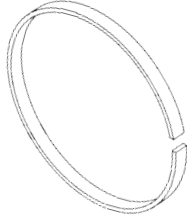

CAL033
CROSS SECTION

RPI Part #CAL054
New OEM Part #42048003
Old OEM Part #0580-609-000

RUBBER HUB LINER
• 3 per package
Fits: Hub Section of Carrying Tray
Models: Autocrit Ultra III
& Micro-Hematocrit III



RPI Part #CAC015
New OEM Part #42054109
Old OEM Part #0541-603-000

POWER CORD
• 18/3 SJT, 15A, 125V
• Length: 8 ft.
Models: Autocrit Ultra III
& Micro-Hematocrit III

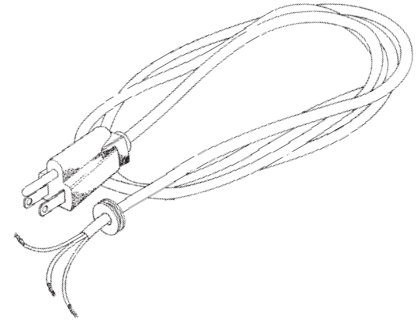

Cross section illustrations are actual size. Where practical, cut old part to match with cross section illustration.

Models: Dynac & Dynac II

RPI Part #CAM026
New OEM Part #42010101
Old OEM Part #0101-600-000

MOTOR ASSEMBLY
• 120VAC, 60 Hz., 3600 RPM max.
• Includes motor, gasket, and mounting hardware
• Use RPI Part #CAB019 for replacement brushes
Model: Dynac

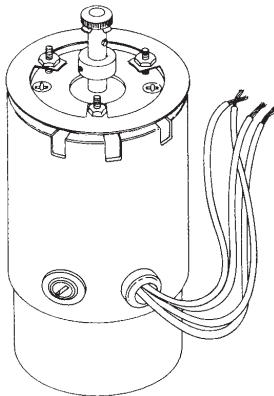

RPI Part #CAI080
New OEM Part #42010318
Old OEM Part #0103-612-000

VIBRATION ISOLATOR
• 3 per package
• Mounts on motor mounting plate
Model: Dynac II

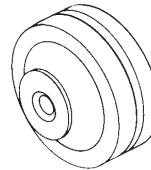

RPI Part #CAB019
OEM Part # N/A

BRUSH
• 2 per package
• Size: 1/4 x 1/4 x 3/4
• Radius: 1.0"
• Spring Length: 7/8"
Fits: Motor (RPI Part #CAM026) only
Model: Dynac

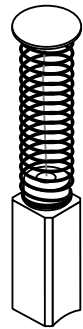

RPI Part #CAC016
New OEM Part #42010108
Old OEM Part #0101-605-000

SPEED CONTROL ASSEMBLY
• Includes speed control, knob, and mounting hardware
• Mounts to instrument panel
Model: Dynac

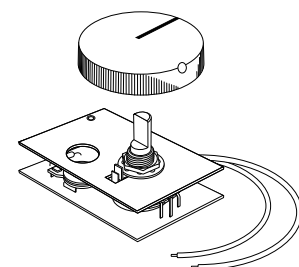

RPI Part #RPC036
BRUSH CAP WITH INSERT
• 6 per package
• 3/8-24 thread
Fits: Motor (RPI Part #CAM026)
Models: Dynac

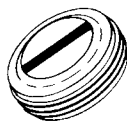

RPI Part #CAB018
New OEM Part #42000102
Old OEM Part #0001-600-001

BRUSH
• 2 per package
• Size: 1/4 x 1/4 x 3/4
• Radius: 1.0"
• Spring Length: 7/8"
Fits: Brush Holder Assembly
Models: Dynac & Dynac II

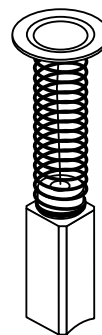

Centrifuges

Models: Dynac & Dynac II (continued)

RPI Part #CAC072
 New OEM Part #42010311
 Old OEM Part #0103-605-000

SPEED CONTROL

- Includes speed control, and mounting hardware
 - Mounts to instrument panel
- Model: Dynac II

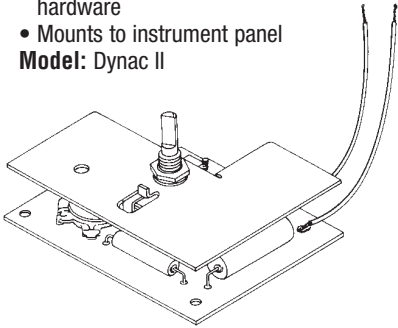

RPI Part #CAM078
 New OEM Part #42010317
 Old OEM Part #0103-610-000

TACH METER

- Mounts in control panel
- Model: Dynac II

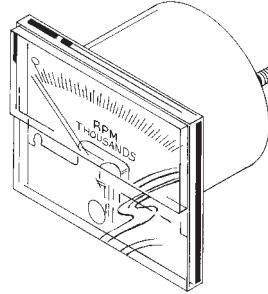

RPI Part #CAT044
 New OEM Part #42010103
 Old OEM Part #0101-601-000

MECHANICAL TIME SWITCH (30 minutes)

- SPST
- 15A, 120-240VAC;
- 1/3HP, 120-240VAC
- Includes timer with switch, knob, and mounting nut

Fits: Control Panel
 Model: Dynac

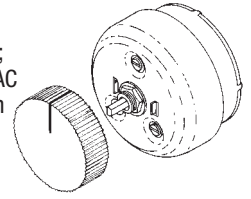

RPI Part #CAA075
 New OEM Part #42010320
 Old OEM Part #0103-614-000

TACHOMETER PC BOARD ASSEMBLY

- Mounts to base plate
- Model: Dynac II

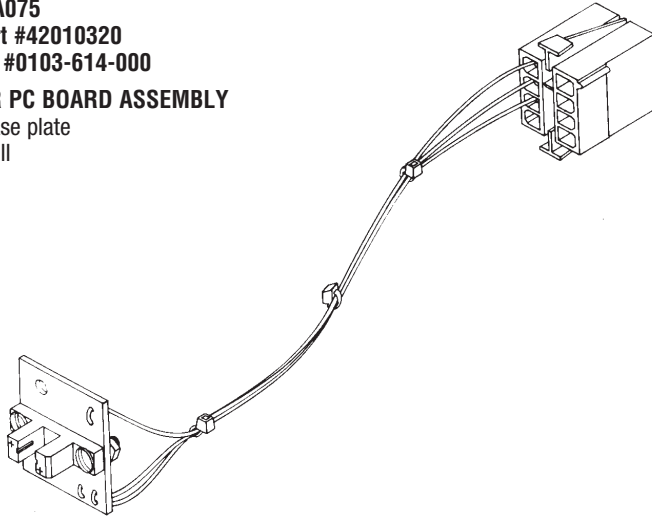

RPI Part #CAT062
 New OEM Part #42010304
 Old OEM Part #0103-601-001

ELECTRIC TIME SWITCH (30 minutes)

- SPDT
- 15A, 120-250VAC;
- 1/2HP, 120-250VAC

Fits: Control Panel
 Model: Dynac II

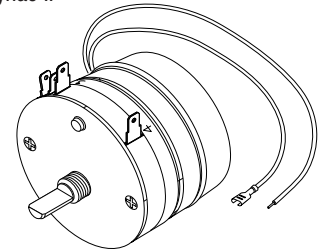

RPI Part #CAS079
 New OEM Part #42010313
 Old OEM Part #0103-607-000

SOLENOID ASSEMBLY

- Includes coupling
- Fits: Solenoid Bracket Assembly
 Model: Dynac II

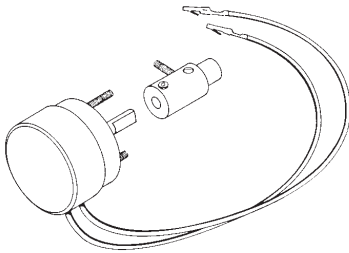

RPI Part #CAL082
 New OEM Part #42010110 & 42055811
 Old OEM Part #0101-606-000 & 0558-615-000

PILOT LIGHT

- Red
 - 125VAC, 1/3W
- Models: Dynac

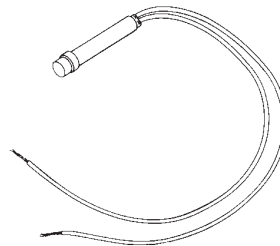

RPI Part #CAS043
 New OEM Part #42010105
 Old OEM Part #0101-602-000

BRAKE SWITCH

- DPDT
- Momentary
- 15A, 125VAC;
- 10A, 250VAC;
- 1/2HP, 250VAC

Fits: Control Panel
 Model: Dynac

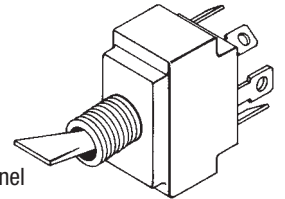

RPI Part #CAS063
 New OEM Part #42010306
 Old OEM Part #0103-602-001

POWER SWITCH

- SPDT
- 15A, 125VAC;
- 10A, 250VAC;
- 3/4HP, 125/250VAC

Fits: Control Panel
 Model: Dynac II

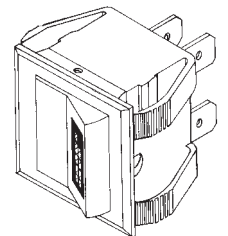

Orders placed before 2:00 P.M. (Pacific Time) will be shipped the same day.

RPI Part #CAS064
New OEM Part #42010307
Old OEM Part #0103-602-002

BRAKE SWITCH

- DPDT
- Momentary
- 15A, 125VAC;
- 10A, 250VAC

Fits: Control Panel
Model: Dynac II

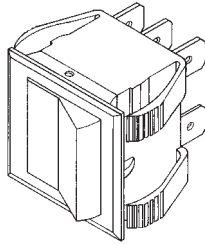

RPI Part #CAL004
New OEM Part #42010107
Old OEM Part #0101-604-001

LATCH SET

Fits: Cover Assembly
Models: Dynac & Dynac II

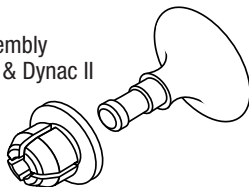

RPI Part #CAR095
New OEM Part #42010325
Old OEM Part #0103-621-100

K-2 RELAY

- 120V

Fits: Mounts to underside of control panel
Models: Dynac II

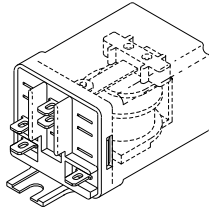

Model: QBC 4207

RPI Part #CAB005
New OEM Part #42010112
Old OEM Part #0101-608-000

RUBBER BUMPER

- 3 per package
 - Presses into lid
- Models: Dynac & Dynac II

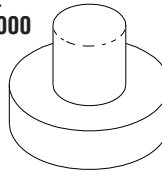

RPI Part #CAF056
New OEM Part #42010113
Old OEM Part #0101-609-000

RUBBER FOOT

- 4 per package
 - Steel washer molded in
 - Mounts to base plate
- Model: Dynac II

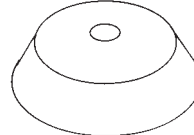

RPI Part #CAT093
New OEM Part #42010324
Old OEM Part #0103-620-100

STEPDOWN TRANSFORMER

- 120V step down to 24V
 - Mounts to underside of control panel
- Model: Dynac II

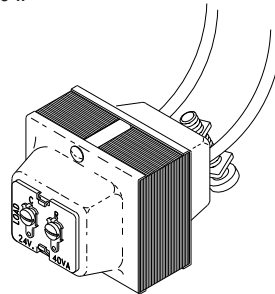

RPI Part #CAF013
New OEM Part #42010113
Old OEM Part #0101-609-000

RUBBER FOOT

- 3 per package
 - Steel washer molded in
 - Mounts to base plate
- Model: Dynac

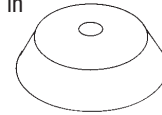

RPI Part #CAC015
New OEM Part #42054109
Old OEM Part #0541-603-000

POWER CORD

- 18/3 SJT, 15A, 125V
 - Length: 8 ft.
- Models: Dynac & Dynac II

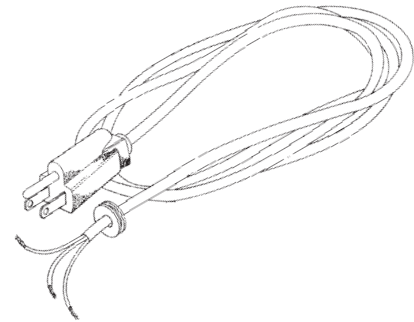

RPI Part #CAB021
New OEM Part #42059102
Old OEM Part #0591-600-001

BRUSH

- 2 per package
- Size: 3/16 x 3/16 x 5/8
- Radius: 3/4"
- Spring Length: 5/8"

Fits: Brush Holder Assembly
Models: QBC 4207 with "Jones" motor (Serial #185000 and above)

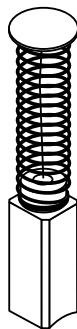

RPI Part #CAB022
New OEM Part #42059126
Old OEM Part #0591-640-001

BRUSH

- 2 per package
- Size: 1/4 x 1/4 x 1/2
- Radius: 5/8"
- Spring Length: 3/4"

Fits: Brush Holder Assembly
Model: QBC 4207 (Serial #184999 and below)



RPI Part #CAC015
New OEM Part #42054109
Old OEM Part #0541-603-000

POWER CORD

- 18/3 SJT, 15A, 125V
 - Length: 8 ft.
- Models: QBC 4207

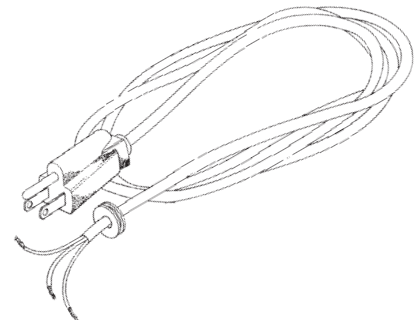

Unsurpassed quality is an RPI tradition.

Call Us Toll-Free Monday–Friday, 8:00 AM–4:30 PM (Pacific Time), (800) 221-9723

Centrifuges

Models: Readacrit & MP Readacrit

RPI Part #CAM024
New OEM Part #42059101
Old OEM Part #0591-600-000

MOTOR

- Motor is manufactured with bearings in place of oilite bushings
- 120VAC, 60 Hz., 8000 RPM ± 10%

Fits: Readacrit & MP Readacrit

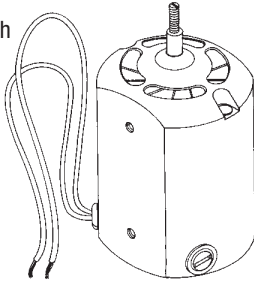

RPI Part #RPC039
BRUSH CAP WITH INSERT

- 6 per package
- 3/8-24 thread
- Fits:** Motor (RPI Part #CAM024)
- Models:** Readacrit & MP Readacrit

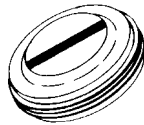

RPI Part #CAB021
New OEM Part #42059102
Old OEM Part #0591-600-001

BRUSH

- 2 per package
- Size: 3/16 x 3/16 x 5/8
- Radius: 3/4"
- Spring Length: 5/8"

Fits: Brush Holder Assembly
Models: Readacrit (Early model motor with slots top and bottom)

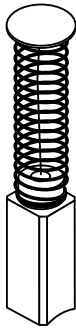

RPI Part #CAB022
New OEM Part #42059126
Old OEM Part #0591-640-001

BRUSH

- 2 per package
- Size: 1/4 x 1/4 x 1/2
- Radius: 5/8"
- Spring Length: 3/4"

Fits: Brush Holder Assembly
Model: Readacrit (Early model motor without slots top and bottom)

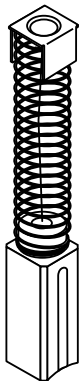

RPI Part #CAT045
New OEM Part #42059202
Old OEM Part #0592-601-000

MECHANICAL TIME SWITCH (5 minute)

- SPST
- 15A, 120-240VAC; 1/3HP, 120-240VAC
- Includes timer with switch, knob, and (4) screw

Fits: Front Panel or Conversion Kit
Models: Readacrit & MP Readacrit

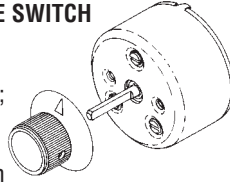

RPI Part #CAS040
New OEM Part #42059105
Old OEM Part #0591-602-000

SAFETY SWITCH ASSEMBLY

- SPDT
- 3A, 125VAC; 1A, 250VAC
- Mounts opposite ball catch assembly
- Includes switch, and insulator

Models: Readacrit & MP Readacrit (Old Style)

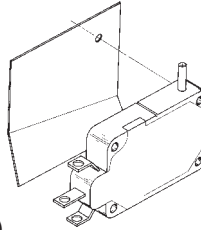

RPI Part #CAC006
New OEM Part #42059112
Old OEM Part #0591-605-000

BALL CATCH ASSEMBLY

- Mounts to exterior of body on units using old style latch assembly (OEM Part #0591-604-001)

Models: Readacrit & MP Readacrit

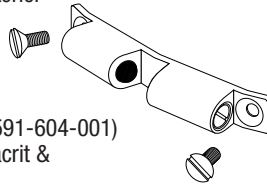

RPI Part #CAS041
New OEM Part #42059106
Old OEM Part #0591-602-101

SAFETY SWITCH ASSEMBLY

- SPST
- 10.1A, 125VAC; 1/4HP, 125VAC
- Mounts inside catch block
- Includes insulator, and stripped leads

Fits: New Style Catch Block and Latch
Models: Readacrit & MP Readacrit

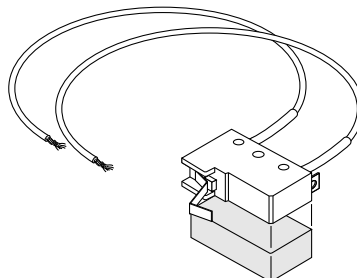

RPI Part #CAB076
New OEM Part #42059125
Old OEM Part #0591-622-100

CATCH BLOCK

- Mounts to exterior of body
- Models:** Readacrit & MP Readacrit

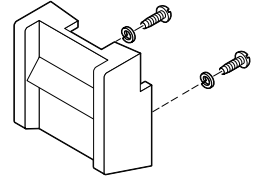

RPI Part #CAL077
New OEM Part #42059111
Old OEM Part #0591-604-101

LATCH ASSEMBLY

- Mounts on lid
- Models:** Readacrit & MP Readacrit

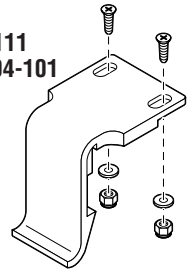

RPI Part #CAC086
New OEM Part #42059128
Old OEM Part #0591-604-100

LID COVER ASSEMBLY

- Includes Lid, Latch Assembly (RPI Part #CAL077) & Hinge Block
 - Mounts on centrifuge body
- Fits:** Guard
Models: Readacrit & MP Readacrit

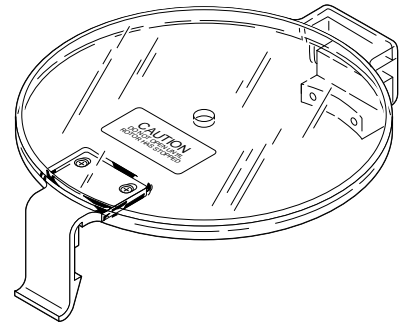

RPI Part #CAA073
New OEM Part #42059116
Old OEM Part #0591-609-000

HEAD ASSEMBLY

- When replacing this part, it is also a good time to replace the Rubber Cushion (RPI Part #CAC028)

Fits: Pressed on Shaft of Motor
Models: Readacrit & MP Readacrit

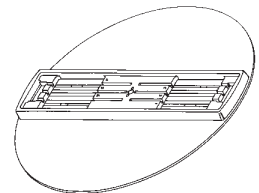

RPI Part #CAG007
New OEM Part #42059113
Old OEM Part #0591-606-000

GULLWING ASSEMBLY

- Includes gullwing, nylon washer, spring washer, knob and top section of locking cam
- When replacing this part, it is also a good time to replace the Rubber Cushion (RPI Part #CAC028)

Fits: Head Assembly
Models: Readacrit & MP Readacrit

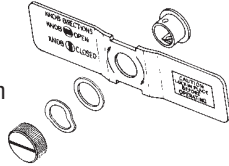

RPI Part #CAH008
New OEM Part #42059115
Old OEM Part #0591-608-000

HARDWARE ONLY / GULLWING

Fits: Gullwing Assembly and Motor Spindle
Models: Readacrit & MP Readacrit

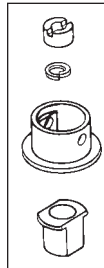

RPI Part #CAC028
New OEM Part #42059123
Old OEM Part #0591-617-000

RUBBER CUSHION

- 12 per package
- Fits:** Head Assembly
Models: Readacrit & MP Readacrit

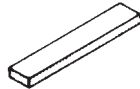

RPI Part #CAC029
New OEM Part #42059118
Old OEM Part #0591-611-000

RUBBER CHANNEL

Fits: Rim of Centrifuge Body under Lid Assembly
Models: Readacrit & MP Readacrit



CAC029
 CROSS SECTION

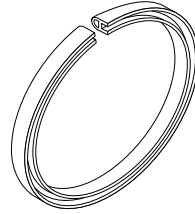

RPI Part #CAC055
OEM Part # N/A

RUBBER CUSHION

- 12 per package
- Fits:** Head Assembly
Models: Readacrit & MP Readacrit using Safe Tec® Non-Spill Tubes only

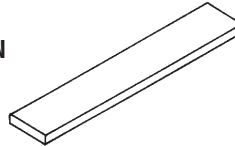

RPI Part #CAG081
New OEM Part #42059121
Old OEM Part #0591-615-000

RUBBER GROMMET

- 3 per package
- Fits:** Bottom Plate
Models: Readacrit & MP Readacrit

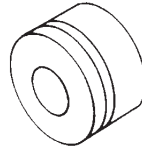

RPI Part #CAF012
New OEM Part #42059119
Old OEM Part #0591-613-000

SUCTION CUP FOOT

- 3 per package
 - Old style foot
 - 8-32 x 1/4 stud
 - Mounts to base plate
- Models:** Readacrit & MP Readacrit

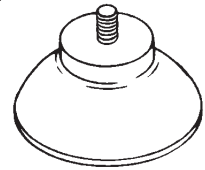

RPI Part #CAC015
New OEM Part #42054109
Old OEM Part #0541-603-000

POWER CORD

- 18/3 SJT, 15A, 125V
 - Length: 8 ft.
- Models:** Readacrit & MP Readacrit

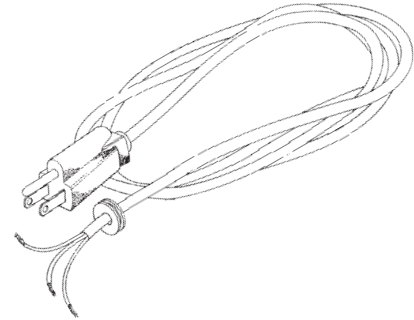

Models: Safeguard & Safety Head

RPI Part #CAB018
New OEM Part #42000102
Old OEM Part #0001-600-001

BRUSH

- 2 per package
 - Size: 1/4 x 1/4 x 3/4
 - Radius: 1.0"
 - Spring Length: 7/8"
- Fits:** Brush Holder Assembly
Models: Safeguard & Safety-Head

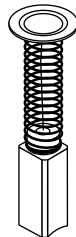

RPI Part #CAB020
OEM Part # N/A

BRUSH

- 2 per package
 - Size: 1/4 x 1/4 x 3/4
 - Radius: 3/4"
 - Spring Length: 1.0"
- Fits:** Brush Holders with External Brush Caps
Models: Older Safeguards & Safety-Heads

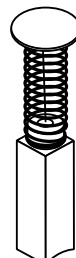

RPI Part #CAF010
New OEM Part #42000106
Old OEM Part #0001-609-000

SUCTION CUP FOOT

- 3 per package
 - 8-32 x 3/8 stud
 - Mounts to base plate
- Models:** Safeguard & Safety-Head

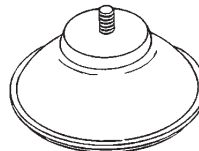

RPI Part #CAC015
New OEM Part #42054109
Old OEM Part #0541-603-000

POWER CORD

- 18/3 SJT, 15A, 125V
 - Length: 8 ft.
- Models:** Safeguard & Safety-Head

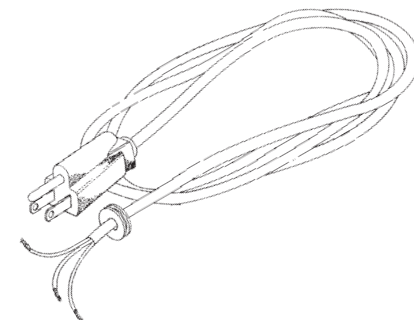

Cross section illustrations are actual size. Where practical, cut old part to match with cross section illustration.

Centrifuges

Models: Sero-Fuge & Sero-Fuge II

RPI Part #CAL077
New OEM Part #42059111
Old OEM Part #0591-604-101

LATCH ASSEMBLY

- Mounts on lid
- Models:** Sero-Fuge & Sero-Fuge II

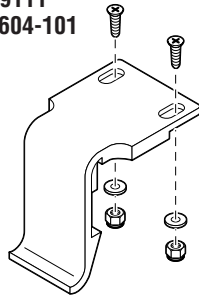

RPI Part #CAC087
OEM Part #0541-604-000

LID COVER ASSEMBLY

- Includes lid, latch assembly (RPI Part #CAL077) and hinge block
- Fits:** Guard
- Models:** Sero-Fuge & Sero-Fuge II

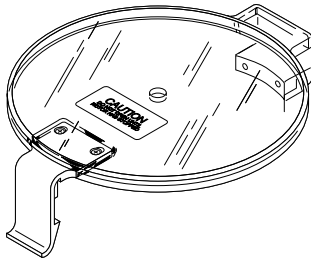

RPI Part #CAS041
New OEM Part #42059106
Old OEM Part #0591-602-101

SAFETY SWITCH ASSEMBLY

- SPST
- 10.1A, 125VAC; 1/4HP, 125VAC
- Mounts inside catch block
- Includes insulator, and stripped leads
- Fits:** New Style Catch Block and Latch
- Models:** Sero-Fuge II

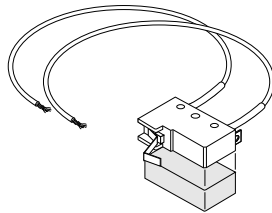

RPI Part #CAS069
New OEM Part #42052102
Old OEM Part #0521-602-000

HOLD SWITCH

- DPDT
- 3A, 125VAC; 1A, 250VAC
- Fits:** Control Panel
- Model:** Sero-Fuge

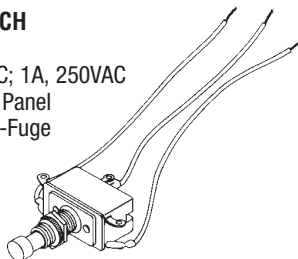

RPI Part #CAT071
New OEM Part #42054105
Old OEM Part #0541-601-000

TIMER

- 5 minute timer
- Includes knob (RPI Part #CAK111)
- 120VAC, 60Hz, 20 AMP rating
- Accurate to ±2% full scale
- 3/16 shaft
- Fits:** Front Panel
- Model:** Sero-Fuge II Only

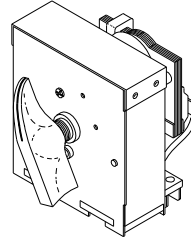

RPI Part #CAT067
New OEM Part #42052101
Old OEM Part #0521-601-000

ELECTRIC TIME SWITCH

- 5 minute
- SPST
- 15A, 120–250VAC; 1/2HP, 120–250VAC
- Fits:** Control Panel
- Model:** Sero-Fuge

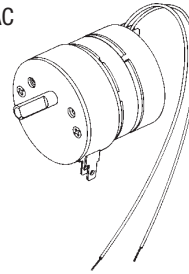

RPI Part #CAM101
New OEM Part #42054101
Old OEM Part #0541-600-000

MOTOR (115V)

- 115V/60Hz.
- Shaded pole
- -1.8 AMP current draw
- Two speeds: 3000 RPM @ "HIGH" and 2400 RPM @ "LOW"
- Fits:** Mounting holes under guard bowl
- Model:** Sero-Fuge II

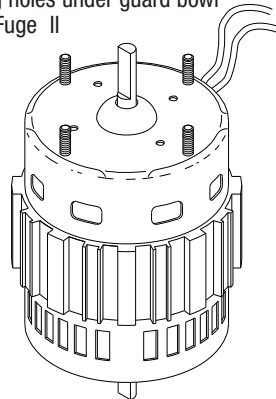

RPI Part #CAB083
New OEM Part #42054129
Old OEM Part #0541-613-000

REPLACEMENT BRUSH

- 2 per package
- Fits:** Governor brush carrier
- Model:** Sero-Fuge II



RPI Part #CAK111
New OEM Part #42054106
Old OEM Part #0541-601-001

TIMER KNOB

- Fits Sero-Fuge II timer with 3/16 round shaft
- Fits:** Timer shaft
- Model:** Sero-Fuge II Only

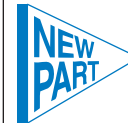

RPI Part #CAG091
New OEM Part #42054103
Old OEM Part #0541-600-005

GOVERNOR ASSEMBLY

- Mounts to bottom shaft of motor
- Fits:** Motor Base
- Model:** Sero-Fuge II

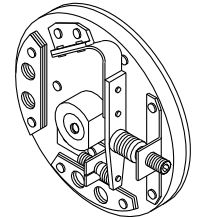

RPI Part #CAC089
New OEM Part #42054102
Old OEM Part #0541-600-004

BRUSH CARRIER

- Includes (2) brushes (RPI Part #CAB083)
- Fits:** Motor Base
- Model:** Sero-Fuge II

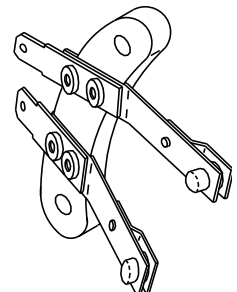

RPI Part #CAC098
 New OEM Part #42053103
 Old OEM Part #0531-600-003

CAPACITOR
 • .68 MFD, 400V
Fits: Braking Resistor Assembly
Models: Sero-Fuge II

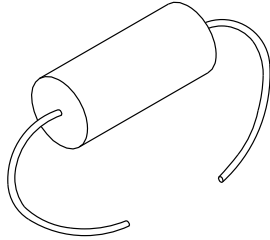

RPI Part #CAR096
 New OEM Part #42053102
 Old OEM Part #0531-600-002

VOLTAGE RECTIFIER
 • Industry Standard No. IN4004
Fits: Braking resistor assembly
Models: Sero-Fuge II

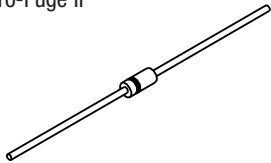

RPI Part #CAR097
 New OEM Part #42053101
 Old OEM Part #0531-600-001

BRAKING RESISTOR
 • Wirewound fixed power
 • 150 OHM, 50W
Fits: Braking resistor assembly
Models: Sero-Fuge II

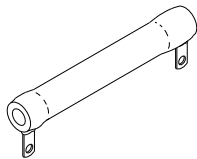

RPI Part #CAC036
 New OEM Part #42052104
 Old OEM Part #0521-608-001

RUBBER CHANNEL
 • Mounts on guard assembly
 under lid assembly
Models: Sero-Fuge
 & Sero-Fuge II



RPI Part #CAS090
 New OEM Part #42054121
 Old OEM Part #0541-614-100

BASE-RUBBER SEAL (NEW STYLE)
 • Includes base-rubber seal and
 (6) stato seals
Fits: Bottom of guard
Model: Sero-Fuge II

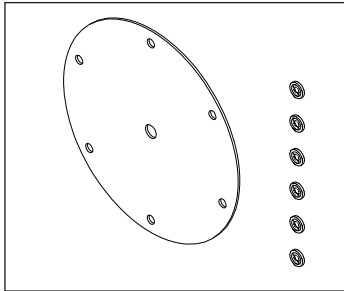

RPI Part #CAS068
 New OEM Part #42054107
 Old OEM Part #0541-602-000

BRAKE SWITCH
 • DPDT
 • Momentary
 • 6A, 125VAC; 3A, 250VAC
Fits: Control Panel
Model: Sero-Fuge II

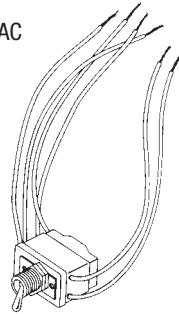

RPI Part #CAL092
 New OEM Part #42052601
 Old OEM Part #0526-609-000

RUBBER STRIP LINER - 6 PLACE HEAD
Fits: Head assembly
Model: Sero-Fuge

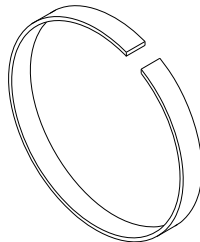

Cross section illustrations are actual size. Where practical, cut old part to match with cross section illustration.

RPI Part #CAC015
 New OEM Part #42054109
 Old OEM Part #0541-603-000

POWER CORD
 • 18/3 SJT, 15A, 125V
 • Length: 8 ft.
Model: Sero-Fuge
 & Sero-Fuge II

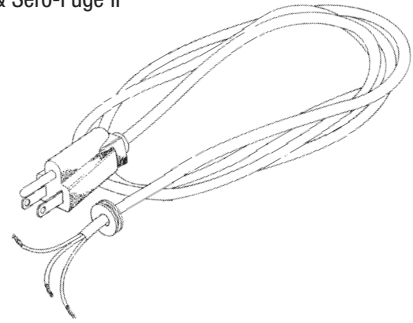

RPI Part #CAS070
 New OEM Part #42054119
 Old OEM Part #0541-611-000

HI-LOW SWITCH
 • SPST
 • 6A, 125VAC;
 3A, 250VAC
Fits: Control Panel
Model: Sero-Fuge II



RPI Part #CAF109
 New OEM Part #4254116
 Old OEM Part #0541-608-000

FOOT KIT WITH HARDWARE
 • Includes all mounting hardware: 4
 of each part per package
 • 60 shore black rubber
Fits: Bottom plate
Model: Sero-Fuge & Sero-Fuge II

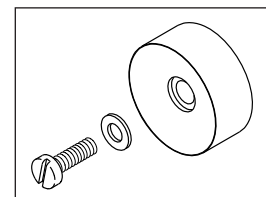

Visit the RPI website
www.rpiparts.com

Centrifuges

Model: Triac

RPI Part #CAM025
 New OEM Part #42020001
 Old OEM Part #0200-600-000

MOTOR ASSEMBLY

- 120VAC, 60 Hz., 10,300 RPM max.
- Includes motor, collar, and pin
- When replacing this motor, it is also a good time to replace the Motor Gasket (RPI Part #CAG034)

Model: Triac (Serial #144999 and below)

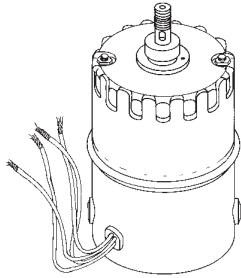

RPI Part #RPC037

BRUSH CAP WITH INSERT

- 6 per package
- 3/8-24 thread

Fits: Motor (RPI Part #CAM025)

Models: Triac (Serial #144999 and below)



RPI Part #CAM027
 New OEM Part #42021001
 Old OEM Part #0210-600-000

MOTOR ASSEMBLY

- 120VAC, 60 HZ., 10,300 RPM max.
- Includes motor, collar, pin, and reductor gear
- When replacing this motor, it is also a good time to replace the Motor Gasket (RPI Part #CAG034)

Model: Triac (Serial #145000 and above)

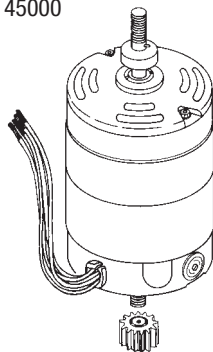

RPI Part #RPC036

BRUSH CAP WITH INSERT

- 6 per package
- 3/8-24 thread

Fits: Motor (RPI Part #CAM027)

Models: Triac (Serial #145000 and above)



RPI Part #CAG034
 New OEM Part #42020003
 Old OEM Part #0200-600-050

MOTOR GASKET

Fits: Thru Hole in Centrifuge Body

Model: Triac

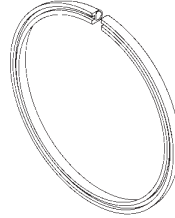

Cross section illustrations are actual size. Where practical, cut old part to match with cross section illustration.

RPI Part #CAB018
 New OEM Part #42000102
 Old OEM Part #0001-600-001

BRUSH

- 2 per package
- Size: 1/4 x 1/4 x 3/4
- Radius: 1.0"
- Spring Length: 7/8"

Fits: Brush Holder Assembly

Model: Triac

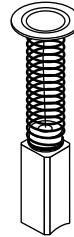

RPI Part #CAG035
 New OEM Part #42020008
 Old OEM Part #0200-604-001

COVER GASKET

Fits: Groove in Centrifuge Body

Model: Triac

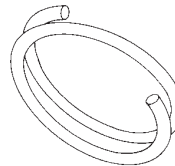

RPI Part #CAF011
 New OEM Part #42020013
 Old OEM Part #0200-608-

RUBBER FOOT

- 4 per package
- Steel washer molded in
- Mounts to base plate

Model: Triac (Serial #144999 and below)



RPI Part #CAC030
 New OEM Part #42020017
 Old OEM Part #0200-617-000

GASKET (MCHT TUBE)

- 8 per package
- Fits: Head Assembly

Model: Triac

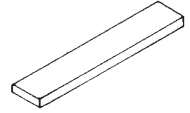

RPI Part #CAC031
 New OEM Part #42020015
 Old OEM Part #0200-610-000

TRUNNION CUSHION

- 8 per package
- Fits: Trunnion

Model: Triac



RPI Part #CAT066
 New OEM Part #42020004
 Old OEM Part #0200-601-000

ELECTRIC TIME SWITCH (15 minute)

- SPDT
- 15A, 120-250VAC
- Body of RPI timer is slightly larger than OEM's; Inner dial on OEM timer rotates to indicate time-Outer dial on RPI timer rotates to indicate time; Rewire per RPI instructions (included)
- Includes timer, and face plate

Fits: Control Panel

Model: Triac

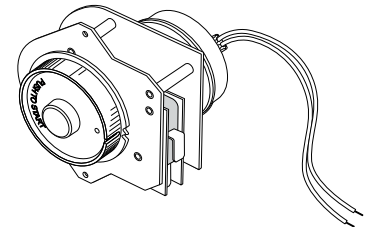

RPI Part #CAC015
 New OEM Part #42054109
 Old OEM Part #0541-603-000

POWER CORD

- 18/3 SJT, 15A, 125V
- Length: 8 ft.

Model: Triac

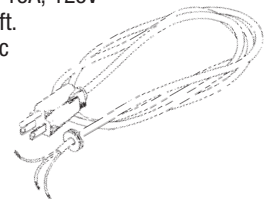

RPI Part #CAM102
New OEM Part #42022501
Old OEM Part #0226-600-001

MOTOR ASSEMBLY

- 120VAC, 1.5 AMP, 60Hz.
(Working range 110-130 VAC)
 - 3200 RPM +400 -140 RPM
- Fits:** Base plate
Models: Compact II

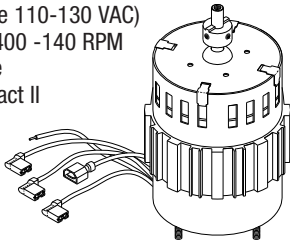

RPI Part #AIC058
OEM Part #42022506

MOTOR START CAPACITOR

- 6.0 Microfarad
 - Matchbox style
- Fits:** Base plate
Models: Compact II

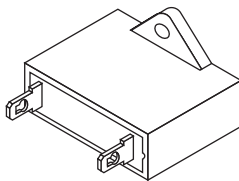

RPI Part #CAC110
New OEM Part #42022507
Old OEM Part #0225-601-030

WIRE CLAMPS

- 3 per package
 - Nylon®
 - Wire clamps are re-useable
- Fits:** Base plate
Model: Compact II

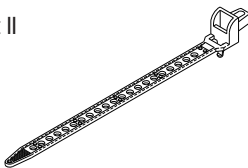

RPI Part #CAS106
New OEM Part #42022508
Old OEM Part #0225-603-000

SAFETY SWITCH

- Switch: 125/250VAC, 10.1 AMP
 - Includes switch, wire and insulated connectors
- Fits:** Under rear of lid
Model: Compact II

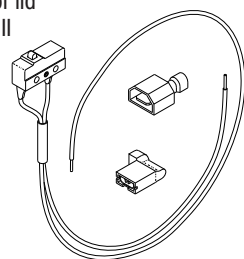

RPI Part #CAT104
New OEM Part #42022505
Old OEM Part #0225-601-013

MECHANICAL TIME SWITCH

- 30 minute with bell and knob
 - SPDT
 - 120VAC, 15 AMP
 - ±5% accuracy
 - Two-hole mount with manual override hold position
- Fits:** Front panel of centrifuge
Model: Compact II

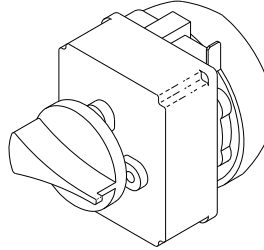

RPI Part #CAS103
New OEM Part #42015103
Old OEM Part #0151-607-000

HEAD SCREW ASSEMBLY

- Aluminum
 - Includes finger washer and retaining ring
- Fits:** Shaft of motor
Model: Analytical & Compact II

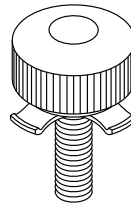

RPI Part #CAD108
New OEM Part #42015102
Old OEM Part #0151-600-010

MOTOR DRIVE ASSEMBLY

- Brass
 - Includes motor drive and (2) set screws (RPI Part #RPH201)
- Fits:** Motor Shaft
Models: Analytical, Compact II & Physician's Compact

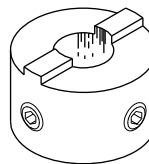

RPI Part #CAS042
New OEM Part #42012302
Old OEM Part #0123-602-000

ON/OFF SWITCH ASSEMBLY

- Replaces new style switch only
 - SPDT
 - 3A, 125VAC; 1A, 250VAC
- Fits:** Control Panel
Models: Analytical, Physician's Compact, Physician's Jr. & Yankee Rotator

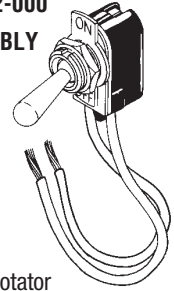

RPI Part #CAB023
OEM Part #0121-600-001

BRUSH

- 2 per package
 - Size: 3/16 x 3/16 x 5/8
 - Spring Length: 1-1/4"
- Fits:** Brush Holder Assembly
Model: Physician's Junior

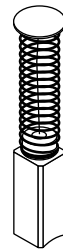

RPI Part #CAF010
New OEM Part #42000106
Old OEM Part #0001-609-000

SUCTION CUP FOOT

- 3 per package
 - 8-32 x 3/8 stud
 - Mounts to base plate
- Models:** Analytical, Physician's Compact & Physician's Jr

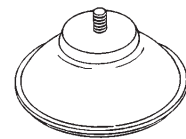

RPI Part #CAC015
New OEM Part #42054109
Old OEM Part #0541-603-000

POWER CORD

- 18/3 SJT, 15A, 125V
 - Length: 8 ft.
- Models:** Analytical, Cyclomixer, Physician's Compact, Physician's Jr., Yankee Pipette Shaker & Yankee Rotator

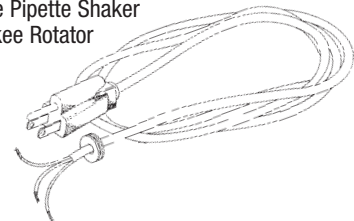

Place Your Order
24x7 via E-Mail
order@rpiparts.com

**RPI Part #DRB001
OEM Part #7735023**

BRUSH

- 2 per package
- Size: 1/4 x 3/8 x 15/16
- Radius: 5/8"
- Spring length: 1-1/4"
- Copper shunt wire

Fits: Brush Holder Assembly
Models: L-708 & L-711

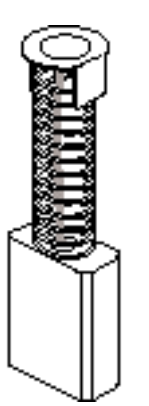

All of our parts are in stock and available for immediate shipment.

NOTES:

Centrifuges

Models: 3200, 5402, 5412, 5413, 5414, 5415 & 5415C

RPI Part #EPB001
OEM Part #22-36-524-0

- BRUSH**
- 2 per package
 - Size: .250 x .312 x .940
 - Radius: 1/2"
 - Spring length: 1.430"
- Fits:** Brush Holder Assembly
Model: 5415 (Serial #3716 and below)



RPI Part #EPB002
OEM Part #22-36-527-4

- BRUSH**
- 2 per package
 - Size: .250 x .312 x .860
 - Radius: 1/2"
 - Spring length: 1.430"
- Fits:** Brush Holder Assembly
Model: 5415 (Serial #3717 and above), 5415C & 5402

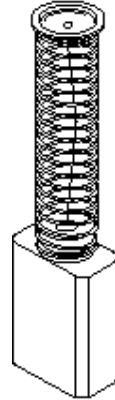

RPI Part #EPB003
OEM Part #22-36-521-5

- BRUSH**
- 2 per package
 - Size: .250 x .312 x .715
 - Radius: 1/2"
 - Spring length: 1.130"
- Fits:** Brush Holder Assembly
Models: 3200 & 5414

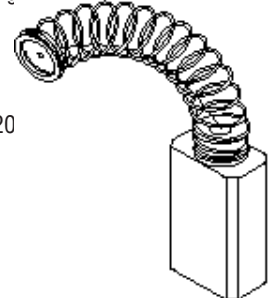

NOTES: _____

RPI Part #HBC003
OEM Part #V6105

CAPACITOR

- 4 MFD, 370VAC
- Matchbox style
- Fits:** Bottom mounting plate
- Models:** VanGuard V-6000 & V-6500

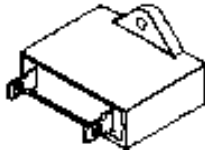

RPI Part #HBL004
OEM Part #V6145

INDICATOR LAMP

- Lamp rated @ 125VAC
- Fits:** Front panel cut-out
- Models:** VanGuard V-6500

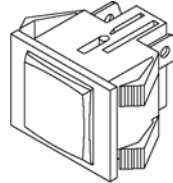

RPI Part #HBM011
OEM Part #V6125

POWER MODULE

- 125/250VAC, 15 AMP
- Fits:** Cut-out in rear chassis panel
- Models:** VanGuard V-6000 & V-6500

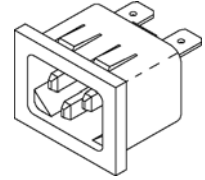

RPI Part #HBF010
OEM Part #V6135

SUCTION CUP FOOT

- 4 per package
- 1-3/4 cup with 8-32 x 3/8 stud
- Fits:** Mounting holes in base of chassis plate
- Models:** VanGuard V-6000 & V-6500



RPI Part #HBM001
OEM Part #V6100

MOTOR

- 115VAC, 60Hz, .67 AMP
- 3400 RPM, .05HP
- Includes motor mounts and clamping knob with tach pickup label
- Fits:** Mounting holes in base of centrifuge
- Models:** VanGuard V-6000 & V-6500

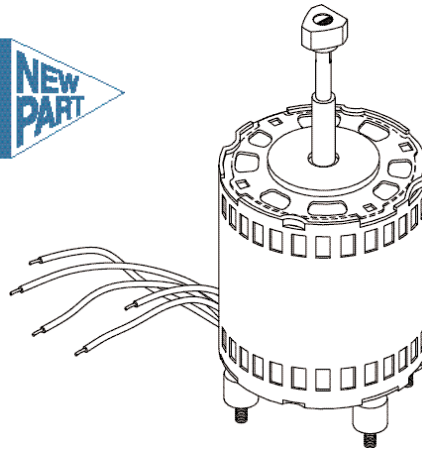

RPI Part #HBS006
OEM Part #V6130

LID SAFETY SWITCH

- 125/250VAC, 10 AMP
- Fits:** Mounting holes in rear panel
- Models:** VanGuard V-6000 & V-6500

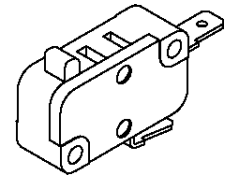

RPI Part #HBK007
OEM Part #V6115

CLAMPING KNOB

- 1/4-20 thread
- Includes tachometer pick-up label
- Fits:** External threads of motor shaft
- Models:** VanGuard V-6000 & V-6500



RPI Part #HBT002
OEM Part #V6070

MECHANICAL TIME SWITCH

- 60 minute with bell and knob
- SPDT
- 120VAC, 14 AMP
- ±5% accuracy
- Fits:** Front mounting plate
- Model:** VanGuard

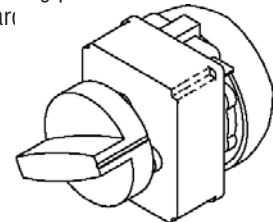

RPI Part #HBK008
OEM Part #V6175

TIMER KNOB

- Fits 1/4 diameter shaft with a flat
- Fits:** Timer shaft
- Models:** VanGuard V-6500



RPI Part #HBM009
OEM Part #V6150

MOTOR MOUNT

- 4 per package
- Black rubber
- 8-32 internal and external threads
- Fits:** Mounting studs on bottom of motor
- Models:** VanGuard V-6000 & V-6500

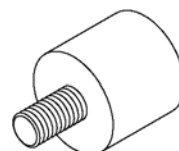

RPI Part #RPC262

POWER CORD

- 10 feet
- Plug NEMA 5-15
- Connector IEC320 C-13
- Cord rated @ 15 AMP
- Specifically for equipment with IEC320 C-14 power inlet modules

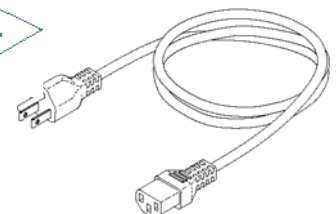

New RPI Part #IEM025
Old RPI Part #DAM025
OEM Part #1875

MOTOR ASSEMBLY

- 115 VAC, 50/60 cycles
- Minimum Speed: 11,500 RPM
- Includes Head Adapter Assembly (RPI Part #IEA001)
- When replacing this part, it is also a good time to replace the Motor Shock Mount Assembly (RPI Part #IES020)

Model: MB Micro-Hematocrit

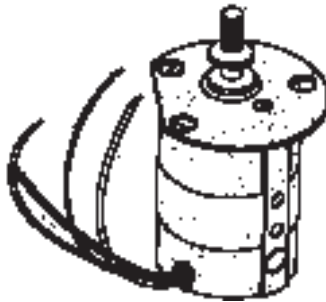

RPI Part #RPC037

BRUSH CAP WITH INSERT

- 6 per package
- 3/8-24 thread
- Fits:** Motor (RPI Part #IEM025)
- Models:** MB Micro-Hematocrit



New RPI Part #IEB008
Old RPI Part #DAB008
OEM Part #1840

BRUSH

- 2 per package
- Size: 7/32 x 5/16 x 5/8"
- Radius: 3/8"
- Spring length: 1.0"
- Copper shunt wire
- Fits:** Brush Holder Assembly
- Model:** MB Micro-Hematocrit



New RPI Part #IEB024
Old RPI Part #DAB024
OEM Part # N/A

BRUSH

- 2 per package
- Size: 1/4 x 1/4 x 21/32"
- Radius: .725"
- Spring length: 1.0"
- Copper shunt wire
- Fits:** Motor (RPI Part #CAM049, CAM050 & IEM025) only
- Model:** MB Micro-Hematocrit



New RPI Part #IEF022
Old RPI Part #DAF022
OEM Part #1884

FOOT

- 4 per package
- Fits:** Bottom Plate
- Model:** MB Micro-Hematocrit

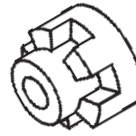

New RPI Part #IEA001
Old RPI Part #DAA001
OEM Part #7915B

HEAD ADAPTER ASSEMBLY

- Includes head adapter, (2) 10-32 x 1/8 stainless steel set screw, and (2) stainless steel pin
- Fits:** Shaft of Motor
- Model:** MB Micro-Hematocrit

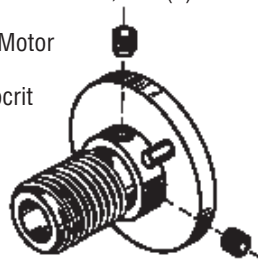

New RPI Part #IEK006
Old RPI Part #DAK006
OEM Part # N/A

HEAD ADAPTER KIT

- Includes head adapter, head cover nut, nylon® washer, head adapter nut, and retainer ring
- Fits:** Shaft of Motor
- Model:** MB Micro-Hematocrit

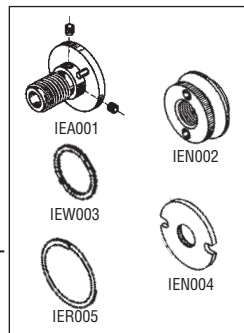

New RPI Part #IEC016
Old RPI Part #DAC016
OEM Part #1505

RUBBER CUSHION

- Size: 3/16 x 1/16 x 25"
- Fits:** Rotor Head
- Model:** MB Micro-Hematocrit

IEC016
 CROSS SECTION

New RPI Part #IES020
Old RPI Part #DAS020
OEM Part #30882, 30888 & 30992

MOTOR SHOCK MOUNT ASSEMBLY

- 3 per package
- Includes (3) rubber isolator, (3) sleeve, and (6) washer
- Fits:** Motor Mounts of Drive Motor
- Model:** MB Micro-Hematocrit

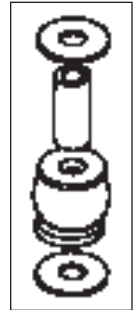

New RPI Part #IEN002
Old RPI Part #DAN002
OEM Part #7913

HEAD COVER NUT

- Fits:** Head Adapter
- Model:** MB Micro-Hematocrit



New RPI Part #IEN004
Old RPI Part #DAN004
OEM Part #7915B

HEAD ADAPTER NUT

- Fits:** Head Adapter
- Model:** MB Micro-Hematocrit



New RPI Part #IER005
Old RPI Part #DAR005
OEM Part #30012

RETAINER RING

- Fits:** Head Adapter
- Model:** MB Micro-Hematocrit

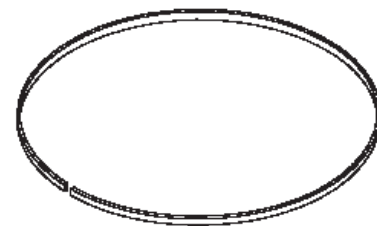

Cross section illustrations are actual size. Where practical, cut old part to match with cross section illustration.

Centrifuges

Models: MB Micro-Hematocrit (continued)

New RPI Part #IES021
Old RPI Part #DAS021
OEM Part #9942

SAFETY SWITCH

- SPDT
- 20A, 125V, 250V, 450VAC;
- 25A, 250VDC; 50A, 125VDC

Model: MB Micro-Hematocrit

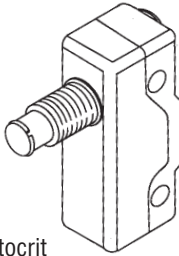

New RPI Part #IES026
Old RPI Part #DAS026
OEM Part # N/A

BRAKE SWITCH

- SPDT
- 10A, 125VAC-DC;
- 1/4 HP, 125VAC-DC

Model: MB Micro-Hematocrit

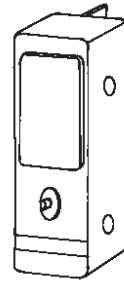

New RPI Part #IEW003
Old RPI Part #DAW003
OEM Part #30897

NYLON® WASHER

- Fits: Head Adapter

Model: MB Micro-Hematocrit



New RPI Part #IES023
Old RPI Part #DAS023
OEM Part #1880

BRAKE SWITCH ASSEMBLY

- DPDT
- 10A, 125VAC-DC;
- 1/4 HP, 125VAC-DC

Model: MB Micro-Hematocrit

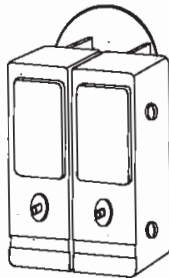

New RPI Part #IET019
Old RPI Part #DAT019
OEM Part #768

MECHANICAL TIME SWITCH (15 minute)

- SPST
- Switch: 20A, 120-240VAC
- Includes time switch, mounting hardware, and knob

Model: MB Micro-Hematocrit

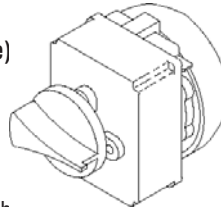

Visit the RPI website:
www.rpiparts.com

Model: Spinette

New RPI Part #IEB040
OEM Part #45985

CATCH BRACKET ASSEMBLY

- Includes hardware and mounting plate

Fits: Mounting holes in lid

Model: Spinette

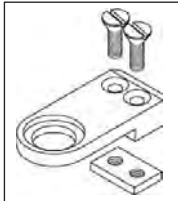

New RPI Part #IEP039
OEM Part #49658

SPRING LOADED PLUNGER

Fits: Mounting holes in catch bracket

Model: Spinette



New RPI Part #IES045
OEM Part #46611

ROCKER POWER SWITCH

- SPST
- 115VAC, 16 AMP

Fits: Front panel cut-out

Model: Spinette



New RPI Part #IEM044
OEM Part #46620

MOTOR

- 1/30 horsepower
- 120VAC ±10%; 60Hz.
- -1.5 AMP current draw
- 3400 RPM ±200 RPM

Fits: Mounting holes in bottom mounting plate

Model: Spinette

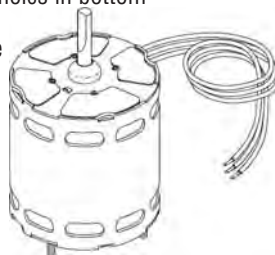

New RPI Part #IEP046
OEM Part #46647

VENT PLATE

- 18 gage perforated stainless steel
- Includes hardware

Fits: Mounting studs in base plate

Model: Spinette

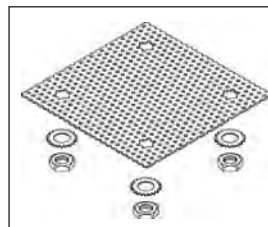

New RPI Part #IEC042
OEM Part #46621

POWER CORD

- 6 feet long
- Includes strain relief bushing
- 13 AMP

Fits: Mounting holes at bottom rear of centrifuge

Model: Spinette

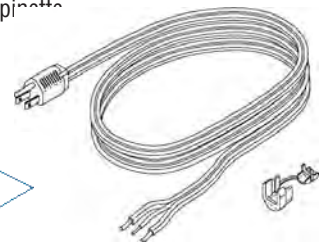

Models: B20A, Centra-7, Centra-7R, CH, CL, CM, CRU5000, CS, CU5000, DPR6000, H, HN, HNS, HNSII, HT, K Size 2, PR-J, PR-6, PR-6000 & UV

New RPI Part #IEB007
Old RPI Part #DAB007
OEM Part #1780

BRUSH

- 2 per package
- Size: 1/4 x 1/4 x 7/8"
- Radius: 1.0"
- Spring length: 2.0"
- No shunt wire

Fits: Brush Holder Assembly
Models: CH, CL, H, HN, HNS & HNSII



New RPI Part #IEB011
Old RPI Part #DAB011
OEM Part #40069

BRUSH

- 2 per package
- Size: 1/4 x 5/8 x 1-1/8"
- Radius: 1.0"
- Spring length: 1-1/2"
- Copper shunt wire

Fits: Brush Holder Assembly
Models: PR-J & PR-6



New RPI Part #IEM017
Old RPI Part #DAM017
OEM Part #7488

MOTOR MOUNT

Fits: Mounting Plate of Motor
Model: UV

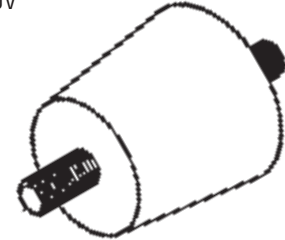

New RPI Part #IEB009
Old RPI Part #DAB009
OEM Part #1913

BRUSH

- 2 per package
- Size: 1/4 x 5/8 x 1-1/8"
- Radius: 1.0"
- Spring length: 1-3/8"
- Copper shunt wire

Fits: Brush Holder Assembly
Model: K Size 2



New RPI Part #IEB012
Old RPI Part #DAB012
OEM Part #48264

BRUSH

- 2 per package
- Size: 1/4 x 1-1/4 x 1-1/4"
- Radius: 1-1/8"
- Bevel: 5°
- Spring length: 1-5/8"
- Copper shunt wire

Fits: Brush Holder Assembly
Models: CU5000, CRU5000, DPR6000, PR-6000 & Late Model B20A



New RPI Part #IET018
Old RPI Part #DAT018
OEM Part #761

MECHANICAL TIME SWITCH

(2 hour)

- DPDT
- Switch: 20A, 240VAC
- Includes time switch, mounting hardware, and knob

Models: CM, CS & HT

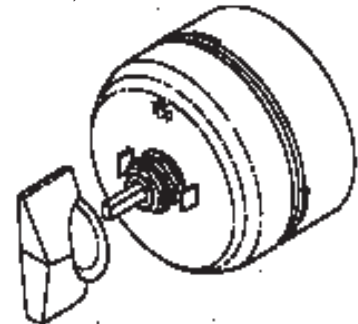

New RPI Part #IEB010
Old RPI Part #DAB010
OEM Part #1946

BRUSH

- 2 per package
- Size: 3/16 x 5/8 x 1-1/16"
- Radius: 5/8"
- Bevel: 5°
- Spring length: 1-1/8"
- Copper shunt wire

Fits: Brush Holder Assembly
Models: CS & UV



New RPI Part #IEB013
Old RPI Part #DAB013
OEM Part #47263

BRUSH

- 2 per package
- Size: 1/4 x 7/16 x 13/16"
- Radius: 1/2"
- Spring length: 1-1/8"
- Copper shunt wire
- Split brush

Fits: Brush Holder Assembly
Models: Centra-7 & 7R



New RPI Part #IEB015
Old RPI Part #DAB015
OEM Part #48192

BRUSH

- 2 per package
- Size: 3/16 x 3/8 x 1"
- Radius: 3/4"
- Spring length: 1-1/4"
- Copper shunt wire

Fits: Brush Holder Assembly
Models: Centra-7 & 7R



New RPI Part #IEB014
Old RPI Part #DAB014
OEM Part #47889

BRUSH

- 2 per package
- Size: 1/4 x 3/8 x 27/32"
- Radius: 1/2"
- Spring length: 1-1/4"
- Copper shunt wire

Fits: Brush Holder Assembly
Models: Centra-7 & 7R



RPI is the name you can trust for quality replacement parts.

Centrifuges

Models: GLC-1, GLC-2, GLC-2B, GLC-3, GLC-4, "Howard," RC-3, RC-3B, RC-3C, RC-2B, RC-5, RC-5B, RC-5C & RT-6000

**RPI Part #SRB001
OEM Part #12293**

BRUSH

- 2 per package
- Size: 1/4 x 1/2 x 7/8
- Radius: 3/4"
- Spring length: 1-1/4"
- Copper shunt wire

Fits: Brush Holder Assembly
Models: GLC-1, GLC-2, GLC-2B, GLC-3, GLC-4 & R-6000 with gray or black motors

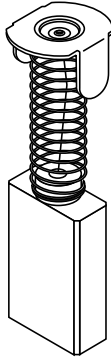

**RPI Part #SRB003
OEM Part #21613**

BRUSH

- 2 per package
- Size: 1/4 x .208 x 1-1/4
- Radius: 1"
- Bevel: 20°
- Copper shunt wire with glass sleeving, and spade terminal

Fits: Brush Holder Assembly
Model: RC-3

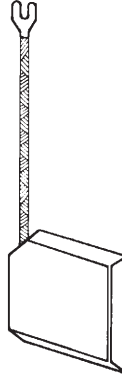

**RPI Part #SRB005
OEM Part #12284**

BRUSH

- 2 per package
- Size: 1/4 x 1 x 1-1/4
- Radius: 1-1/4"
- Bevel: 20°
- No spring
- Copper shunt wire with glass sleeving and spade terminal

Fits: Brush Holder Assembly
Models: RC-2B, RC-5, RC-5B, RC-5C & RT-6000

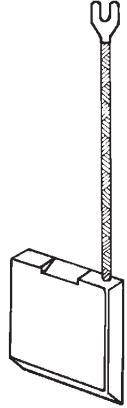

**RPI Part #SRB002
OEM Part #12279**

BRUSH

- 2 per package
- Size: 1/4 x 7/16 x 3/4
- Radius: 3/4"
- Spring length: 1-1/8"
- Copper shunt wire

Fits: Brush Holder Assembly
Models: Motors marked "Howard"

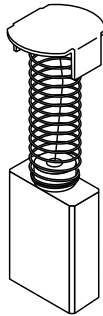

**RPI Part #SRB004
OEM Part #55176**

BRUSH

- 2 per package
- Size: 11/32 x 3/4 x 1-1/8
- Radius: 3/4"
- Spring length: 1-3/4"
- Copper shunt wire
- Includes sensor device

Fits: Brush Holder Assembly
Models: RC-3B & RC-3C

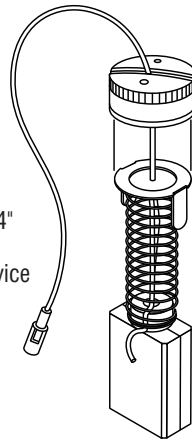

Our friendly, knowledgeable customer service representatives are here to assist you.

NOTES:

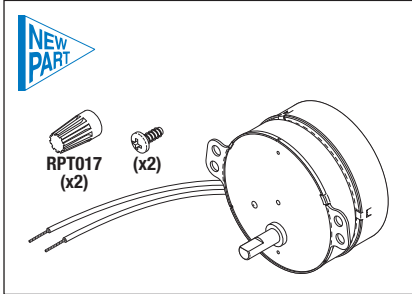

RPI Part #CAM118
OEM Part #42110601/421507/NE110

MOTOR (20 RPM, 230V)

- Bi-directional operation
- Offset shaft
- Includes all parts as shown

Fits: Motor Housing

Model: 421106 Nutator

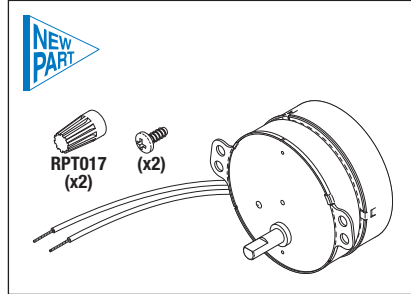

RPI Part #CAM116
OEM Part #42110501/4210504/NE100

MOTOR (24 RPM, 115V)

- Bi-directional operation
- Offset shaft
- Includes all parts as shown

Fits: Motor Housing

Models: 421105 Nutator & S0500 GyroMini

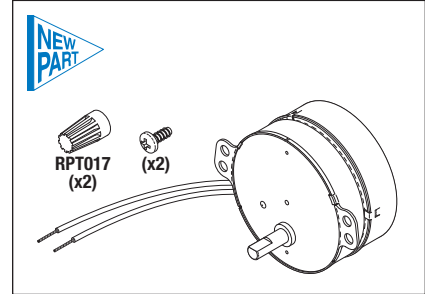

RPI Part #CAM117
OEM Part #NE111

MOTOR (18 RPM, 115V)

- Bi-directional operation
- Offset shaft
- Includes all parts as shown

Fits: Motor Housing

Model: S0600 Enduro MiniMix

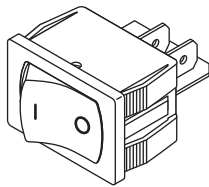

RPI Part #CAS122
OEM Part #NE210

POWER SWITCH

- Rocker switch
- 16A @ 250VAC; SPST
- .187" Tabs
- Color: Black Body with white I/O marking

Fits: Chassis

Models: S0500 GyroMini, S0600 Enduro MiniMix & H5500 Mini LabRoller

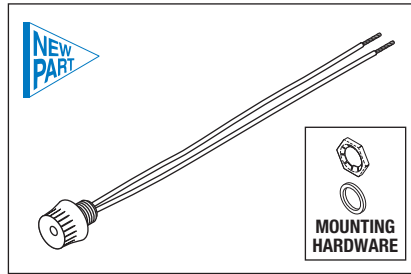

RPI Part #CAS119
OEM Part #42110502/421505

POWER SWITCH

- Rotary style: On-Off-On-Off
- 3A @ 125VAC; SPST
- Includes all parts as shown
- Wire length: ~6" lg.

Fits: Chassis

Model: 421105 Nutator

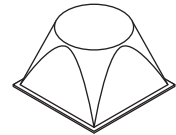

RPI Part #RPB866
OEM Part # (No OEM Part # Available)

BUMPER/FOOT

- 4 per package
- Size: .81" Square x .52" Ht.
- Material: Grey Polyurethane
- Self adhesive backing

Fits: Base

Model: 421105 Nutator

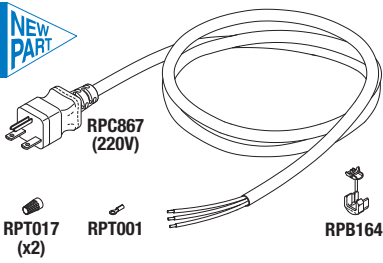

RPI Part #CAK121
OEM Part # (No OEM Part # Available)

POWER CORD KIT

- Length: ~8 ft.
- 220VAC
- Includes all parts as shown
- Also available: Strain Relief Bushing Pliers (RPI Part #RPT172)

Fits: Chassis

Model: 421106 Nutator

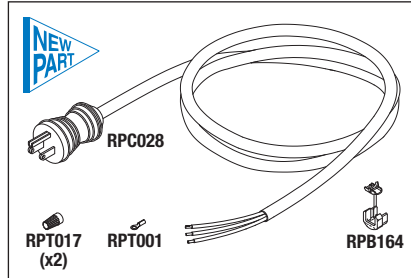

RPI Part #CAK120
OEM Part #42110503/421503

POWER CORD KIT

- Length: ~8 ft.
- 115VAC
- Includes all parts as shown
- Also available: Strain Relief Bushing Pliers (RPI Part #RPT172)

Fits: Chassis

Model: 421105 Nutator

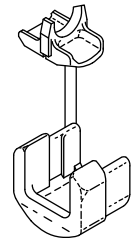

RPI Part #RPB164
OEM Part # (No OEM Part # Available)

STRAIN RELIEF BUSHING

- 8 per package
- Type: SR-6N3-4
- Cord Type: .325" - .360" round cable
- Mounting Hole: 5/8" x 1/8" THK max.
- Included in: Power Cord Kits (RPI Part #'s CAK120 & CAK121) and Strain Relief Bushing Kit (RPI Part #RPK412)
- Also available: Strain Relief Bushing Pliers (RPI Part #RPT172)

Fits: Motor Hood, Chassis

OEM MODEL Section 4 Page #'s

DENTAL CHAIRS

A-DEC

Cascade 1040	200-203
Decade 1010	200-203
Decade 1011	200-203
Decade 1015	200-203
Decade 1020	200-203
Decade 1021	200-203
Performer I	200-203
Performer II	200-203
Performer III	200-203
Positioner 1030	200-203
Priority 1005	200-203

DENTALEZ®

E-1	300
Elegan	300
JS	300
JSA	300
PL-100	300
PL-200	300
PLA200	300
VS	300

PELTON & CRANE

Chairman	304 & 305
Chairman 5000	306
Chairman 5010	306
Chairman 5090	306
Coachman	307
Coachman II	307

RITTER®

FL - Type: 75 Series	302 & 303
----------------------	-----------

DENTAL COMPRESSORS

AIR TECHNIQUES, APOLLO/MIDMARK®, DENTALEZ®/CUSTOM AIR/RAMVAC, JUN-AIR, MATRX/MIDMARK®, MDT MCKESSON, MIDMARK®, PELTON & CRANE & TECH WEST

INDEX TO PARTS BY COMPONENT OR TYPE OF PART

AUTO DRAINS AND FLOATS	407, 408 & 412
BELTS AND BELT TOOL	413
BOWLS (AUTO & MANUAL DRAIN)	409, 411 & 412
CAPACITORS	414
CHECK VALVES	415
CIRCUIT BREAKERS (See Power Switches & Circuit Breakers)	
COALESCING FILTER ASSEMBLIES & REPLACEMENT PARTS	407-409
COLLECTION CONTAINERS (See Oil & Collection Containers)	
COMPRESSOR HEAD COMPONENTS	419
COMPRESSOR PM KITS	400-406
- Lubricated Compressor PM Kits	400-402
- Oil-Less Compressor PM Kits	403-406
COOLING FANS & ACCESSORIES	416
DRYERS	418
DESICCANTS & DESICCANT TANK FILTERS	417
DIFFERENTIAL PRESSURE INDICATORS	407-411 & 420 (continued)

OEM MODEL Section 4 Page #'s

DENTAL COMPRESSORS (continued)

INDEX TO PARTS BY COMPONENT OR TYPE OF PART (continued)

FILTERS	407-411 & 421-426
- Air Intake Filters	421-423
- Coalescing and Particulate Filter Elements	407-411, 424 & 425
- Fresh Air Intake Filters	421-422
- Foam Inserts/Purge Filters/Purge Mufflers	422 & 426
FITTINGS	407, 408, 427 & 428
INLET & OUTLET SHUTTLE DISKS	418
MOISTURE INDICATORS	416
MOUNTING BRACKETS	407-412
OIL & COLLECTION CONTAINERS	429 & 430
OUTLET & INLET SHUTTLE DISKS (See Inlet & Outlet Shuttle Disks)	
PARTICLE FILTER ASSEMBLIES & REPLACEMENT PARTS	410
PARTICULATE FILTER ASSEMBLY & REPLACEMENT PARTS	411
POWER SWITCHES & CIRCUIT BREAKERS	431
PRESSURE GAUGES	434
PRESSURE RELIEF VALVES	433 & 434
PRESSURE SWITCHES & VALVES	433 & 434
RELAYS	432
SAFETY VALVES	435
SIGHT GLASSES & SIGHT GLASS TOOL	435
SOLENOID VALVES & REPAIR KITS	436-438
START BOXES	439
START & RUN CAPACITORS (See Capacitors)	
THERMAL PROTECTOR ASSEMBLIES	440
TOOLS & ACCESSORIES	413, 416, 430, 435 & 441
TOOLS - GREASE GUN & ACCESSORIES FOR SCROLL COMPRESSORS	441
TRANSFORMERS	432
TUBING & ACCESSORIES	442
UNLOADER VALVES	443

DENTAL DELIVERY SYSTEMS/UNITS

A-DEC

INDEX TO PARTS BY COMPONENT OR TYPE OF PART

BARBS & BARB KITS	516 & 517
CARTRIDGES, PISTONS, POPPETS & STEMS	519-521
CABLE MANAGEMENT (Refer to General Shop Aids, Section 6)	
CLAMPS	516 & 517
CONTROL HEAD COMPONENTS	507 & 508
COOLANT CONTROL COMPONENT PARTS, KITS & EXPLODED VIEW	511
- Coolant Air Valve (22-0940-00)	511
- Coolant Water Valve (22-0960-00 & 22-0790-00)	511
- Water Coolant Relay Assembly 500 Series (38.1810.00)	511
DIAPHRAGMS	518
FILTERS	510
- Air Filter Regulator (026-021-01)	510
- Filter/Moisture Separator (026-066-00)	510
- Filter Regulators (24-0168-00, 24-0170-00 & 24-0175-00)	510
- In Line Filter Assembly (19-0100-00)	510
- Utility Module (24-0352-00)	510
- Water Filter Regulator (40-0654-00)	510 (continued)

Dental Equipment

OEM MODEL Section 4 Page #'s

DENTAL DELIVERY SYSTEMS/UNITS (continued)

A-DEC (continued)

INDEX TO PARTS BY COMPONENT OR TYPE OF PART

FOOT CONTROL KITS, PARTS & EXPLODED VIEWS . . .	513-515
- Foot Control Accessory Button (38.0612.00)	508
- Foot Control 300 Series (38.1821.00)	513-515
- Foot Control 500 Series (38.1805.00)	513-515
- Foot Control (38-0050-00)	513-515
- Foot Control II (38-0254-00)	513-515
- Foot Control III (38.1601.00, 38.1603.00 & 38.1700.00)	513-515
- Foot Control Lever Action (38-0200-00)	513-515
GASKETS	518
HANDPIECE CONTROL BLOCKS, PARTS, KITS & EXPLODED VIEWS	500-507
- Handpiece Control Block 300 Series (38.1831.00)	501 & 502
- Handpiece Control Block 500 Series (38.1776.00)	500-502
- Handpiece Control Block Century Plus (38.0540.00)	503-505
- Handpiece Control Block Century II (38.0223.00)	506 & 507
- Handpiece Control Block Century Water Valve Assembly (38.0098.00)	507
KNOBS	507
O-RING, O-RING KITS, TOOLS & LUBRICANT	522-524
PISTONS, POPPETS, STEMS & CARTRIDGES	519-521
POPPETS, PISTONS, STEMS & CARTRIDGES	519-521
RETAINING SPRINGS & RINGS	529
REGULATOR KITS & PARTS	512
- Air and Water Filter Regulator (40-0654-00)	512
- Air and Water Shut-Off Valve (Air Operated) (30-0330-00)	512
- Air Filter Regulator (026-021-01)	510 & 512
- Air Regulator Valve "White Bodies" (24-0135-00)	509
- Filter Regulators (24-0168-00, 24-0170-00 & 24-0175-00)	509 & 510
- Water Filter Regulator (40-0654-00)	510 & 512
- Water Regulator Valve "Black Bodies" (24-0355-00)	509
SALIVA EJECTOR TIPS	527
SCREWS & KIT	525 & 526
SLEEVES	516 & 517
SLEEVE TOOLS (Sizes: 1/8", 1/4" & Universal)	516
SPRINGS	528
STRAIGHT PINS (For Valves, Valve Assemblies & Syringes)	508
STEMS, PISTONS, POPPETS & CARTRIDGES	519-521
SYRINGE PARTS	529
TOGGLE VALVES	508
- Cup Fill & 2 Way Momentary Toggle Valves	508
- Wet/Dry Toggle Valve (38.0604.00)	508
TOGGLE VALVE SWITCH	508
TOOLS (Including "Plastic & Metal Tubing Snakes") (Refer to General Shop Aids, Section 6)	
TUBING MANAGEMENT (Refer to General Shop Aids, Section 6)	
UTILITY MODULE KITS, PARTS & EXPLODED VIEW	509 & 510
- Utility Module (24-0352-00)	509 & 510
VACUUM SYSTEMS PARTS & KIT	527
- Vacuum Drain Actuator (40-0742-00)	527
- Vacuum Sink Assembly (55-0200-00)	527
VALVE CORE REMOVAL/SYRINGE TOOL	529
VALVES - CHECK VALVE & MICRO VALVE	508
WASHERS	517

(continued)

OEM MODEL Section 4 Page #'s

DENTAL DELIVERY SYSTEMS/UNITS (continued)

PELTON & CRANE

Spirit ®	550-553
Spirit ® II	550-553
Spirit ® IIE	550-553
Spirit ® AC	551-553
Spirit ® EC	550-553

DENTAL EQUIPMENT TOOLS

DENTAL TOOLS

Dental Tools	1500
-------------------------------	------

DENTAL FILM PROCESSORS

AIR TECHNIQUES

A/T2000	600 & 601
A/T2000 Plus	600 & 601
A/T2000 XR	600 & 601
Peri Pro I ® (90000)	602-608
Peri Pro II ® (91000)	602-608
Peri Pro III ® (94000)	602-608

DENT-X (Phillips)

810 & 9000 Developer Transport Module	700-702
810 & 9000 Fixer Transport Module	700-702
810 & 9000 Washer/Dryer Transport Module	700-702

GENDEX

GXP ™	850-853
------------------------	---------

LITTON

P4	800
P6	800
P10	800

DENTAL LABORATORY EQUIPMENT

NEY (Porcelain Ovens)

650	900 & 901
660	900 & 901
Mark II	900 & 901
Mark III	900 & 901
Mark IV	900 & 901

RAY FOSTER

10" & 12" Trimmer	903
--	-----

(continued)

OEM MODEL Section 4 Page #'s

DENTAL LABORATORY EQUIPMENT *(continued)*

WELLS (Engine units: U900, U901, U903 & U904)

Arms: AS011 (Piccolo Engine Arm)	902
Arms: AS012 (Standard Engine Arm)	902
Arms: AS051 (Whisper Short Arm)	902
Arms: (Whisper Long Arm)	902
Foot Controls: F011 & F013	902
Hood & Motor: E026, E027, E028 & E029	902
Motor: Baldor - E132 & E133	902
Motor: Bodine (Large Brush) - E-131	902
Motor: Bodine (Small Brush) - E-129 & E-130	902
Motor: WSM	902

WHIP MIX

Vac-U-Vester	903
--------------------	-----

DENTAL LAMPS & BULBS

DENTAL LAMPS & BULBS

Various OEMs and Models	1000
-------------------------------	------

DENTAL LIGHTS

A-DEC

6300 Series	1100 & 1101
Performer	1101

BELMONT & HEALTHCO

Belmont Clesta 501	1205
Belmont Clesta 502	1205
Belmont Clesta 505	1205
Belmont X-Calibur	1202-1204
Healthco X-Calibur	1202-1204

CASTLE

Accuvision	1201
Panavision	1201

KNIGHT by Midmark®

"L" Operating Light	1200
"K" Super Starlite	1200

MARUS

Luxstar	1200
CL1000	1200
UL1000	1200
TL1000	1200

PELTON & CRANE

LF Series	1300-1303
LF+ Series	1300-1303
LFII Series	1304-1311
LFIII Series	1304-1311

RITTER

"J" Starlite	1200
"K" Super Starlite	1200

(continued)

OEM MODEL Section 4 Page #'s

DENTAL LIGHTS *(continued)*

HENRY SCHEIN® DENTAL

Crusader Style, Starbrite 800-1	1200
Crusader Style, Starbrite 800-3	1200
Crusader Style, Starbrite 800-5	1200
Crusader Style, Starbrite 800-7	1200

DENTAL MOTORS

EMESCO

"N" Series	1400
------------------	------

RITTER

C & D	1400
E, F & J	1400

WELLS

All Models	1400
------------------	------

DENTAL ULTRASONIC CLEANERS

L&R

L&R	1550 & 1551
-----------	-------------

NEY (DENTSPLY)

Ney (Dentsply)	1550 & 1551
----------------------	-------------

PATTERSON DENTAL

Patterson Dental	1550 & 1551
------------------------	-------------

HENRY SCHEIN® DENTAL

Henry Schein Dental	1550 & 1551
---------------------------	-------------

DENTAL ULTRASONIC SCALERS

DENTSPLY

Cavitron® BOBCAT® 25 KHz - G115	1600-1609
Cavitron® BOBCAT® Pro - G130	1600-1609
Cavitron® DualSelect™ Dispensing System - G118	1600-1609
Cavitron® JET Plus™ - G132	1600-1609
Cavitron® JET Plus™ - G137	1600-1609
Cavitron® JET with SPS™ - G120	1600-1609
Cavitron® Plus™ Scaler - G131	1600-1609
Cavitron® Plus™ Scaler - G136	1600-1609
Cavitron® Prophy-JET® Air Polishing System - G122	1600-1609
Cavitron® Prophy-JET - G138	1600-1609
Cavitron® Select™ Scaler 25K - G121	1600-1609
Cavitron® Select™ SPS™ 30K - G124	1600-1609
Cavitron® SPS™ Surface Mount Ultrasonic Scaler - G98a	1600-1609
Cavitron® SPS™ Ultrasonic Scaler - G119	1600-1609
Cavitron® Touch™ Scaler - G1000	1600-1609

(continued)

Dental Equipment

OEM MODEL Section 4 Page #'s

DENTAL VACUUM UNITS

AIR TECHNIQUES, APOLLO/MIDMARK®, DENTALEZ®/CUSTOM AIR/RAMVAC, MATRX/MIDMARK®, MIDMARK®, TECH WEST & VADA TRAPS

INDEX TO PARTS BY COMPONENT OR TYPE OF PART

ANTI-SYPHON VALVES & REPAIR KITS	1707
BRUSH KIT	1712
CAPACITORS	1717
CHECK VALVES & REPAIR KITS	1704 & 1710
CIRCUIT BREAKERS	1718
CUSPIDOR DRAIN VALVE (VADA TRAP) & BOWL KITS ...	1701
DIAPHRAGMS	1701
DRAIN ASSEMBLY	1715
DRIVE BELTS & BELT TENSIONER TESTER	1711
FAN	1716
FILTER ELEMENTS, SCREENS & ASSEMBLIES 1703, 1713 & 1715	
FLOAT ASSEMBLIES	1714
FLOAT SWITCHES	1715
FLOW REGULATORS	1708
FUSES & FUSE HOLDERS	1720
GASKETS (CAS COVER, FLANGE & SEPARATOR LID) ...	1714
HARDWARE: FLAG TERMINAL	1709
HOUR METER	1716
LIMIT SWITCH	1719
MANIFOLD GASKETS	1704
PILOT LIGHT	1716
PLUMBING: ACCESSORIES	1709
PLUMBING: FITTINGS & POLYFLO NUT	1709
POWER SWITCHES	1718 & 1719
PUMP REPAIR KIT	1712
RELAYS & RELAY SOCKET	1721
SINK DRAIN VALVE	1701
SOLENOID VALVE ASSEMBLIES & REPAIR KITS ...	1706 & 1707
SOLIDS COLLECTORS, BOWL KITS & SCREENS	1700 & 1710
SOLIDS COLLECTORS REPLACEMENT KITS	1700 & 1710
STRAINERS (WATER) & STRAINER ELEMENTS	1705
SWITCHES (SOLID STATE)	1719
SYNTHETIC OIL	1712
TANK WASHOUT KIT & TUBING	1712
THERMAL OVERLOAD SWITCHES	1719
THERMOSTAT	1716
TRANSFORMERS	1716
VACUUM GAUGES	1702
VACUUM RELIEF VALVES & REPAIR KITS	1703 & 1715
VALVE (SHUT OFF)	1708
WATER CONTROL ASSEMBLIES	1705

DENTAL X-RAY UNITS

GENDEX

765 DC Intraoral X-Ray	1800
GX-770™ Intraoral X-Ray	1800
Orthoralix® 9000 Panoramic X-Ray	1800

Models: Cascade 1040; Decade 1010, 1011, 1015, 1020 & 1021; Performer I, II & III; Positioner 1030; and Priority 1005

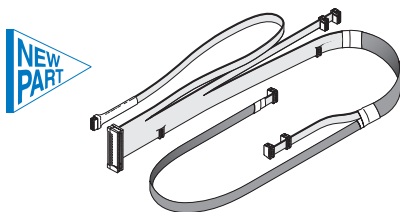

RPI Part #ADC204
OEM Part #61.0612.00

CABLE ASSY (MAIN)
• Overall length: ~46"
Fits: Connects Chair Top, Chair Seat & Chair Base Assemblies
Model: Priority 1005 (Serial #M1-0001 thru D3-0134)

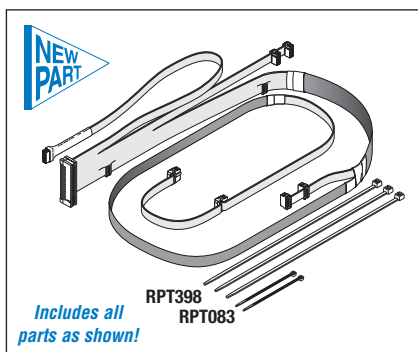

RPI Part #ADC207
OEM Part #61.0599.00

CABLE ASSY (MAIN)
• Overall length: ~68"
Fits: Connects Chair Top, Chair Seat & Chair Base Assemblies
Model: Priority 1005 (Serial #D3-0135 thru H3-0067)

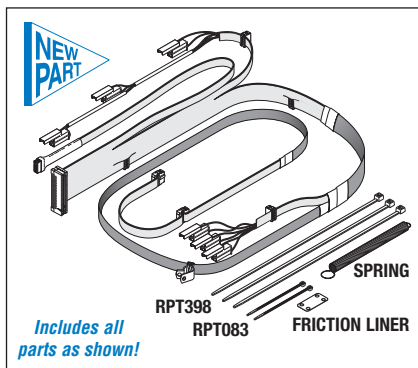

RPI Part #ADK208
OEM Part #61.0668.00

CABLE ASSY (MAIN COMPLETE)
• Overall length: ~70.50"
• Also available Switch Assembly (Tilt Limit) (RPI Part #ADA228)
Fits: Connects Chair Top, Chair Seat & Chair Base Assemblies
Model: Priority 1005 (Serial #H3-0068 thru present)

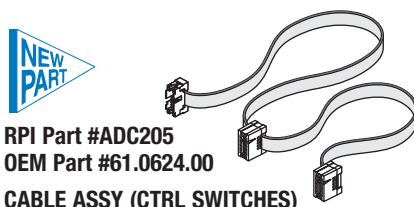

RPI Part #ADC205
OEM Part #61.0624.00

CABLE ASSY (CTRL SWITCHES)
• Overall length: ~24"
Fits: Chair Back Assembly
Model: Priority 1005 (Serial #M1-0001 thru D3-0134)

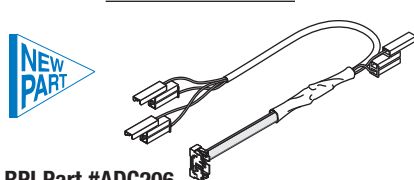

RPI Part #ADC206
OEM Part #61.0613.00

CABLE ASSY (LIFT LIMIT)
• Overall length: ~18.25"
Fits: Base Assembly
Model: Priority 1005 (Serial #M1-0001 thru H3-0067)

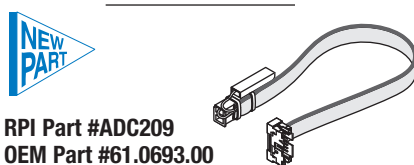

RPI Part #ADC209
OEM Part #61.0693.00

CABLE (PRE-POSITION BASE)
• Overall length: ~12.50"
Fits: Connects the Main Cable to Lift Pre-Position Assembly (OEM Part #61.0593.00)
Model: Priority 1005 (Serial #H3-0068 thru present)

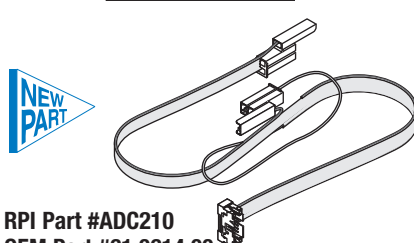

RPI Part #ADC210
OEM Part #61.0614.00

CABLE ASSY (STOP PLATE)
• Overall length: ~23.50"
Fits: Base Assembly
Model: Priority 1005 (Serial #M1-0001 thru present)

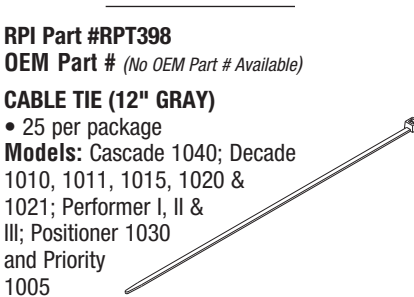

RPI Part #RPT398
OEM Part # (No OEM Part # Available)

CABLE TIE (12" GRAY)
• 25 per package
Models: Cascade 1040; Decade 1010, 1011, 1015, 1020 & 1021; Performer I, II & III; Positioner 1030 and Priority 1005

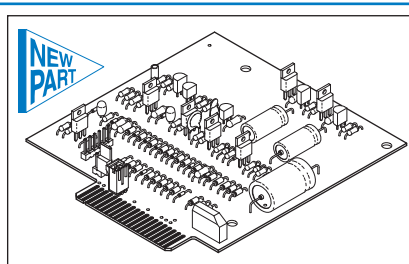

RPI Part #ADB203
OEM Part #61.0688.00, 61-0833-00 & 61-0616-00

CIRCUIT BOARD ('A' BOX)
• RPI added jumper system for LK 1 to disable the pre-position functions
Fits: "A" Box
Model: Priority 1005 (Serial #M1-0001 thru present)

RPI ADVANTAGE!
Header System is added to the test points for easy testing of chair functions.

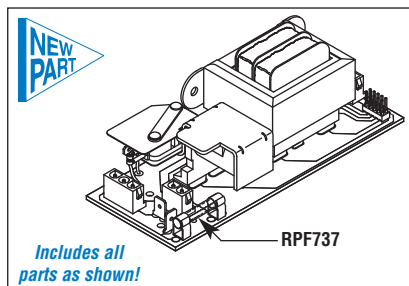

RPI Part #ADB219
OEM Part #61.0645.00

CIRCUIT BOARD ('B' BOX)
• 100/120 VAC
Fits: "B" Box
Model: Priority 1005 (Serial #M1-0001 thru present)



RPI Part #RPF737
OEM Part #046-070-00

FUSE (0.6A, 250V) - 5/pkg
• Type: Glass; 3AG Time Delay
• Size: 1/4" dia. x 1-1/4" lg
Fits: Circuit Board "B" Box
Model: Priority 1005 (Serial #M1-0001 thru present)

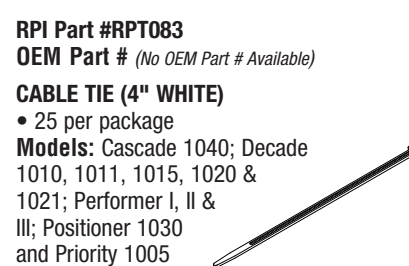







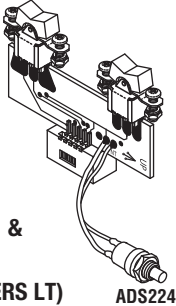

RPI Part #RPT083
OEM Part # (No OEM Part # Available)

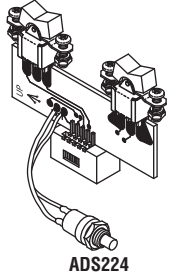
CABLE TIE (4" WHITE)
• 25 per package
Models: Cascade 1040; Decade 1010, 1011, 1015, 1020 & 1021; Performer I, II & III; Positioner 1030 and Priority 1005

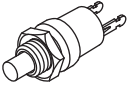
Dental Equipment

Models: Cascade 1040; Decade 1010, 1011, 1015, 1020 & 1021; Performer I, II & III; Positioner 1030; and Priority 1005

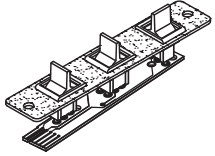
  <p><i>Includes all parts as shown and mounting hardware</i></p> <p>RPI Part #ADA216 OEM Part #61.0661.01 & 61.0656.01</p> <p>SWITCH ASSY (ROCKERS LT)</p> <ul style="list-style-type: none"> • Pre-position (left side only) • White rocker switches <p>Fits: Backrest Assembly (left side only) Model: Priority 1005 (Serial #D3-0135 thru present)</p>	  <p><i>Includes all parts as shown and mounting hardware</i></p> <p>RPI Part #ADA215 OEM Part #61.0661.00 & 61.0656.00</p> <p>SWITCH ASSY (ROCKERS RT)</p> <ul style="list-style-type: none"> • Auto return (right side only) • White rocker switches <p>Fits: Backrest Assembly (right side only) Model: Priority 1005 (Serial #D3-0135 thru present)</p>	  <p>RPI Part #ADS224 OEM Part #041.059.00</p> <p>SWITCH (PUSH-BUTTON)</p> <ul style="list-style-type: none"> • 5A @ 120VAC, 2.5A @ 220VAC • SPST; Momentary; N.O. • Black button <p>Fits: 8 Function Footswitch, Multi-Function Footswitch, Auto Return and Pre-position Assemblies Models: Cascade 1040; Decade 1021; Priority 1005 (Serial #D3-0135 thru present)</p>
--	--	---

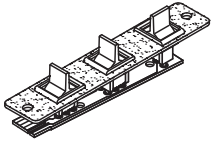
  <p>RPI Part #ADA213 OEM Part #61.0625.00</p> <p>SWITCH ASSY (PADDLES LT)</p> <ul style="list-style-type: none"> • Left side only, pre-position • 3 black paddle switches <p>Fits: Backrest Assembly (left side only) Model: Priority 1005 (Serial #M1-0001 thru D3-0134)</p>	  <p>RPI Part #ADA214 OEM Part #61.0626.00</p> <p>SWITCH ASSY (PADDLES RT)</p> <ul style="list-style-type: none"> • Right side only, auto return • 3 black paddle switches <p>Fits: Backrest Assembly (right side only) Model: Priority 1005 (Serial #M1-0001 thru D3-0134)</p>
--	--

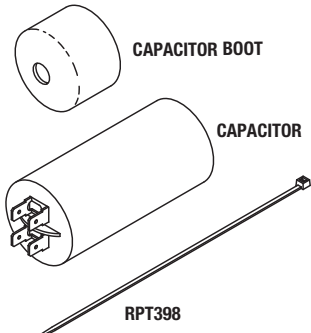

RPI Part #ADK221
OEM Part #041.164.00 & 90.1031.00



CAPACITOR KIT

- 50uf, 280VAC, 50/60Hz
- Size: 1.81" dia x 3.35" tall
- Dual .25" tabs
- For 100VAC, 115VAC, and for 240VAC chairs built before February 13, 2001

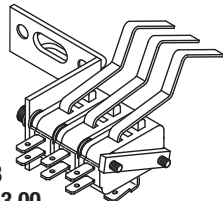
Fits: "B" Box
Models: Cascade 1040; Decade 1010, 1011, 1015, 1020 & 1021; Performer III; Positioner 1030; Priority 1005 (Serial #M1-0001 thru present)

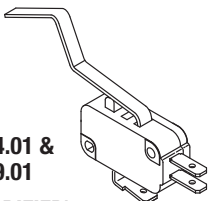
Includes all parts as shown!

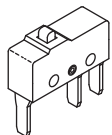
  <p>RPI Part #ADA228 OEM Part #61.0453.00</p> <p>SWITCH ASSY (TILT LIMIT)</p> <ul style="list-style-type: none"> • Includes: (3) Limit Switch (Modified) (RPI Part #ADS211) <p>Fits: Chair Seat Assembly Model: Priority 1005 (Serial #H3-0068 thru present)</p>	  <p>RPI Part #ADS211 OEM Part #044.184.01 & 044.049.01</p> <p>LIMIT SWITCH (MODIFIED)</p> <ul style="list-style-type: none"> • 15.1A @ 125/250 VAC • SPDT; .187" tabs <p>Fits: Various positions and chairs Models: Cascade 1040; Decade 1010, 1011, 1020 & 1021; Performer III; Positioner 1030; Priority 1005</p>
--	---

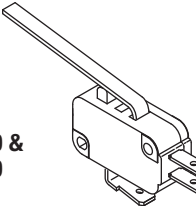
  <p>RPI Part #ADS223 OEM Part #041.119.00</p> <p>SWITCH (MINIATURE)</p> <ul style="list-style-type: none"> • 10.1A @ 125/250VAC <p>Fits: 8 Function Footswitch (OEM Part #61.3043.80) 100VAC/120VAC & 240VAC Model: Priority 1005 (Serial #M1-0001 thru present)</p>	  <p>RPI Part #ADS212 OEM Part #044.184.00 & 044.049.00</p> <p>MICRO-SWITCH</p> <ul style="list-style-type: none"> • 15.1A @ 125/250 VAC • SPDT; .187" tabs <p>Fits: Various positions and chairs Models: Decade 1010, 1011, 1020 & 1021; Performer I, II & III</p>
--	--

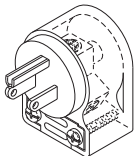

RPI Part #RPP032
OEM Part # (No OEM Part # Available)

HOSPITAL GRADE MALE PLUG (RIGHT ANGLE)

- Made by Hubbell®
- 15A@125VAC
- Accepts 0.255" dia. to 0.665" dia. Cord
- NEMA 5-15P
- Transparent housing

Models: Cascade 1040; Decade 1010, 1011, 1015, 1020 & 1021; Performer I, II & III; Positioner 1030 and Priority 1005

Models: Cascade 1040; Decade 1010, 1011, 1015, 1020 & 1021; Performer I, II & III; Positioner 1030; and Priority 1005

RPI Part #RP0316
OEM Part #030-015-02

- O-RING - (12/PKG)**
- Material: Buna N; Duro: 70
 - Size: .551" ID x .691" OD x .070" C/S
- Fits:** Manifold Assembly
Model: Priority 1005
(Serial #M1-0001 thru L3-0200)

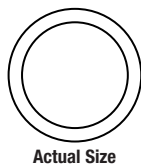

RPI Part #RP0738
OEM Part #35.041.02

- O-RING - (10/PKG)**
- Material: Buna N; Duro: 70
 - Size: .614" ID x .768" OD x .077" C/S
- Fits:** Solenoid Valve - Old Style Hydraulic Manifold O-ring Pocket with or without an ID mark/dot
Model: Priority 1005
(Serial #M1-0001 thru L3-0200)

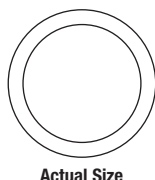

RPI Part #RPT017
OEM Part # (No OEM Part # Available)

- WIRE NUT - (25/PKG)**
- #22-16 AWG; Insulated; Grey
- Models:** Cascade 1040; Decade 1010, 1011, 1015, 1020 & 1021; Performer I, II & III; Positioner 1030 and Priority 1005

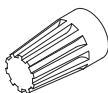

RPI Part #RPT083
OEM Part # (No OEM Part # Available)

- CABLE TIE (4" WHITE) - (25/PKG)**
- Models:** Cascade 1040; Decade 1010, 1011, 1015, 1020 & 1021; Performer I, II & III; Positioner 1030 and Priority 1005



RPI Part #ADW038
OEM Part #004-005-00

- FLAT WASHER - (50/PKG)**
- Fits:** Reservoir
- Models:** Cascade 1040; Decade 1010, 1011, 1015, 1020 & 1021; Performer I, II & III; Positioner 1030 and Priority 1005



RPI Part #ADB011
OEM Part #023-001-01

- BARB - (10/PKG)**
- Fits:** Reservoir
- Models:** Cascade 1040; Decade 1010, 1011, 1015, 1020 & 1021; Performer I, II & III; Positioner 1030 and Priority 1005

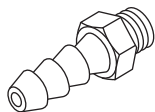

Includes all parts as shown!

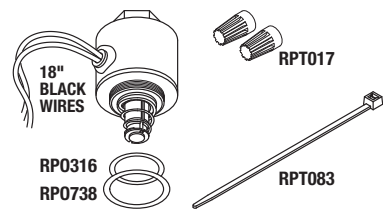

RPI Part #ADK220
OEM Part #60.0601.00

- SOLENOID VALVE REPAIR KIT**
- 24 VDC; 7.4 W; Coil ~78 Ω
- Fits:** Manifold Assembly
Model: Priority 1005
(Serial #M1-0001 thru L3-0200)

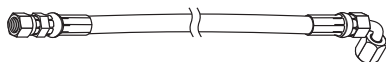

RPI Part #ADH217
OEM Part #61.0217.01

- HOSE ASSY (TILT CYLINDER)**
- Length: ~44.00"
 - Fittings: 7/16-20 Flare Female x 7/16-20 Flare 90° Elbow
- Fits:** Tilt Cylinder
Model: Priority 1005 (Serial #M1-0001 thru present)

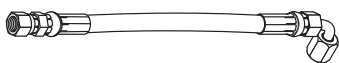

RPI Part #ADH218
OEM Part #61.0218.01

- HOSE ASSY (LIFT CYLINDER)**
- Length: ~10.00"
 - Fittings: 7/16-20 Flare Female x 7/16-20 Flare 90° Elbow
- Fits:** Lift Cylinder
Model: Priority 1005 (Serial #M1-0001 thru present)



Also available by the case (12 bottles) (RPI Part #RPF453)

RPI Part #RPF449
OEM Part #61-0197-00

- HYDRAULIC FLUID**
- 16 fluid ounces
 - Includes Yorker Cap
 - Shell Tellus T46 Oil (ISO 46)
- For:** Pump Reservoir
Models: Cascade 1040; Decade 1010, 1011, 1015, 1020 & 1021; Performer I, II & III; Positioner 1030 and Priority 1005

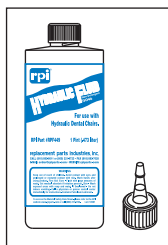

Includes all parts as shown!

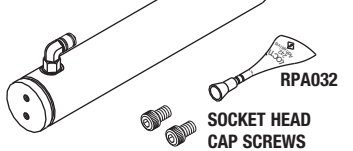

RPI Part #ADC174
OEM Part #61-0860-00

- TILT CYLINDER KIT**
- Fits:** Link Assembly
Model: Priority 1005

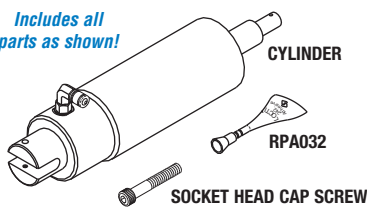

RPI Part #ADC175
OEM Part #61-0850-00

- LIFT CYLINDER KIT**
- Fits:** Between baseplate and upper structure of chair
Model: Priority 1005

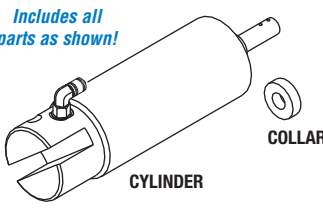

RPI Part #ADC176
OEM Part #61-1287-00

- LIFT CYLINDER KIT**
- Fits:** Between baseplate and upper structure of chair
Models: Cascade 1040; Decade 1010, 1011, 1015, 1020 & 1021; and Performer III

RPI Part #ADC177
OEM Part #61-2050-00

- TILT CYLINDER**
- Fits:** Link Assembly
Model: Cascade 1040

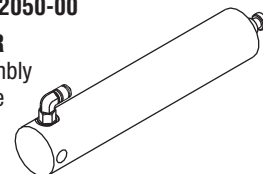

RPI Part #ADC178
OEM Part #61-1267-00

- TILT CYLINDER**
- Fits:** Link Assembly
Models: Decade 1010, 1011, 1015, 1020 & 1021

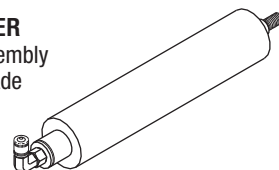

Dental Equipment

Models: Cascade 1040; Decade 1010, 1011, 1015, 1020 & 1021; Performer I, II & III; Positioner 1030; and Priority 1005

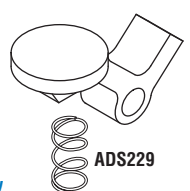



Includes all parts as shown!

RPI Part #ADK222
OEM Part #61.0030.00 (Latch) & 013-017-00 (Compression Spring)

LATCH KIT (ARMREST)

- Material: Nickel plated aluminium
- Fits: Armrest Assembly
- Model: Priority 1005 (Serial #M1-0001 thru present)

RPI Part #ADS229
OEM Part #013-017-00

COMPRESSION SPRING - (10/PKG)

- Material: Stainless steel
- .243" OD x .500" lg x .022" dia wire
- Fits: Latch Kit (Armrest)
- Model: Priority 1005 (Serial #M1-0001 thru present)

RPI Part #RPT295
OEM Part # (No OEM Part # Available)

1/4" SLEEVE TOOL

- Use on 1/4" OD tubing; ~5" lg.
- The tool provides 90° and 45° angles for ease of use

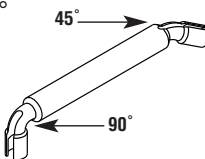

RPI Part #RPT296
OEM Part # (No OEM Part # Available)

UNIVERSAL SLEEVE TOOL

- Use on 1/4" OD and 1/8" OD tubing; ~5" lg.
- The tool provides 90° angles on both ends for ease of use

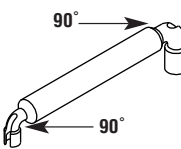



RPI Part #ADC035
OEM Part #025-015-01

SLEEVE CLAMP - (20/PKG)

- Material: Polyurethane
- Fits: 1/4" OD tubing with 1/8" barb
- Also included in: Barb Kit (RPI Part #ADK080)

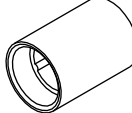
Models: Cascade 1040; Decade 1010, 1011, 1015, 1020 & 1021; Performer I, II & III; Positioner 1030 and Priority 1005



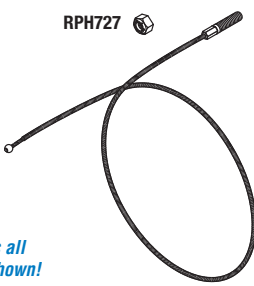



Includes all parts as shown!

RPI Part #ADC226
OEM Part #61.0025.00 (Cable) & 006.023.00 (Nut)

BRAKE CABLE

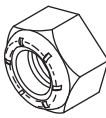
- ~25.31" Long; Clear Nylon® Jacket
- Stainless steel cable and fittings
- Fits: Swivel and Brake Assembly
- Model: Priority 1005 (Serial #M1-0001 thru H3-0067)

RPI Part #RPH727
OEM Part #006.023.00

HEX NUT (1/4-20)

- 10 per package
- Stainless Steel with Nylon® Insert
- Fits: Brake Cable Assembly
- Model: Priority 1005 (Serial #M1-0001 thru H3-0067)



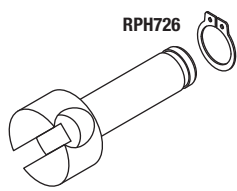

Includes all parts as shown!

RPI Part #ADM225
OEM Part #61.0081.00 (Mount) & 010.028.00 (Retaining Ring)

MOUNT (BRAKE CABLE)

- Material: Nickel plated steel
- Fits: Swivel and Brake Assembly
- Model: Priority 1005 (Serial #M1-0001 thru H3-0067)

RPI Part #RPH726
OEM Part #010.028.00

RETAINING RING (EXTERNAL)

- 10 per package
- Material: Stainless steel
- For .281" OD shaft
- Fits: Brake Mount
- Model: Priority 1005 (Serial #M1-0001 thru H3-0067)

Articulating Headrest Parts (Misc)

RPI Part #ADS045
OEM Part #013-022-00

SPRING - (10/PKG)
Fits: Articulating Headrest



RPI Part #ADS062
OEM Part #19-0230-00

SPRING - (10/PKG)
Fits: Articulating Headrest

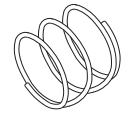

RPI Part #RPO316
OEM Part #003-015-00

O-RING - (12/PKG)
Fits: Articulating Headrest

Actual Size

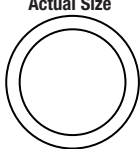

Manifold Parts (Misc)

RPI Part #ADS169
OEM Part #002-118-00

BUTTON HEAD CAP SCREW - (5/PKG)
Fits: All one piece hydraulic Manifolds Flow Adjustment

Models: Cascade, Decade, Performer, Positioner 1030 and Priority 1005



RPI Part #ADS052
OEM Part #001-002-00

TRUSS HEAD SLOTTED SCREW - (10/PKG)
Fits: All two piece hydraulic Manifold Flow Adjustment

Models: Cascade, Decade, Performer, Positioner 1030 and Priority 1005



RPI Part #RPO312
OEM Part #030-004-00

O-RING - (12/PKG)
Fits: Manifold Flow Adjustment (see Footnotes 1 & 2 below) and Check Valve Stem (see Footnote 2 below)

Actual Size



RPI Part #RPO305
OEM Part #030-010-00

O-RING - (12/PKG)
Fits: Manifold Block Separators (see Footnotes 1 & 2 below)

Actual Size



RPI Part #RPO303
OEM Part #030-012-00

O-RING - (12/PKG)
Fits: Manifold Check Valve Tube Fitting (see Footnotes 1 & 2 below) and Elbow Flare Fitting (see Footnote 2 below)

Actual Size

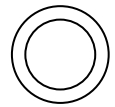

RPI Part #RPO317
OEM Part #030-016-00

O-RING - (12/PKG)
Fits: Manifold Pressure Relief Valve (see Footnote 1 below)

Actual Size

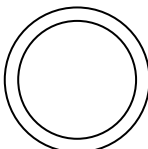

MANIFOLD O-RING FOOTNOTES

(1) Fits Priority 1005 (Serial # M1-0001 thru L3-0200)

(2) Fits Priority 1005 (Serial # L3-0201 thru present)

RPI Part #DEA603
OEM Part # (None)

ACTUATOR

- White plastic with brass insert
 - 1/4-40 right hand thread
- Fits:** Chair Back Motor
(OEM Part 3574-082)
Models: E-1, JS & VS

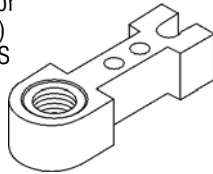

RPI Part #DEA612
OEM Part # (None)

ACTUATOR

- Blue plastic with brass insert
 - 1/4-28 left hand thread
- Fits:** Chair Back Motor
(OEM Part #3574-046,
3574-107, 3574-033 & DZ1)
Models: JS & VS

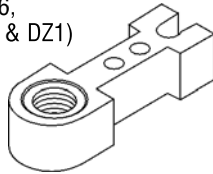

RPI Part #DEA613
OEM Part # (None)

ACTUATOR

- Red plastic with brass insert
 - 1/4-28 right hand thread
- Fits:** Chair Seat Motor
(OEM Part #3574-044 & 3574-026)
Models: JS & VS

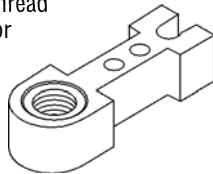

RPI Part #DEA614
OEM Part # (None)

ACTUATOR

- Black plastic with brass insert
 - 1/4-64 left hand thread
- Fits:** Base Motor
(OEM Part #3574-21)
Models: PL-200,
PLA-200 & Elegan

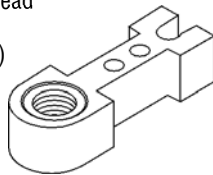

RPI Part #DEC610
OEM Part #3800-067

CAPACITOR

- 115 V, 53-64 MFD, 330 VAC
- Fits:** Base Motor
Models: PL-200,
PLA200 & Elegan

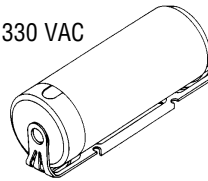

RPI Part #DEG601
OEM Part #3800-151

SEAT TILT MOTOR GEAR

- White plastic with steel insert
 - 30 teeth
- Fits:** Seat Tilt Motor
Models: JS, VS,
PL-100 & PLA200
D-12 Motor

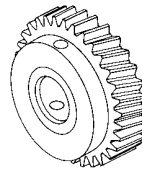

RPI Part #DEG602
OEM Part #3800-150

BACK MOTOR GEAR

- White plastic with steel inserts
 - 29 teeth
- Fits:** Back Motor
Models: JS, JSA,
PLA200 & VS

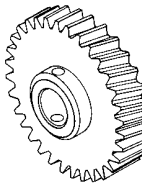

RPI Part #DES605
OEM Part #3800-100

MOMENTARY SWITCH

- Momentary ON/OFF/Momentary ON
 - Long narrow smooth white rocker
 - 6 A @ 125 VAC; 3 A @ 250 VAC;
 - 1/4 HP, 125-250 VAC
- Fits:** Chair Back
Models: JS, JSA & VS

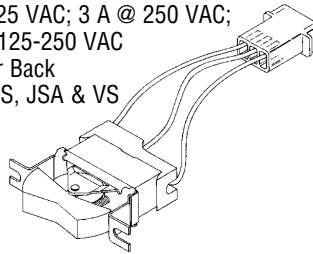

RPI Part #DES606
OEM Part #3800-101

AUTO POSITION SWITCH

- Momentary ON/OFF/Momentary ON
 - Long narrow cross serrated white rocker
 - 6 A @ 125 VAC; 3 A @ 250 VAC;
 - 1/4 HP, 125-250 VAC
- Fits:** Chair Back
Models: JS & VS

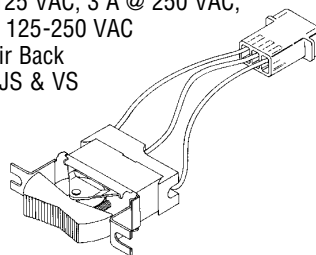

RPI Part #DES607
OEM Part #3800-148

ON/OFF/ON SWITCH

- ON/OFF/ON
 - Long narrow smooth white rocker
 - 6 A @ 125 VAC; 3 A @ 250 VAC;
 - 1/4 HP, 125-250 VAC
- Fits:** Chair Back
Models: JS & VS

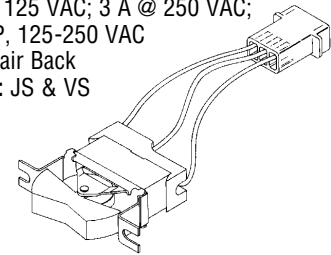

RPI Part #DES608
OEM Part #3800-006

MOTOR LIMIT SWITCH

- 2 per package
 - Normally Closed
 - 10 A, 1/2 HP @ 125/250 VAC
- Fits:** Base, Seat Tilt and Back Motor
Models: JS & VS

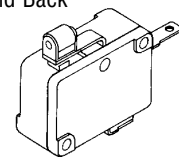

RPI Part #DES609
OEM Part #3800-155

ROCKER SWITCH

- Momentary ON/OFF/Momentary ON
 - 5/8" cross serrated black rocker
 - 6 A @ 25 VAC;
 - 3 A @ 250 VAC;
 - 1/4 HP, 125-250VAC
- Fits:** Chair Back
Models: JS & VS

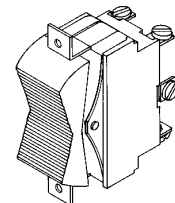

RPI Part #DES611
OEM Part #3800-112

ARM SCREW

- 2 per package
 - 5/16-24 x .860" long
 - Stainless steel
- Fits:** Control Sleeve
Models: JS & VS

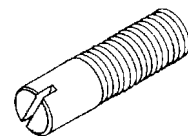

Service Tip

The actuators, gears, and motor limit switches also fit Gearmaster® motors. Gearmaster motors are used in other dental chairs and industrial equipment.

*Gearmaster is a registered trademark of Emerson Electric, Co.

You can depend on RPI for quality parts. We guarantee it!

Dental Equipment



NOTES: _____

RPI Part #RCA061
OEM Part #144648

METERING SCREW ASSEMBLY

- Brass
- Includes metering screw with O-rings (RPI Part #RPO306 & RPO307)
- Fits:** Solenoid Valve
- Model:** FL **Type:** 75, 75-C, 7-F & All models using old style Solenoid Coil



New RPI Part #RPO307
Old RPI Part #RC0040
OEM Part #P-12233 & 146180
Industry Part #2-006

O-RING

- 12 per package
- Material: Buna-N
- Hardness: 70 Duro
- .1/4" OD x .1/8" ID x 1/16" C/S
- Fits:** Solenoid Metering Screw
- Model:** FL **Type:** 75, 75-C & 7-F



RPI Part #RCC062
OEM Part #171421

MOTOR STARTING CAPACITOR

- 108–130 MFD, 110–125VAC, 60 Hz.
- Fits:** Motor
- Model:** FL **Type:** 75, 75-C & 7-F

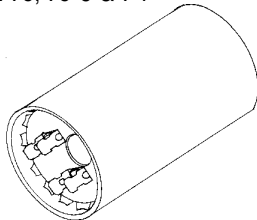

RPI Part #RCC601
OEM Part #14183

SOLENOID COIL

- 49.78 Ω min; 55.02 Ω max; Coil Rating: 120VAC
- Coil: 1.265" OD x 1.335" long with .50" diameter through hole
- Wire: 11" long
- Fits:** Solenoid Valve
- Model:** FL **Type:** 75, 75-C, 7-F, PA, PB, MH, MHL & MHR

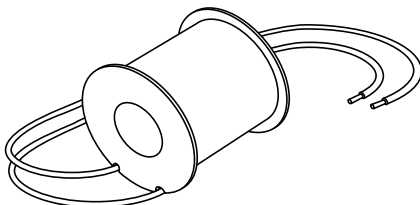

RPI Part #RCK066
OEM Part #144741

SOLENOID BODY KIT

- Includes plunger, spring, spanner nut, and O-ring (RPI Part #RPO301)
- Fits:** Solenoid Valve
- Model:** FL **Type:** 75, 75-C & 7-F

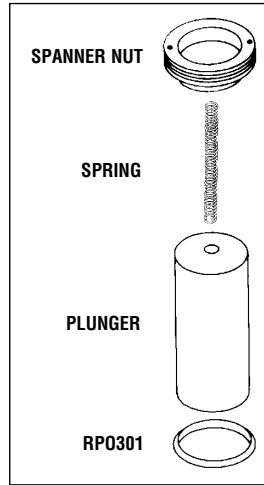

RPI Part #RPO301
OEM Part #C-5970
Industry Part #2-014

O-RING

- 12 per package
- Material: Buna-N (Nitrile)
- Hardness: 70 Duro
- 5/8" OD x 1/2" ID x 1/16" C/S
- Fits:** Solenoid Valve Plunger
- Model:** FL **Type:** 75, 75-C & 7-F

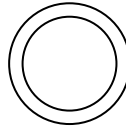

RPI Part #RCC602
OEM Part #143830

FOOT SWITCH CABLE

- Sold by the foot (Reminder: OEM's cable was 5 feet long)
- 7 conductor insulated cable; .53" OD; Jacket 16/7
- For connecting foot control to table
- Models:** All tables and chairs

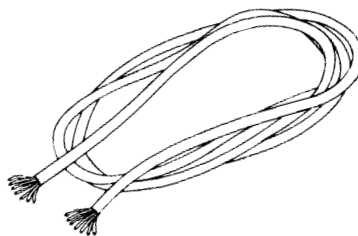

RPI Part #RCM065
OEM Part #141573

MOTOR MOUNT

- 2 per package
- 1/4-20 UNC x 23/64" long x .50" at each end
- Fits:** Motor
- Model:** FL **Type:** 75, 75-C & 7-F

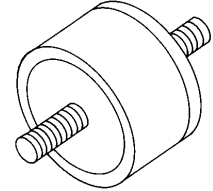

RPI Part #RCM064
OEM Part #155961

VIBRATION MOUNT

- 1/4-20 UNC x .38" long
- Fits:** Motor
- Model:** FL **Type:** 75, 75-C & 7-F

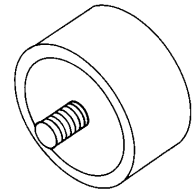

RPI Part #RCP063
OEM Part #C-3872

ROLL PIN

- 12 per package
- 1/8" Diameter x 5/8" long
- Fits:** Tilt Cylinder
- Model:** FL **Type:** 75, 75-C & 7-F

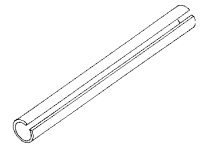

RPI Part #RCP072
OEM Part #425-A-13

STANDPIPE PACKING

- Fits:** Lift Tube
- Model:** FL **Type:** 75, 75-C & 7-F

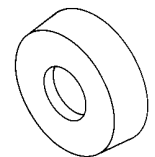

O-Ring illustrations are actual size

RPI Part #PCS720
OEM Part #007899

EXIT SWITCH ASSEMBLY

- Normally Open
- 3/4A@125VAC
- Black button

Fits: Chair Back Assembly
Model: Chairman

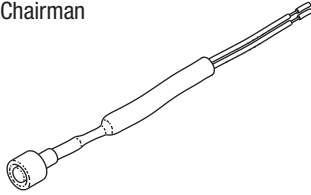

RPI Part #PCS714
OEM Part #007506

FORMED LEVER SWITCH

- 5A@120VAC
- Fits:** Base, Lift & Attachment Assembly
Model: Chairman

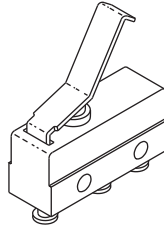

RPI Part #PCS716
OEM Part #007429

TRAVERSE SWITCH

- Momentary contact (On/Off/On)
- 6A@125VAC; 3A@250VAC
- Snap in mounting
- Dark grey paddle

Fits: Back Assembly and Foot Switch Assembly
Model: Chairman

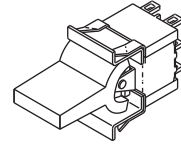

RPI Part #PCS719
OEM Part #007898

OPERATE SWITCH ASSEMBLY

- Normally Open
- 3/4A@125VAC
- Red button

Fits: Chair Back Assembly
Model: Chairman

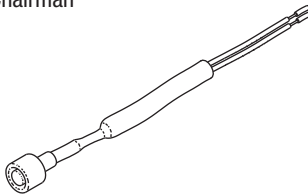

RPI Part #PCS715
OEM Part #007596

TRAVERSE LIMIT SWITCH

- 5A@125/250VAC
- Fits:** Base, Lift & Attachment Assembly
Model: Chairman

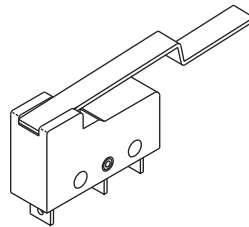

RPI Part #PCS717
OEM Part #007428

TILT SWITCH

- Momentary contact (On/Off/On)
- 6A@125VAC; 3A@250VAC
- Snap in mounting
- White paddle

Fits: Back Assembly (Chairman) and Foot Switch Assembly (Chairman 5090)
Models: Chairman & Chairman 5090

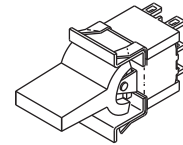

RPI Part #PCS713
OEM Part #007431

ROLLER MICRO SWITCH

- 5A@250VAC
- Fits:** Seat Wiring Assembly
Model: Chairman

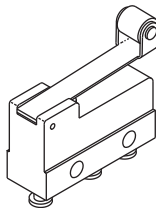

RPI Part #PCP721
OEM Part #007595

FOOT SWITCH PEDAL

- Black ABS plastic
- Fits:** Chair Base Foot Switch Assembly
Model: Chairman

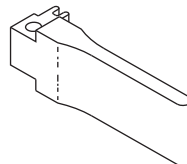

RPI Part #PCS718
OEM Part #007427

LIFT SWITCH

- Momentary contact (On/Off/On)
- 6A@125VAC; 3A@250VAC
- Snap in mounting
- Black paddle

Fits: Back Assembly
Model: Chairman

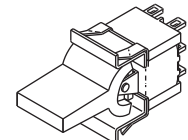

Visit RPI's Website www.rpiparts.com

Dental Equipment

Model: Chairman



RPI Part #PCM745
OEM Part #017628 (Serial #1001-4189) & #007881 (Serial #4190 and above)

LIFT MOTOR

- Includes all parts as shown
- Also available: Grease (RPI Part #RPL717) and Lift Gear (RPI Part #PCG762)

Fits: Base and Lift Assembly
Model: Chairman

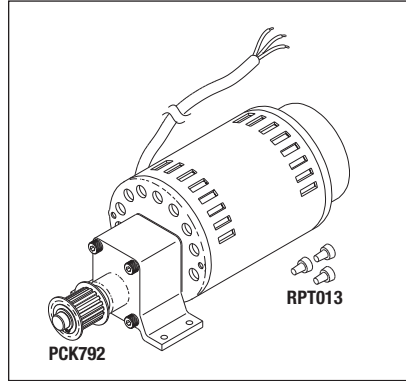

RPI Part #PCK792
OEM Part #007575

LIFT MOTOR PULLEY KIT

- Use with 1" wide XL Series Belt
- 1.146" pitch dia. with 18 grooves
- .500" bore with .125" key slot
- Includes: pulley, woodruff key, and (2) retaining rings

Fits: Lift Motor
Model: Chairman

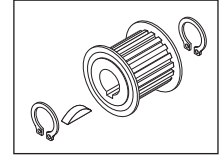

RPI Part #PCK742
OEM Part #011195

BRAKE REPAIR KIT

- Clutch material: ScnaPac 230-F (non-asbestos)
- Includes all parts as shown

Fits: Lift Motor, Base and Lift Assembly
Model: Chairman

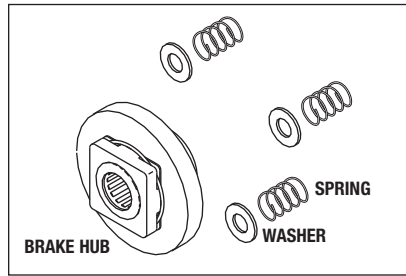

RPI Part #PCG762
OEM Part #024770

LIFT GEAR

- 39 Teeth, Helical
- Includes: Grease (RPI Part #RPL717)

Fits: Lift Motor
Model: Chairman

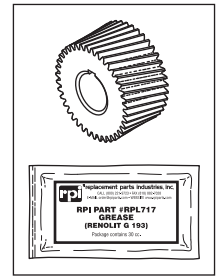

RPI Part #PCK738
OEM Part #012476

GEAR AND RACK

- Steel
- Includes all parts as shown

Fits: Base, Lift and Assembly
Model: Chairman

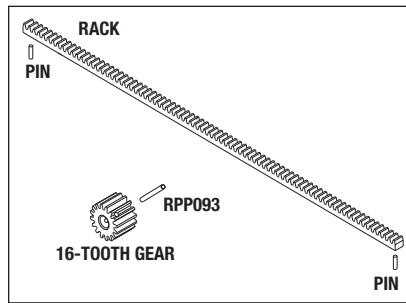

RPI Part #PCG739
OEM Part #022701

TRAVERSE GEAR (SINGLE)

- 17 Teeth
- Includes: Grease (RPI Part #RPL717)

Fits: Traverse Motor
Model: Chairman

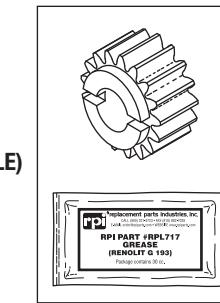

RPI Part #PCB729
OEM Part #017850

PCB ASSEMBLY

- New style PCB

Fits: Seat Assembly
Model: Chairman

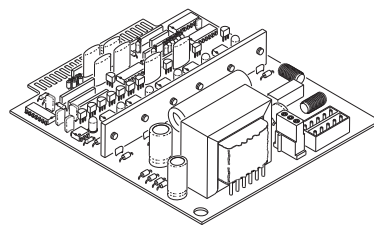

RPI Part #PCG740
OEM Part #024766

TRAVERSE GEAR (DOUBLE)

- 16 Teeth/35 Teeth
- Includes: Grease (RPI Part #RPL717)

Fits: Traverse Motor
Model: Chairman

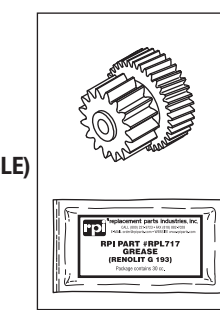

RPI Part #PCC746
OEM Part #007903

COILING WIRE ASSEMBLY

- 14 conductor; #22 AWG
- Rubber boot cover on pin housing

Fits: Seat Support Assembly
Model: Chairman

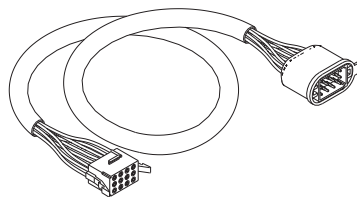

RPI Part #RPL717
OEM Part # (No OEM Part # Available)

GREASE

- 30cc package
- Renolit G 193 Grease
- To be used with gears on Lift Motor and Traverse Motor

Model: Chairman

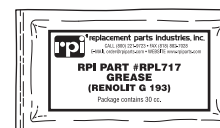

RPI Part #PCA747
OEM Part #007660

AUTO RECLINE ACTUATOR

- Nylon®
- Includes all parts as shown

Fits: Beam and Traverse Assembly
Model: Chairman

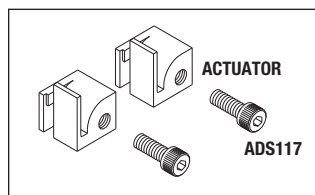

RPI Part #PCC728
OEM Part #9441643

LIFT CAPACITOR

- Electrolytic medium
- 53-64 µf; 220/250VAC
- Fits:** Base motor/lift motor
- Models:** Chairman 5000 & Coachman



RPI Part #PCC734
New OEM Part #7731904
Old OEM Part #019518

CAPACITOR

- Electrolytic medium
- 21-25 µf; 220/250VAC
- Fits:** Incline/recline and upper traverse
- Models:** Chairman 5000 & Coachman

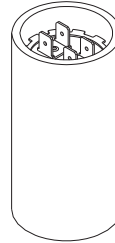

RPI Part #PCS731
OEM Part #1525737

CORRECTION LIMIT SWITCH

- 10A@125 VAC
- Fits:** Lift motor
- Model:** Chairman 5000

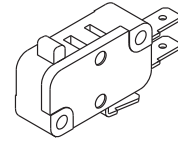

RPI Part #PCB730
OEM Part #040988

FOOT SWITCH ASSEMBLY (PCB)

- Includes all parts as shown
- Fits:** Foot switch assembly
- Models:** Chairman 5000 & 5010

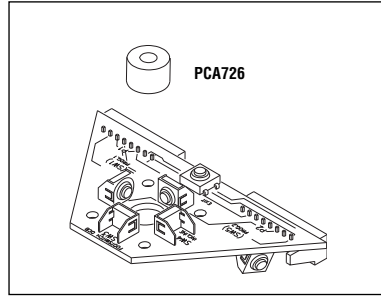

RPI Part #PCS735
OEM Part #7740947

AC POWER SWITCH

- 16A@125/250VAC
- Use only with 240V models
- Fits:** Inner base assembly
- Models:** Chairman 5000 (240VAC models only)

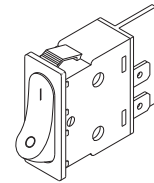

RPI Part #PCA726
OEM Part #5428292

ACTUATOR SPACER

- 4 per package
- Closed cell neoprene
- Fits:** Foot Switch Assembly (PCB)
- Models:** Chairman 5000 & 5010



RPI Part #PCB736
New OEM Part #9434424

UP INTERCONNECT (PCB)

- Fits:** Incline/recline controls
- Models:** Chairman 5000 & 5010

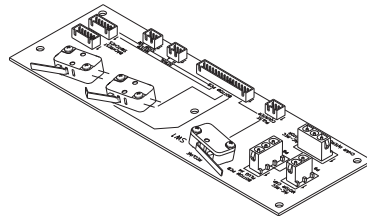

RPI Part #PCS717
OEM Part #007428

TILT SWITCH

- Momentary contact (On/Off/On)
- 6A@125VAC; 3A@250VAC
- Snap in mounting
- White paddle
- Fits:** Back assembly (Chairman) and Foot Switch Assembly (Chairman 5090)
- Model:** Chairman & Chairman 5090

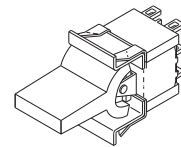

RPI Part #PCB733
New OEM Part #3006629

LIMIT SWITCH (PCB)

- Fits:** Incline/recline and upper traverse
- Models:** Chairman 5090

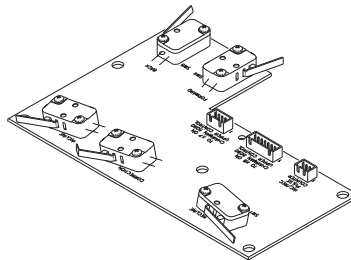

RPI Part #PCA737
OEM Part #1899702

FOOT SWITCH & CABLE ASSEMBLY

- Momentary contact (On/Off/On)
- 6A@125V; 3A@250V
- Snap in mounting
- White paddle
- Fits:** Inner base
- Models:** Chairman 5090

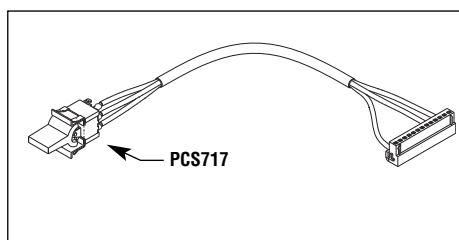

RPI Part #RPF367
OEM Part #1881163

FUSE (2A, 250VAC)

- 5 per package
- Size: 5 mm x 20 mm (.197" x .787")
- Glass, Fast-Acting
- Fits:** Inner base assembly (240V models only)
- Models:** Chairman 5000 & 5010

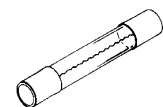

Dental Equipment

Models: Coachman & Coachman II

**RPI Part #PCC728
OEM Part #9441643**

LIFT CAPACITOR

- Electrolytic medium
 - 53-64 µf; 220/250VAC
- Fits:** Base motor/lift motor
Models: Chairman 5000 & Coachman

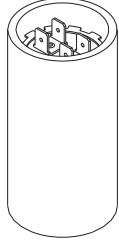

**RPI Part #PCC734
New OEM Part #7731904
Old OEM Part #019518**

CAPACITOR

- Electrolytic medium
 - 21-25 µf; 220/250VAC
- Fits:** Incline/recline and upper traverse
Models: Chairman 5000 & Coachman

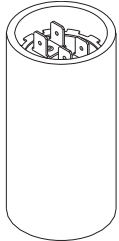

**RPI Part #PCB723
New OEM Part #018326**

SWITCH BACK PCB ASSEMBLY

- Fits:** Chair back assembly
Models: Coachman

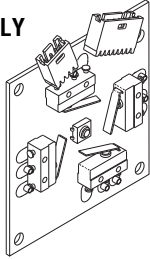

**RPI Part #PCS724
OEM Part #018420**

MICRO-SWITCH

- 5A@250VAC
- Fits:** Switch Back PCB Assembly
Model: Coachman

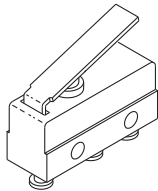

**RPI Part #PCS722
OEM Part #023944**

FOOT SWITCH MICRO-SWITCH

- 15A@125VAC
- Fits:** 4-way foot switch assembly
Models: Coachman & Coachman II

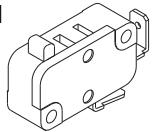

**RPI Part #PCS725
OEM Part #018956**

MOTOR LIMIT SWITCH

- 15A@120VAC
- Fits:** Base assembly
Models: Coachman & Coachman II

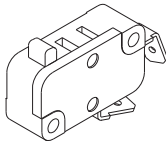

NOTES:

Air Techniques, Apollo/Midmark®, MDT McKesson, DentalEZ®/Custom Air/RamVac, Jun-Air, Matrx/Midmark®, Midmark®, Pelton & Crane, and Tech West/Turbine Ind.

LUBRICATED COMPRESSOR PM KITS TO FIT APOLLO/MIDMARK®

RPI Parts Included In PM Kits

RPI Part #	OEM Part #	Models	RPI Parts Included In PM Kits				
			Air Intake Filter Elements	Coalescing Filter Elements		Oil	Acc.
			CME004	CMK024	CMK025	CML001	RPB838
CMK173	ACA85407	ALCQL82/D	4		1	4	1
CMK160	ACA85402	ALCRL62/D	3		1	3	1
CMK167	ACA85400	ALCSL11/D, 12/D, 21/D, & 22/D	1	1		1	1
CMK159	ACA85401	ALCTL31/D, 32/D, 41/D & 42/D	2		1	2	1

Also Available! Syringe Pump/Extractor (RPI Part #RPT842), Drain Valve (RPI Part #RPV841), Bottle (1 Liter/32 fl. oz.) (RPI Part #RPB939), and Absorbant Pad (RPI Part #RPP958) - see page 430 for more information.

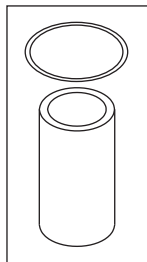

CME004

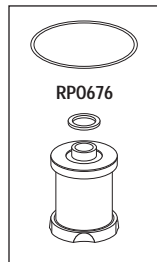

CMK024

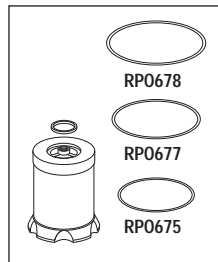

CMK025

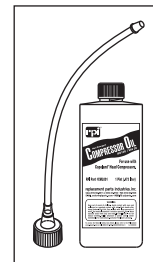

CML001

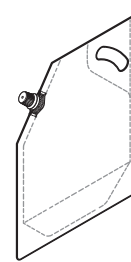

RPB838

It's the RPI Advantage! RPI PM Kits also include a PM Check List as well as a PM Sticker that can be attached to the compressor for recording the date that the filters and compressor oil were replaced.

LUBRICATED COMPRESSOR PM KITS TO FIT DENTALEZ®/CUSTOM AIR/RAMVAC

RPI Parts Included In PM Kits

RPI Part #	OEM Part #	Models	RPI Parts Included In PM Kits						
			Air Intake Filter Elements	Coalescing Filter Elements		Oil	Acc.		
			CMF073	CME104	CME105	CML119	RPB838	RP0848	CMG197
CMK152	65468176	CA-711 & 721	1	1	1	2	1	1	1
CMK153	65468177	CA-713 & 723	2	1	1	4	1	2	2
CMK154	65468178	CA-725	4	1	1	6	1	4	4

Also Available! Syringe Pump/Extractor (RPI Part #RPT842), Drain Valve (RPI Part #RPV841), Bottle (1 Liter/32 fl. oz.) (RPI Part #RPB939), and Absorbant Pad (RPI Part #RPP958) - see page 430 for more information.



CME104

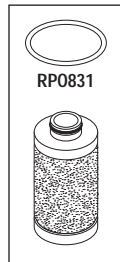

CME105

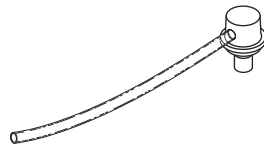

CMF073



CMG197

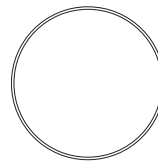

RP0848
Not Shown
Actual Size

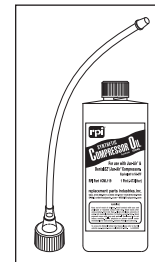

CML119

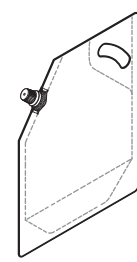

RPB838

It's the RPI Advantage! RPI PM Kits also include a PM Check List as well as a PM Sticker that can be attached to the compressor for recording the date that the filters and compressor oil were replaced.

NOTES: _____

Dental Equipment

Air Techniques, Apollo/Midmark®, MDT McKesson, DentalEZ®/Custom Air/RamVac, Jun-Air, MatrX/Midmark®, Midmark®, Pelton & Crane, and Tech West/Turbine Ind.

LUBRICATED COMPRESSOR PM KITS TO FIT MATRX/MIDMARK®

RPI Parts Included In PM Kits

RPI Part #	OEM Part #	Models	Air Intake Filter Elements		Coalescing Filter Elements	Oil	Acc.
			CME004	CMF013	CMF014	CMK024	CML001
MATRX/MIDMARK®							
CMK185	No OEM Part # Available	AMD-2 & 2-115		3		1	1
CMK186	No OEM Part # Available	AMD-4		3		1	2
CMK187	No OEM Part # Available	AMD-6		4		1	3
CMK167	77000958	AMD-100 & 101	1			1	1
CMK168	77000959	AMD-100-2	2			1	2
CMK169	77000960	AMD-100-3	3			1	3
CMK263	No OEM Part # Available	AMD-100 & AMD-102 (Manufactured before Midmark acquired MatrX)		3		1	1
CMK264	No OEM Part # Available	AMD-100-2 (Manufactured before Midmark acquired MatrX)		5		1	2
CMK265	No OEM Part # Available	AMD-100-3 (Manufactured before Midmark acquired MatrX)		6		1	3
CMK266	No OEM Part # Available	AC-075, AC-100 & AC-101		3			1
CMK267	No OEM Part # Available	AC-100-2		5			2
CMK268	No OEM Part # Available	ACD-075, ACD-100 & ACD-101			2	1	1
CMK269	No OEM Part # Available	ACD-100-2			4	1	2

Also Available! Syringe Pump/Extractor (RPI Part #RPT842), Drain Valve (RPI Part #RPV841), Bottle (1 Liter/32 fl. oz.) (RPI Part #RPB939), and Absorbant Pad (RPI Part #RPP958) - see page 430 for more information.

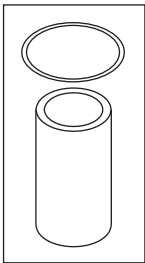

CME004

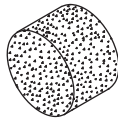

CMF013

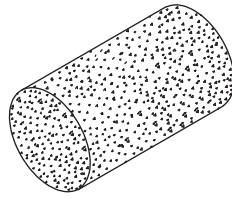

CMF014

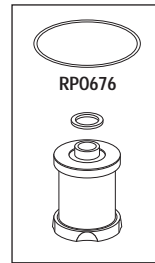

CMK024

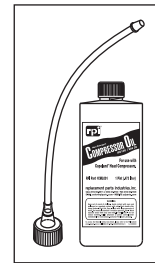

CML001

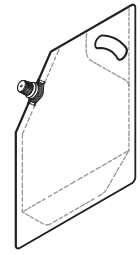

RPB838

It's the RPI Advantage! RPI PM Kits also include a PM Check List as well as a PM Sticker that can be attached to the compressor for recording the date that the filters and compressor oil were replaced.

LUBRICATED COMPRESSOR PM KITS TO FIT MIDMARK®

RPI Parts Included In PM Kits

RPI Part #	OEM Part #	Models	Air Intake Filter Elements		Coalescing Filter Elements	Oil	Acc.
			CME004		CMK025	CML001	RPB838
MIDMARK®							
CMK158	77001633	CL21 & CL22	1		1	1	1
CMK159	77001634	CL32	2		1	2	1
CMK160	77001635	CL52	3		1	3	1

Also Available! Syringe Pump/Extractor (RPI Part #RPT842), Drain Valve (RPI Part #RPV841), Bottle (1 Liter/32 fl. oz.) (RPI Part #RPB939), and Absorbant Pad (RPI Part #RPP958) - see page 430 for more information.

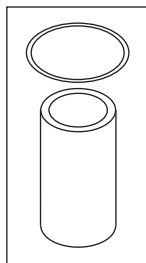

CME004

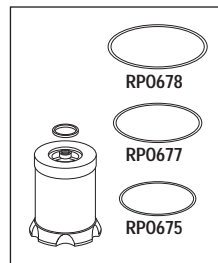

CMK025



CML001

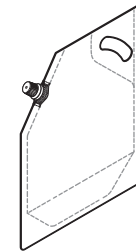

RPB838

It's the RPI Advantage! RPI PM Kits also include a PM Check List as well as a PM Sticker that can be attached to the compressor for recording the date that the filters and compressor oil were replaced.

FAX: (818) 882-7028 • E-MAIL: order@rpiarts.com • WEBSITE: www.rpiarts.com

Dental Equipment

Air Techniques, Apollo/Midmark®, MDT McKesson, DentalEZ®/Custom Air/RamVac, Jun-Air, Matrix/Midmark®, Midmark®, Pelton & Crane, and Tech West/Turbine Ind.

OIL-LESS COMPRESSOR PM KITS TO FIT AIR TECHNIQUES

RPI Part #	OEM Part #	Models	RPI Parts Included In PM Kits		
			Air Intake Filter Elements	Coalescing and Particulate Filter Elements	
			CMK065	CME102	CME103
AIR TECHNIQUES					
CMK141	87351	AirStar 10M, 10NEO & 12M	1	1	1
CMK142	87352	AirStar 21M, 21NEO, 22M, 22NEO, 30M & 30NEO	2	1	1
CMK199	87355	AirStar 40M & 40NEO	3	1	1
CMK143	87353	AirStar 50M & 50NEO	4	1	1
CMK144	87354	AirStar 70M & 70NEO	6	2	2
CMK278	87356	AirStar 100M	8	2	2

It's the RPI Advantage! RPI PM Kits also include a PM Check List as well as a PM Sticker that can be attached to the compressor for recording the date that the filters were replaced.

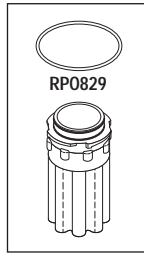

CME102

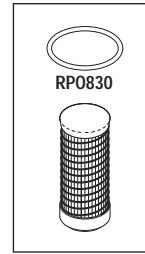

CME103

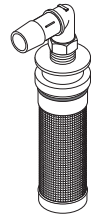

CMK065

OIL-LESS COMPRESSOR PM KITS TO FIT APOLLO/MIDMARK®

RPI Part #	OEM Part #	Models	RPI Parts Included In PM Kits						
			Air Intake Filter Elements			Coalescing and Particulate Filter Elements			Tip Seal Kit
			CME004	CME281	CME288	CME085	CMK024	CMK025	CMK287
APOLLO/MIDMARK®									
CMK170	ACA85403 & ACA85417	AOCOS11/D/DQ/Q, 12/D/DQ/Q, 21/D/DQ/Q, AOCOS22/D/DQ/Q, AOCRT21DQ/Q, AOCRT22DQ/Q & R22 (with 10 gal tank)	2				1		
CMK171	ACA85404	AOCOS31/D/DQ/Q, 32/D/DQ/Q, 42/D/DQ/Q, AOCOT32/D/DQ/Q & 42/D/DQ/Q	4					1	
CMK172	ACA85406	AOCOT62/D/DQ/Q & 82/D/DQ/Q	8					1	
CMK270	No OEM Part # Available	AOCRS11 & AOCRS12 (Manufactured before Apollo was acquired by Midmark)			1	1			
CMK271	No OEM Part # Available	AOCRS11 & AOCRS12 (Manufactured after Apollo was acquired by Midmark)	1			1			
CMK273	ACA85418	AOCRR42DQ, R42 & R22 (with 20, 30, or 40 gal tank)	3					1	
CMK274 ¹	ACA85415	AOCOS52, AOCOS52D		1				1	
CMK286 ¹	ACA85416	AOCOS52, AOCOS52D		1				1	1
CMK287	HPA30505	AOCOS52, AOCOS52D							1

Footnotes: ¹ This Kit only fits Compressors that have been upgraded with the RPI Air Intake Upgrade Kit (Round Style Housing) (RPI Part #CMK280), refer to page 423.

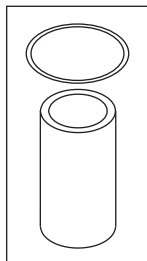

CME004

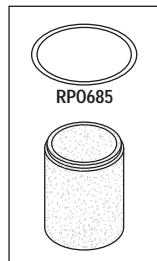

CME085

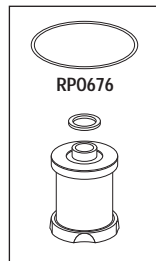

CMK024

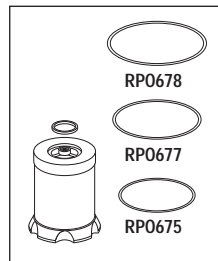

CMK025

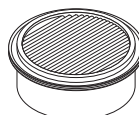

CME281

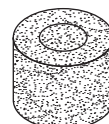

CME288

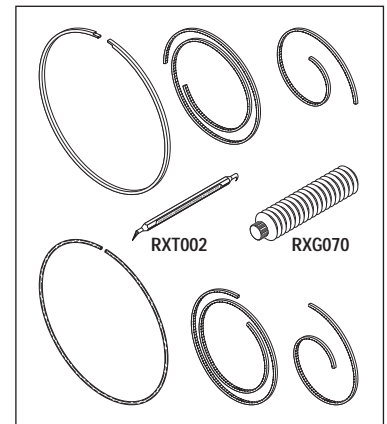

CMK287

It's the RPI Advantage! RPI PM Kits also include a PM Check List as well as a PM Sticker that can be attached to the compressor for recording the date that the filters were replaced.

OIL-LESS COMPRESSOR PM KITS TO FIT DENTALEZ®/CUSTOM AIR/JUN-AIR/RAMVAC

RPI Part #	OEM Part #	Models	RPI Parts Included In PM Kits								
			Air Intake Filter Elements				Coalescing and Particulate Filter Elements				
			CME067	CME074	CMF073	CMF075	CME043	CME044	CME105	CME107	CME227
DENTALEZ®/CUSTOM AIR/JUN-AIR/RAMVAC											
CMK076 ¹	004016	1013D, 1023D, 1025D & 1027D	2					1	1		
CMK092 ¹	004015	1022	1					1	1		
CMK101 ¹	004017	1029T	3					1	1		
CMK145	65468179	CA-812, 822, 912 & 922		1						2	
CMK146	65468180	CA-813-D & 823-D (SN 440537 and below)			2					2	
CMK147	65468186	CA-813/D, 823/D, 913 & 923 (SN 440538 - 631602)				4				2	
CMK191	004444	CA-813/D, 823/D, 913 & 923 (SN 631603 and above)				4				2	
CMK148	65468181	CA-825/D/O & 925/D (SN 631602 and below)		2						2	
CMK192	004445	CA-825/D/O & 925/D (SN 631603 and above)		2						2	
CMK149	65468182	CA-827-D & 927-D (SN 631602 and below)		3						2	
CMK193	004446	CA-827-D & 927-D (SN 631603 and above)		3						2	
CMK150	65468183	CA-829-D & 929-D (SN 631602 and below)		4						2	
CMK194	004449	CA-829-D & 929-D (SN 631603 and above)		4						2	
CMK151	65468184	CA-8212-T (SN 631602 and below)		6						2	
CMK195	004447	CA-8212-T (SN 631603 and above)		6						2	
CMK223	005147SP	Osprey 13, Osprey 22, & Osprey 23	2								1 1
CMK226	005350SP	Osprey 24	3								1 1
CMK224	005148SP	Osprey 25	4								1 1
CMK225	005149SP	Osprey 28	6								1 1

Footnotes: ¹ Fits only DentalEZ/Custom Air/RamVac Compressors

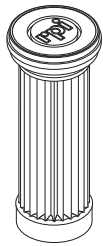

CME074

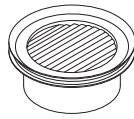

CME067



CMF073

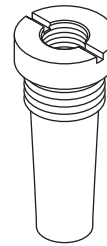

CMF075

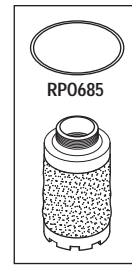

CME043

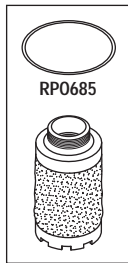

CME044

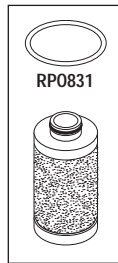

CME105

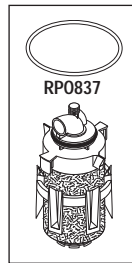

CME107

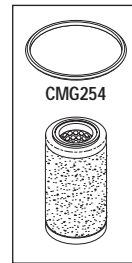

CME227

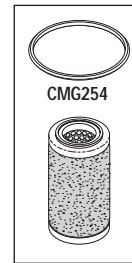

CME228

It's the RPI Advantage! RPI PM Kits also include a PM Check List as well as a PM Sticker that can be attached to the compressor for recording the date that the filters were replaced.

NOTES:

SECTION

4

PAGE

404

UPDATED

01/20

Dental Equipment

Air Techniques, Apollo/Midmark®, MDT McKesson, DentalEZ®/Custom Air/RamVac, Jun-Air, Matrx/Midmark®, Midmark®, Pelton & Crane, and Tech West/Turbine Ind.

OIL-LESS COMPRESSOR PM KITS TO FIT MATRX/MIDMARK®

RPI Parts Included In PM Kits

RPI Part #	OEM Part #	Models	Air Intake Filter Elements		Coalescing and Particulate Filter Elements
			CME071	CMF013	CMK024
MATRX/MIDMARK®					
CMK161	No OEM Part # Available	OL-100 & 101		3	1
CMK162	No OEM Part # Available	OL-100-2		5	1
CMK163	No OEM Part # Available	OL-100-3		6	1
CMK164	No OEM Part # Available	OL-3, 2000 & 2001	2		1
CMK165	No OEM Part # Available	OL-7 & 4000	4		1
CMK166	No OEM Part # Available	OL-10 & 6000	6		1

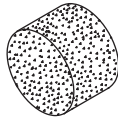

CMF013

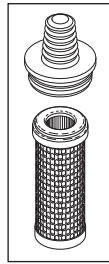

CME071

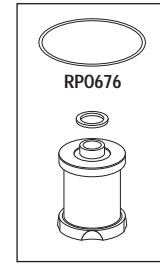

CMK024

It's the RPI Advantage! RPI PM Kits also include a PM Check List as well as a PM Sticker that can be attached to the compressor for recording the date that the filters were replaced.

OIL-LESS COMPRESSOR PM KITS TO FIT MIDMARK®

RPI Parts Included In PM Kits

RPI Part #	OEM Part #	Models	Air Intake Filter Elements			Coalescing and Particulate Filter Elements	Tip Seal Kit
			CME004	CME071	CME281	CMK025	CMK287
MIDMARK®							
CMK155	77001636	P21 & P22	2			1	
CMK198	77001636	P32	3			1	
CMK156	77001610	P52		4		1	
CMK157	77001611	P72		6		1	
CMK274 ¹	ACA85415	S52			1	1	
CMK286 ¹	ACA85416	S52			1	1	1
CMK287	HPA30505	S52					1

Footnotes: ¹ This Kit only fits Compressors that have been upgraded with the RPI Air Intake Upgrade Kit (Round Style Housing) (RPI Part #CMK280), refer to page 403.

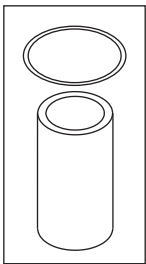

CME004

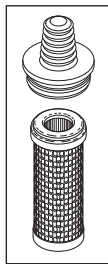

CME071

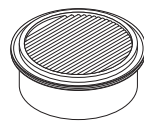

CME281

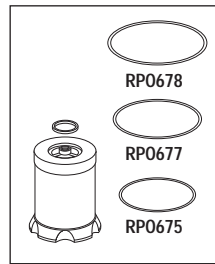

CMK025

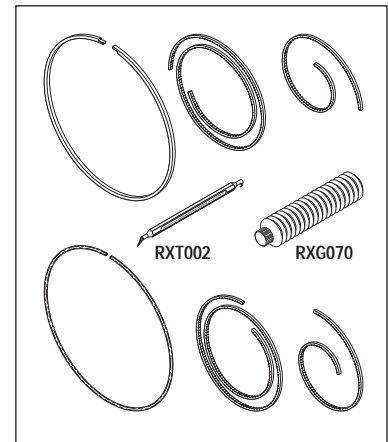

CMK287

It's the RPI Advantage! RPI PM Kits also include a PM Check List as well as a PM Sticker that can be attached to the compressor for recording the date that the filters were replaced.

Air Techniques, Apollo/Midmark®, MDT McKesson, DentalEZ®/Custom Air/RamVac, Jun-Air, Matrix/Midmark®, Midmark®, Pelton & Crane, and Tech West/Turbine Ind.

OIL-LESS COMPRESSOR PM KITS TO FIT TECH WEST

RPI Parts Included In PM Kits

RPI Part #	OEM Part #	Models	Air Intake Filter Elements		Coalescing and Particulate Filter Elements	
			CME067	CME069	CME110	CMK025
TECH WEST						
CMK174	CSKO-1	ACO2S1/ND & ACO2S2/ND (2005 and earlier)	2			1
CMK175	CSKO-1P	ACO2S1/ND & ACO2S2/ND (2006 and later)	2		1	
CMK176	CSKO-2	ACO4S2/ND & ACO4D2/ND (2005 and earlier)	4			1
CMK177	CSKO-2P	ACO4D2/ND (2006 and later)	4		1	
CMK178	CSKO-3	ACO6T2/ND (2005 and earlier)	6			1
CMK179	CSKO-3P	ACO6T2/ND (2006 and later)	6		1	
CMK275	No OEM Part # Available	ACOR2D1, ACOR2D1Q, ACOR2D2, ACOR2D2Q, ACOR3T2 & ACOR3T2Q	1		1	
CMK277	No OEM Part # Available	ACOR4Q2		1	1	

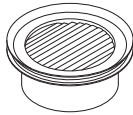

CME067



CME069

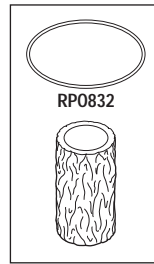

CME110

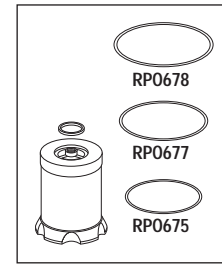

CMK025

It's the RPI Advantage! RPI PM Kits also include a PM Check List as well as a PM Sticker that can be attached to the compressor for recording the date that the filters were replaced.

NOTES:

Air Techniques, Apollo/Midmark®, MDT McKesson, DentalEZ®/Custom Air/RamVac, Jun-Air, Matrix/Midmark®, Midmark®, Pelton & Crane, and Tech West/Turbine Ind.

COALESCING FILTER ASSEMBLY (5 oz.) & REPLACEMENT PARTS

RPI PART #	DESCRIPTION	AIR TECHNIQUES	APOLLO/MIDMARK®	DENTAL EZ®/CUSTOM AIR/RAMVAC	JUN-AIR	MATRIX/MIDMARK®	MIDMARK®
CMA021	COALESCING FILTER ASSEMBLY (WILKERSON® Part #M16-03-FMO)	No OEM Part # Available	ACA70305			77005010	62985200
CMB087	MOUNTING BRACKET	No OEM Part # Available	No OEM Part # Available			No OEM Part # Available	No OEM Part # Available
CMC086	BLANK COVER	No OEM Part # Available	No OEM Part # Available	No OEM Part # Available	No OEM Part # Available	No OEM Part # Available	No OEM Part # Available
CMK005	COALESCING FILTER ELEMENT (WILKERSON® Part #MSP-95-988) • Type B, 0.5 micron		ACA86050 Type B, Wilkerson Filter only	648-00209 Type B, Wilkerson Filter only	648-00209 Type B, Wilkerson Filter only	77005005 Type B, Wilkerson Filter only	77005009 Type B, Wilkerson Filter only
CMK024	COALESCING FILTER ELEMENT (WILKERSON® Part #MTP-95-548) • Type C, 0.01 micron		ACA86050 Type C, Wilkerson Filter only	648-00209 Type C, Wilkerson Filter only	648-00209 Type C, Wilkerson Filter only	77005005 Type C, Wilkerson Filter only	77005009 Type C, Wilkerson Filter only
CMK026	COALESCING FILTER ELEMENT (GENERIC BRAND) • Type C, 0.01 micron		ACA86050 Type C, Generic Filter only	648-00209 Type C, Generic Filter only	648-00209 Type C, Generic Filter only	77005005 Type C, Generic Filter only	77005009 Type C, Generic Filter only
CMIO15	DIFFERENTIAL PRESSURE INDICATOR (WILKERSON® Part #DP2-01-000)		AAP85210			77002134	65907600
CMF016	AUTO DRAIN FLOAT (WILKERSON® Part #GRP-95-981)		ACA85210	645-45010 Wilkerson Auto Float Drain only			
RPF651	ADAPTOR FITTING		No OEM Part # Available	No OEM Part # Available			

RPI Part #CMA021

OEM Part #'s - See Chart Above

COALESCING FILTER ASSEMBLY (5 oz.)

- Wilkerson® (M16-03-FMO)
- Includes:
 - Adaptor Fitting (RPI Part #RPF651)
 - Auto Drain Float (RPI Part #CMF016)
 - Coalescing Filter Element (RPI Part #CMK024)
 - Differential Pressure Indicator (RPI Part #CMIO15)
 - PM sticker
- All parts also sold separately

It's the RPI Advantage! Also includes an attached PM Sticker for recording the date that the filter housing was replaced.

Also available:
Mounting Bracket
(RPI Part #CMB087)

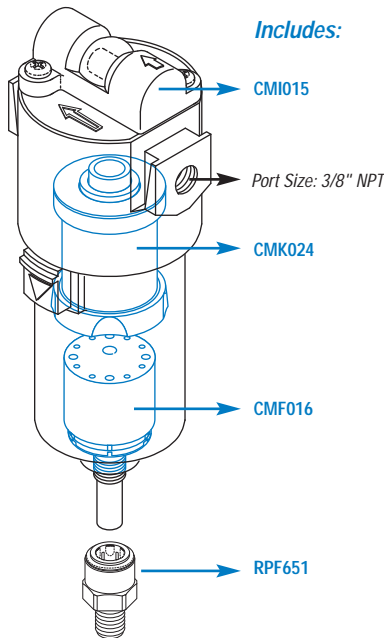
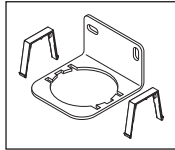

Includes:

RPI Part #CMK024

OEM Part #'s - See Chart Above

COALESCING FILTER ELEMENT

- Wilkerson® (MTP-95-548)
 - Size: 1.59" OD x 2.05" lg.
 - Type C; 0.01 micron
 - Includes all parts as shown and PM sticker
- Fits: Wilkerson® brand M16 (5 oz.) Series Filter Assembly



RPI Part #CMK026

OEM Part #'s - See Chart Above

COALESCING FILTER ELEMENT

- Generic brand
 - Size: 1.75" OD x 2.03" lg.
 - Type C; 0.01 micron
 - Includes all parts as shown and PM sticker
- Fits: Wilkerson® brand M16 (5 oz.) Series Filter Assembly



RPI Part #CMK005

OEM Part #'s - See Chart Above

COALESCING FILTER ELEMENT

- Wilkerson® (MSP-95-988)
 - Size: 1.59" OD x 2.05" lg.
 - Type B; 0.5 micron
 - Includes all parts as shown and PM sticker
- Fits: Wilkerson® brand M16 (5 oz.) Series Filter Assembly



RPI Part #CMC086

OEM Part #'s - See Chart Above

BLANK COVER

- Wilkerson® brand
 - Black plastic
 - Includes all parts as shown
 - Replaces Differential Pressure Indicator (RPI Part #CMIO15)
- Fits: Wilkerson® brand M16 (5 oz.) & M26 (10 oz.) Series Filter Assembly

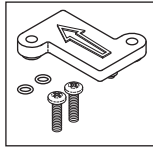

RPI Part #CMIO15

OEM Part #'s - See Chart Above

DIFFERENTIAL PRESSURE INDICATOR

- Wilkerson® brand
 - Includes: screws and O-rings
 - Also available: Coalescing Filter Assembly (RPI Part #'s CMA021 & CMA022)
- Fits: Wilkerson® brand M16 (5 oz.) & M26 (10 oz.) Series Filter Assembly

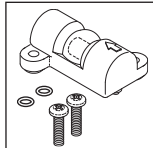

RPI Part #CMF016

OEM Part #'s - See Chart Above

AUTO DRAIN FLOAT

- Wilkerson® brand
 - Includes: O-ring, nut and Adaptor Fitting (RPI Part #RPF651)
 - Also available: Coalescing Filter Assembly (RPI Part #'s CMA021 & CMA022)
- Fits: Wilkerson® brand M16 (5 oz.) & M26 (10 oz.) Series Filter Assembly

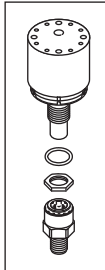

RPI Part #RPF651

OEM Part #'s - See Chart Above

ADAPTOR FITTING (3/8" TUBE X 1/8" MPT)

- Material: Acetal
- Fits: Wilkerson® brand M16 (5 oz.) & M26 (10 oz.) Series Filter Assembly



RPI Part #CMB087

OEM Part #'s - See Chart Above

MOUNTING BRACKET

- Wilkerson® brand
- "L" type bracket; Wall mount
- Use this bracket to externally mount the Coalescing Filter Assembly to the wall. *It's the RPI Advantage!*

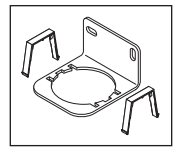

Fits: Wilkerson® brand F16 & M16 (5 oz.) Series Coalescing Filter Assemblies

COALESCING FILTER ASSEMBLY (10 oz.) & REPLACEMENT PARTS

RPI PART #	DESCRIPTION	AIR TECHNIQUES	APOLLO/MIDMARK®	DENTAL EZ®/CUSTOM AIR/RAMVAC	JUN-AIR	MATRX/MIDMARK®	MIDMARK®	TECH WEST
CMA022	COALESCING FILTER ASSEMBLY (WILKERSON® Part #M26-03-FMO)	No OEM Part # Available	ACA85215	645-45010	JA4081500			CFA-375
CMB088	MOUNTING BRACKET	No OEM Part # Available	No OEM Part # Available			No OEM Part # Available	No OEM Part # Available	
CMC086	BLANK COVER	No OEM Part # Available	No OEM Part # Available	No OEM Part # Available	No OEM Part # Available	No OEM Part # Available	No OEM Part # Available	No OEM Part # Available
CMF016	AUTO DRAIN FLOAT (WILKERSON® Part #GRP-95-981)		ACA85210	645-45010 Wilkinson Auto Float Drain only				
CMK006	COALESCING FILTER ELEMENT (WILKERSON® Part #MSP-95-989) • Type B, 0.5 micron		ACA86055 Type B, Wilkerson Filter only	645-45010 Type B, Wilkerson Filter only	JA4081500 Type B, Wilkerson Filter only		77005002	CFE-375 Type B, Wilkerson Filter only
CMK025	COALESCING FILTER ELEMENT (WILKERSON® Part #MTP-95-549) • Type C, 0.01 micron		ACA86055 Type C, Wilkerson Filter only	645-45010 Type C, Wilkerson Filter only	JA4081500 Type C, Wilkerson Filter only			CFE-375 Type C, Wilkerson Filter only
CMK027	COALESCING FILTER ELEMENT (GENERIC BRAND) • Type C, 0.01 micron		ACA86055 Type C, Generic Filter only	645-45010 Type C, Generic Filter only	JA4081500 Type C, Generic Filter only			CFE-375 Type C, Generic Filter only
CMIO15	DIFFERENTIAL PRESSURE INDICATOR (WILKERSON® Part #DP2-01-000)		AAP85210			77002134	65907600	CI-100
RPF651	ADAPTOR FITTING		No OEM Part # Available	No OEM Part # Available				

RPI Part #CMA022
OEM Part #'s - See Chart Above

COALESCING FILTER ASSEMBLY (10 oz.)

- Wilkerson® (M26-03-FMO)
- Includes:
 - Adaptor Fitting (RPI Part #RPF651)
 - Auto Drain Float (RPI Part #CMF016)
 - Coalescing Filter Element (RPI Part #CMK025)
 - Differential Pressure Indicator (RPI Part #CMIO15)
 - PM sticker
- All parts also sold separately

It's the RPI Advantage! Also includes an attached PM Sticker for recording the date that the filter housing was replaced.

Also available:
Mounting Bracket
(RPI Part #CMB088)

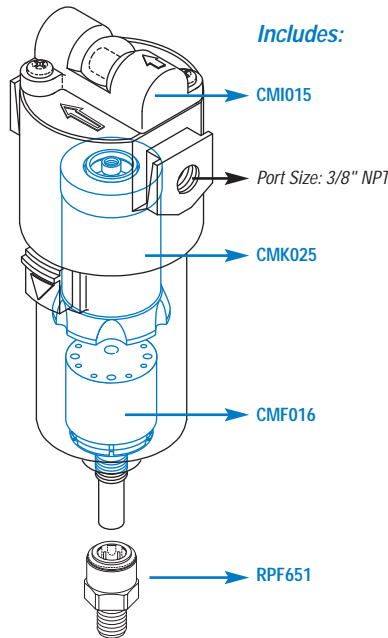
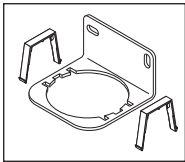

Includes:

RPI Part #CMK025
OEM Part #'s - See Chart Above

COALESCING FILTER ELEMENT

- Wilkerson® (MTP-95-549)
- Size: 1.89" OD x 2.80" lg.
- Type C; 0.01 micron
- Includes all parts as shown and PM sticker
- Fits: Wilkerson® brand M26 (10 oz.) Series Filter Assembly

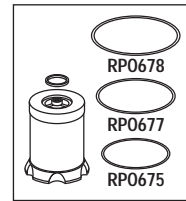

RPI Part #CMK027
OEM Part #'s - See Chart Above

COALESCING FILTER ELEMENT

- Generic brand
- Size: 1.75" OD x 2.75" lg.
- Type C; 0.01 micron
- Includes all parts as shown and PM sticker
- Fits: Wilkerson® brand M26 (10 oz.) Series Filter Assembly

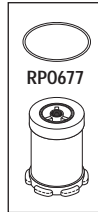

RPI Part #CMK006
OEM Part #'s - See Chart Above

COALESCING FILTER ELEMENT

- Wilkerson® (MSP-95-989)
- Size: 1.89" OD x 2.82" lg.
- Type B; 0.5 micron
- Includes: Filter Element, Seal, Bowl O-ring (RPI Part #RP0677), PM sticker, and 1 additional Bowl O-ring (RPI Part #RP0675)
- Fits: Wilkerson® brand M26 (10 oz.) Series Filter Assembly



RPI Part #CMC086
OEM Part #'s - See Chart Above

BLANK COVER

- Wilkerson® brand
- Black plastic
- Includes all parts as shown
- Replaces Differential Pressure Indicator (RPI Part #CMIO15)
- Fits: Wilkerson® brand M16 (5 oz.) & M26 (10 oz.) Series Filter Assembly

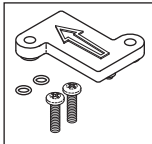

RPI Part #CMIO15
OEM Part #'s - See Chart Above

DIFFERENTIAL PRESSURE INDICATOR

- Wilkerson® brand
- Includes: screws and O-rings
- Also available: Coalescing Filter Assembly (RPI Part #'s CMA021 & CMA022)
- Fits: Wilkerson® brand M16 (5 oz.) & M26 (10 oz.) Series Filter Assembly

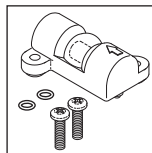

RPI Part #CMF016
OEM Part #'s - See Chart Above

AUTO DRAIN FLOAT

- Wilkerson® brand
- Includes: O-ring, nut and Adaptor Fitting (RPI Part #RPF651)
- Also available: Coalescing Filter Assembly (RPI Part #'s CMA021 & CMA022)
- Fits: Wilkerson® brand M16 (5 oz.) & M26 (10 oz.) Series Filter Assembly

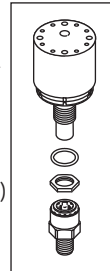

RPI Part #RPF651
OEM Part #'s - See Chart Above

ADAPTOR FITTING (3/8" TUBE X 1/8" MPT)

- Material: Acetal
- Fits: Wilkerson® brand M16 (5 oz.) & M26 (10 oz.) Series Filter Assembly



RPI Part #CMB088
OEM Part #'s - See Chart Above

MOUNTING BRACKET

- Wilkerson® brand
- "L" type bracket; Wall mount
- Use this bracket to externally mount the Coalescing Filter Assembly to the wall.
- It's the RPI Advantage!*
- Fits: Wilkerson® brand F26 & M26 (10 oz.) Series Coalescing Filter Assemblies

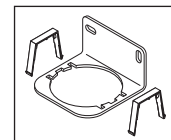

Air Techniques, Apollo/Midmark®, MDT McKesson, DentalEZ®/Custom Air/RamVac, Jun-Air, Matrix/Midmark®, Midmark®, Pelton & Crane, and Tech West/Turbine Ind.

COALESCING FILTER ASSEMBLY & REPLACEMENT PARTS

RPI PART #	DESCRIPTION	DENTALEZ®/ CUSTOM AIR/RAMVAC
CMA229	COALESCING FILTER ASSEMBLY	004960
CMB232	BOWL GASKET (AUTO DRAIN)	No OEM Part # Available
CMB262	MOUNTING BRACKET	No OEM Part # Available
CME227	COALESCING FILTER ELEMENT	005150
CMG254	BOWL GASKET	No OEM Part # Available
CM1231	DIFFERENTIAL PRESSURE INDICATOR	No OEM Part # Available

RPI Part #CMA229

OEM Part #'s - See Chart Above

COALESCING FILTER ASSEMBLY

- SMC® brand
- Includes:
 - Bowl (Auto Drain) (RPI Part #CMB232)
 - Coalescing Filter Element (RPI Part #CME227)
 - Differential Pressure Indicator (RPI Part #CM1231)
 - PM sticker
- **All parts also sold separately**

Fits: Dryer Assembly

It's the RPI Advantage! Also includes an attached PM Sticker for recording the date that the filter housing was replaced.

Also available:
Mounting Bracket
(RPI Part #CMB262)

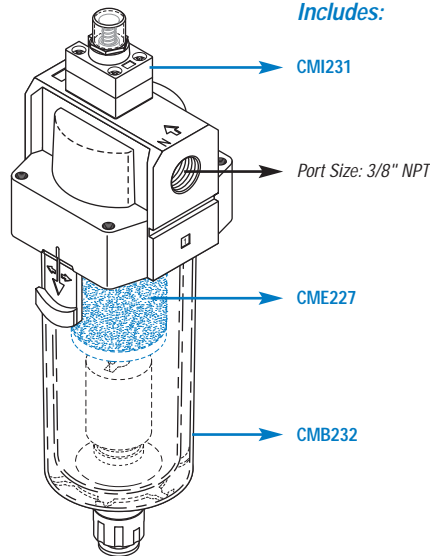
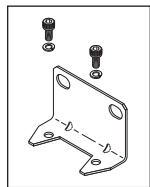

Includes:

RPI Part #CME227

OEM Part #'s - See Chart Above

COALESCING FILTER ELEMENT

- SMC® brand
- Size: 1.45" dia. x 2.78" lg.
- 0.30 Micron filter material
- Includes all parts as shown

Fits: Coalescing Filter Assembly

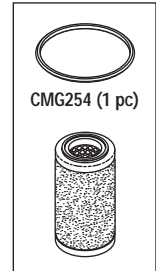

RPI Part #CMB232

OEM Part #'s - See Chart Above

BOWL (AUTO DRAIN)

- SMC® brand
- Includes: Float assembly, auto drain, and (1 pc) Bowl Gasket (RPI Part #CMG254)

Fits: Coalescing Filter Assembly

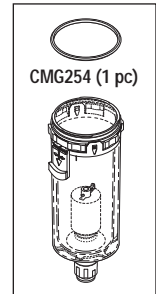

RPI Part #CM1231

OEM Part #'s - See Chart Above

DIFFERENTIAL PRESSURE INDICATOR

- SMC® brand
- Includes: Gasket and mounting screws

Fits: Coalescing Filter Assembly and Particulate Filter Assembly

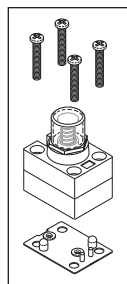

RPI Part #CMG254

OEM Part #'s - See Chart Above

BOWL GASKET

- SMC® brand
- 3 per package
- Size: 2.200" ID x 2.400" OD x .100" SQ. C/S

Fits: Dryer Assembly, Coalescing Filter Assembly and Particulate Filter Assembly

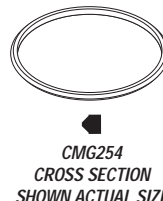

RPI Part #CMB262

OEM Part #'s - See Chart Above

MOUNTING BRACKET

- SMC® brand
 - Includes: Mounting screws (M5 x 10)
 - Use this bracket to externally mount the Coalescing Filter Assembly to the wall.
- It's the RPI Advantage!*

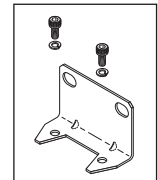

PARTICLE FILTER ASSEMBLIES & REPLACEMENT PARTS

RPI PART #	DESCRIPTION	AIR TECHNIQUES
CMA082	PARTICLE FILTER ASSEMBLY (Norgren® Brand F73) Assembly includes Particle Filter Element (RPI Part #CME083)	85617
CMA084	PARTICLE FILTER ASSEMBLY (Wilkerson® Brand F18) Assembly includes Particle Filter Element (RPI Part #CME085)	86197
CMB099	MOUNTING BRACKET (fits Norgren® Brand F73 style Filter Assys)	No OEM Part # Available
CMB100	MOUNTING BRACKET (fits Wilkerson® Brand F18 style Filter Assys)	No OEM Part # Available
CME083	PARTICLE FILTER ELEMENT (fits Norgren® Brand F73 style Filter Assys) Replacement filter (5 micron) and bowl o-ring to fit Particle Filter Assembly (RPI Part #CMA082)	85602
CME085	PARTICLE FILTER ELEMENT (fits Wilkerson® Brand F18 style Filter Assys) Replacement filter (5 micron) and bowl o-ring to fit Particle Filter Assembly (RPI Part #CMA084)	86193
CM1095	DIFFERENTIAL PRESSURE INDICATOR (Wilkerson® Brand F18) Replacement Differential Pressure Indicator to fit Particle Filter Assembly (RPI Part #CMA084)	86192
CM1096	DIFFERENTIAL PRESSURE INDICATOR (Norgren® Brand F73) Replacement Differential Pressure Indicator to fit Particle Filter Assembly (RPI Part #CMA082)	86192

RPI Part #CMA082
OEM Part #'s - See Chart Above

NORGREN® BRAND

PARTICLE FILTER ASSEMBLY

- Norgren® (F73 Series)
 - Includes:
 - Differential Pressure Indicator (RPI Part #CM1096)
 - Particle Filter Element (RPI Part #CME083)
 - PM sticker
 - **All parts also sold separately**
- Models: All Air Techniques

It's the RPI Advantage!
Also includes a PM Sticker that can be attached to the filter housing or compressor for recording the date that the filter was replaced.

Also available:
Mounting Bracket (RPI Part #CMB099)

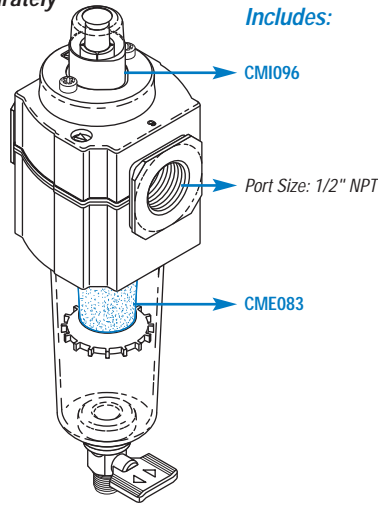

RPI Part #CME083
OEM Part #'s - See Chart Above

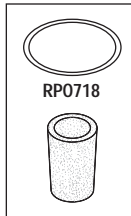

PARTICLE FILTER ELEMENT

- Norgren® brand
- Size: .93" OD x 1.44" lg.
- 5 micron filter element
- Includes all parts as shown, and PM Sticker
- Also available: Particle Filter Assembly (RPI Part #CMA082)

Fits: Norgren® brand F73 Series Particle Filter Assembly
Models: All Air Techniques

RPI Part #CM1096
OEM Part #'s - See Chart Above

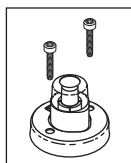

DIFFERENTIAL PRESSURE INDICATOR

- Norgren® brand
- Includes: Mounting screws
- Also available: Particle Filter Assembly (RPI Part #CMA082)

Fits: Norgren® brand F73 Series Particle Filter Assembly
Models: All Air Techniques

RPI Part #CMA084
OEM Part #'s - See Chart Above

WILKERSON® BRAND

PARTICLE FILTER ASSEMBLY

- Wilkerson® (F18 Series)
 - Includes:
 - Differential Pressure Indicator (RPI Part #CM1095)
 - Particle Filter Element (RPI Part #CME085)
 - PM sticker
 - **All parts also sold separately**
- Models: All Air Techniques

It's the RPI Advantage!
Also includes an attached PM Sticker for recording the date that the filter housing was replaced.

Also available:
Mounting Bracket (RPI Part #CMB100)

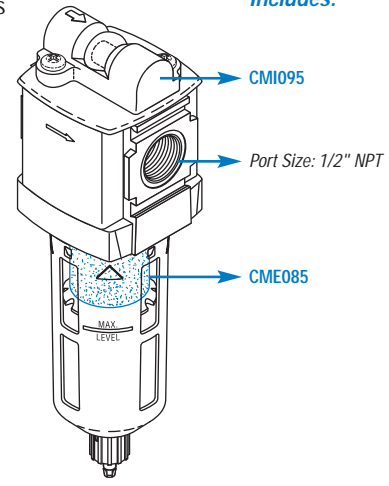

RPI Part #CME085
OEM Part #'s - See Chart Above

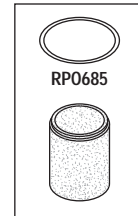

PARTICLE FILTER ELEMENT

- Wilkerson® brand
- Size: 1.30" OD x 1.62" lg.
- 5 micron filter element
- Includes all parts as shown, and PM Sticker
- Also available: Particle Filter Assembly (RPI Part #CMA084)

Fits: Wilkerson® brand B18, F18 & M18 Series Particle Filter Assembly
Models: All Air Techniques

RPI Part #CM1095
OEM Part #'s - See Chart Above

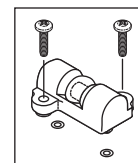

DIFFERENTIAL PRESSURE INDICATOR

- Wilkerson® brand
- Includes: Mounting screws and O-rings
- Also available: Particle Filter Assembly (RPI Part #CMA084)

Fits: Wilkerson® brand B18, F18 & M18 Series Particle Filter Assembly
Models: All Air Techniques

Air Techniques, Apollo/Midmark®, MDT McKesson, DentalEZ®/Custom Air/RamVac, Jun-Air, Matrix/Midmark®, Midmark®, Pelton & Crane, and Tech West/Turbine Ind.

PARTICULATE FILTER ASSEMBLY & REPLACEMENT PARTS

RPI PART #	DESCRIPTION	DENTAL EZ® / CUSTOM AIR/RAMVAC
CMA230	PARTICULATE FILTER ASSEMBLY	004961
CMB233	BOWL (MANUAL DRAIN)	No OEM Part # Available
CMB262	MOUNTING BRACKET	No OEM Part # Available
CME228	PARTICULATE FILTER ELEMENT	005151
CMG254	BOWL GASKET	No OEM Part # Available
CMI231	DIFFERENTIAL PRESSURE INDICATOR	No OEM Part # Available

RPI Part #CMA230

OEM Part #'s - See Chart Above

PARTICULATE FILTER ASSEMBLY

- SMC® brand
- Includes:
 - Bowl (Manual Drain) (RPI Part #CMB233)
 - Particulate Filter Element (RPI Part #CME228)
 - Differential Pressure Indicator (RPI Part #CMI231)
 - PM sticker

• **All parts also sold separately**

Fits: Dryer Assembly

It's the RPI Advantage!
Also includes an attached PM Sticker for recording the date that the filter housing was replaced.

Also available:
Mounting Bracket
(RPI Part #CMB262)

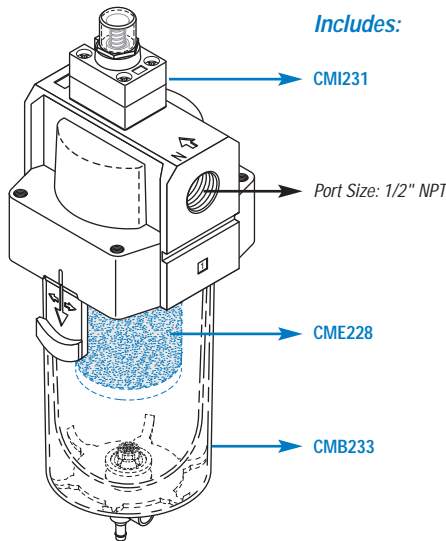
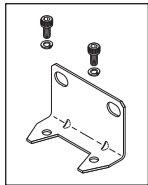

Includes:

RPI Part #CME228

OEM Part #'s - See Chart Above

PARTICULATE FILTER ELEMENT

- SMC® brand
- 0.01 Micron filter material
- Includes all parts as shown

Fits: Particulate Filter Assembly

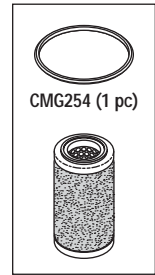

RPI Part #CMB233

OEM Part #'s - See Chart Above

BOWL (MANUAL DRAIN)

- SMC® brand
- Includes: Float assembly, manual drain, and (1 pc) Bowl Gasket (RPI Part #CMG254)

Fits: Particulate Filter Assembly

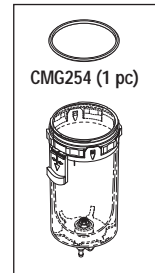

RPI Part #CMI231

OEM Part #'s - See Chart Above

DIFFERENTIAL PRESSURE INDICATOR

- SMC® brand
- Includes: Gasket and mounting screws

Fits: Coalescing Filter Assembly and Particulate Filter Assembly

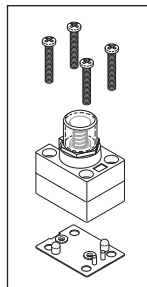

RPI Part #CMG254

OEM Part #'s - See Chart Above

BOWL GASKET

- SMC® brand
- 3 per package
- Size: 2.200" ID x 2.400" OD x .100" SQ. C/S

Fits: Dryer Assembly, Coalescing Filter Assembly and Particulate Filter Assembly

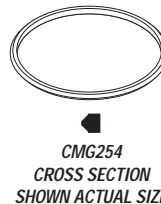

RPI Part #CMB262

OEM Part #'s - See Chart Above

MOUNTING BRACKET

- SMC® brand
- Includes: Mounting screws (M5 x 10)
- Use this bracket to externally mount the Particulate Filter Assembly to the wall.

It's the RPI Advantage!

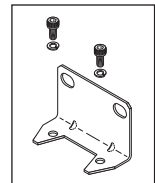

AUTO DRAINS AND FLOATS, BOWLS (AUTO & MANUAL DRAIN) & MOUNTING BRACKETS

RPI PART #	DESCRIPTION	AIR TECHNIQUES	APOLLO/ MIDMARK®	DENTAL EZ®/ CUSTOM AIR/RAMVAC	JUN-AIR	MATRX/ MIDMARK®	MIDMARK®	TECH WEST
CMB087	MOUNTING BRACKET • Fits Wilkerson® (F16 & M16 Coalescing Assemblies)	No OEM Part # Available	No OEM Part # Available			No OEM Part # Available	No OEM Part # Available	
CMB088	MOUNTING BRACKET • Fits Wilkerson® (F26 & M26 Coalescing Assemblies)	No OEM Part # Available	No OEM Part # Available			No OEM Part # Available	No OEM Part # Available	
CMB099	MOUNTING BRACKET • Fits Norgren® brand (F73 Particle Filter Assembly)	No OEM Part # Available						
CMB100	MOUNTING BRACKET • Fits Wilkerson® (B18, F18 & M18 Particle Filter Assemblies)	No OEM Part # Available						
CMB262	MOUNTING BRACKET • SMC® brand			No OEM Part # Available				
CMB232	BOWL (AUTO DRAIN)			No OEM Part # Available				
CMB233	BOWL (MANUAL DRAIN)			No OEM Part # Available				
CMD108	AUTO DRAIN FLOAT • Parker Balston® brand			JA4087602	No OEM Part # Available			
CMD111	AUTO DRAIN FLOAT • Parker Balston® brand							No OEM Part # Available
CMF016	AUTO DRAIN FLOAT Fits Wilkerson® (GRP-95-981)		ACA85210	645-45010 Wilkerson® Auto Float Drain only				

RPI Part #CMF016
OEM Part #'s - See Chart Above

- AUTO DRAIN FLOAT**
- Wilkerson® brand
 - Also available: Coalescing Filter Assembly (RPI Part #'s CMA021 & CMA022)
 - Includes: O-ring, nut and Adaptor Fitting (RPI Part #RPF651)

Fits: Wilkerson® brand M16 (5 oz.) & M26 (10 oz.) Series Filter Assembly

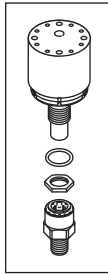

RPI Part #CMB233
OEM Part #'s - See Chart Above

- BOWL (MANUAL DRAIN)**
- SMC® brand
 - Includes all parts as shown
 - Also available: Particulate Filter Assembly (RPI Part #CMA230)

Fits: Particulate Filter Assembly

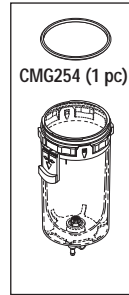

RPI Part #CMB088
OEM Part #'s - See Chart Above

- MOUNTING BRACKET**
- Wilkerson® brand
 - Wall mounting bracket
 - Black powder coated steel
 - Includes all parts as shown

Fits: Wilkerson® brand F26 & M26 Series Coalescing Filter Assemblies

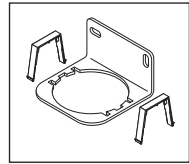

RPI Part #CMB099
OEM Part #'s - See Chart Above

- MOUNTING BRACKET**
- Norgren® brand
 - Wall mounting bracket
 - Black powder coated steel
 - Includes all parts as shown

Fits: Norgren® brand F73 Series Particle Filter Assembly

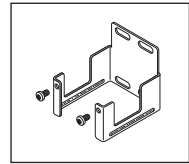

RPI Part #CMD108
OEM Part #'s - See Chart Above

- AUTO-DRAIN FLOAT**
- Parker-Balston® brand
 - Includes all parts as shown
 - Also available: Bowl O-Ring (RPI Part #RP0837)

Fits: "D" Style Absorption Dryer Assembly (Replacement Auto-Drain to fit "D" style Absorption Dryer Assembly, Coalescing Filter Assembly (Jun-Air Part #4081502))

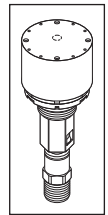

RPI Part #CMB232
OEM Part #'s - See Chart Above

- BOWL (AUTO DRAIN)**
- SMC® brand
 - Includes all parts as shown
 - Also available: Coalescing Filter Assembly (RPI Part #CMA229)

Fits: Coalescing Filter Assembly

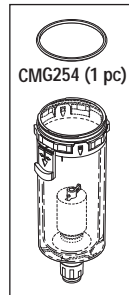

RPI Part #CMB100
OEM Part #'s - See Chart Above

- MOUNTING BRACKET**
- Wilkerson® brand
 - Wall mounting bracket
 - Black powder coated steel
 - Includes all parts as shown

Fits: Wilkerson® brand B18, F18 & M18 Series Particle Filter Assembly

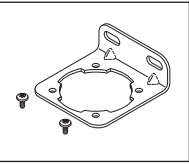

RPI Part #CMD111
OEM Part #'s - See Chart Above

- AUTO-DRAIN FLOAT**
- Parker-Balston® brand
 - Includes all parts as shown
 - Also available: Adaptor Fitting (RPI Part #RPF651) and Bowl O-Ring (RPI Part #RP0832)

Fits: Coalescing Filter Assembly (Tech West Part #CFA0-375)

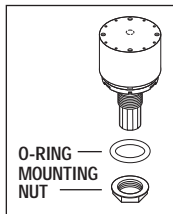

RPI Part #CMB087
OEM Part #'s - See Chart Above

- MOUNTING BRACKET**
- Wilkerson® brand
 - Wall mounting bracket
 - Black powder coated steel
 - Includes all parts as shown

Fits: Wilkerson® brand F16 & M16 Series Coalescing Filter Assemblies

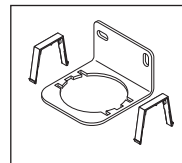

RPI Part #CMB262
OEM Part #'s - See Chart Above

- MOUNTING BRACKET**
- SMC® brand
 - Wall mounting bracket
 - Includes all parts as shown

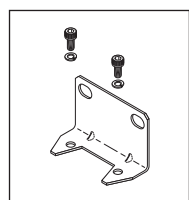

Air Techniques, Apollo/Midmark®, MDT McKesson, DentalEZ®/Custom Air/RamVac, Jun-Air, Matrix/Midmark®, Midmark®, Pelton & Crane, and Tech West/Turbine Ind.

BELTS AND BELT TOOL

RPI PART #	DESCRIPTION	APOLLO/ MIDMARK®	MIDMARK®	PELTON & CRANE
CMB279	DRIVE BELT	MMS73500	MMS73500	
PCB608	PERCHERON DRIVE BELT			006167
PCB609	WINDMILL BELT			006477
PCB610	WINDMILL BELT			011041
RPT954	BELT TENSIONER TESTER	No OEM Part # Available	No OEM Part # Available	No OEM Part # Available



Fits Scroll Style
Compressors

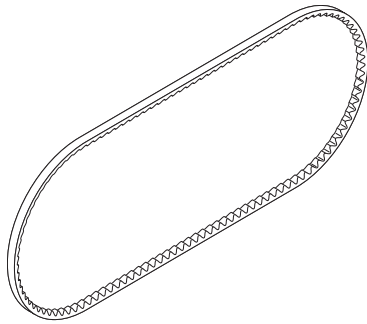

RPI Part #CMB279
OEM Part #'s - See Chart Above

DRIVE BELT

- V-Belt (3VX450)
- Effective belt length: 45.0"
- Size: .37" at top x .31" thk
- Diameter: 14.42" OD

Fits: Compressor Pulley



CMB279
CROSS SECTION
SHOWN ACTUAL SIZE



RPI Part #PCB609
OEM Part #'s - See Chart Above

WINDMILL BELT

- V-Belt (7M690)
- Effective belt length: 27.17"
- Size: .31" at top x .22" thk
- Diameter: 8.67" OD

Fits: Compressor Pulley



PCB609
CROSS SECTION
SHOWN ACTUAL SIZE

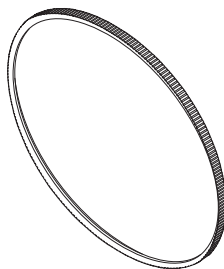

RPI Part #PCB608
OEM Part #'s - See Chart Above

PERCHERON DRIVE BELT

- V-Belt (7M900)
- Effective belt length: 35.43"
- Size: .31" at top x .22" thk
- Diameter: 11.31" OD

Fits: Compressor Pulley



PCB608
CROSS SECTION
SHOWN ACTUAL SIZE



RPI Part #PCB610
OEM Part #'s - See Chart Above

WINDMILL BELT

- V-Belt (7M730)
- Effective belt length: 28.74"
- Size: .31" at top x .22" thk
- Diameter: 9.21" OD

Fits: Compressor Pulley



PCB610
CROSS SECTION
SHOWN ACTUAL SIZE

RPI Part #RPT954
OEM Part #'s - See Chart Above

BELT TENSIONER TESTER

- Range: 0-35 lbs. (0-15.9 kg) with a span of up to 170" lg. or belt deflection of up to 2.75"
- Includes: Pocket clip and clear storage tube
- Also available: O-Ring (RPI Part #RPO302) and O-Ring (RPI Part #RPO315)

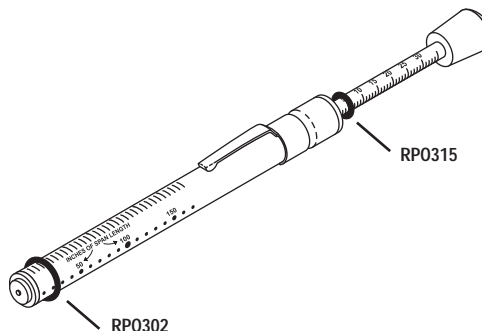

This Belt Tension Tester measures the belt tension of most "V" belts. Consult the OEM or the belt manufacturer for the recommended belt tension for each drive system.

CAPACITORS

RPI PART #	DESCRIPTION	AIR TECHNIQUES	APOLLO/MIDMARK®	DENTALEZ®/CUSTOM AIR/RAMVAC	MATRX/MIDMARK®	MIDMARK®	PELTON & CRANE	TECH WEST
CMC030	CAPACITOR (145-174µf, 250VAC)	64502	HCA30625		Included in 77001344 & 77001346	Included in 77001344 & 77001346		SCC-230
CMC031	CAPACITOR (20µf, 440VAC)	66516	HCA30622		Included in 77001346	Included in 77001346		RCC-208
CMC034	CAPACITOR (10µf, 370VAC)			Included in 645011011	Included in 77001344	Included in 77001344		
CMC036	CAPACITOR (430-516µf, 115VAC)	62502	HCA30628		Included in 77001345	Included in 77001345		SCC-115
CMC037	CAPACITOR (40µf, 370VAC)	62503	HCA30620	Included in 645011010	Included in 77001346	Included in 77001346		RCC-115
CMC042	CAPACITOR (540-648µf, 115VAC)	60502	HCA30626					
CMC201	CAPACITOR (65µf, 370VAC)	85833						
CMC202	CAPACITOR (55µf, 370VAC)	85832						
CMC203	CAPACITOR (27.5µf, 370VAC)	85831						
CMC243	CAPACITOR (460-552µf, 125VAC)	80175						
PCC636	CAPACITOR (590-708µf, 110/125VAC)						005107	

RPI Part #CMC030
OEM Part #'s - See Chart Above

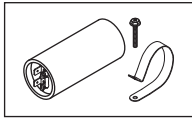

CAPACITOR (145-174µf, 250VAC)

- Motor starting
- Size: 1.81" dia x 3.38" tall
- 50/60Hz; Electrolytic
- Includes: Mounting P-clip and screw
- Also available: Start Box (RPI Part #'s CMA029, CMA033 & CMA039)

Fits: Start Box

RPI Part #CMC031
OEM Part #'s - See Chart Above

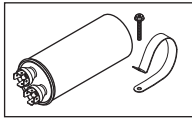

CAPACITOR (20µf, 440VAC)

- Run capacitor
- Size: 1.75" dia x 3.00/3.75" tall
- 50/60Hz.; Electrolytic
- Includes: Mounting P-clip and screw
- Also available: Start Box (RPI Part #CMA029)

Fits: Start Box

RPI Part #CMC034
OEM Part #'s - See Chart Above

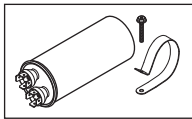

CAPACITOR (10µf, 370VAC)

- Run capacitor
- Size: 1.75" dia x 2.63"/2.17" tall
- 50/60Hz.; Electrolytic
- Includes: Mounting P-clip and screw
- Also available: Start Box (RPI Part #CMA033)

Fits: Start Box

RPI Part #CMC036
OEM Part #'s - See Chart Above

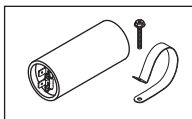

CAPACITOR (430-516µf, 115VAC)

- Motor starting
- Size: 1.81" dia x 3.38" tall
- 50/60Hz.; Electrolytic
- Includes: Mounting P-clip and screw
- Also available: Start Box (RPI Part #CMA035)

Fits: Start Box

RPI Part #CMC037
OEM Part #'s - See Chart Above

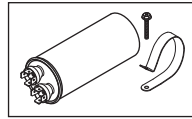

CAPACITOR (40µf, 370VAC)

- Run capacitor
- Size: 2.00" dia x 3.88" tall
- 50/60Hz.; Electrolytic
- Includes: Mounting P-clip and screw
- Also available: Start Box (RPI Part #CMA035)

Fits: Start Box

RPI Part #CMC042
OEM Part #'s - See Chart Above

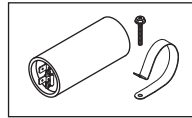

CAPACITOR (540-648µf, 115VAC)

- Motor starting
- Size: 1.81" dia x 3.38/4.38" tall
- 50/60Hz.; Electrolytic
- Includes: Mounting P-clip and screw
- Also available: Start Box (RPI Part #CMA041)

Fits: Start Box

RPI Part #CMC201
OEM Part #'s - See Chart Above

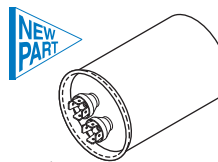

CAPACITOR (65µf, 370VAC)

- Run capacitor
- Size: 2.50" dia. x 3.00" lg.
- 50/60Hz.

Fits: Electrical Control Box

RPI Part #CMC202
OEM Part #'s - See Chart Above

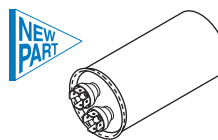

CAPACITOR (55µf, 370VAC)

- Run capacitor
- Size: 2.00" dia. x 3.75/4.31" lg.
- 50/60Hz.

Fits: Electrical Control Box

RPI Part #CMC243
OEM Part #'s - See Chart Above

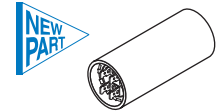

CAPACITOR (460-552µf, 125VAC)

- Start capacitor
- Size: 1.44" dia. x 3.33" lg.
- 50/60Hz.

Fits: Electrical Control Box

RPI Part #CMC203
OEM Part #'s - See Chart Above

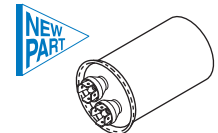

CAPACITOR (27.5µf, 370VAC)

- Run capacitor
- Size: 1.88" dia. x 3.00" lg.
- 50/60Hz.
- See **Notes** below for quantity required

Fits: Electrical Control Box

Notes: Models AirStar 30D and AirStar 30M requires (2) capacitors

RPI Part #PCC636
OEM Part #'s - See Chart Above

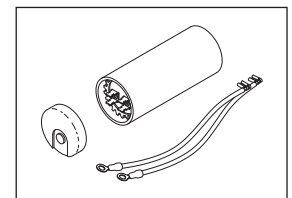

CAPACITOR (590-708µf, 110/125VAC)

- Motor starting
- Size: 1.88" dia. x 3.00" lg.
- 50/60 Hz.
- Includes: Wires set and cap

Fits: Electrical Box

Air Techniques, Apollo/Midmark®, MDT McKesson, DentalEZ®/Custom Air/RamVac, Jun-Air, Matrix/Midmark®, Midmark®, Pelton & Crane, and Tech West/Turbine Ind.

CHECK VALVES

RPI PART #	DESCRIPTION	AIR TECHNIQUES	APOLLO/MIDMARK®	DENTALEZ®/CUSTOM AIR/RAMVAC	MIDMARK®
CMK247	CHECK VALVE UPGRADE KIT	86441			
CMK248	CHECK VALVE UPGRADE KIT	86443			
CMK249	CHECK VALVE UPGRADE KIT	86447			
CMV217	CHECK VALVE	87045		004761SP	
CMV218	CHECK VALVE	85659			
CMV219	CHECK VALVE	86692			
CMV283	CHECK VALVE		PW50515		PW50515



RPI Part #CMK247
OEM Part #'s - See Chart Above

CHECK VALVE UPGRADE KIT

• Includes all parts as shown
Fits: Main Tank Assembly

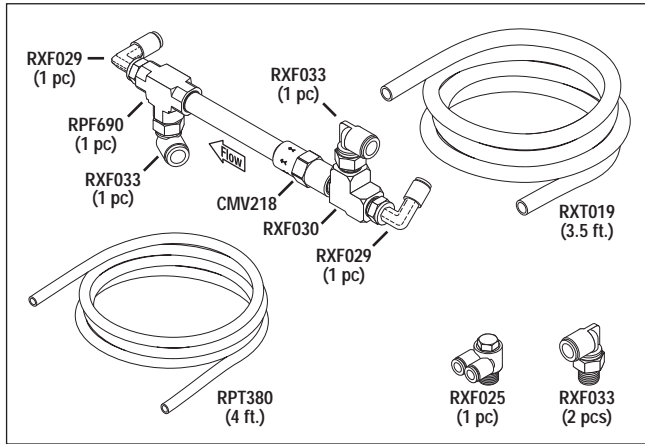

RPI Part #CMK248
OEM Part #'s - See Chart Above

CHECK VALVE UPGRADE KIT

• Includes all parts as shown
Fits: Main Tank Assembly

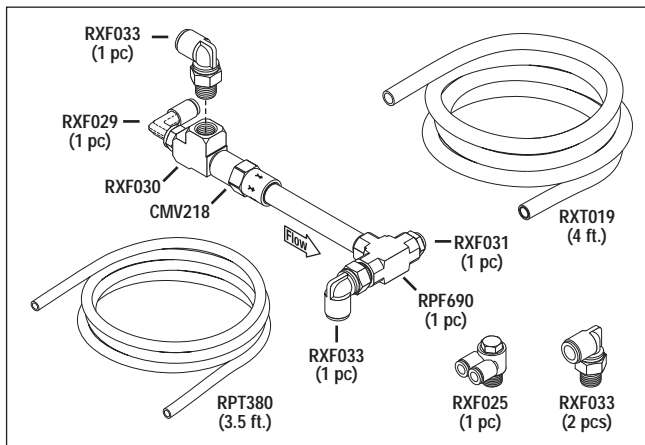

RPI Part #CMK249
OEM Part #'s - See Chart Above

CHECK VALVE UPGRADE KIT

• Includes all parts as shown
Fits: Main Tank Assembly

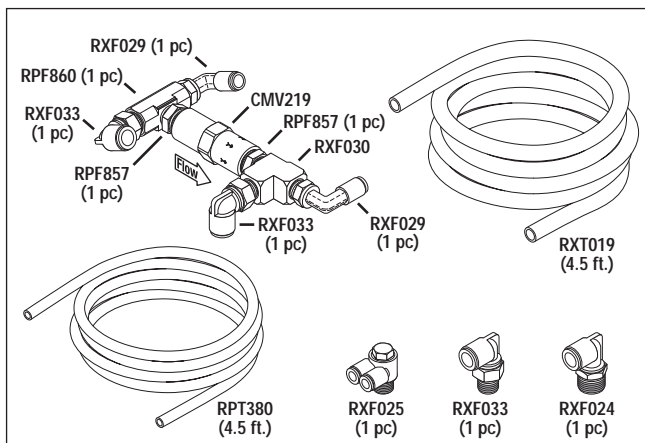

RPI Part #CMV217
OEM Part #'s - See Chart Above

CHECK VALVE

• Ports: 3/8" FPT Inlet x 3/8" MPT Outlet
• Material: Brass body; Buna-N seal
• Size: 7/8" Hex x 1.94" lg.
Fits: Manifold Assembly

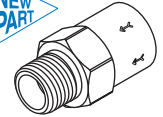

RPI Part #CMV218
OEM Part #'s - See Chart Above

CHECK VALVE

• Cracking pressure: 1-5 PSI
• Ports: 1/4" FPT inlet x 1/4" FPT outlet
• Material: Brass body, Buna-N seal
• Size: 11/16" x 1.80" lg.
• Included In: Check Valve Upgrade Kit (RPI Part #'s CMK247 & CMK248)
Fits: Manifold Assembly

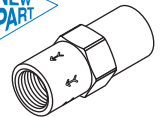

RPI Part #CMV219
OEM Part #'s - See Chart Above

CHECK VALVE

• Cracking pressure: 1.0 PSI
• Ports: 3/8" FPT inlet x 3/8" FPT outlet
• Material: Brass body, Buna-N seal
• Size: 7.8" x 2-1/4" lg.
• Included In: Check Valve Upgrade Kit (RPI Part #CMK249)
Fits: Manifold Assembly

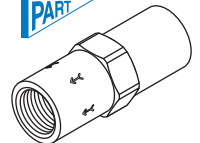

RPI Part #CMV283
OEM Part #'s - See Chart Above

CHECK VALVE

• Cracking Pressure: 1-5 PSI
• Ports: 3/8" MPT Inlet x 3/8" MPT Outlet
• Material: Brass Body; Buna-N Seal
• Size: 11/16" Hex x 1.70" lg.
Fits: Cluster Assembly

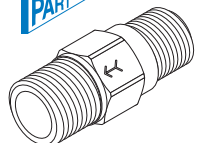

COOLING FANS & ACCESSORIES

RPI PART #	DESCRIPTION	AIR TECHNIQUES	APOLLO MIDMARK®	DENTAL EZ®/ CUSTOM AIR/RAMVAC	JUN-AIR	MDT MCKESSON	MIDMARK®	TECH WEST
CMF019	COOLING FAN (115V)	41060	SEA95535	5451400	JAS445100 Cooling Fan only	3-08-0578-10	65995000	CF-115 Cooling Fan only
CMF020	COOLING FAN (230V)	80516	SEA95540	5451500	JAS445000 Cooling Fan only	3-08-0563-10	EM510305	CF-230 Cooling Fan only
RPC822	SOUND DAMPING COMPOSITE	No OEM Part # Available	No OEM Part # Available	No OEM Part # Available	No OEM Part # Available	No OEM Part # Available	No OEM Part # Available	No OEM Part # Available

RPI Part #CMF019
OEM Part #'s - See Chart Above

COOLING FAN (115VAC)

- Size: 4-11/16" x 4-11/16" x 1-1/2"
- Includes: mounting hardware
- Aluminum housing; Ball bearing

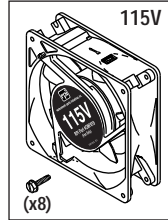

RPI Part #CMF020
OEM Part #'s - See Chart Above

COOLING FAN (230VAC)

- Size: 4-11/16" x 4-11/16" x 1-1/2"
- Includes: mounting hardware
- Aluminum housing; Ball bearing

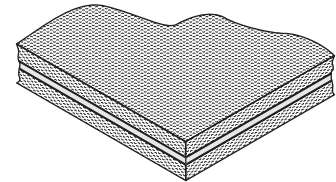
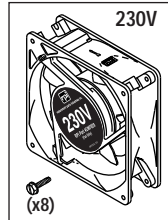

RPI Part #RPC822
OEM Part #'s - See Chart Above

SOUND DAMPING COMPOSITE

- Size: 12" x 12" x 1/2" thk.
- Acoustic foam with vinyl barrier core and adhesive backing; Cut to size

Fits: Dental Compressor Sound Covers including: Midmark® OEM Part #'s 77001603, 77001604, 77001605, & 77001606 and Apollo/Midmark OEM Part #'s ACA70620, ACA70621, ACA70622, ACA70700, ACA70705, ACA70710 & ACA70715

MOISTURE INDICATORS

RPI PART #	DESCRIPTION	AIR TECHNIQUES	APOLLO/MIDMARK®	DENTAL EZ®/ CUSTOM AIR/RAMVAC	MATRX/MIDMARK®	MDT MCKESSON	TECH WEST
CMI077	MOISTURE INDICATOR	60013	ACA86965				
CMI078	MOISTURE INDICATOR			004021			MI-100
CMI079	MOISTURE INDICATOR				77005140		
CMI081	MOISTURE INDICATOR					3-08-1019-20	
RPT579	1/4" TEFLON THREAD SEALING TAPE	No OEM Part # Available	No OEM Part # Available	No OEM Part # Available	No OEM Part # Available	No OEM Part # Available	No OEM Part # Available

RPI Part #CMI077
OEM Part #'s - See Chart Above

MOISTURE INDICATOR

- Zinc plated steel
- Size: 15/16" HEX x 1/2" MPT
- Glass window
- Easy to read color changing legend and indicator: Blue to Pink

Fits: Manifold Block Assembly

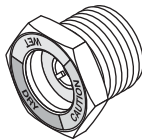

RPI Part #CMI078
OEM Part #'s - See Chart Above

MOISTURE INDICATOR

- Zinc plated steel
- 1/4" MPT
- Glass window
- Easy to read color changing legend and indicator: Blue to Pink

Fits: Manifold Block Assembly

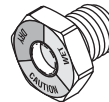

RPI Part #CMI079
OEM Part #'s - See Chart Above

MOISTURE INDICATOR

- Zinc plated steel
- 3/4" MPT
- Glass window
- Easy to read color changing legend and indicator: Blue to Pink

Fits: Manifold Block Assembly

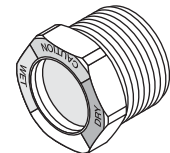

RPI Part #CMI081
OEM Part #'s - See Chart Above

MOISTURE INDICATOR

- Zinc plated steel
- 15/16-20 threads; Includes O-ring seal
- Glass window
- Easy to read color changing legend and indicator: Blue to Pink

Fits: Manifold Block Assembly

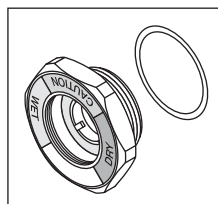

RPI Part #RPT579
OEM Part #'s - See Chart Above

1/4" TEFLON THREAD SEALING TAPE

- 5 per package
- 1/4" x 260" per unit

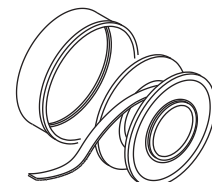

Air Techniques, Apollo/Midmark®, MDT McKesson, DentalEZ®/Custom Air/RamVac, Jun-Air, MatrX/Midmark®, Midmark®, Pelton & Crane, and Tech West/Turbine Ind.

DESICCANTS & DESICCANT TANK FILTERS

RPI PART #	DESCRIPTION	AIR TECHNIQUES	APOLLO/MIDMARK®	MATR/MIDMARK®	MIDMARK®	TECH WEST
CMD091	DESICCANT - See part description below for quantity required	60010	RAM80105			
CMD093	DESICCANT - See part description below for quantity required		RAM80100			MDS-200
CMD094	DESICCANT - See part description below for quantity required	80069				MDS-100
CMF127	CONE FILTER	60097				
CMF129	DESICCANT TANK FILTER		PFM70301	PFM70301	PFM70301	AS-500
CMF130	DESICCANT TANK FILTER		PFM70300	PFM70300	PFM70300	

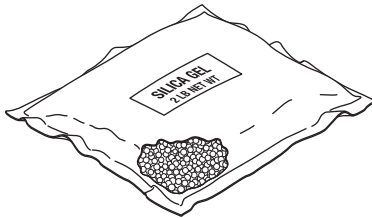

RPI Part #CMD091
OEM Part #'s - See Chart Above

DESICCANT

- Sold in 2 lb. bag
- Air Techniques OEM Part #60010 requires 5 lbs.; Apollo/Midmark OEM Part #RAM80105 requires 14 lbs.
- Material: Grade 20 G Silica Gel
- Also available: Cone Filter (RPI Part #CMF127), Desiccant Tank Filter (RPI Part #CMF129) and Desiccant Tank Filter (RPI Part #CMF130)

Fits: Desiccant Tank



RPI Part #CMD093
OEM Part #'s - See Chart Above

DESICCANT

- Sold in 2 lb. bag
- Apollo/Midmark OEM Part #RAM80105 requires 2 lbs.; Tech West OEM Part #MDS-200 requires 2 lbs.
- Material: Activated Alumina
- Also available: Desiccant Tank Filter (RPI Part #CMF129) and Desiccant Tank Filter (RPI Part #CMF130)

Fits: Desiccant Tank

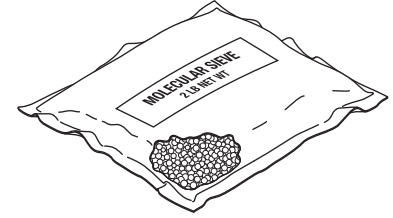

RPI Part #CMD094
OEM Part #'s - See Chart Above

DESICCANT

- Sold in 2 lb. bag
- Air Techniques OEM Part #80069 requires 0.5 lb.; Tech West OEM Part #MDS-100 requires 2 lbs.
- Material: Molecular Sieve
- Also available: Desiccant Tank Filter (RPI Part #CMF129) and Desiccant Tank Filter (RPI Part #CMF130)

Fits: Desiccant Tank

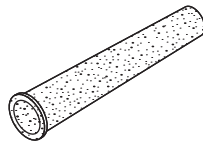

RPI Part #CMF127
OEM Part #'s - See Chart Above

CONE FILTER

- Material: Sintered bronze
- Size: .86" dia. x 4.00" lg.
- Also available: Desiccant (Grade 20 G Silica Gel) (RPI Part #CMD091)

Fits: Drying Chamber

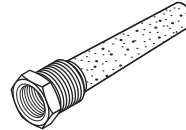

RPI Part #CMF129
OEM Part #'s - See Chart Above

DESICCANT TANK FILTER

- Material: Sintered bronze
- Size: 7/8" hex x 3.62" lg.
- 3/8" FPT x 1/2" MPT brass adaptor
- Also available: Desiccant (Grade 20 G Silica Gel) (RPI Part #CMD091), Desiccant (Activated Alumina) (RPI Part #CMD093) and Desiccant (Molecular Sieve) (RPI Part #CMD094)

Fits: Drying Chamber

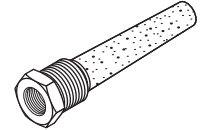

RPI Part #CMF130
OEM Part #'s - See Chart Above

DESICCANT TANK FILTER

- Material: Sintered bronze
- Size: 7/8" hex x 3.62" lg.
- 1/4" FPT x 1/2" MPT brass adaptor
- Also available: Desiccant (Grade 20 G Silica Gel) (RPI Part #CMD091), Desiccant (Activated Alumina) (RPI Part #CMD093) and Desiccant (Molecular Sieve) (RPI Part #CMD094)

Fits: Drying Chamber

DRYERS

RPI Part #CMD234
OEM Part #004018SP

DRYER

- 2 per package
- Size: 12.34" lg. x 2.00" OD
- Includes: (2 pcs) Viton® O-rings (RPI Part #RX0100), and PM Sticker
- It is recommended that this dryer be replaced every 5 years
- **Notes:** There are two dryers per assembly.

Fits: Dryer Assembly

Models: Osprey 13, Osprey 22 & Osprey 23

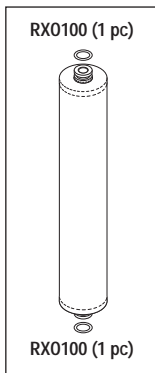

It's the RPI Advantage! Also includes an attached PM Sticker for recording the date that the dryer was replaced.

RPI Part #CMD236
OEM Part #005413SP

DRYER

- 2 per package
- Size: 15.50" lg. x 3.00" OD
- Includes: (2 pcs) Viton® O-rings (RPI Part #RX0100), and PM Sticker
- It is recommended that this dryer be replaced every 5 years
- **Notes:** There are two dryers per assembly.

Fits: Dryer Assembly

Models: Osprey 28

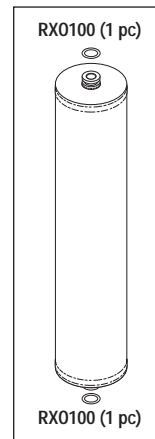

It's the RPI Advantage! Also includes an attached PM Sticker for recording the date that the dryer was replaced.

RPI Part #CMD235
OEM Part #004020SP

DRYER

- 2 per package
- Size: 14.25" lg. x 2.52" OD
- Includes: (2 pcs) Viton® O-rings (RPI Part #RX0100), and PM Sticker
- It is recommended that this dryer be replaced every 5 years
- **Notes:** There are two dryers per assembly.

Fits: Dryer Assembly

Models: Osprey 24 & Osprey 25

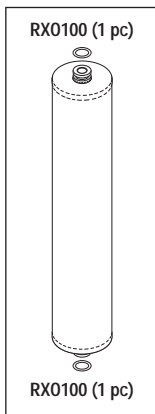

It's the RPI Advantage! Also includes an attached PM Sticker for recording the date that the dryer was replaced.

RPI Part #RX0100
OEM Part # (No OEM Part # Available)

O-RING

- 6 per package
- Size: .549" ID x .755" OD x .103" C/S
- Material: Viton®; 75 Duro
- Included in: Dryer (RPI Part #CMD234), Dryer (RPI Part #CMD235), Dryer (RPI Part #CMD236)

Fits: Dryer Assembly

Models: Osprey 13, Osprey 22 & Osprey 23, Osprey 24, Osprey 25 & Osprey 28

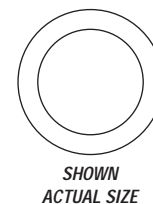

INLET & OUTLET SHUTTLE DISKS

RPI Part #CMD239
OEM Part # (No OEM Part # Available)

OUTLET SHUTTLE DISK

- Material: Teflon®
 - Size: .57" OD dia x .25" thk; 0.037" orifice
- Fits:** Dryer Assembly
Models: Osprey 13, Osprey 22 & Osprey 23

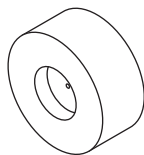

RPI Part #CMD241
OEM Part # (No OEM Part # Available)

OUTLET SHUTTLE DISK

- Material: Teflon®
 - Size: .57" OD x .25" thk; 0.064" orifice
- Fits:** Dryer Assembly
Models: Osprey 28

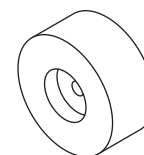

RPI Part #CMD240
OEM Part # (No OEM Part # Available)

OUTLET SHUTTLE DISK

- Material: Teflon®
 - Size: .57" OD x .25" thk; 0.053" orifice
- Fits:** Dryer Assembly
Models: Osprey 24 & Osprey 25

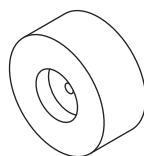

RPI Part #CMD242
OEM Part # (No OEM Part # Available)

INLET SHUTTLE DISK

- Material: Teflon®
 - Size: .57" OD x .25" thk
- Fits:** Dryer Assembly
Models: Osprey 13, Osprey 22 & Osprey 23, Osprey 24, Osprey 25 & Osprey 28

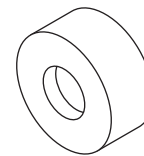

Air Techniques, Apollo/Midmark®, MDT McKesson, DentalEZ®/Custom Air/RamVac, Jun-Air, Matrix/Midmark®, Midmark®, Pelton & Crane, and Tech West/Turbine Ind.

COMPRESSOR HEAD COMPONENT

RPI PART #	DESCRIPTION	APOLLO/MIDMARK®	DENTALEZ® CUSTOM AIR/RAMVAC	JUN-AIR	MIDMARK®	PELTON & CRANE
CMG197	DRAIN PLUG GASKET - 3/PKG		JA6235000	6235000		
CMK287	COMPRESSOR TIP SEAL KIT	HPA30505			HPA30505	
CMP196	OIL PLUG		JA7167000	7167000		
PCG627	GASKET (MUFFLER)					005040
PCG628	GASKET (CYLINDER HEAD)					004924
PCG629	GASKET (VALVE PLATE)					004925
PCG630	GASKET (OIL PAN)					004929
PCG631	GASKET (END COVER)					004930
PCP637	SPRING PAD					004877
PCS638	SPRING					005070
PCV640	VALVE PLATE ASSEMBLY					004976
RP0848	O-RING (RIB COVER GASKET)		JA6244000	6244000		

RPI Part #CMP196
OEM Part #'s - See Chart Above

OIL PLUG

- Material: Nickel plated brass
- 3/8-19 BSPP
- Includes all parts as shown
- Fits: Ribbed Cover

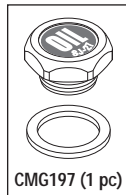

RPI Part #CMG197
OEM Part #'s - See Chart Above

DRAIN PLUG GASKET

- 3 per package
- Material: Fiber
- Size: .668" ID x .889" OD x .066" thk
- Included in: Oil Plug (RPI Part #CMP196) Compressor PM Kits (see page 400)
- Fits: Oil Plug



RPI Part #PCG627
OEM Part #'s - See Chart Above

GASKET (MUFFLER)

- 3 per package
- Fits: Head Assembly

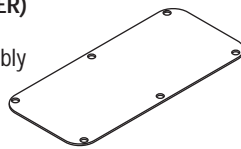

RPI Part #PCG628
OEM Part #'s - See Chart Above

GASKET (CYLINDER HEAD)

- 3 per package
- Fits: Head Assembly

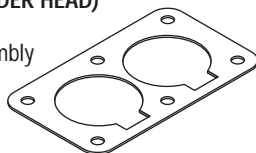

RPI Part #PCG629
OEM Part #'s - See Chart Above

GASKET (VALVE PLATE)

- 3 per package
- Fits: Head Assembly

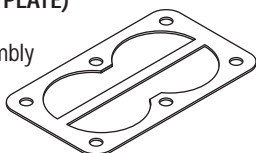

RPI Part #PCG630
OEM Part #'s - See Chart Above

GASKET (OIL PAN)

- Fits: Oil Pan

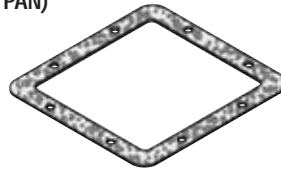

RPI Part #PCG631
OEM Part #'s - See Chart Above

GASKET (END COVER)

- 3 per package
- Fits: End Cover

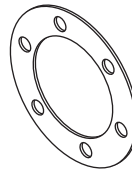

RPI Part #PCP637
OEM Part #'s - See Chart Above

SPRING PAD

- 12 per package
- Material: Buna N;
- Color: Black
- Fits: Mounting Spring



RPI Part #PCS638
OEM Part #'s - See Chart Above

SPRING

- 12 per package
- Fits: Motor Housing



RPI Part #PCV640
OEM Part #'s - See Chart Above

VALVE PLATE ASSEMBLY

- Fits: Head Assembly

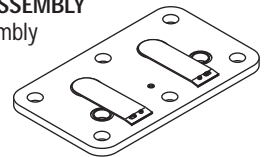

RPI Part #RP0848
OEM Part #'s - See Chart Above

O-RING (RIB COVER GASKET)

- Material: Nitrile (Buna N)
- Size: 176mm ID x 182mm OD x 3mm C/S
- Included in: Compressor PM Kits (see page 400)
- Fits: Ribbed Cover of the Jun-Air M6 Motors

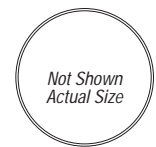

RPI Part #CMK287
OEM Part #'s - See Chart Above

COMPRESSOR TIP SEAL KIT

- For oil-less single headed, belt driven compressors
- OEM recommends replacement every 5,000 hours
- Includes all parts as shown including Grease Cartridge (RPI Part #RXG070, O-Ring Removal Tool (RPI Part #RXT002), and PM Sticker
- Included in: Air Intake Upgrade Kit (RPI Part #CMK280) Belt Tension Tester (RPI Part #RPT954) Compressor PM Kit (RPI Part #CMK274) Compressor PM & Tip Seal Kit (RPI Part #CMK286) Drive Belt (RPI Part #CMB279), and Grease Gun Kit (RPI Part #RXK069)
- Fits: Compressor Head

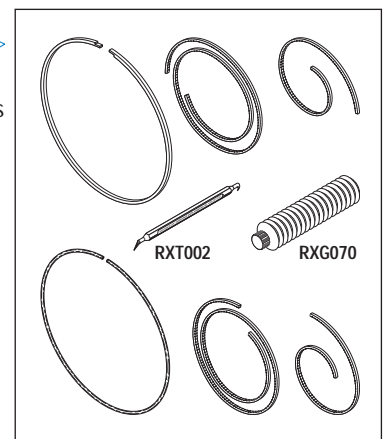

Air Techniques, Apollo/Midmark®, DCI/MDT McKesson, DentalEZ®/Custom Air/RamVac, Jun-Air, Matrix/Midmark®, Midmark®, Pelton & Crane, and Tech West/Turbine Industries
 DENTAL COMPRESSORS - SECTION 4 PAGE 419 UPDATED 01/20

DIFFERENTIAL PRESSURE INDICATORS

RPI PART #	DESCRIPTION	AIR TECHNIQUES	APOLLO/MIDMARK®	DENTAL EZ®/CUSTOM AIR/RAMVAC	JUN-AIR	MATRIX/MIDMARK®	MIDMARK®	TECH WEST
CMC086	BLANK COVER	No OEM Part # Available	No OEM Part # Available	No OEM Part # Available	No OEM Part # Available	No OEM Part # Available	No OEM Part # Available	No OEM Part # Available
CMI015	DIFFERENTIAL PRESSURE INDICATOR (WILKERSON® Part #DP2-01-000)		AAP85210			77002134	65907600	CI-100
CMI095	DIFFERENTIAL PRESSURE INDICATOR (Wilkerson® Brand)	86192						
CMI096	DIFFERENTIAL PRESSURE INDICATOR (Norgren Brand F73)	86192						
CMI231	DIFFERENTIAL PRESSURE INDICATOR			No OEM Part # Available				
CMK216	PRESSURE INDICATOR BYPASS KIT			No OEM Part # Available	No OEM Part # Available			

RPI Part #CMC086
OEM Part #'s - See Chart Above

BLANK COVER

- Wilkerson® brand
 - Black plastic
 - Includes all parts as shown
 - Replaces Differential Pressure Indicator (RPI Part #CMI015)
 - Also available: Coalescing Filter Assembly (RPI Part #'s CMA021 & CMA022)
- Fits:** Wilkerson® brand M16 (5 oz.) & M26 (10 oz.) Series Coalescing Filter Assembly

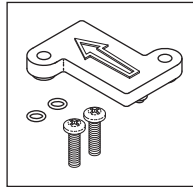

RPI Part #CMI095
OEM Part #'s - See Chart Above

DIFFERENTIAL PRESSURE INDICATOR

- Wilkerson® brand
 - Includes: Mounting screws and O-rings
 - Also available: Particle Filter Assembly (RPI Part #CMA084)
- Fits:** Wilkerson® brand B18, F18 & M18 Series Particle Filter Assembly

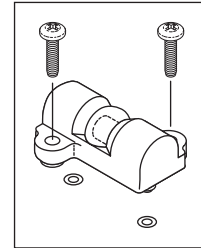

RPI Part #CMI015
OEM Part #'s - See Chart Above

DIFFERENTIAL PRESSURE INDICATOR

- Wilkerson® brand
 - Includes: Screws and O-rings
 - Also available: Coalescing Filter Assembly (RPI Part #'s CMA021 & CMA022)
- Fits:** Wilkerson® brand M16 (5 oz.) & M26 (10 oz.) Series Coalescing Filter Assembly

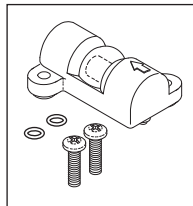

RPI Part #CMI231
OEM Part #'s - See Chart Above

DIFFERENTIAL PRESSURE INDICATOR

- SMC® brand
 - Includes: Gasket and mounting screws
 - Also available: Coalescing Filter Assembly (RPI Part #'s CMA229) and Particulate Filter Assembly (RPI Part #CMA230)
- Fits:** Coalescing Filter Assembly and Particulate Filter Assembly

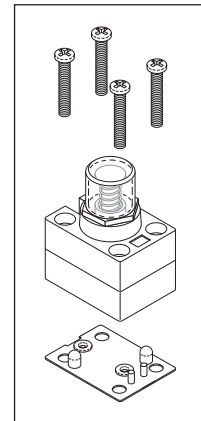

RPI Part #CMI096
OEM Part #'s - See Chart Above

DIFFERENTIAL PRESSURE INDICATOR

- Norgren® brand
 - Includes: Mounting screws
 - Also available: Particle Filter Assembly (RPI Part #CMA082)
- Fits:** Norgren® brand F73 Series Particle Filter Assembly

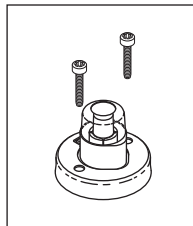

RPI Part #CMK216
OEM Part #'s - See Chart Above

BLANKING KIT

- Material: Stainless steel screws and Nylon® washers
 - Includes all parts as shown
 - Replaces **discontinued** Differential Pressure Indicator (RPI Part #CMI106)
- Fits:** Coalescing Filter Assembly on the Dryer "DH" Series

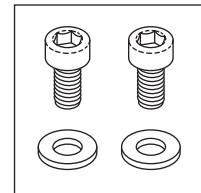

Air Techniques, Apollo/Midmark®, MDT McKesson, DentalEZ®/Custom Air/RamVac, Jun-Air, Matrix/Midmark®, Midmark®, Pelton & Crane, and Tech West/Turbine Ind.

FILTERS - AIR INTAKE FILTERS & ELEMENTS

RPI PART #	DESCRIPTION	AIR TECHNIQUES	APOLLO/MIDMARK®	DENTALEZ®/CUSTOM AIR/JUN-AIR/RAMVAC	MATRIX/MIDMARK®	MIDMARK®
CME004	REPLACEMENT FILTER ELEMENT		Fits RPI Part #CMK003 only			Fits RPI Part #CMK003 only
CME071	AIR FILTER ELEMENT				77001541	77001541
CMF073	AIR INTAKE FILTER			JA5413210		
CMK003	FRESH AIR INTAKE FILTER KIT		PFM50955		ACP90505	ACP90505
CMK065	AIR FILTER ELEMENT KIT	89938 & 89831				

RPI Part #CMK003

OEM Part #'s - See Chart Above

FRESH AIR INTAKE FILTER KIT

- Can also be used for air intake systems
- Includes: Filter Housing, (2 pc) Uniclamp (RPI Part #RPC442), Tubing (.50" ID x .73" OD Clear/Braided - sold by the foot) (RPI Part #RPT441), (1 pc) Cap (RPI Part #RPC443), (1 pc) Adaptor (1/4" MPT x 1/4" MPT) (RPI Part #RPF833), Replacement Filter Element (RPI Part #CME004), and PM sticker

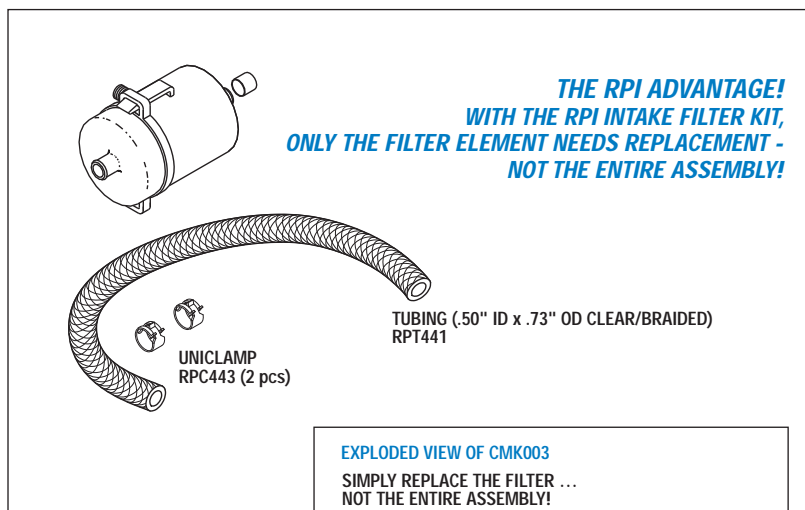

It's the RPI Advantage! Also includes a PM Sticker that can be attached to the filter housing for recording the date that the filter element was replaced.

RPI Part #CME004

OEM Part #'s - Fits RPI Part #CMK003 only

REPLACEMENT FILTER ELEMENT

- Can also be used for air intake systems
- Replacement filter element for Fresh Air Intake Filter Kit (RPI Part #CMK003) **only**
- Includes: O-ring, and PM sticker
- Size: 1.56" OD x 2.96" lg.

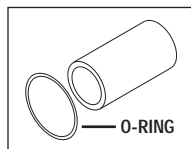

RPI Part #CMK065

OEM Part #'s - See Chart Above

AIR FILTER ELEMENT KIT

- 10 micron paper filter
- Size: 1.25" OD x 3.77" lg.
- Includes: Elbow barb fitting, and PM sticker
- Can be used with a Fresh Air Intake System
- See **Note 1** below for quantity required for each model

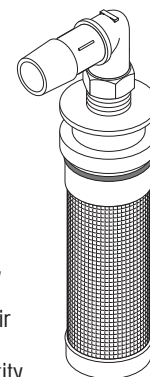

RPI Part #CME071

OEM Part #'s - See Chart Above

AIR FILTER ELEMENT

- Size: 1.38" OD x 3.43" lg.
- Used for Fresh Air intake
- Includes: Rubber Air Filter Cap, and PM sticker
- Can be used for Fresh Air intake
- See **Note 2** below for quantity required for each model

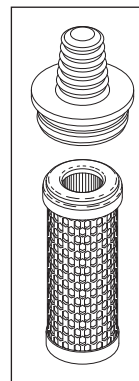

Fits: Compressor heads

RPI Part #CMF073

OEM Part #'s - See Chart Above

AIR INTAKE FILTER

- 5 micron polyester filter
- Size: 1.58" OD x 2.39" lg. plastic housing
- Can be used for Fresh Air intake
- Includes: 10.50" of .38" OD clear tubing, and PM sticker
- See **Note 3** below for quantity required for each model

Fits: Compressor Head Assembly

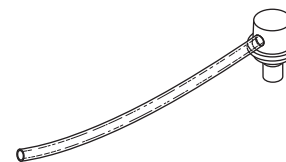

Note 1: Air Techniques: AirStar® 1 & 10 requires (1); AirStar® 2-1, 2-2, 3, 21, 22 & 30 requires (2); AirStar® 5 & 50 requires (4); AirStar® 7 & 70 requires (6), and AirStar® 100M requires (8).

Note 2: Matrix: OL-3, OL-2000 & OL-2001 requires (2); OL-7 & OL-4000 requires (4); and OL-10 & OL-6000 requires (6). Midmark: P52 requires (4) and P72 requires (6).

Note 3: DentalEZ/Custom Air/Jun-Air/RamVac: CA-711 & CA721 require (1); CA-713 & CA-723 requires (2); CA-813-D & CA-823-D (Serial #440537 and below) requires (2); and CA-725 requires (4).

FILTERS - AIR INTAKE FILTERS & ELEMENTS (continued)

RPI PART #	DESCRIPTION	AIR TECHNIQUES	APOLLO/MIDMARK®	DENTAL EZ®/CUSTOM AIR/RAMVAC	JUN-AIR	MATR X/MIDMARK®	MDT MCKESSON	TECH WEST
CMA068	AIR FILTER ASSEMBLY							TAF-100
CMA070	AIR FILTER ASSEMBLY							TAF-200
CMA072	AIR FILTER ASSEMBLY			004006				
CME067	AIR FILTER ELEMENT			003965				TIF-100
CME069	AIR FILTER ELEMENT							TIF-200
CME074	INTAKE FILTER ELEMENT			JA5412500	JA5412500			
CME080	AIR FILTER ELEMENT			003965				
CMF002	AIR INTAKE FILTER	80050	PFM50955					
CMF011	FOAM ELEMENT	60043-1						
CMF013	FOAM ELEMENT					7700709		AAF-100
CMF014	FOAM ELEMENT						3-08-0632-10	
CMF075	INTAKE FILTER			JA5412400	JA5412400			

RPI Part #CMA068
OEM Part #'s - See Chart Above

AIR FILTER ASSEMBLY

- Size: 2.45" OD x 3.17" H
 - Ports: 3/8" NPSC Female inlet x 1/4" MPT outlet
 - Includes: Air Filter Element (RPI Part #CME067)
 - Can be used with a Fresh Air Intake System
 - See **Note 1** below for required quantity for each model
- Fits:** 1 HP Compressor Head

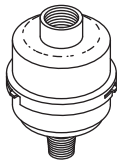

RPI Part #CMA072
OEM Part #'s - See Chart Above

AIR FILTER ASSEMBLY

- Size: 2.45" OD x 3.17" H
 - Ports: 3/8" NPSC Female inlet x 3/8" MPT outlet
 - Includes: Air Filter Element (RPI Part #CME080)
 - Can be used with a Fresh Air Intake System
- Fits:** 1 HP Compressor Head

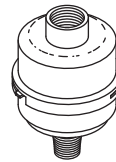

RPI Part #CMF011
OEM Part #'s - See Chart Above

FOAM ELEMENT

- Size: 4.25" OD x 2.00" lg.

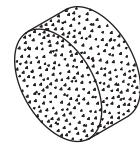

RPI Part #CME067
OEM Part #'s - See Chart Above

AIR FILTER ELEMENT

- 2 micron paper filter
 - Size: 2.25" OD x 1.00" H
 - See **Note 1** below for required quantity for each model
- Fits:** Air Filter Assembly



RPI Part #CME080
OEM Part #'s - See Chart Above

AIR FILTER ELEMENT

- 25 micron polyester filter
 - Size: 2.25" OD x 1.00" H
- Fits:** Air Filter Assembly

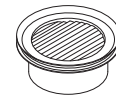

RPI Part #CMF013
OEM Part #'s - See Chart Above

FOAM ELEMENT

- Size: 2.00" OD x 2.00" lg.

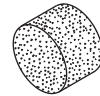

RPI Part #CMA070
OEM Part #'s - See Chart Above

AIR FILTER ASSEMBLY

- Size: 3.20" OD x 3.96" H
 - Ports: 3/8" NPSC Female inlet x 1/4" MPT outlet
 - Includes: Air Filter Element (RPI Part #CME069)
 - Can be used with a Fresh Air Intake System
- Fits:** 2 HP Compressor Head

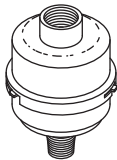

RPI Part #CME074
OEM Part #'s - See Chart Above

INTAKE FILTER ELEMENT

- Size: 1.36" OD x 3.28" lg.
- 5 micron paper filter
- See **Note 2** below for required quantity for each model

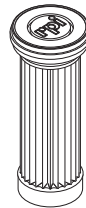

RPI Part #CMF014
OEM Part #'s - See Chart Above

FOAM ELEMENT

- Size: 2.50" OD x 4.50" lg.

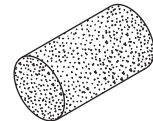

RPI Part #CME069
OEM Part #'s - See Chart Above

AIR FILTER ELEMENT

- 2 micron paper filter
 - Size: 3.00" OD x 1.38" H
- Fits:** Air Filter Assembly



RPI Part #CMF002
OEM Part #'s - See Chart Above

AIR INTAKE FILTER (METAL STYLE)

- Size: 1.84" OD x 3.63" lg.
- Port: 1/4" MPT
- Auto Muffler MO2

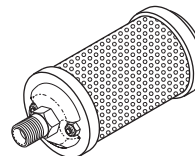

RPI Part #CMF075
OEM Part #'s - See Chart Above

INTAKE FILTER

- Size: 1.04" OD x 2.38" lg.
- 5 micron polyester filter
- 1 per package - each unit requires (2)
- Can be used with a Fresh Air Intake System



Note 1: DentalEZ/Custom Air/RamVac: 1013D requires (2), 1022 requires (1), 1023D requires (2), 1025D requires (2), 1027D requires (2) & 1029T requires (3). Tech West: ACL2S1/ND, ACL2S2/ND & ACL4D2/ND (2005 and earlier) requires (1); ACL2S1, ACL2S2 & ACL4D2 (2006 and later) requires (1); AC02S1/ND & AC02S2/ND requires (2); AC04S2/ND (2005 and earlier) and AC04D2/ND requires (4); AC06T2/ND requires (6).

Note 2: Jun-Air: CA-812, CA-822, CA-912 & CA-922 requires (1); CA-825/D/Q, CA-925/D requires (2); CA-827-D & CA-927-D requires (3); CA-829-D & CA-929-D requires (4); and CA-8212-T requires (6).

Air Techniques, Apollo/Midmark®, MDT McKesson, DentalEZ®/Custom Air/RamVac, Jun-Air, Matrix/Midmark®, Midmark®, Pelton & Crane, and Tech West/Turbine Ind.

FILTERS - AIR INTAKE FILTERS & ELEMENTS (continued)

RPI PART #	DESCRIPTION	APOLLO/ MIDMARK®	MIDMARK®	PELTON & CRANE
CMA289	AIR FILTER ASSEMBLY	No OEM Part # Available	No OEM Part # Available	
CME281	AIR INTAKE FILTER ELEMENT	PFM50950 (rectangular style)	PFM50950 (rectangular style)	
CME288	AIR FILTER ELEMENT	No OEM Part # Available		No OEM Part # Available
CMF282	AIR INTAKE FILTER	No OEM Part # Available		No OEM Part # Available
CMK280	AIR INTAKE UPGRADE KIT	PFM50950 (rectangular style)	PFM50950 (rectangular style)	
PCC626	FILTER CAP (AIR INLET)			005097
PCF625	FILTER (FELT)			005031
PCS624	FILTER SCREEN			005044

NEW PART
Fits Scroll Style Compressors

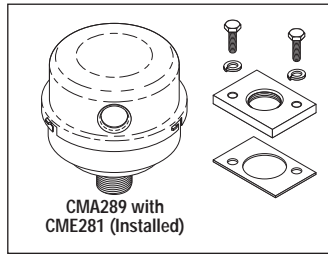

RPI Part #CMK280
OEM Part #'s - See Chart Above

AIR INTAKE UPGRADE KIT

- **Important!** See *Notes* below
- Includes: Air Filter Assembly (RPI Part #CMA289), Air Intake Filter Element (RPI Part #CME281), PM Sticker, mounting bracket, gasket, and mounting hardware

Fits: Compressor Head

Note: This Kit replaces the old "rectangular" style filter.

RPI Part #CMA289
OEM Part #'s - See Chart Above

AIR FILTER ASSEMBLY

- **Important!** See *Notes* below
- Port: 3/4" MPT
- 2 Microns
- Includes: Air Intake Filter Element (RPI Part #CME281) and PM Sticker
- Included in: Air Intake Upgrade Kit (RPI Part #CMK280)

Fits: Air Intake Manifold

NEW PART
Fits Scroll Style Compressors

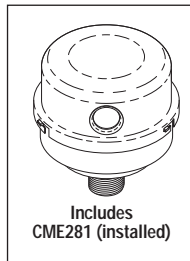

RPI Part #CME281
OEM Part #'s - See Chart Above

AIR INTAKE FILTER ELEMENT

- **Important!** See *Notes* below
- Size: 4.12" OD x 4.50" lg.
- 2 Microns
- Included in: Air Filter Assembly (RPI Part #CMA289), Air Intake Upgrade Kit (RPI Part #CMK280), Compressor PM Kit (RPI Part #CMK274), and Compressor PM & Tip Seal Kit (RPI Part #CMK286)

Fits: Upgraded Air Intake Filter Assembly

NEW PART
Fits Scroll Style Compressors



Notes: This Air Filter Assembly and Air Filter Element is only a replacement for the newer round-shaped style Air Intake Filter Assembly.

This Filter and Assembly is not to be used with the older discontinued rectangular-style Air Intake Filter Assembly. To convert from the older style assembly to the newer round-shaped style assembly, see RPI's Air Intake Upgrade Kit (RPI Part #CMK280).

NEW PART



CME288

RPI Part #CMF282
OEM Part #'s - See Chart Above

AIR INTAKE FILTER

- **Important!** See *Notes* below
- Size: 2" dia. x 3.4" lg. x 1/4" MPT
- 50 Microns
- Includes: Air Filter Element (RPI Part #CME288)

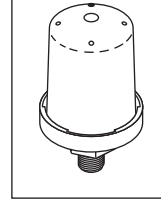

RPI Part #CME288
OEM Part #'s - See Chart Above

AIR FILTER ELEMENT

- **Important!** See *Notes* below
- Size: 1.30" OD x .62" ID x 1.00" lg.
- 50 Microns

Fits: Air Intake Filter Housing

NEW PART



Notes: Apollo/Midmark: This Air Intake Filter only fits the air filter housing with a single threaded port on the older style AOCRS11 and AOCRS12 models.

This is not to be used on the newer style AOCRS11 and AOCRS12 models where the housing has two ports, one at each end of the housing.

RPI Part #PCS624
OEM Part #'s - See Chart Above

FILTER SCREEN

- 3 per package
- Copper 20 mesh

Fits: Motor Housing

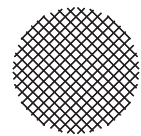

RPI Part #PCF625
OEM Part #'s - See Chart Above

FILTER (FELT)

- 12 per package

Fits: Air Inlet

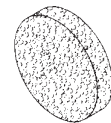

RPI Part #PCC626
OEM Part #'s - See Chart Above

FILTER CAP (AIR INLET)

- Aluminum

Fits: Head Assembly

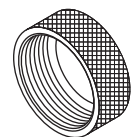

FILTERS - COALESCING AND PARTICULATE FILTER ELEMENTS

RPI PART #	DESCRIPTION	APOLLO/ MIDMARK®	DENTALEZ®/ CUSTOM AIR/RAMVAC	JUN-AIR	MATRIX/ MIDMARK®	MIDMARK®	TECH WEST
CMK005	COALESCING FILTER ELEMENT (WILKERSON® Part #MSP-95-988) • Type B, 0.5 micron	ACA86050 Type B, Wilkerson Filter only	648-00209 Type B, Wilkerson Filter only	648-00209 Type B, Wilkerson Filter only	77005005 Type B, Wilkerson Filter only	77005009 Type B, Wilkerson Filter only	
CMK006	COALESCING FILTER ELEMENT (WILKERSON® Part #MSP-95-989) • Type B, 0.5 micron	ACA86055 Type B, Wilkerson Filter only	645-45010 Type B, Wilkerson Filter only	JA4081500 Type B, Wilkerson Filter only		77005002	CFE-375 Type B, Wilkerson Filter only
CMK024	COALESCING FILTER ELEMENT (WILKERSON® Part #MTP-95-548) • Type C, 0.01 micron	ACA86050 Type C, Wilkerson Filter only	648-00209 Type C, Wilkerson Filter only	648-00209 Type C, Wilkerson Filter only	77005005 Type C, Wilkerson Filter only	77005009 Type C, Wilkerson® Filter only	
CMK025	COALESCING FILTER ELEMENT (WILKERSON® Part #MTP-95-549) • Type C, 0.01 micron	ACA86055 Type C, Wilkerson Filter only	645-45010 Type C, Wilkerson Filter only	JA4081500 Type C, Wilkerson Filter only			CFE-375 Type C, Wilkerson Filter only
CMK026	COALESCING FILTER ELEMENT (GENERIC BRAND) • Type C, 0.01 micron	ACA86050 Type C, Generic Filter only	648-00209 Type C, Generic Filter only	648-00209 Type C, Generic Filter only	77005005 Type C, Generic Filter only	77005009 Type C, Generic Filter only	
CMK027	COALESCING FILTER ELEMENT (GENERIC BRAND) • Type C, 0.01 micron	ACA86055 Type C, Generic Filter only	645-45010 Type C, Generic Filter only	JA4081500 Type C, Generic Filter only			CFE-375 Type C, Generic Filter only



RPI Part #CMK005
OEM Part #'s - See Chart Above

COALESCING FILTER ELEMENT

- Wilkerson® (MSP-95-988)
- Size: 1.59" OD x 2.05" lg.
- **Type B**; 0.5 micron
- Includes all parts as shown and PM sticker
- Fits:** Wilkerson® brand M16 (5 oz.) Series Coalescing Filter Assembly

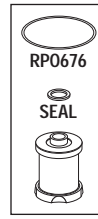

RPI Part #CMK024
OEM Part #'s - See Chart Above

COALESCING FILTER ELEMENT

- Wilkerson® (MTP-95-548)
- Size: 1.59" OD x 2.05" lg.
- **Type C**; 0.01 micron
- Includes all parts as shown and PM sticker
- Fits:** Wilkerson® brand M16 (5 oz.) Series Coalescing Filter Assembly

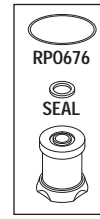

RPI Part #CMK026
OEM Part #'s - See Chart Above

COALESCING FILTER ELEMENT

- Generic brand
- Size: 1.75" OD x 2.03" lg.
- **Type C**; 0.01 micron
- Includes all parts as shown and PM sticker
- Fits:** Wilkerson® brand M16 (5 oz.) Series Coalescing Filter Assembly



RPI Part #CMK006
OEM Part #'s - See Chart Above

COALESCING FILTER ELEMENT

- Wilkerson® (MSP-95-989)
- Size: 1.89" OD x 2.82" lg.
- **Type B**; 0.5 micron
- Includes: Filter Element, Seal, Bowl O-ring (RPI Part #RPO677), PM sticker, and (1) additional Bowl O-ring (RPI Part #RPO675)
- Fits:** Wilkerson® brand M26 (10 oz.) Series Coalescing Filter Assembly

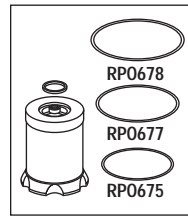

RPI Part #CMK025
OEM Part #'s - See Chart Above

COALESCING FILTER ELEMENT

- Wilkerson® (MTP-95-549)
- Size: 1.89" OD x 2.80" lg.
- **Type C**; 0.01 micron
- Includes all parts as shown and PM sticker
- Fits:** Wilkerson® brand M26 (10 oz.) Series Coalescing Filter Assembly

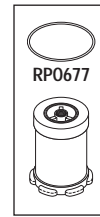

RPI Part #CMK027
OEM Part #'s - See Chart above

COALESCING FILTER ELEMENT

- Generic brand
- Size: 1.75" OD x 2.75" lg.
- **Type C**; 0.01 micron
- Includes all parts as shown and PM sticker
- Fits:** Wilkerson® brand M26 (10 oz.) Series Coalescing Filter Assembly

Air Techniques, Apollo/Midmark®, MDT McKesson, DentalEZ®/Custom Air/RamVac, Jun-Air, MatrX/Midmark®, Midmark®, Pelton & Crane, and Tech West/Turbine Ind.

FILTERS - COALESCING AND PARTICULATE FILTER ELEMENTS *(continued)*

RPI PART #	DESCRIPTION	AIR TECHNIQUES	DENTALEZ®/ CUSTOM AIR/RAMVAC	JUN-AIR	TECH WEST
CME043	COALESCING FILTER ELEMENT (Wilkerson® Brand)		004005		
CME044	COALESCING FILTER ELEMENT (Wilkerson® Brand)		003846		
CME083	PARTICLE FILTER ELEMENT (Norgren® Brand)	85602			
CME085	PARTICLE FILTER ELEMENT (Wilkerson® Brand)	86193			
CME102	CARBON FILTER ELEMENT	87367			
CME103	FILTER ELEMENT	87366			
CME104	CARBON FILTER ELEMENT		JA4080500	64800-213	
CME105	COALESCING FILTER ELEMENT		JA4081600	64800-214	
CME107	FILTER ELEMENT		JA4081602	4081602	
CME110	COALESCING FILTER ELEMENT				CFEO-375
CME227	COALESCING FILTER ELEMENT		005150		
CME228	PARTICULATE FILTER ELEMENT		005151		

RPI Part #CME043

OEM Part #'s - See Chart Above

COALESCING FILTER ELEMENT

- Wilkerson® brand
- Size: 1.38" OD x 2.20" lg.
- Type B: .5 micron
- Includes all parts as shown and PM Sticker

Fits: Coalescing Filter Assembly



RP0685

RPI Part #CME102

OEM Part #'s - See Chart Above

FILTER ELEMENT

- Size: 1.53" OD x 2.70" lg.
- 35 micron filter
- Includes all parts as shown and PM Sticker

Fits: Bottom of the Membrane Dryer Assembly (Air Techniques Part #87175)

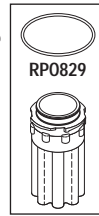

RP0829

RPI Part #CME107

OEM Part #'s - See Chart Above

FILTER ELEMENT

- Size: 1.42" OD x 2.75" lg.
- 0.01 micron
- Includes all parts as shown and PM Sticker

Fits: "D" Series Absorption Dryers



RP0837

RPI Part #CME044

OEM Part #'s - See Chart Above

COALESCING FILTER ELEMENT

- Wilkerson® brand
- Size: 1.38" OD x 2.20" lg.
- Type C: 0.01 micron
- Includes all parts as shown and PM Sticker

Fits: Coalescing Filter Assembly



RP0685

RPI Part #CME103

OEM Part #'s - See Chart Above

FILTER ELEMENT

- Size: 1.12" OD x 2.74" lg.
- 2 micron paper filter
- Includes all parts as shown and PM Sticker

Fits: Top of the Membrane Dryer Assembly (Air Techniques Part #87175)

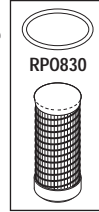

RP0830

RPI Part #CME110

OEM Part #'s - See Chart Above

COALESCING FILTER ELEMENT

- Size: 1.39" OD x 2.50" lg.
- 0.01 micron filter material
- Includes all parts as shown and PM Sticker

Fits: Coalescing Filter Assembly (Tech West Part #CFAO-375 & Parker/Balston Part #2003N-1B1-BX) only

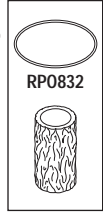

RP0832

RPI Part #CME083

OEM Part #'s - See Chart Above

PARTICLE FILTER ELEMENT

- Norgren® brand
- Size: .93" OD x 1.44" lg.
- 5 micron filter element
- Includes all parts as shown and PM Sticker
- Also available: Particle Filter Assembly (RPI Part #CMA082)

Fits: Norgren® brand F73 Series Particle Filter Assembly



RP0718

RPI Part #CME104

OEM Part #'s - See Chart Above

CARBON FILTER ELEMENT

- Size: 1.55" O.D. x 2.63" lg.
- Type "D" 0.003 PPM activated carbon
- Includes all parts as shown and PM Sticker

Fits: Coalescing Combination Filter Assembly



RP0831

O-RING

RPI Part #CME227

OEM Part #'s - See Chart above

COALESCING FILTER ELEMENT

- 0.30 Micron filter material
- Includes all parts as shown and PM Sticker

Fits: Coalescing Filter Assembly

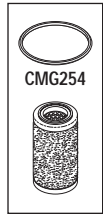

CMG254

RPI Part #CME085

OEM Part #'s - See Chart Above

PARTICLE FILTER ELEMENT

- Wilkerson® brand
- Size: 1.30" OD x 1.62" lg.
- 5 micron filter element
- Includes all parts as shown and PM Sticker
- Also available: Particle Filter Assembly (RPI Part #CMA084)

Fits: Wilkerson® brand B18, F18 & M18 Series Particle Filter Assembly



RP0685

RPI Part #CME105

OEM Part #'s - See Chart Above

COALESCING FILTER ELEMENT

- Size: 1.38" OD x 2.62" lg.
- 0.01 micron filter element
- Includes all parts as shown and PM Sticker

Fits: Coalescing Combination Filter Assembly

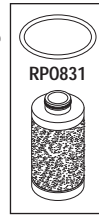

RP0831

RPI Part #CME228

OEM Part #'s - See Chart Above

PARTICULATE FILTER ELEMENT

- 0.01 Micron filter material
- Includes all parts as shown and PM Sticker

Fits: Particulate Filter Assembly

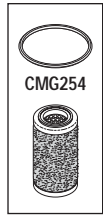

CMG254

FILTERS - FOAM INSERTS/PURGE FILTERS/PURGE MUFFLERS

RPI PART #	DESCRIPTION	AIR TECHNIQUES	APOLLO/MIDMARK®	DENTAL EZ®/CUSTOM AIR/RAMVAC	MATRIX/MIDMARK®	MIDMARK®	TECH WEST
CMF012	FOAM INSERT/PURGE FILTER						FA-100
CMM017	PURGE MUFFLER	80330					AS-250
CMM023	PURGE MUFFLER						PM-500
CMM237	PURGE MUFFLER			004088			
CMM238	PURGE MUFFLER			005082			
CMM261	PURGE MUFFLER			004856			
CMS128	PURGE MUFFLER		62983300		62983300	62983300	
RPF834	FILTER/MUFFLER		No OEM Part # Available		No OEM Part # Available	No OEM Part # Available	No OEM Part # Available

RPI Part #CMF012
OEM Part #'s - See Chart Above

FOAM INSERT/PURGE FILTER

- Size: 5.00" OD x 5.50" lg.
- Material: Reticulated foam
- Includes PM Sticker

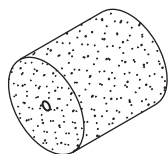

It's the RPI Advantage! Also includes a PM Sticker that can be attached to the filter housing for recording the date that the filter was replaced.

RPI Part #CMM017
OEM Part #'s - See Chart Above

PURGE MUFFLER

- Size: 1-1/4" lg.; 1/4" MPT with 9/16" hex
- Material: Sintered bronze

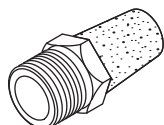

RPI Part #CMM023
OEM Part #'s - See Chart Above

PURGE MUFFLER

- Size: 2-3/4" lg.; 1/2" MPT with 7/8" hex
- Material: Zinc plated steel body

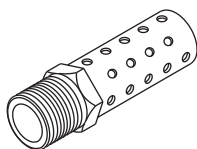

RPI Part #CMM237
OEM Part #'s - See Chart Above

PURGE MUFFLER

- Port Size: 1/4" MPT
 - Size: 13/16" OD x 2-7/16" lg. with 11/16" hex
 - Material: Polyvinyl foam
- Fits:** Dryer Assembly

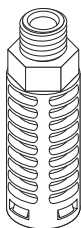

RPI Part #CMM238
OEM Part #'s - See Chart Above

PURGE MUFFLER

- Port Size: 3/8" MPT
 - Size: 1" OD x 2 5/8" lg. with 1" hex
 - Material: Polyvinyl foam
- Fits:** Dryer Assembly

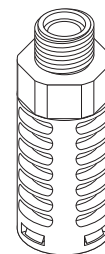

RPI Part #CMM261
OEM Part #'s - See Chart Above

PURGE MUFFLER

- Port Size: 1/8" MPT
 - Size: .51" OD x 1.50" lg. with 1" hex
 - Material: Sintered copper alloy
- Fits:** Dryer Assembly

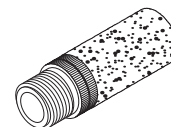

RPI Part #RPF834
OEM Part #'s - See Chart Above

FILTER/MUFFLER

- Size: 1" OD X 2-3/4" O/A lg.; 3/8" MPT
 - Material: Plastic threads with Hope element
 - Included in: Collection Container Kit (RPI Part #CMK180)
- Fits:** Collection Container Kit (RPI Part #CMK180)

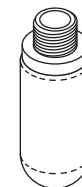

RPI Part #CMS128
OEM Part #'s - See Chart Above

EXHAUST SILENCER

- Port Size: 1/2" FPT
 - 1/4" (6mm) drain tubing connector
 - Silences exhaust and eliminates mist
 - Service Tip: It is recommended to replace twice a year
 - Also available: Adaptor (1/4" MPT x 1/4" MPT) (RPI Part #RPF833), Adaptor (1/4" FPT x 1/2" MPT) (RPI Part #RPF818), Drain Tubing (RPI Part #RPT604), Collection Container Kit (RPI Part #CMK181), and PM Sticker
- Fits:** Purge Solenoid Valve

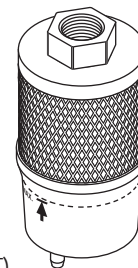

It's the RPI Advantage! Also includes a PM Sticker that can be attached to the exhaust silencer for recording the date that the exhaust silencer was replaced.

Air Techniques, Apollo/Midmark®, MDT McKesson, DentalEZ®/Custom Air/RamVac, Jun-Air, MatrX/Midmark®, Midmark®, Pelton & Crane, and Tech West/Turbine Ind.

FITTINGS



RPI Part #RPF651
OEM Part # (No OEM Part # Available)

ADAPTOR FITTING (3/8" TUBE x 1/8" MPT)

- Material: Acetal
 - Included in: Auto Float Drain (RPI Part #CMF016), Coalescing Filter Assembly - 5 oz. (RPI Part #CMA021), and Coalescing Filter Assembly - 10 oz. (RPI Part #CMA022)
- Fits:** 3/8" tube to 1/8" MPT

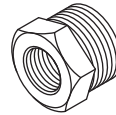

RPI Part #RPF818
OEM Part #62903606

ADAPTOR (1/4" FPT x 1/2" MPT)

- 2 per package
 - Material: Brass
 - Also available: Exhaust Silencer (RPI Part #CMS128)
- Fits:** Connects Exhaust Silencer to Solenoid Valve

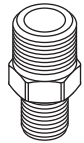

RPI Part #RPF828
OEM Part # (No OEM Part # Available)

ADAPTOR (1/4" MPT x 3/8" MPT)

- 2 per package
 - Material: Brass
 - Included in: Unloader Valve (RPI Part #CMV121)
- Fits:** Unloader Valve

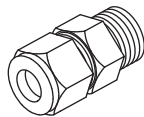

RPI Part #RPF662
OEM Part # (No OEM Part # Available)

MALE CONNECTOR (3/8" TUBE x 1/4" MPT)

- Material: Brass
 - Includes: Compression Nut (RPI Part #RPF222) and Compression Sleeve (RPI Part #RPF218)
 - Included in: Collection Container Kit (RPI Part #CMK180) and Unloader Valve (RPI Part #CMV123)
- Fits:** Collection Container Kit and Unloader Valve

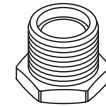

RPI Part #RPF826
OEM Part # (No OEM Part # Available)

ADAPTOR (3/8" FPT x 1/2" MPT)

- 2 per package
 - Material: Brass
 - Included in: Unloader Valve (RPI Part #CMV121)
- Fits:** Unloader Valve

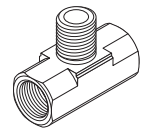

RPI Part #RPF860
OEM Part # (No OEM Part # Available)

MALE BRANCH TEE (1/4" FPT x 1/4" MPT)

- Material: Brass
 - Included in: Check Valve Upgrade Kit (RPI Part #CMK249)
- Fits:** 1/4" FPT and MPT Ports

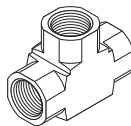

RPI Part #RPF690
OEM Part # (No OEM Part # Available)

TEE FITTING (1/4" FPT)

- Material: Brass
 - Included in: Check Valve Upgrade Kit (RPI Part #'s CMK247 & CMK248)
- Fits:** 1/4" FPT ports

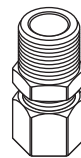

RPI Part #RPF827
OEM Part # (No OEM Part # Available)

MALE CONNECTOR (3/8" TUBE x 3/8" MPT)

- 2 per package
 - Material: Brass
 - Included in: Unloader Valve (RPI Part #CMV121)
- Fits:** Unloader Valve

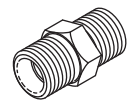

RPI Part #RPF833
OEM Part #77002055

ADAPTOR (1/4" MPT x 1/4" MPT)

- 2 per package
 - Material: Brass
 - Included in: Fresh Air Intake Filter Kit (RPI Part #CMK003)
 - Also available: Exhaust Silencer (RPI Part #CMS128)
- Fits:** Connects Exhaust Silencer to Solenoid Valve

FITTINGS (continued)

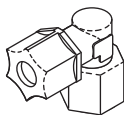

RPI Part #RPF835
OEM Part # (No OEM Part # Available)

ELBOW FITTING (3/8" TUBE x 3/8" FPT)

- Material: Durable Nylon®
- Included in: Collection Container Kit (RPI Part #CMK180)

Fits: Collection Container Kit (RPI Part #CMK180)



RPI Part #RPF857
OEM Part # (No OEM Part # Available)

ADAPTOR (1/4" FPT x 3/8" MPT)

- 2 per package
- Material: Brass
- Included in: Collection Container Kit (RPI Part #CMK180)

Fits: Collection Container Kit (RPI Part #CMK180)

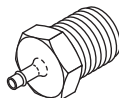

RPI Part #RPF914
OEM Part # (No OEM Part # Available)

ADAPTOR (1/16" BARB x 1/8" MPT)

- 5 per package
- Material: Brass
- Included in: Solenoid Valve (Regeneration System) (RPI Part #'s CMV250 & CMV251)

Fits: 1/16" ID Tubing x 1/8" FPT Ports

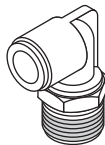

RPI Part #RXF024
OEM Part #003863SP; 56133

ELBOW (3/8" PUSH-IN x 3/8" MPT)

- 5 per package
- Material: Brass swivel fitting with plastic push-in chuck
- Included in: Check Valve Upgrade Kit (RPI Part #'s CMK247, CMK248 & CMK249)

Fits: 3/8" FPT Port and 3/8" OD Tubing

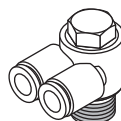

RPI Part #RXF025
OEM Part #56192

BRANCH ELBOW (DUAL 1/4" PUSH-IN x 1/4" MPT)

- Material: Brass fitting with dual plastic push-in elbow
- Included in: Check Valve Upgrade Kit (RPI Part #'s CMK247, CMK248 & CMK249)
- Also available: Tubing (.170" ID x 1/4" OD Natural) (RPI Part #RPT380)

Fits: 1/4" OD Tubing x 1/4" FPT Port

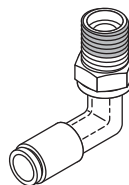

RPI Part #RXF029
OEM Part # (No OEM Part # Available)

ELBOW FITTING (1/4" PUSH-IN x 1/4" MPT)

- 2 per package
- Material: Brass swivel elbow with plastic push-in chuck
- Included in: Check Valve Upgrade Kit (RPI Part #'s CMK247, CMK248 & CMK249)
- Also available: Tubing (.170" ID x 1/4" OD Natural) (RPI Part #RPT380)

Fits: 1/4" FPT Port and 1/4" OD Tubing

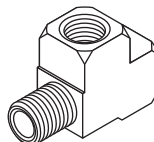

RPI Part #RXF030
OEM Part # (No OEM Part # Available)

STREET TEE (1/4" NPT)

- Material: Brass
- Included in: Check Valve Upgrade Kit (RPI Part #'s CMK247, CMK248 & CMK249)

Fits: 1/4" FPT and MPT Ports



RPI Part #RXF031
OEM Part # (No OEM Part # Available)

MALE CONNECTOR (1/4" PUSH-IN x 1/4" MPT)

- 2 per package
- Material: Brass with plastic push-in chuck
- Included in: Check Valve Upgrade Kit (RPI Part #CMK248)

Fits: 1/4" FPT Port and 1/4" OD Tubing

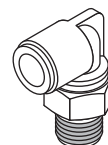

RPI Part #RXF033
OEM Part #56119

ELBOW FITTING (3/8" PUSH-IN x 1/4" MPT)

- 2 per package
- Material: Brass swivel fitting with plastic push-in chuck
- Included in: Check Valve Upgrade Kit (RPI Part #'s CMK247, CMK248 & CMK249)

Fits: 3/8" OD Tubing x 1/4" FPT Port

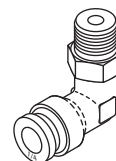

RPI Part #RXF037
OEM Part #56113

SWIVEL ELBOW (1/4" PUSH-IN x 1/8" MPT)

- 2 per package
- Material: Nickel plated brass swivel fitting with plastic push-in chuck
- Included in: Solenoid Valve (Regeneration System) (RPI Part #'s CMV250 & CMV251)

Fits: Regeneration Assembly

Air Techniques, Apollo/Midmark®, MDT McKesson, DentalEZ®/Custom Air/RamVac, Jun-Air, MatrX/Midmark®, Midmark®, Pelton & Crane, and Tech West/Turbine Ind.

OIL, COLLECTION CONTAINERS & MORE

RPI PART #	DESCRIPTION	AIR TECHNIQUES	APOLLO/MIDMARK®	DENTALEZ®/CUSTOM AIR/RAMVAC	JUN-AIR	MATR/MIDMARK®	MDT MCKESSON	MIDMARK®	PELTON & CRANE	TECH WEST
CMK180	COLLECTION CONTAINER KIT Use with Pressurized Purge Systems		AKCSL100D	SPA95400		AMD-100 CL-10		CL21 P21		ACL2S1
CMK181	COLLECTION CONTAINER KIT Use with Gravity Drain Systems		AKCSL100D AOCOS11D	SPA95400		AMD-100 CL-10		CL21 P21		ACL2S1
CML001	COMPRESSOR OIL - (1) 16 oz. bottle	60051 (1) 16 oz. bottle	ACA85921 (1) 16 oz. bottle	64651001 (1) 16 oz. bottle		77000220 (1) 16 oz. bottle	3-08-0084-30 (1) 16 oz. bottle	No OEM Part # Available	No OEM Part # Available	CO-100 (1) 16 oz. bottle
CML045	COMPRESSOR OIL (CASE) - (12) 16 oz. bottles	60051 (1) 16 oz. bottle	ACA85921 (1) 16 oz. bottle	64651001 (1) 16 oz. bottle		77000220 (1) 16 oz. bottle	3-08-0084-30 (1) 16 oz. bottle	No OEM Part # Available	No OEM Part # Available	CO-100 (1) 16 oz. bottle
CML119	SYNTHETIC COMPRESSOR OIL - (1) 16 oz. bottle			JA64651-004 (1) 16 oz. bottle	64651-004 (1) 16 oz. bottle					
CML120	SYNTHETIC COMPRESSOR OIL (CASE) (12) 16 oz. bottles			JA64651-004 (1) 16 oz. bottle	64651-004 (1) 16 oz. bottle					
RPB838	DISPOSAL BAG	No OEM Part # Available	No OEM Part # Available	No OEM Part # Available	No OEM Part # Available	No OEM Part # Available	No OEM Part # Available	No OEM Part # Available	No OEM Part # Available	No OEM Part # Available
RPB939	BOTTLE (1 Liter / 32 fl. oz.)	No OEM Part # Available	No OEM Part # Available	No OEM Part # Available	No OEM Part # Available	No OEM Part # Available	No OEM Part # Available	No OEM Part # Available	No OEM Part # Available	No OEM Part # Available
RPP958	ABSORBENT PAD - 3/PKG	No OEM Part # Available	No OEM Part # Available	No OEM Part # Available	No OEM Part # Available	No OEM Part # Available	No OEM Part # Available	No OEM Part # Available	No OEM Part # Available	No OEM Part # Available
RPT842	SYRINGE PUMP/EXTRACTOR	No OEM Part # Available	No OEM Part # Available	No OEM Part # Available	No OEM Part # Available	No OEM Part # Available	No OEM Part # Available	No OEM Part # Available	No OEM Part # Available	No OEM Part # Available
RPV841	DRAIN VALVE		PVV50525 (Plug)			No OEM Part # Available	No OEM Part # Available			No OEM Part # Available

RPI Part #CML001
OEM Part #'s - See Chart Above

COMPRESSOR OIL

- 16 oz. (0.75L) bottle; ISO100
- Includes: Extended Yorker Spout
- For use with most Copeland® head compressors
- Included in: Compressor PM Kits (see pages 400-402)



RPI Part #CML119
OEM Part #'s - See Chart Above

SYNTHETIC COMPRESSOR OIL

- 16 oz. (0.75L) bottle; ISO Grade 46; Equivalent to SJ-27F
- Includes: Extended Yorker Spout
- Included in: Compressor PM Kits (see page 400)



Also available by the Case - (12) 16 oz. Bottles!
COMPRESSOR OIL (CASE)
RPI Part #CML045

Also available by the Case - (12) 16 oz. Bottles!
SYNTHETIC COMPRESSOR OIL (CASE)
RPI Part #CML120

Great for compressor waste water and oil collection and disposal!

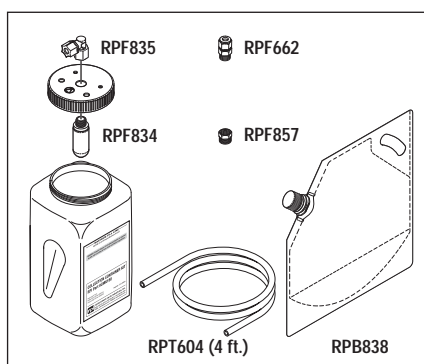

RPI Part #CMK180
OEM Part #'s - See Chart Above

COLLECTION CONTAINER KIT

- For use with Pressurized Purge Systems
- Tubing can be cut to desired length depending on proximity of compressor to collection container
- **It's the RPI Advantage!** This one-of-kind collection bottle can replace the purge drain lines and be directly connected with tubing to the compressor so that the purge waste water and oil can be collected and disposed of properly according to local, state and federal regulations.

Fits: Purge Assembly

Models: All Lubricated Compressors with Pressurized Purge Systems

Great for compressor waste water and oil collection and disposal!

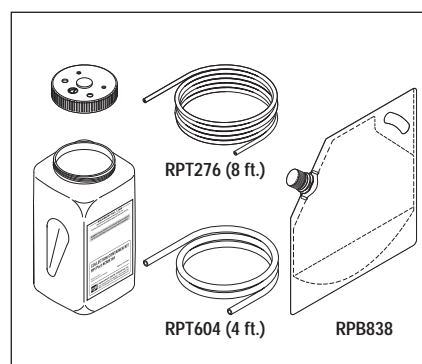

RPI Part #CMK181
OEM Part #'s - See Chart Above

COLLECTION CONTAINER KIT

- For use with Gravity Drain Systems
- Tubing can be cut to desired length depending on proximity of compressor to collection container
- Accommodates up to 2 ea. 1/4" dia. tubing and 1 ea. 3/8" dia. tubing
- **It's the RPI Advantage!** This one-of-kind collection bottle can replace the purge drain lines and be directly connected with tubing to the compressor so that the purge waste water and oil can be collected and disposed of properly according to local, state and federal regulations.

Fits: Purge Assembly

Models: All Lubricated Compressors with Gravity Drain systems

OIL, COLLECTION CONTAINERS & MORE (continued)

5 ESSENTIAL TOOLS FOR AN EASIER OIL CHANGE!

1 **SYRINGE PUMP/EXTRACTOR (RPI Part #RPT842)**

This one-of-a-kind tool allows complete removal of oil from a compressor without needing to tilt or disassemble the unit!

2 **DRAIN VALVE (RPI Part # RPV841)**

Upgrade to RPI's one-of-a-kind Drain Valve which has a special Tee-handle that allows you to easily open and close the valve to control the flow of oil as it is draining into the Disposal Bag!

3 **DISPOSAL BAG (RPI Part #RPB838) OR BOTTLE (RPI Part #RPB939)**

Either the Disposable Bag with expandable base and built in handle (1 gallon), or the Bottle (1 liter) is the perfect solution for carrying, storing and disposing of used oil. Both the bag and bottle are constructed of durable clear plastic, and include a tight sealing cap.

4 **COLLECTION CONTAINER KITS (RPI Part #'s CMK180 & CMK181) - shown on page 429**

These one-of-kind collection bottles can replace the purge drain lines and be directly connected with tubing to the compressor so that the purge waste water and oil can be collected and disposed of properly according to local, state and federal regulations.

5 **ABSORBENT PAD (RPI Part #RPP958)**

This 9-1/4" x 14-1/2" pad is perfect for oil drip collection and spills and is sold in a package of 3!

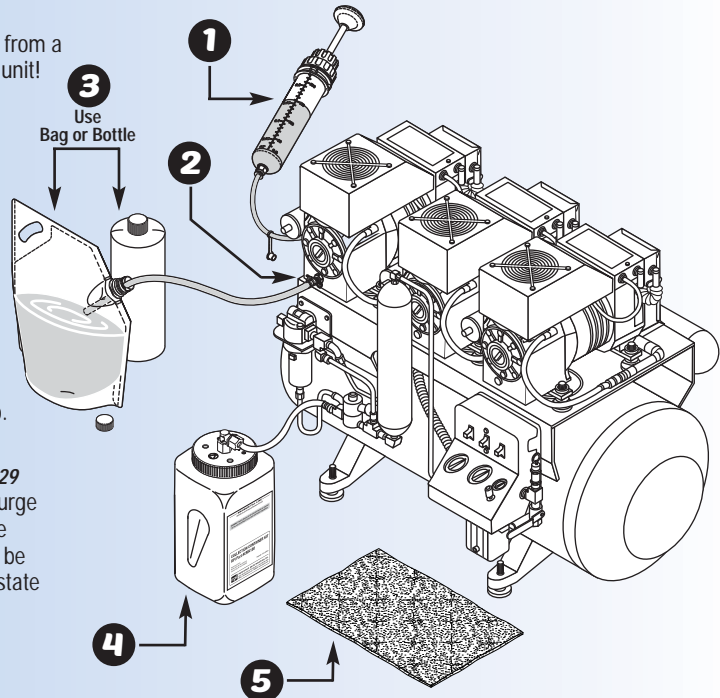

1 *It's the RPI Advantage! This one-of-a-kind tool allows complete removal of oil from a compressor without needing to tilt or disassemble the unit.*

RPI Part #RPT842
OEM Part # (No OEM Part # Available)

SYRINGE PUMP/EXTRACTOR

- 200 CC capacity, clear body
- Includes all parts as shown
- Also available: Cap (RPI Part #RPC847), and Seal Kit (RPI Part #RPK846)

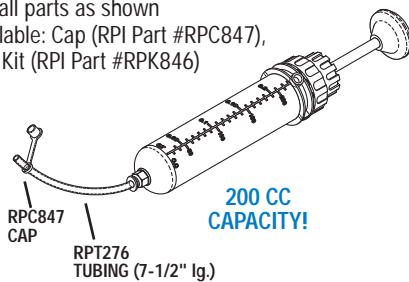

2 *It's the RPI Advantage! Replace the existing drain plug with RPI's new, one-of-a-kind Drain Valve to make your next oil change a breeze. RPI's Drain Valve has a special Tee-handle that allows you to easily open and close the valve to control the flow of oil as it is draining into the disposal bag (RPI Part #RPB838) or Bottle (RPI Part #RPB939).*

RPI Part #RPV841
OEM Part #PVV50525

DRAIN VALVE

- Tee handle: Material: Brass body/Steel handle • Size: 1/8" MPT • Includes all parts as shown • Also available: 1/4" Teflon Thread Sealing Tape (RPI Part #RPT579) and Tubing (5/16" ID x 7/16" OD Clear) (RPI Part #RPT849) - sold by the foot

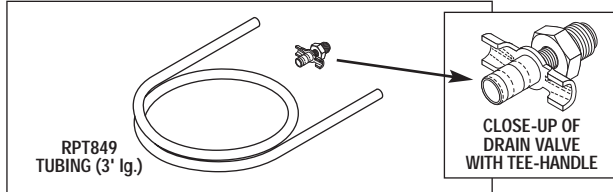

USE THE BOTTLE OR BAG FOR COLLECTION & DISPOSAL!

RPI Part #RPB939
OEM Part # (No OEM Part # Available)

BOTTLE

- (1 Liter / 32 fl. oz.)
- Can be used for used oil collection
- 3-3/4" OD x 8.00" tall
- Material: HDPE plastic
- Clear durable plastic bottle with tight sealing cap



3 RPI Part #RPB838
OEM Part # (No OEM Part # Available)

DISPOSAL BAG (1 Gallon)

- Can be used for used oil collection
- 3 per package
- Clear durable plastic bag with tight sealing cap, built in handle and expandable base

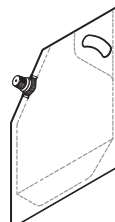

RPI Part #CMK180 & RPI Part #CMK181
OEM Part #SPA95400

COLLECTION CONTAINER KITS

- See page 429 for a complete description of these RPI Kits

RPI Part #RPP958
OEM Part # (No OEM Part # Available)

ABSORBENT PAD

- Can be used for oil drip collection and spills
- 3 per package

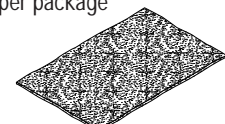

Size: 9-1/4" x 14-1/2"

Call Us Toll-Free Monday-Friday, 8:00 AM-4:30 PM (Pacific Time), (800) 221-9723

Air Techniques, Apollo/Midmark®, MDT McKesson, DentalEZ®/Custom Air/RamVac, Jun-Air, Matrix/Midmark®, Midmark®, Pelton & Crane, and Tech West/Turbine Ind.

POWER SWITCHES & CIRCUIT BREAKERS

RPI Part #PCS643
OEM Part #011290

POWER SWITCH ASSEMBLY

- 20A @ 250VAC
- (On/Off) toggle switch; SPDT
- Fits 1/2" dia. mounting hole
- Includes mounting hardware

Fits: Electrical Box

Models: 420-C (Serial #22302 and above)
& 840-C (Serial #4530 and above)

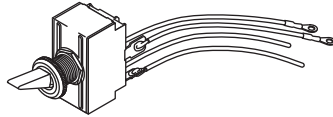

RPI Part #VPS177
OEM Part #85838

POWER SWITCH

- Toggle switch (On/Off)
- 20A @ 120/277VAC, SPDT
- Screw terminals
- See **Note** below for quantity required for each model

Fits: Electrical Control Box

Models: AirStar 10, AirStar 100M, AirStar 10D, AirStar 21, AirStar 21D, AirStar 22, AirStar 22D, AirStar 30, AirStar 30D, AirStar 30M, AirStar 40, AirStar 40M, AirStar 50, AirStar 50D, AirStar 50M, AirStar 70, AirStar 70D, AirStar 70M, VacStar 50, VacStar 50H, VacStar 80 & VacStar 80H

Note: Air Techniques: AirStar 10D, AirStar 21D and AirStar 22D requires (1) power switch. AirStar 30D, AirStar 30M, AirStar 40M, AirStar 50D, AirStar 50M and AirStar 100M requires (2) power switches. AirStar 70D and AirStar 70M requires (3) power switches.

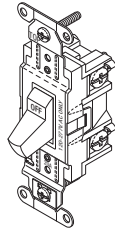

RPI Part #CMS209
OEM Part #86065 & 86063

POWER SWITCH/ CIRCUIT BREAKER (10A)

- On/Off power switch
- 10A @ 250VAC
- #10-32 screw terminals

Fits: Electrical Control Box

Models: AirStar 10M, AirStar 10D (May 2006 to Current), AirStar 30M (May 2006 to Current) & AirStar 30D (May 2004 to Current)

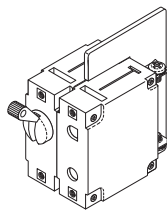

RPI Part #CMS210
OEM Part #56148

POWER SWITCH/ CIRCUIT BREAKER (8A)

- On/Off power switch
- 8A @ 250VAC
- #10-32 screw terminals

Fits: Electrical Control Box

Models: AirStar 12M, AirStar 22M, AirStar 22D, VacStar 50 & VacStar 50H

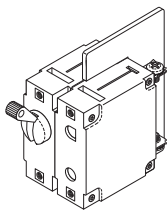

RPI Part #CMS212
OEM Part #86064

POWER SWITCH/ CIRCUIT BREAKER (15A)

- On/Off power switch
- 15A @ 250VAC
- #10-32 screw terminals

Fits: Electrical Control Box

Models: AirStar 40M, AirStar 50M & AirStar 50D (May 2006 to Current)

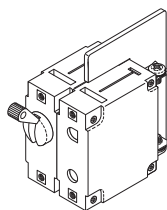

RPI Part #CMS213
OEM Part #86066

POWER SWITCH/ CIRCUIT BREAKER (22A)

- On/Off power switch
- 22A @ 250VAC
- #10-32 screw terminals

Fits: Electrical Control Box

Models: AirStar 70M (May 2006 to Current) & AirStar 70D (May 2006 to Current)

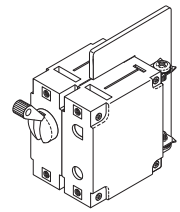

RPI Part #CMS214
OEM Part #85367

POWER SWITCH/ CIRCUIT BREAKER (8A)

- On/Off power switch
- 8A @ 250VAC
- #8-32 screw terminals

Fits: Electrical Control Box

Models: AirStar 70M (1996 to April 2006) & AirStar 70D (1996 to April 2006)

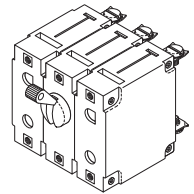

RPI Part #CMS215
OEM Part #85363

POWER SWITCH/ CIRCUIT BREAKER (5A)

- On/Off power switch
- 5A @ 250VAC
- #8-32 screw terminals

Fits: Electrical Control Box

Models: AirStar 30D (1996 to April 2004)

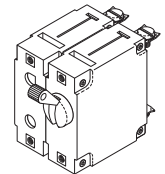

RPI Part #VPB164
OEM Part #117690

CIRCUIT BREAKER (1/4A)

- 1/4A @ 250VAC
- 1/4" tabs
- Panel Cutout: 5/8" dia.
- Push to reset

Fits: Electrical Control Box

Models: AirStar 10D, AirStar 12M, AirStar 21D, AirStar 21M, AirStar 22D, AirStar 22M, AirStar 30D, AirStar 30M, AirStar 40M, AirStar 50D, AirStar 50M, AirStar 70D, AirStar 70M & AirStar 100M

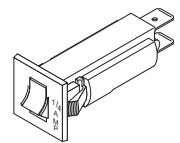

RPI Part #VPB182
OEM Part #117061

CIRCUIT BREAKER (1/2A)

- 1/2A @ 250VAC
- 1/4" tabs
- Panel Cutout: 5/8" dia.
- Push to reset

Fits: Electrical Control Box

Models: AirStar 10D, AirStar 10M, AirStar 21D, AirStar 22D, AirStar 30D, AirStar 50D & AirStar 70D

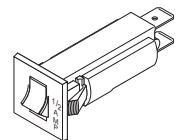

RELAYS

RPI PART #	DESCRIPTION	AIR TECHNIQUES	APOLLO/MIDMARK®	DENTALEZ®/CUSTOM AIR/RAMVAC	MATRX/MIDMARK®	MIDMARK®	PELTON & CRANE	TECH WEST
CMR032	RELAY (UNIVERSAL)	60501 62501 64501 66501	HCA30652 HCA30653 HCA30654 HCA30655	Included in 645011010 & 645011011	Included in 77001344 77001345 & 77001346	Included in 77001345 & 77001346		PR-115 PR-208
CMR200	RELAY (ELECTRICAL CONTACTOR)	89345 & 85773						
PCR635	RELAY						005172 & 004843	
VPR151	RELAY (ELECTRICAL CONTACTOR)	54498						

RPI Part #CMR032
OEM Part #'s - See Chart Above

RELAY (UNIVERSAL)

- Size: 2.00" L x 1.84" W x 1.30" H
- Universal mounting configuration
- 110-270VAC single phase
- Max voltage contact rating: 502VAC
- Motor power rating: up to 10HP
- Includes: .25" quick connect tabs, and (6x) tab to screw adaptors

Fits: Start Box

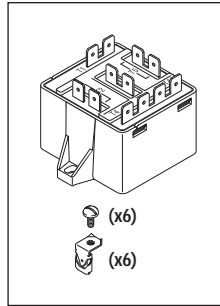

RPI Part #VPR151
OEM Part #'s - See Chart Above

RELAY (ELECTRICAL CONTACTOR)

- Size: 2-1/2" L x 2-3/8" W x 2.91" H
- Coil: 24VAC, 7 ohms
- 3 pole; Contacts rated at 40A
- 1/4" Tabs

Fits: Electrical Control Box

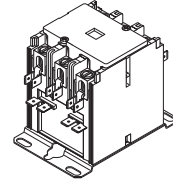

RPI Part #CMR200
OEM Part #'s - See Chart Above

RELAY (ELECTRICAL CONTACTOR)

- Size: 2-3/8" L x 2-1/2" W x 2.91" H
- Coil: 24VAC, 7 ohms
- 2 pole, contacts rated at 40A
- 1/4" Tabs

Fits: Electrical Control Box

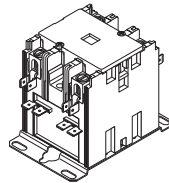

RPI Part #PCR635
OEM Part #'s - See Chart Above

RELAY

- Size: 2.00" L x 1-3/4" W x 1-9/16" H
- 115VAC/220VAC (3ARR3-63)
- #8-32 screw terminals (1/4" tabs)

Fits: Electrical Control Box

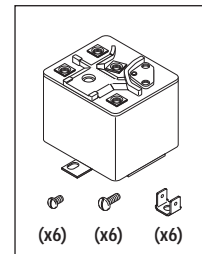

TRANSFORMERS



RPI Part #VPT142
OEM Part #85934, 86637, 85275 & 85362

TRANSFORMER

- Size: 2-5/8" L x 2-3/16" W x 2-3/16" H
- Primary: 120/208/240VAC; 50/60Hz.
- Secondary: 24VAC @ 40A
- Includes all parts as shown
- 1/4" Tabs

Fits: Electrical Control Box

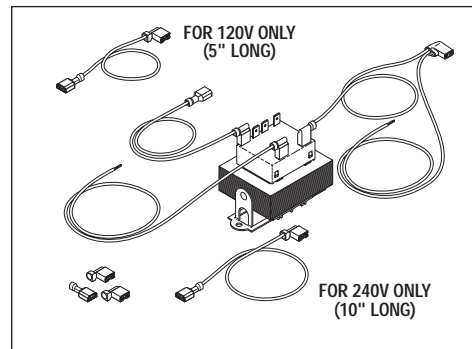

NOTES: _____

Air Techniques, Apollo/Midmark®, MDT McKesson, DentalEZ®/Custom Air/RamVac, Jun-Air, MatrX/Midmark®, Midmark®, Pelton & Crane, and Tech West/Turbine Ind.

PRESSURE SWITCHES & VALVES

RPI PART #	DESCRIPTION	AIR TECHNIQUES	APOLLO/MIDMARK®	DENTAL EZ®/CUSTOM AIR/RAMVAC	JUN-AIR	TECH WEST
CMS051	PRESSURE SWITCH		ECS10445			
CMS052	PRESSURE SWITCH		ECS10455			
CMS053	PRESSURE SWITCH					PCS-3
CMS054	PRESSURE SWITCH			JA5074800		
CMS055	PRESSURE SWITCH				JA5075200	
CMV058	UNLOADER VALVE				No OEM Part # Available	
CMV059	PRESSURE RELIEF VALVE	No OEM Part # Available	PW05526			
CMV060	PRESSURE RELIEF VALVE		No OEM Part # Available			
RPO303	O-RING				No OEM Part # Available	
RPT670	TUBING (4 mm ID x 6 mm OD Black)				No OEM Part # Available	

RPI Part #CMS051
OEM Part # - See Chart Above

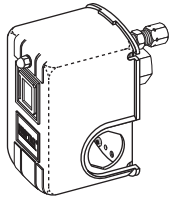

PRESSURE SWITCH

- 115/230VAC
- Contacts: N.C. SPDT
- Factory set to: Off @ 100 PSI
- 3/8" FPT Input port
- Includes: 2-way Pressure Relief Valve (RPI Part #CMV060)

RPI Part #CMV060
OEM Part # - See Chart Above

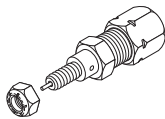

PRESSURE RELIEF VALVE

- Brass
- Fits 1/4" dia. mounting hole
- Includes: 1/4" Tubing Compression Nut, Ferrule and mounting hardware

RPI Part #CMS052
OEM Part # - See Chart Above

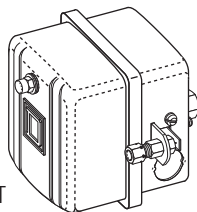

PRESSURE SWITCH

- 115/230VAC
- Contacts: N.C. SPDT
- Factory set to: On @ 75 PSI - Off @ 100 PSI
- 1/4" FPT Input port
- Includes: 2-way Pressure Relief Valve (RPI Part #CMV059)

RPI Part #CMV059
OEM Part # - See Chart Above

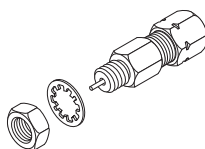

PRESSURE RELIEF VALVE

- Brass
- Fits 5/16" dia. mounting hole
- Includes: 1/4" Tubing Compression Nut, Ferrule and mounting hardware

RPI Part #CMS053
OEM Part # - See Chart Above

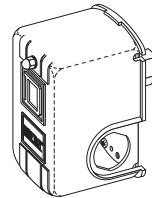

PRESSURE SWITCH

- 115/230VAC
- Contacts: N.C. SPDT
- Factory set to: On @ 80 PSI - Off @ 100 PSI
- 1/4" FPT Input port

RPI Part #CMS054
OEM Part # - See Chart Above

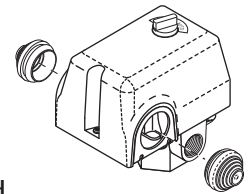

PRESSURE SWITCH

- 115/230VAC
- Contacts: N.C. SPDT
- Factory set to: On @ 90 PSI (6.2 Bar) - Off @ 116 PSI (8.0 Bar)
- 4-port 1/4" BSP manifold
- Auto/Off control
- Includes (2) Cable Grommets

RPI Part #CMS055
OEM Part #'s - See Chart Above

PRESSURE SWITCH

- 115/230VAC
- Contacts: N.C. SPDT
- Factory set to: On @ 90 PSI (6.2 Bar) - Off @ 116 PSI (8.0 Bar)
- 1/4" BSPP manifold port
- Auto/Off control
- Includes: Unloader Valve (RPI Part #CMV058), 40" Tubing (RPI Part #RPT670), Tube Adaptor Fitting, Elbow Fitting, Conduit Connectors and Quick Connect Fitting with O-ring (RPI Part #RPO303)

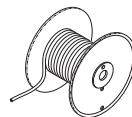
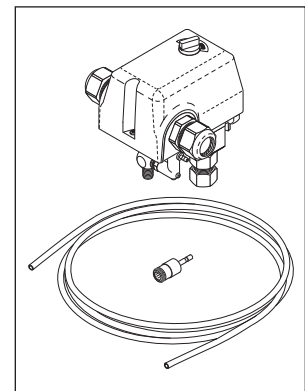

RPI Part #RPT670
OEM Part #'s - See Chart Above

TUBING (4 mm ID x 6 mm OD Black)

- Sold by the foot (reel not included)
- Polyurethane tubing
- Fits: 4mm Barbs or 6mm Push-In Fittings



ACTUAL SIZE

RPI Part #RPO303
OEM Part #'s - See Chart Above

O-RING

- 12 per package
- Size: .364" ID x .504" OD x .070" C/S
- Material: Nitrile (Buna N); Duro: 70
- Fits: Pressure Switch Quick Connect Fitting

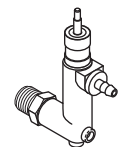

RPI Part #CMV058
OEM Part #'s - See Chart Above

UNLOADER VALVE

- Plastic body; 1/8" BSP
- 4mm barb fitting

PRESSURE SWITCHES & VALVES *(continued)*

RPI PART #	DESCRIPTION	AIR TECHNIQUES	APOLLO/MIDMARK®	MATRX/MIDMARK®	MIDMARK®
CMS056	PRESSURE SWITCH	85465			
CMS057	PRESSURE SWITCH	60016			
CMS131	PRESSURE SWITCH			77005143	77005143
CMS208	PRESSURE SWITCH	85979, 87176 & 86436		77005143	77005143
CMV059	PRESSURE RELIEF VALVE	No OEM Part # Available	PV05526		

RPI Part #CMS057
OEM Part # -
See Chart Above

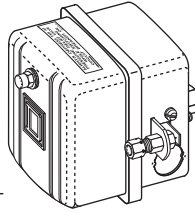

PRESSURE SWITCH

- 115/230VAC
- Contacts: N.C. SPDT
- Factory set to:
On @ 80 PSI - Off @ 100 PSI
- 1/4" FPT Input port w/orifice
- Includes: 2-way Pressure Relief Valve (RPI Part #CMV059)

RPI Part #CMS056
OEM Part # - See
Chart Above

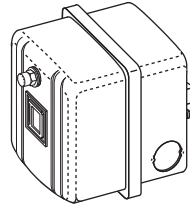

PRESSURE SWITCH

- 115/230VAC
- Contacts: N.C. SPDT
- Factory set to:
On @ 80 PSI - Off @ 100 PSI
- 1/4" FPT Input port

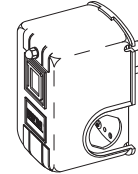

RXT017
(11" lg.)

RPI Part #CMS208
OEM Part # - See Chart Above

PRESSURE SWITCH

- 115/230VAC
- Contacts: N.C. DPST
- Factory set to:
On @ 85 PSI - Off @ 115 PSI
- 1/4" NPSF input port
- Includes: 11" Tubing (6.5mm ID x 10mm OD Black) (RPI Part #RXT017)

RPI Part #CMV059
OEM Part # -
See Chart Above

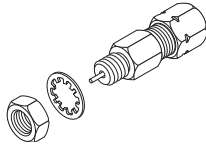

PRESSURE RELIEF VALVE

- Brass
- Fits 5/16" dia. mounting hole
- Includes: 1/4" Tubing Compression Nut, Ferrule and mounting hardware

RPI Part #CMS131
OEM Part # - See
Chart Above

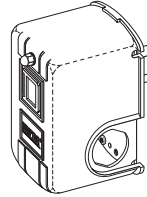

PRESSURE SWITCH

- 115/230VAC
- Contacts: N.C. DPST
- Factory set to: On @ 80 PSI - Off @ 100 PSI
- 1/4" FPT input port

PRESSURE GAUGES

RPI PART #	DESCRIPTION	AIR TECHNIQUES	APOLLO/MIDMARK®	DENTAL EZ®/CUSTOM AIR/RAMVAC	JUN-AIR	MATRX/MIDMARK®	MDT McKESSON	MIDMARK®	TECH WEST
CMG048	PRESSURE GAUGE (160 PSI)	60011	PCA70400			77005012		20150201	CPG-250
CMG049	PRESSURE GAUGE (300 PSI)	No OEM Part # Available	No OEM Part # Available	No OEM Part # Available	No OEM Part # Available	No OEM Part # Available	No OEM Part # Available	No OEM Part # Available	No OEM Part # Available
CMG050	PRESSURE GAUGE (230 PSI)				JA5130000				
RPT579	1/4" TEFLON THREAD SEALING TAPE	No OEM Part # Available	No OEM Part # Available	No OEM Part # Available	No OEM Part # Available	No OEM Part # Available	No OEM Part # Available	No OEM Part # Available	No OEM Part # Available

RPI Part #CMG048
OEM Part #'s - See Chart Above

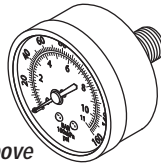

PRESSURE GAUGE (160 PSI)

- 2" dial; Polycarbonate lens
- Dual scale: 0-160 PSI & 0-11 Bar
- 1/4" MPT center back mount

RPI Part #CMG050
OEM Part #'s - See Chart Above

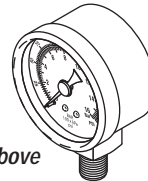

PRESSURE GAUGE (230 PSI)

- 1.5" dial; Polycarbonate lens
- Dual scale: 0-230 PSI & 0-16 Bar
- 1/8" BSPP bottom mount

RPI Part #CMG049
OEM Part #'s - See Chart Above

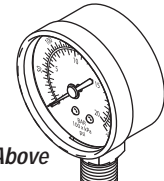

PRESSURE GAUGE (300 PSI)

- 2" dial; Polycarbonate lens
- Dual scale: 0-300 PSI & 0-20.6 Bar
- 1/4" MPT bottom mount

Don't forget the Teflon® Tape for use with the pressure gauges!

RPI Part #RPT579
OEM Part #'s - See Chart Above
1/4" TEFLON THREAD SEALING TAPE

- 5 per package
- 1/4" x 260" per unit



Air Techniques, Apollo/Midmark®, MDT McKesson, DentalEZ®/Custom Air/RamVac, Jun-Air, MatrX/Midmark®, Midmark®, Pelton & Crane, and Tech West/Turbine Ind.

SAFETY VALVES

RPI PART #	DESCRIPTION	AIR TECHNIQUES	APOLLO/MIDMARK®	JUN-AIR	MATR/MIDMARK®	MDT McKESSON	MIDMARK®	TECH WEST
CMV046	SAFETY VALVE (125 PSI)	60017	PVV50560		77005020	3-08-0813-00	77005020	POVA-100
CMV047	SAFETY VALVE (135 PSI)			JA5417000				

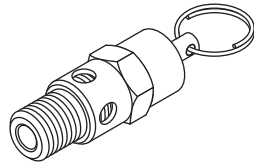

RPI Part #CMV046
OEM Part # - See Chart Above
SAFETY VALVE (125 PSI)
 • Brass; 1/4" MPT
 • Cracking pressure: 125 PSI

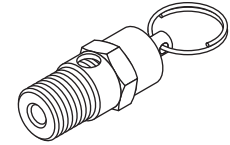

RPI Part #CMV047
OEM Part # - See Chart Above
SAFETY VALVE (135 PSI)
 • Brass; 1/4" BSPP
 • Cracking pressure: 135 PSI

SIGHT GLASSES & SIGHT GLASS TOOL

RPI PART #	DESCRIPTION	AIR TECHNIQUES	APOLLO/MIDMARK®	MATR/MIDMARK®	MDT McKESSON	MIDMARK®	PELTON & CRANE	TECH WEST
CMK097	SIGHT GLASS KIT	60100	ACA85322 & ASA85322	77000812	3-08-0012-10			OSG-100
CMK098	SIGHT GLASS KIT	60100	ACA85322	77000812	3-08-0012-10 Sight Glass Only			OSG-100
PCG634	SIGHT GLASS (OIL)						60100	
RPT705	SIGHT GLASS TOOL	No OEM Part # Available	ACA00050	No OEM Part # Available	301789	No OEM Part # Available		No OEM Part # Available

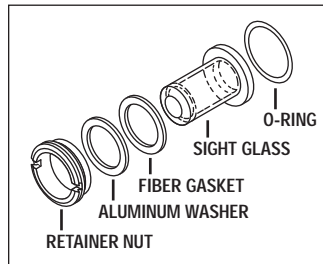

RPI Part #CMK097
OEM Part #'s - See Chart Above
SIGHT GLASS KIT
 • Includes all parts as shown
 • Also available: Sight Glass Tool (RPI Part #RPT705)
Fits: Copeland head lubricated compressors

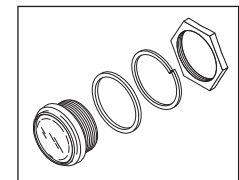

RPI Part #PCG634
OEM Part # - See Chart Above
SIGHT GLASS (OIL)
 • Glass lens
 • Includes seal and mounting hardware
 • No Sight Glass Tool required
Fits: Motor Housing

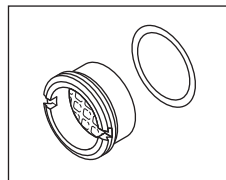

RPI Part #CMK098
OEM Part #'s - See Chart Above
SIGHT GLASS KIT
 • Steel retainer body with built in sight glass
 • Includes all parts as shown
 • Also available: Sight Glass Tool (RPI Part #RPT705)
Fits: Copeland head lubricated compressors

DON'T FORGET THE SIGHT GLASS TOOL!

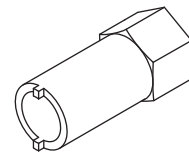

RPI Part #RPT705
OEM Part #'s - See Chart Above
SIGHT GLASS TOOL
 • For easy removal and installation of sight glasses
Fits: Copeland head lubricated compressors

SOLENOID VALVES & REPAIR KITS

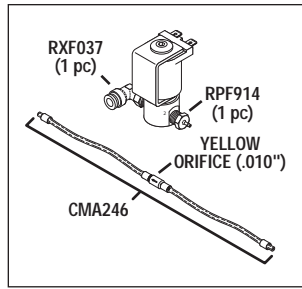

RPI Part #CMV250
OEM Part #85839

**SOLENOID VALVE
(REGENERATION SYSTEM)**

- 24/60VAC, 50Hz., 8.5W; 1/4" tabs, (8.6 Ohms)
- Ports: 1/8" FPT; 2-way; N.C.
- Includes: Orifice Assembly (.010") (RPI Part #CMA246), Swivel Elbow (1/4" Push-In x 1/8" MPT) (RPI Part #RXF037), and Adaptor (1/16" Barb x 1/8" MPT) (RPI Part #RPF914)
- Also available: Solenoid Valve Repair Kit, (RPI Part #VPK006), 1/8" Sleeve Tool (RPI Part #RPT294), and Universal Sleeve Tool (RPI Part #RPT296)

Fits: Regeneration System

Models: AirStar 50D and AirStar 70D

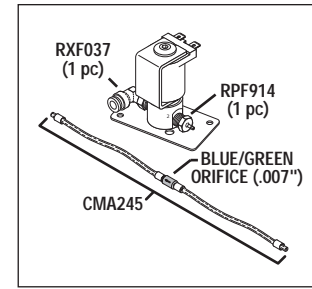

RPI Part #CMV251
OEM Part #85834

**SOLENOID VALVE
(REGENERATION SYSTEM)**

- 24/60VAC, 50Hz., 8.5W; 1/4" tabs, (8.6 Ohms)
- Ports: 1/8" FPT; 2-way; N.C.
- Includes: Orifice Assembly (.007") (RPI Part #CMA245), Swivel Elbow (1/4" Push-In x 1/8" MPT) (RPI Part #RXF037), Adaptor (1/16" Barb x 1/8" MPT) (RPI Part #RPF914), and mounting bracket
- Also available: Solenoid Valve Repair Kit, (RPI Part #VPK006), 1/8" Sleeve Tool (RPI Part #RPT294), and Universal Sleeve Tool (RPI Part #RPT296)

Fits: Regeneration System

Models: AirStar 10D, AirStar 21D, AirStar 22D & AirStar 30D

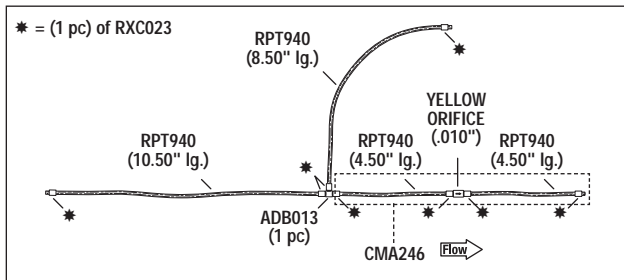

RPI Part #CMA252
OEM Part #89185



**REGENERATION
ORIFICE ASSEMBLY**

- Includes: Orifice Assembly (.010") (RPI Part #CMA246), 28" Tubing (1/16" ID x 1/8" OD Clear) (RPI Part #RPT940), (8 pc) Sleeve Clamp (1/8") (RPI Part #RXC023), and (1 pc) Barb Tee (RPI Part #ADB013)
- Also available: 1/8" Sleeve tool (RPI Part #RPT294) and Universal Sleeve Tool (RPI Part #RPT296)

Fits: Purge System

Models: AirStar 50D & AirStar 70D

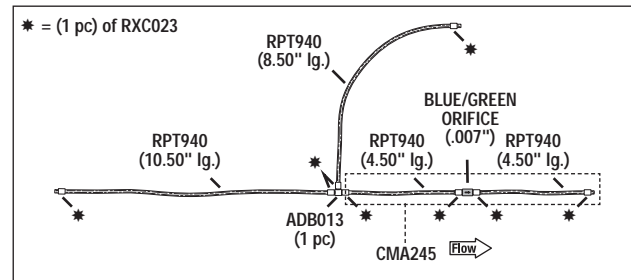

RPI Part #CMA253
OEM Part #89183



**REGENERATION
ORIFICE ASSEMBLY**

- Includes: Orifice Assembly (.007") (RPI Part #CMA245), 28" Tubing (1/16" ID x 1/8" OD Clear) (RPI Part #RPT940), (8 pc) Sleeve Clamp (1/8") (RPI Part #RXC023) and (1pc) Barb Tee (RPI Part #ADB013)
- Also available: 1/8" Sleeve tool (RPI Part #RPT294) and Universal Sleeve Tool (RPI Part #RPT296)

Fits: Purge system

Models: AirStar 10D, AirStar 21D, AirStar 22D & AirStar 30D

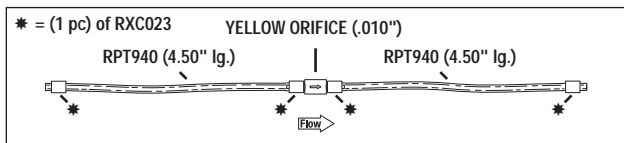

RPI Part #CMA246
OEM Part #85412



ORIFICE ASSEMBLY (.010")

- Orifice .010"
- Includes: Orifice, Tubing (1/16" ID x 1/8" OD Clear) (RPI Part #RPT940), and (4 pc) Sleeve Clamp (1/8") (RPI Part #RXC023)
- Also available: 1/8" Sleeve tool (RPI Part #RPT294) and Universal Sleeve Tool (RPI Part #RPT296)

Fits: Purge System

Models: AirStar 50D & AirStar 70D

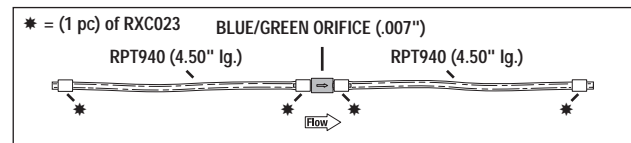

RPI Part #CMA245
OEM Part #85411



ORIFICE ASSEMBLY (.007")

- Orifice .007"
- Includes: Orifice, Tubing (1/16" ID x 1/8" OD Clear) (RPI Part #RPT940), and (4 pc) Sleeve Clamp (1/8") (RPI Part #RXC023)
- Also available: 1/8" Sleeve tool (RPI Part #RPT294) and Universal Sleeve Tool (RPI Part #RPT296)

Fits: Purge System

Models: AirStar 10D, AirStar 21D, AirStar 22D & AirStar 30D

Air Techniques, Apollo/Midmark®, MDT McKesson, DentalEZ®/Custom Air/RamVac, Jun-Air, MatrX/Midmark®, Midmark®, Pelton & Crane, and Tech West/Turbine Ind.

SOLENOID VALVES & REPAIR KITS (continued)

RPI PART #	DESCRIPTION	AIR TECHNIQUES	DENTALEZ®/ CUSTOM AIR/RAMVAC
CMK258	SOLENOID VALVE REPAIR KIT		No OEM Part # Available
CMK260	SOLENOID VALVE REPAIR KIT		No OEM Part # Available
CMM237	PURGE MUFFLER		004088
CMM238	PURGE MUFFLER		005082
CMM261	PURGE MUFFLER		004856
CMV255	SOLENOID VALVE		004980
CMV257	SOLENOID VALVE		8801-024
CMV259	SOLENOID VALVE		8801-025
VPK006	SOLENOID VALVE REPAIR KIT	No OEM Part # Available	
TUC084	WIRE CONNECTOR WITH GASKET <i>Available but not shown on this page</i>		No OEM Part # Available

RPI Part #CMV255
OEM Part #'s - See
Chart Above

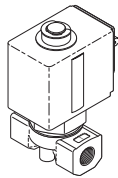

SOLENOID VALVE

- 24VDC; 4 1/2 W; (128 Ohms)
- Ports: 1/8" FPT; 2-Way; N.O.
- Also available: Purge Muffler (RPI Part #CMM261), and Wire Connector with Gasket (RPI Part #TUC084)

Fits: Dryer Assembly

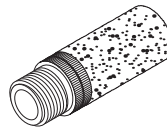

RPI Part #CMM261
OEM Part #'s - See
Chart Above

PURGE MUFFLER

- Size: .51" OD x 1.50" lg.
- Port Size: 1/8" NPT
- Material: Sintered copper alloy

Fits: Dryer Assembly

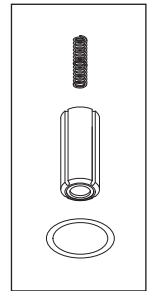

RPI Part #VPK006
OEM Part #'s - See
Chart Above

SOLENOID VALVE REPAIR KIT

- Includes all parts as shown
- Also available: Solenoid Valve (Regeneration System) (RPI Part #'s CMV250 & CMV251) see page 436

Fits: Solenoid Valve (Regeneration System)

RPI Part #CMV257
OEM Part #'s - See
Chart Above

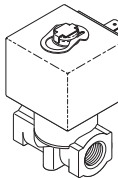

SOLENOID VALVE

- 24VAC 50/60 Hz., 8W (10 Ohms)
- Ports: 1/4" FPT; 2-Way; N.C.
- **Note:** There are 2 solenoid valves per unit
- Also available: Solenoid Valve Repair Kit (RPI Part #CMK258), Purge Muffler (RPI Part #CMM237), and Wire Connector with Gasket (RPI Part #TUC084)

Fits: Dryer Assembly

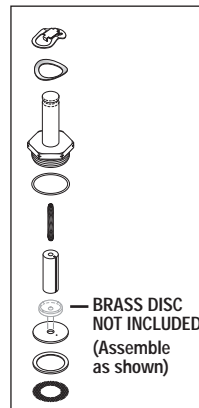

RPI Part #CMK258
OEM Part #'s - See
Chart Above

SOLENOID VALVE REPAIR KIT

- Buna-N Seal
- Includes all parts as shown
- **Note:** There are 2 solenoid valves per unit
- Also available: Solenoid Valve (RPI Part #CMV257)

Fits: Dryer Assembly

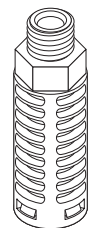

RPI Part #CMM237
OEM Part #'s - See
Chart Above

PURGE MUFFLER

- Size: 13/16" OD x 2-7/16" lg with 11/16" hex
- Port Size: 1/4" MPT
- Material: Polyvinyl foam

Fits: Dryer Assembly

RPI Part #CMV259
OEM Part #'s - See
Chart Above

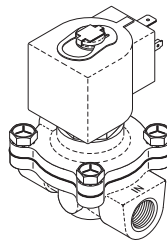

SOLENOID VALVE

- 24VDC 50/60 Hz., 11.5W (50 Ohms)
- Ports: 3/8" FPT; 2-Way; N.C.
- **Note:** There are 2 solenoid valves per unit
- Also available: Solenoid Valve Repair Kit (RPI Part #CMK260), Purge Muffler (RPI Part #CMM238); and Wire Connector (RPI Part #TUC084)

Fits: Dryer Assembly

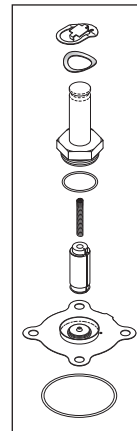

RPI Part #CMK260
OEM Part #'s - See
Chart Above

SOLENOID VALVE REPAIR KIT

- Includes all parts as shown
- **Note:** There are 2 solenoid valves per unit
- Also available: Solenoid Valve (RPI Part #CMV259)

Fits: Dryer Assembly

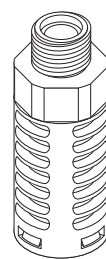

RPI Part #CMM238
OEM Part #'s - See
Chart Above

PURGE MUFFLER

- Size: 1" OD x 2 5/8" lg with 1" hex
- Port Size: 3/8" NPT
- Material: Polyvinyl foam

Fits: Dryer Assembly

SOLENOID VALVES & REPAIR KITS (continued)

RPI PART #	DESCRIPTION	AIR TECHNIQUES	APOLLO/MIDMARK®	DENTALEZ®/CUSTOM AIR/RAMVAC	MATRIX/MIDMARK®	MIDMARK®	TECH WEST
CMK133	SOLENOID VALVE REPAIR KIT	85423					
CMK136	SOLENOID VALVE REPAIR KIT		No OEM Part # Available		No OEM Part # Available	No OEM Part # Available	
CMK139	SOLENOID VALVE REPAIR KIT						No OEM Part # Available
CMV132	SOLENOID VALVE (PURGE)	85179, 85377-1, 85423 & 85946					
CMV134	SOLENOID VALVE (PURGE)	85377-2, 85378, 85379 & 85424					
CMV135	SOLENOID VALVE (PURGE)		PVV70501 & ACA85332		77001324 & 77001571	002-1390-00 & 002-1391-00	
CMV137	SOLENOID VALVE (PURGE)		PVV70502 & ACA85332		77001325, 77001570 & 77001572	002-1383-00, 002-1384-00, 002-1385-00, 002-1386-00, 002-1387-00, 002-1388-00 & 002-1389-00	
CMV138	SOLENOID VALVE (PURGE)						DSV-115
CMV140	SOLENOID VALVE (PURGE)						DSV-230

RPI Part #CMV132
OEM Part #'s - See Chart Above
SOLENOID VALVE (PURGE)
 • 120VAC, 60 Hz., 9.5 W, FWR
 • Ports: 1/4" FPT; 2-way; N.O.
 • Includes: Solenoid valve, 2 ft. flex conduit with fittings, and 48" wires with terminals
 • Also available: Solenoid Valve Repair Kit (RPI Part #CMK133) and Adaptor (RPI Part #RPF833)
Fits: Purge Assembly

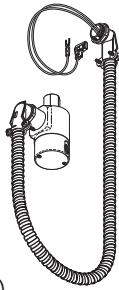

RPI Part #CMV134
OEM Part #'s - See Chart Above
SOLENOID VALVE (PURGE)
 • 230VAC, 60 Hz., 9.5 W, FWR
 • Ports: 1/4" FPT; 2-way; N.O.
 • Includes: Solenoid valve, 2 ft. flex conduit with fittings, and 48" wires with terminals
 • Also available: Solenoid Valve Repair Kit (RPI Part #CMK133) and Adaptor (RPI Part #RPF833)
Fits: Purge Assembly

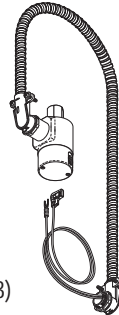

RPI Part #CMK133
OEM Part #'s - See Chart Above
SOLENOID VALVE REPAIR KIT
 • Piston style repair kit
 • Includes all parts as shown
 • Also available: Solenoid Valve (Purge) (RPI Part #'s CMV132 & CMV134), Double Ended Spanner Wrench (RPI Part # RPT501), Spanner Nut (RPI Part #ILS014), and High Temp Lubricant (RPI Part #RPL090)
Fits: Solenoid Valve (Purge)

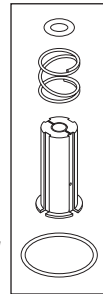

RPI Part #CMV135
OEM Part #'s - See Chart Above
SOLENOID VALVE (PURGE)
 • 120VAC, 50/60 Hz., 8W (156 Ohms)
 • Ports: 1/4" FPT; N.O.
 • Includes: Solenoid valve, 24" wires and (3) #10 ring terminal
 • Also available: Solenoid Valve Repair Kit (RPI Part #CMK136), Exhaust Silencer (RPI Part #CMS128), and Adaptor (RPI Part #RPF833)
Fits: Purge Assembly

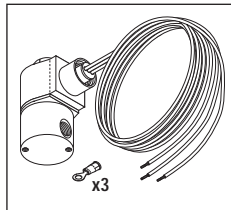

RPI Part #CMV137
OEM Part #'s - See Chart Above
SOLENOID VALVE (PURGE)
 • 208VAC, 60 Hz., 8W (503 Ohms)
 • Ports: 1/4" FPT; N.O.
 • Includes: Solenoid valve, 24" wires and (3) #10 ring terminal
 • Also available: Solenoid Valve Repair Kit (RPI Part #CMK136), Exhaust Silencer (RPI Part #CMS128), and Adaptor (RPI Part #RPF833)
Fits: Purge Assembly

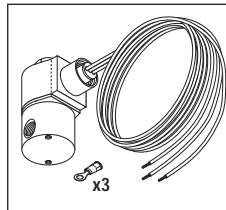

RPI Part #CMK136
OEM Part #'s - See Chart Above
SOLENOID VALVE REPAIR KIT
 • Piston style repair kit
 • Includes all parts as shown
 • Also available: Solenoid Valve (Purge) (RPI Part #'s CMV135 & CMV137)
Fits: Purge Solenoid Valve

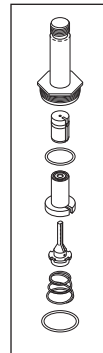

RPI Part #CMV138
OEM Part #'s - See Chart Above
SOLENOID VALVE (PURGE)
 • 120VAC, 50/60 Hz., 8W (115 Ohms)
 • Ports: 1/4" FPT; N.O.
 • Includes: Solenoid valve, 24" wires and (3) #10 ring terminal
 • Also available: Solenoid Valve Repair Kit (RPI Part #CMK136), Exhaust Silencer (RPI Part #CMS128), and Adaptor (RPI Part #RPF833)
Fits: Purge Assembly

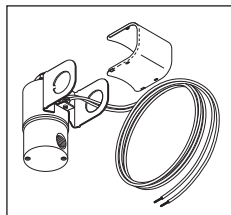

RPI Part #CMV140
OEM Part #'s - See Chart Above
SOLENOID VALVE (PURGE)
 • 120VAC, 50/60 Hz., 11W (467 Ohms)
 • Ports: 1/4" FPT; N.O.
 • Includes: Solenoid valve and 24" wires with conduit knock out for left or right wire exit
 • Also available: Solenoid Valve Repair Kit (RPI Part #CMK139) and Adaptor (RPI Part #RPF833)
Fits: Purge Assembly

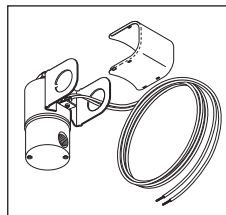

RPI Part #CMK139
OEM Part #'s - See Chart Above
SOLENOID VALVE REPAIR KIT
 • Includes all parts as shown
 • Also available: Solenoid Valve (Purge) (RPI Part #'s CMV138 & CMV140)
Fits: Purge Solenoid Valve

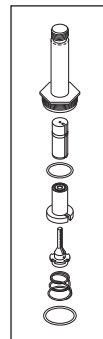

Air Techniques, Apollo/Midmark®, MDT McKesson, DentalEZ®/Custom Air/RamVac, Jun-Air, Matrix/Midmark®, Midmark®, Pelton & Crane, and Tech West/Turbine Ind.

START BOXES

RPI PART #	DESCRIPTION	AIR TECHNIQUES	APOLLO/MIDMARK®	DENTALEZ®/CUSTOM AIR/RAMVAC	MATRIX/MIDMARK®	MIDMARK®	TECH WEST
CMA029	START BOX (1HP, 208/230V)	66515	SPD95291		77001346	77001346	CRA-208
CMA033	START BOX (1HP, 230V)	66500	SPD95290	645011011	77001344		CRA-230
CMA035	START BOX (1HP, 115V)	62500	SPD95280	645011010	77001345		CRA-115
CMA039	START BOX (3/4HP, 208/230V)	64515	SPD95285 SPD95286				
CMA041	START BOX (3/4HP, 115V)	60500	SPD95275				

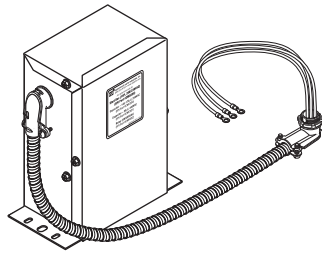

RPI Part #CMA029
OEM Part #'s - See Chart Above

START BOX (1HP, 208/230V)

- Size: 7.38" L x 4.71" W x 3.21" D
- Material: 20 ga. Galvanized Steel
- Start Box for 1HP 208/230VAC Compressor Heads
- Includes: Start Capacitor (RPI Part #CMC030), Run Capacitor (RPI Part #CMC031) and Relay (RPI Part #CMR032)

Fits: Compressor

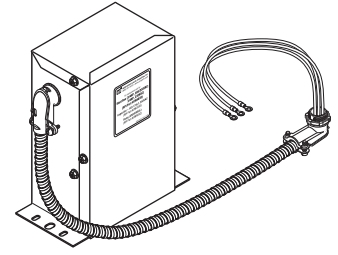

RPI Part #CMA039
OEM Part #'s - See Chart Above

START BOX (3/4HP, 208/230V)

- Size: 7.38" L x 4.71" W x 3.21" D
- Material: 20 ga. Galvanized Steel
- Start Box for 3/4HP 208/230VAC or 3/4HP 230VAC Compressor Heads
- Includes: Start Capacitor (RPI Part #CMC030) and Relay (RPI Part #CMR032)

Fits: Compressor

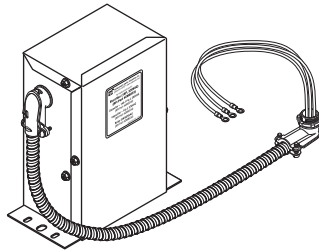

RPI Part #CMA033
OEM Part #'s - See Chart Above

START BOX (1HP, 230V)

- Size: 7.38" L x 4.71" W x 3.21" D
- Material: 20 ga. Galvanized Steel
- Start Box for 1HP 230VAC Compressor Heads
- Includes: Start Capacitor (RPI Part #CMC030), Run Capacitor (RPI Part #CMC031) and Relay (RPI Part #CMR032)

Fits: Compressor

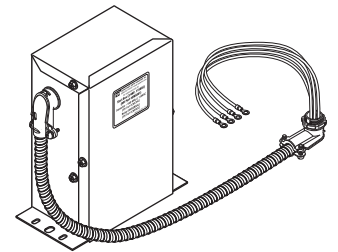

RPI Part #CMA041
OEM Part #'s - See Chart Above

START BOX (3/4HP, 115V)

- Size: 7.38" L x 4.71" W x 3.21" D
- Material: 20 ga. Galvanized Steel
- Start Box for 3/4HP 115VAC Compressor Heads
- Includes: Start Capacitor (RPI Part #CMC042) and Relay (RPI Part #CMR032)

Fits: Compressor

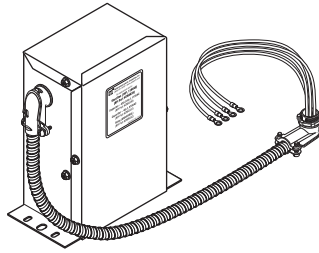

RPI Part #CMA035
OEM Part #'s - See Chart Above

START BOX (1HP, 115V)

- Size: 7.38" L x 4.71" W x 3.21" D
- Material: 20 ga. Galvanized Steel
- Start Box for 1HP 115VAC Compressor Heads
- Includes: Start Capacitor (RPI Part #CMC036), Run Capacitor (RPI Part #CMC037) and Relay (RPI Part #CMR032)

Fits: Compressor

SPECIFICATIONS

For Capacitors, see page 414
For Relays, see page 432

THERMAL PROTECTOR ASSEMBLIES

RPI PART #	DESCRIPTION	AIR TECHNIQUES	APOLLO/ MIDMARK®	DENTALEZ®/ CUSTOM AIR/RAMVAC	MATRIX/ MIDMARK®	MDT McKESSON	MIDMARK®	PELTON & CRANE	TECH WEST
CMP061	THERMAL PROTECTOR ASSEMBLY	66504	HCA30615	No OEM Part # Available	61894802	3-08-0229-10	61894802		KOPC-230
CMP062	THERMAL PROTECTOR ASSEMBLY	62504	HCA30610	No OEM Part # Available	61894801	3-08-0228-10	61894801		KOPC-115
CMP063	THERMAL PROTECTOR ASSEMBLY	64503	HCA30605			3-08-0231-10			
CMP064	THERMAL PROTECTOR ASSEMBLY	64503	HCA30600			3-08-0227-10			
CMP204	THERMAL PROTECTOR ASSEMBLY	No OEM Part # Available							
CMP206	THERMAL PROTECTOR ASSEMBLY	No OEM Part # Available							
CMP207	THERMAL PROTECTOR ASSEMBLY	No OEM Part # Available							
CMP244	THERMAL PROTECTOR ASSEMBLY	85273							
PCP641	THERMAL PROTECTOR ASSEMBLY							005110	

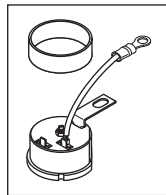

RPI Part #CMP061
OEM Part #'s -
See Chart Above

THERMAL PROTECTOR ASSEMBLY

- For use with 1HP 208-230VAC or 1HP 230VAC Compressor Heads
- Automatic reset; Includes: Protector clamp
- Opens at 135°C ± 5°C; Closes at 57°C ± 9°C
- 80A @ 120VAC; 60A @ 240VAC

Fits: Compressor Head Terminal Box

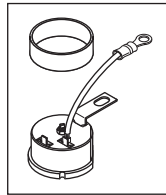

RPI Part #CMP062
OEM Part #'s -
See Chart Above

THERMAL PROTECTOR ASSEMBLY

- For use with 1HP 115VAC Compressor Heads
- Automatic reset; Includes: Protector clamp
- Opens at 120°C ± 5°C; Closes at 78°C ± 9°C
- 80A @ 120VAC; 60A @ 240VAC

Fits: Compressor Head Terminal Box

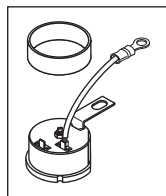

RPI Part #CMP063
OEM Part #'s -
See Chart Above

THERMAL PROTECTOR ASSEMBLY

- For use with 3/4HP 208-230VAC or 3/4HP 230VAC Compressor Heads
- Automatic reset; Includes: Protector clamp
- Opens at 105°C ± 5°C; Closes at 61°C ± 9°C
- 40A @ 120VAC; 30A @ 240VAC

Fits: Compressor Head Terminal Box

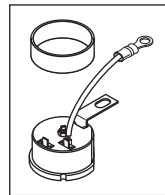

RPI Part #CMP064
OEM Part #'s -
See Chart Above

THERMAL PROTECTOR ASSEMBLY

- For use with 3/4HP 115VAC Compressor Heads
- Automatic reset; Includes: Protector clamp
- Opens at 120°C ± 5°C; Closes at 69°C ± 9°C
- 40A @ 120VAC; 30A @ 240VAC

Fits: Compressor Head Terminal Box

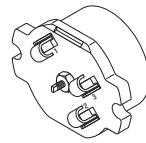

RPI Part #CMP204
OEM Part #'s -
See Chart Above

THERMAL PROTECTOR ASSEMBLY

- Automatic reset
- Opens at 150°C ± 5°C; Closes at 115°C ± 9°C
- 80A @ 120VAC; 60A @ 240VAC

Fits: Compressor Head Terminal Box

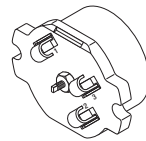

RPI Part #CMP206
OEM Part #'s -
See Chart Above

THERMAL PROTECTOR ASSEMBLY

- Automatic reset
- Opens at 135°C ± 5°C; Closes at 102°C ± 9°C
- 80A @ 120VAC; 60A @ 240VAC
- **Important Note:** For use on **single headed** AirStar® 40 compressors. (For dual headed AirStar® 40 compressors use Thermal Protector Assembly (RPI Part #CMP207))

Fits: Compressor Head Terminal Box

RPI Part #CMP207
OEM Part #'s -
See Chart Above

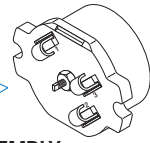

THERMAL PROTECTOR ASSEMBLY

- Automatic reset
- Opens at 135°C ± 5°C; Closes at 102°C ± 9°C
- 80A @ 120VAC; 60A @ 240VAC
- **Important Note:** For use on **dual headed** AirStar® 40 compressors. (For single headed AirStar® 40 compressors use Thermal Protector Assembly (RPI Part #CMP206))

Fits: Compressor Head Terminal Box

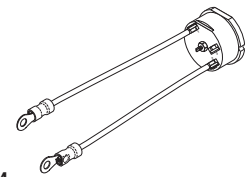

RPI Part #CMP244
OEM Part #'s - See Chart Above

THERMAL PROTECTOR ASSEMBLY

- Automatic reset
- Opens at 90°C ± 5°C; Closes at 57°C ± 9°C
- 80A @ 120VAC; 60A @ 240VAC
- 5" lg. wires with #10 ring terminals

Fits: Compressor Head Terminal Box

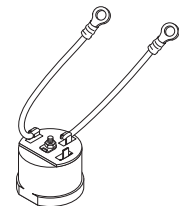

RPI Part #PCP641
OEM Part #'s -
See Chart Above

THERMAL PROTECTOR ASSEMBLY

- Automatic reset
- Opens at 120°C; Closes at 92°C
- 80A @ 120VAC; 60A @ 240VAC
- 5" lg. wires with #10 ring terminals

Fits: Compressor Head Terminal Box

Air Techniques, Apollo/Midmark®, MDT McKesson, DentalEZ®/Custom Air/RamVac, Jun-Air, Matrix/Midmark®, Midmark®, Pelton & Crane, and Tech West/Turbine Ind.

TOOLS - GREASE GUN & ACCESSORIES FOR SCROLL COMPRESSORS

RPI PART #	DESCRIPTION	APOLLO/ MIDMARK®	MIDMARK®
RXG070	GREASE CARTRIDGE	RSS40645	RSS40645
RXG071	GREASE GUN	HPA30530	HPA30530
RXK069	GREASE GUN KIT	HPA30530	HPA30530
RXN072	GREASE GUN NOZZLE	HPA30530	HPA30530

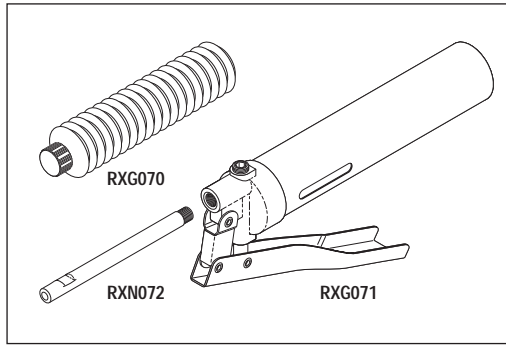

RPI Part #RXK069
OEM Part #'s - See Chart Above

GREASE GUN KIT

- OEM recommends regreasing of compressor head and motor bearings every 5,000 hours
- Includes: Grease Gun (RPI Part #RXG071), Grease Gun Nozzle (RPI Part #RXN072), and Grease Cartridge (RPI Part #RXG070)
- Used to grease the bearings in the scroll compressor head when replacing the Tip Seal Kit (RPI Part #CMK287) and/or Compressor PM & Tip Seal Kit (RPI Part #CMK286)

Fits: Scroll Compressor Head



RPI Part #RXG070
OEM Part #'s - See Chart Above

GREASE CARTRIDGE

- 2.8 oz. (80 g) cartridge
- Also included in Tip Seal Kit (RPI Part #CMK287) and/or Compressor PM & Tip Seal Kit (RPI Part #CMK286)



RPI Part #RXG071
OEM Part #'s - See Chart Above

GREASE GUN



RPI Part #RXN072
OEM Part #'s - See Chart Above

GREASE GUN NOZZLE

SERVICE TIP: Regrease the compressor head and motor bearings every 5,000 hours!

- The RPI Grease Gun Kit (RPI Part #RXK069) is the perfect tool to grease the OS (Orbital Scroll) side matched angular ball bearings and the internal crankshaft roller bearing on scroll compressor heads. Be sure to lubricate all four grease nipples (zerk fittings) as shown below, three places on the OS (Orbital Scroll) side and one located in the sight hole on the plastic dust proof cap.
- Used to grease the bearings in the scroll compressor head when replacing the Tip Seal Kit (RPI Part #CMK287) and/or Compressor PM & Tip Seal Kit (RPI Part #CMK286)

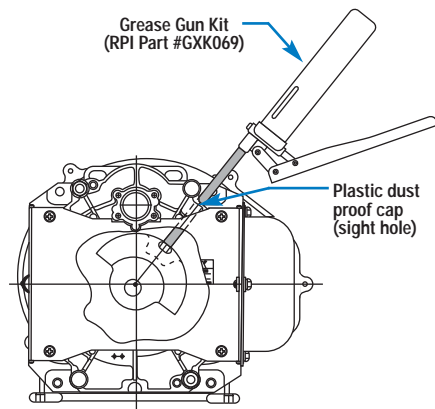
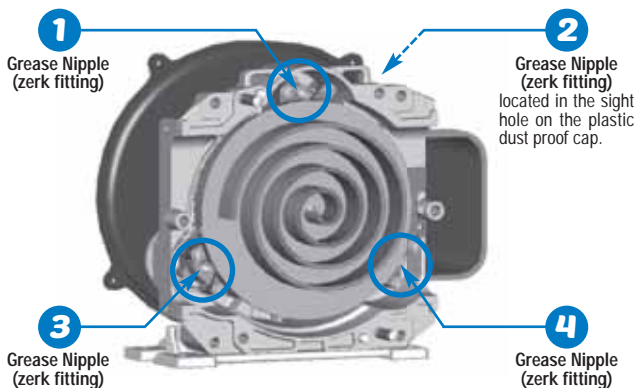

TUBING & ACCESSORIES

RPI PART #	DESCRIPTION	AIR TECHNIQUES	APOLLO/MIDMARK®	JUN-AIR	MATRX/MIDMARK®	MIDMARK®	TECH WEST
CMT221	TUBING (10mm OD BLACK)	86726					
CMT222	TUBING (12mm OD BLACK)	86727					
RPT276	TUBING (1/4" OD CLEAR POLY)		No OEM Part # Available		No OEM Part # Available	No OEM Part # Available	No OEM Part # Available
RPT380	TUBING (.170" ID x 1/4" OD NATURAL)	89948					
RPT441	PVC TUBING - CLEAR		Included in 86727				
RPT604	TUBING (1/4" ID CLEAR PVC)		No OEM Part # Available		No OEM Part # Available	No OEM Part # Available	No OEM Part # Available
RPT670	TUBING (4mm ID x 6mm OD BLACK)			No OEM Part # Available			
RPT849	TUBING (5/16" ID x 7/16" OD CLEAR) <i>Not shown on this page - see Page 430</i>		No OEM Part # Available		No OEM Part # Available	No OEM Part # Available	No OEM Part # Available
RPT940	TUBING (1/16" ID x 1/8" OD CLEAR)	No OEM Part # Available					
RXT017	TUBING (6.5mm ID x 10mm OD BLACK)	86726					
RXT018	TUBING (8mm ID x 12mm OD BLACK)	86727					
RXT019	TUBING (.275" ID x 3/8" OD NATURAL)	89955					

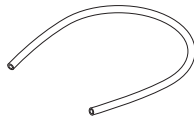

RPI Part #CMT221
OEM Part #'s - See Chart Above

TUBING (10mm OD BLACK)
 • Material: Flame retardant and weld spatter resistant polyurethane (Equiv. to Flamex®)
 • Size: 20" lg.
 • Tubing is also sold by the foot (RPI Part #RXT017)
Fits: Cooler Assembly to Membrane Dryer, 10mm Push-In Fittings

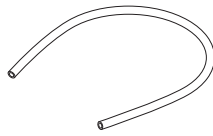

RPI Part #CMT222
OEM Part #'s - See Chart Above

TUBING (12mm OD BLACK)
 • Material: Flame retardant and weld spatter resistant polyurethane (Equiv. to Flamex®)
 • Size: 28" lg.
 • Tubing is also sold by the foot (RPI Part #RXT018)
Fits: Membrane Dryer to Tank, 12mm Push-In Fittings

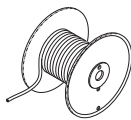

RPI Part #RPT276
OEM Part #'s - See Chart Above

TUBING (5/32" ID x 1/4" OD CLEAR)
 • Sold by the foot (reel not included)
 • Material: Polyurethane
 • Included in: Collection Container Kit (RPI Part #CMK181) and Syringe Pump/Extractor (RPI Part #RPT842)
Fits: 5/32" Barbs or 1/4" Push-In Fittings

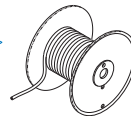

RPI Part #RPT380
OEM Part #'s - See Chart Above

TUBING (.170" ID x 1/4" OD NATURAL)
 • Sold by the foot (reel not included)
 • Material: Nylon®
Fits: 1/4" Push-In Fittings

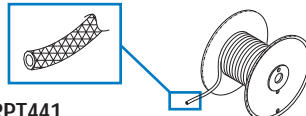

RPI Part #RPT441
OEM Part #'s - See Chart Above

TUBING (.50" ID x .73" OD CLEAR/BRAIDED)
 • Sold by the foot (reel not included)
 • Replacement tubing included in Fresh Air Intake Filter Kit (RPI Part #CMK003)
Fits: 1/2" Barbs

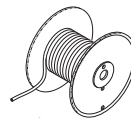

RPI Part #RPT604
OEM Part #'s - See Chart Above

TUBING (1/4" ID x 3/8" OD CLEAR)
 • Sold by the foot (reel not included)
 • Material: Clear flexible PVC
 • Included in: Collection Container Kit (RPI Part #'s CMK180 & CMK181)
Fits: 1/4" Barbs or 3/8" Push-In Fittings

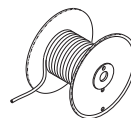

RPI Part #RPT670
OEM Part #'s - See Chart Above

TUBING (4mm ID x 6mm OD BLACK)
 • Sold by the foot (reel not included)
 • Polyurethane tubing - black
 • Included in: Pressure Switch (RPI Part #CMS055)
Fits: 4mm Barbs or 6mm Push-In Fittings

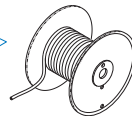

RPI Part #RPT940
OEM Part #'s - See Chart Above

TUBING (1/16" ID x 1/8" OD CLEAR)
 • Sold by the foot (reel not included)
 • Material: Polyurethane
 • Included in: Orifice Assemblies (RPI Part #'s CMA245, CMA246, CMA252 & CMA253)
Fits: 1/16" Barbs

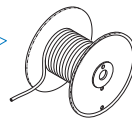

RPI Part #RXT017
OEM Part #'s - See Chart Above

TUBING (6.5mm ID x 10mm OD BLACK)
 • Sold by the foot (reel not included)
 • Material: Flame retardant and weld spatter resistant polyurethane (Equiv. to Flamex®)
Fits: 10mm Push-In Fittings

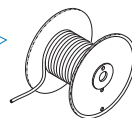

RPI Part #RXT018
OEM Part #'s - See Chart Above

TUBING (8mm ID x 12mm OD BLACK)
 • Sold by the foot (reel not included)
 • Material: Flame retardant and weld spatter resistant polyurethane (Equiv. to Flamex®)
Fits: 12mm Push-In Fittings

RPI Part #RXT019
OEM Part #'s - See Chart Above

TUBING (.275" ID x 3/8" OD NATURAL)
 • Sold by the foot (reel not included)
 • Material: Nylon®
 • Included in: Check Valve Upgrade Kit (RPI Part #'s CMK247, CMK248 & CMK249)
Fits: 3/8" Push-In Fittings

Air Techniques, Apollo/Midmark®, MDT McKesson, DentalEZ®/Custom Air/RamVac, Jun-Air, Matrix/Midmark®, Midmark®, Pelton & Crane, and Tech West/Turbine Ind.

UNLOADER VALVES

RPI PART #	DESCRIPTION	AIR TECHNIQUES	APOLLO/MIDMARK®	JUN-AIR	MDT McKESSON
CMV121	UNLOADER VALVE Also available: Unloader Valve Repair Kit (RPI Part #CMK122)	60030	ACA85966		
CMK122	UNLOADER VALVE REPAIR KIT Also available: Unloader Valve (RPI Part #CMV121)	No OEM Part # Available	No OEM Part # Available		
RPF826	ADAPTOR (3/8 FPT x 1/2 MPT) - 2/pkg Included in: Unloader Valve (RPI Part #CMV121)	No OEM Part # Available	No OEM Part # Available		
RPF827	MALE CONNECTOR - 2/pkg Included in: Unloader Valve (RPI Part #CMV121)	No OEM Part # Available	No OEM Part # Available		
RPF828	ADAPTOR (1/4 MPT x 3/8 MPT) - 2/pkg Included in: Unloader Valve (RPI Part #CMV121)	No OEM Part # Available	No OEM Part # Available		
CMV123	UNLOADER VALVE Also available: Unloader Valve Repair Kit (RPI Part #CMK124)				3-08-0308-10
CMK124	UNLOADER VALVE REPAIR KIT Also available: Unloader Valve (RPI Part #CMV123)				No OEM Part # Available
RPF662	MALE CONNECTOR Included in: Unloader Valve (RPI Part #CMV123)				No OEM Part # Available
CMV058	UNLOADER VALVE Also available: Pressure Switch (RPI Part #CMS055)			JA6973300	

RPI Part #CMV121
OEM Part #'s - See Chart Above

UNLOADER VALVE

- Quick exhaust valve with (2) 1/4" FPT ports and (1) 3/8" FPT exhaust port
- Material: Aluminum body and Buna N diaphragm
- Includes all parts as shown
- Also available: Unloader Valve Repair Kit (RPI Part CMK122), 1/4" Teflon Thread Sealing Tape (RPI Part #RPT579), and Copper Tubing (RPI Part #RPT547)

Fits: Desiccant Tank

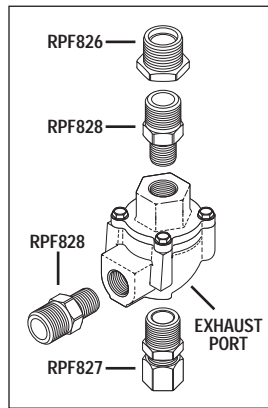

RPI Part #CMK122
OEM Part #'s - See Chart Above

UNLOADER VALVE REPAIR KIT

- Includes: Valve seal, O-ring, and mounting screws

Fits: Unloader Valve (RPI Part #CMV121) only

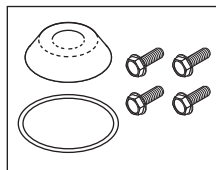

RPI Part #RPF826
OEM Part #'s - See Chart Above

ADAPTOR (3/8" FPT x 1/2" MPT)

- 2 per package
- Material: Brass
- Included in: Unloader Valve (RPI Part #CMV121)

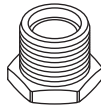

RPI Part #RPF827
OEM Part #'s - See Chart Above

MALE CONNECTOR (3/8" TUBE x 3/8" MPT)

- 2 per package
- Material: Brass
- Included in: Unloader Valve (RPI Part #CMV121)



RPI Part #RPF828
OEM Part #'s - See Chart Above

ADAPTOR (1/4" MPT x 3/8" MPT)

- 2 per package
- Material: Brass
- Included in: Unloader Valve (RPI Part #CMV121)

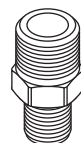

RPI Part #CMV123
OEM Part #'s - See Chart Above

UNLOADER VALVE

- Quick exhaust valve with (3) 1/4" FPT ports
- Material: Aluminum body
- Includes all parts as shown
- Also available: Unloader Valve Repair Kit (RPI Part #CMK124), 1/4" Teflon Thread Sealing Tape (RPI Part #RPT579), and Copper Tubing (RPI Part #RPT547)

Fits: Desiccant Tanks (MDT McKesson Part #3-08-0729-20 & 3-08-0800-30)

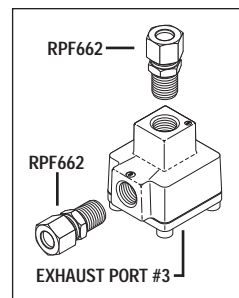

RPI Part #CMK124
OEM Part #'s - See Chart Above

UNLOADER VALVE REPAIR KIT

- Includes: Valve disk, and O-ring
- Also available: Unloader Valve (RPI Part #CMV123)

Fits: Unloader Valve

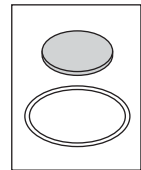

RPI Part #RPF662
OEM Part #'s - See Chart Above

MALE CONNECTOR (3/8" TUBE x 1/4" MPT)

- Material: Brass
- Includes: Compression Nut (RPI Part #RPF222) and Compression Sleeve (RPI Part #RPF218)
- Included in: Collection Container Kit (RPI Part #CMK180), and Unloader Valve (RPI Part #CMV123)

Fits: Collection Container Kit, and Unloader Valve



RPI Part #CMV058
OEM Part #'s - See Chart Above

UNLOADER VALVE

- Plastic body; 1/8" BSP
- 4mm barb fitting
- Included in: Pressure Switch (RPI Part #CMS055)

Fits: Pressure Switch

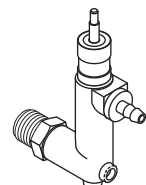

Models: DV5, DV7, DV10, DV12, SC3, SC5, SC7, SC10, & SC12

New PM Kits to fit

**A-dec®/Dean®
Dental Compressors
and Dental Vacuum Units!**

PM Kits to fit A-dec/Dean Dental Compressors

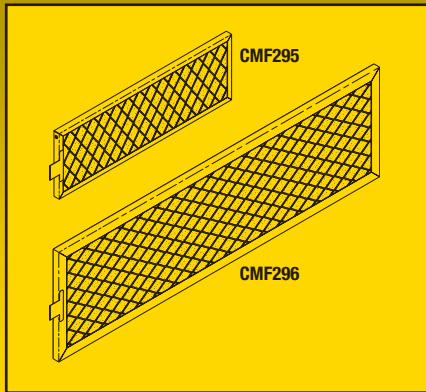

RPI Part #CMK293
OEM Part #A0050

COMPRESSOR PM KIT

- For Oil-less dual, triple and quad headed compressors
- All parts also sold separately
- Includes all parts as shown plus a PM Sticker and PM checklist
- See *the RPI Advantage* below

Fits: Compressor Body
Models: SC3, SC5 & SC7

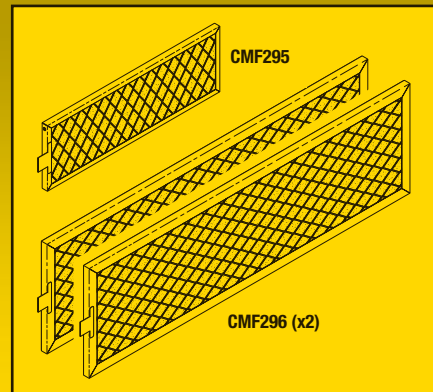

RPI Part #CMK294
OEM Part #A0150

COMPRESSOR PM KIT

- For Oil-less 5 and 6 headed compressors
- All parts also sold separately
- Includes all parts as shown plus a PM Sticker and PM checklist
- See *the RPI Advantage* below

Fits: Compressor Body
Models: SC10 & SC12

PM Kit to fit A-dec/Dean Dental Vacuum Units



RPI Part #VPK183
OEM Part #A0049

VACUUM PM KIT

- **Service Tip:** Air filter life depends on vacuum usage, nature of environment, and amount of aspirated material. Inspect air filter every 1,000 hours and replace every 2,000 hours or when visibly dirty.
- All parts also sold separately
- Includes all parts as shown plus a PM Sticker and PM checklist
- See *the RPI Advantage* below

Fits: Inside Separator Tank and Drain Assembly
Models: DV5, DV7, DV10 & DV12

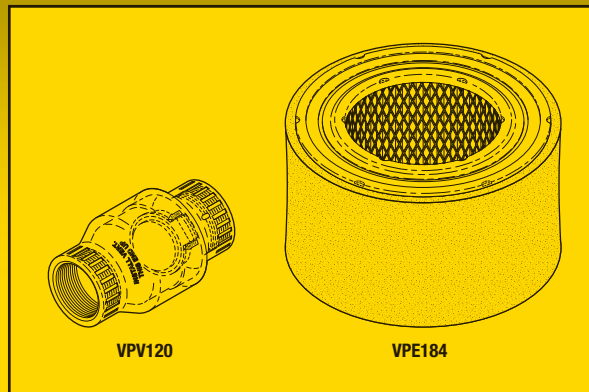

RPI Filters and PM Kits include a PM Sticker that can be attached to the compressor or vacuum unit for recording the date that the filters were replaced. It's the RPI Advantage!



replacement parts industries, inc.

CALL (800) 221-9723 • FAX (818) 882-7028 • EMAIL order@riparts.com • WEBSITE www.riparts.com

The above parts are manufactured by Replacement Parts Industries, Inc. to fit the equipment noted. All product names used in this document are trademarks or registered trademarks of their respective holders. 2010AD Show 02/21

Air Filters to fit A-dec/Dean Dental Compressors!

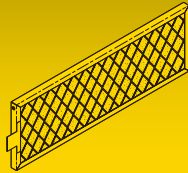

RPI Part #CMF295

OEM Part # (OEM Part # Not Available)

AIR FILTER

- Size: 9.87" lg. x 3.25" wide
- Material: 60 PPI Quadrafoam, color black, aluminum frame and stainless steel mesh
- Included in: Compressor PM Kit (RPI Part #CMK293) and Compressor PM Kit (RPI Part #CMK294)
- See *the RPI Advantage* on reverse side

Fits: Compressor Body

Models: SC3, SC5, SC7, SC10 & SC12

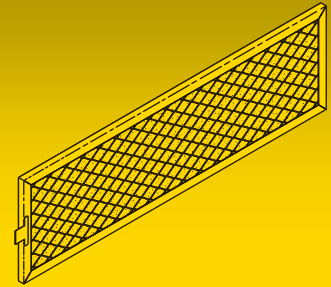

RPI Part #CMF296

OEM Part # (OEM Part # Not Available)

AIR FILTER

- Size: 18.44" lg. x 5.44" wide
- Material: 25 PPI Quadrafoam, color green, aluminum frame and stainless steel mesh
- Included in: Compressor PM Kit (RPI Part #CMK293) and Compressor PM Kit (RPI Part #CMK294)
- See *the RPI Advantage* on reverse side

Fits: Compressor Body

Models: SC3, SC5, SC7, SC10 & SC12

New Parts to fit A-dec/Dean Dental Compressors & Vacuums!

ADDRESS SERVICES REQUESTED

PERMIT NO. 2399
VAN NUYS, CA
U.S. POSTAGE PAID
PRESORTED STANDARD

625 Cochran Street • Simi Valley, California • 93065
replacement parts industries, inc.



Parts to fit A-dec/Dean Dental Vacuum Units!

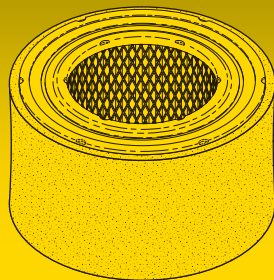

RPI Part #VPE184

OEM Part # (OEM Part # Not Available)

FILTER ELEMENT

- 5 micron
- Size 7.88" OD x 4.81" lg.
- Included in: Vacuum PM Kit (RPI Part #VPK183)
- See *the RPI Advantage* on reverse side

Fits: Inside Separator Tank

Models: DV5, DV7, DV10 & DV12

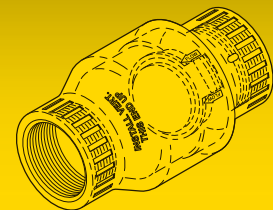

RPI Part #VPV120

OEM Part # (OEM Part # Not Available)

CHECK VALVE (1-1/2")

- Ports: 1-1/2" FPT
- Material: Clear PVC
- Size: 3.38" dia. x 5.75" lg.
- Included in: Vacuum PM Kit (RPI Part #VPK183)

Fits: Inside Separator Tank and Drain Assembly

Models: DV5, DV7, DV10 & DV12

500 SERIES HANDPIECE CONTROL BLOCK (OEM Part #38.1776.00) Exploded View

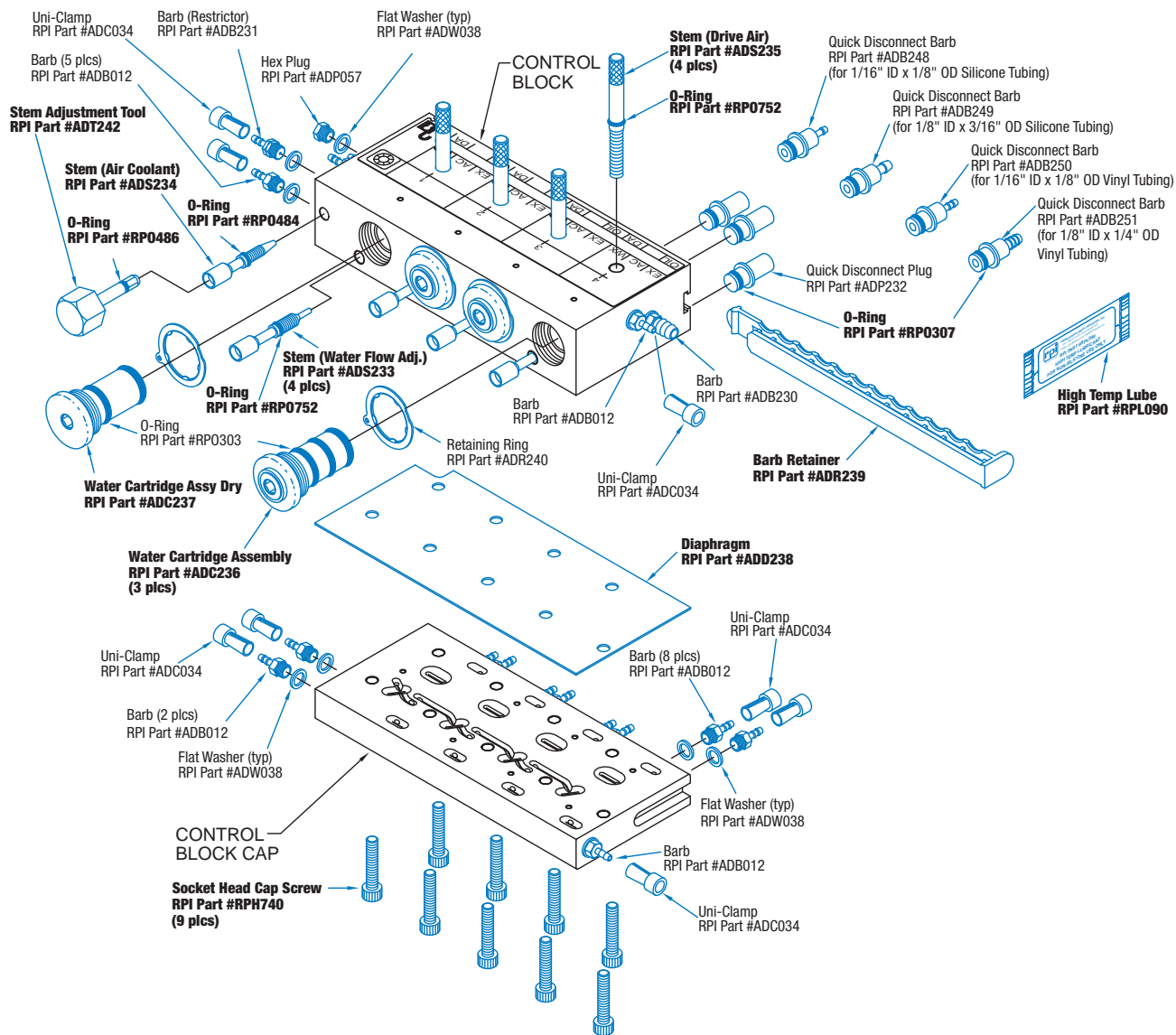

CONTROL BLOCK KIT (MINOR) RPI Part #ADK257

(Kit parts identified in bold text - All parts also sold separately)

For simple repairs to the Control Block – like air and water leaks – this unique Kit includes repair parts such as cartridge assemblies, diaphragm, stems, and o-rings. Right at your fingertips!

**FOR DETAILS ABOUT THIS KIT,
SEE PAGE 501**



CONTROL BLOCK KIT (MAJOR) RPI Part #ADK241

(Kit includes all parts shown in blue - All parts also sold separately)

With this Kit, you can easily replace any of the Control Block parts, or completely rebuild the Control Block. Save money and time with this Kit!

**FOR DETAILS ABOUT THIS KIT,
SEE PAGE 502**

Dental Equipment

Handpiece Control Block 300 Series (OEM Part #38.1831.00) & 500 Series (OEM Part #38.1776.00) (continued)



RPI Part #ADK257
OEM Part #38.1776.00 (Block Assy.)

CONTROL BLOCK KIT (MINOR)

- Kit includes Storage Case (RPI Part #RPC753)
- All parts also sold separately in quantities indicated below

Models: Handpiece Control Block 300 Series* (OEM Part #38.1831.00) & 500 Series (OEM Part #38.1776.00)

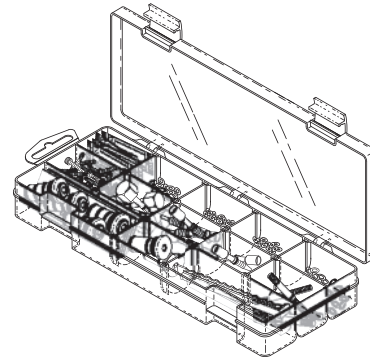

For simple repairs to the Control Block – like air and water leaks – this unique Kit includes repair parts such as cartridge assemblies, diaphragm, stems, and o-rings. Right at your fingertips!



ADC236

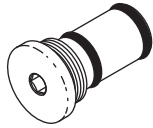

ADC237

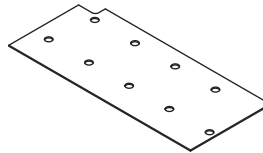

ADD238

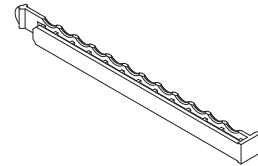

ADR239

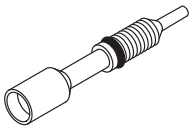

ADS233

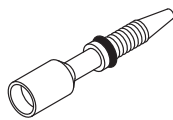

ADS234

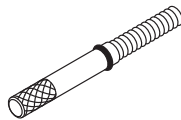

ADS235

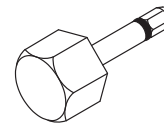

ADT242

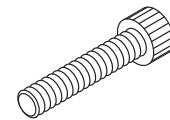

RPH740

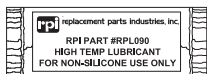

RPL090



RPO307
Shown
Actual Size



RPO484
Shown
Actual Size



RPO486
Shown
Actual Size



RPO752
Shown
Actual Size

RPI PART #	OEM PART #	DESCRIPTION	KIT QTY	REORDER QTY (PER PKG)	Fits Control Block 300 SERIES (OEM #38.1831.00)	Fits Control Block 500 SERIES (OEM #38.1776.00)
▶ ADC236	38.1780.00	WATER CARTRIDGE ASSEMBLY	4	1	•	•
▶ ADC237	38.1783.00	WATER CARTRIDGE ASSY DRY	2	1	•	•
▶ ADD238	38.1787.01	DIAPHRAGM	5	5		•
▶ ADR239	38.1800.00	BARB RETAINER	2	1		•
▶ ADS233	38.0516.00	STEM (WATER FLOW ADJ.)	4	1		•
▶ ADS234	38.0526.00	STEM (AIR COOLANT)	2	1		•
▶ ADS235	38.1785.01	STEM (DRIVE AIR)	4	1	•	•
▶ ADT242	38.1808.01 & 98.0867.02	STEM ADJUSTMENT TOOL	5	5		•
▶ RPH740	001.240.00	SOCKET HEAD CAP SCREW	25	25	•	•
▶ RPL090	98.0090.01	HIGH TEMP LUBRICANT	5	5	•	•
▶ RPO307	030.006.02	O-RING	12	12	•	•
▶ RPO484	030.003.01	O-RING	12	12	•	•
▶ RPO486	034.002.01	O-RING	12	12		•
▶ RPO752	035.034.01	O-RING	12	12	•	•

* All parts in this kit fit the Control Block 300 series (OEM Part #38.1831.00) with the exception of the following parts: Diaphragm (RPI Part #ADD238), Barb Retainer (RPI Part #ADR239), Stem (Water Flow Adj.) (RPI Part #ADS233), Stem (Air Coolant) (RPI Part #ADS234), Stem Adjustment Tool (RPI Part #ADT242), and O-Ring (RPI Part #RPO486).



RPI Part #ADK241
OEM Part #38.1776.00 (Block Assy.)

CONTROL BLOCK KIT (MAJOR)

- Kit includes Storage Case (RPI Part #RPC751)
 - All parts also sold separately in quantities indicated below
- Models:** Handpiece Control Block 300 Series* (OEM Part #38.1831.00) & 500 Series (OEM Part #38.1776.00)

With this Kit, you can easily replace any of the Control Block parts, or completely rebuild the Control Block. Save money and time with this Kit!

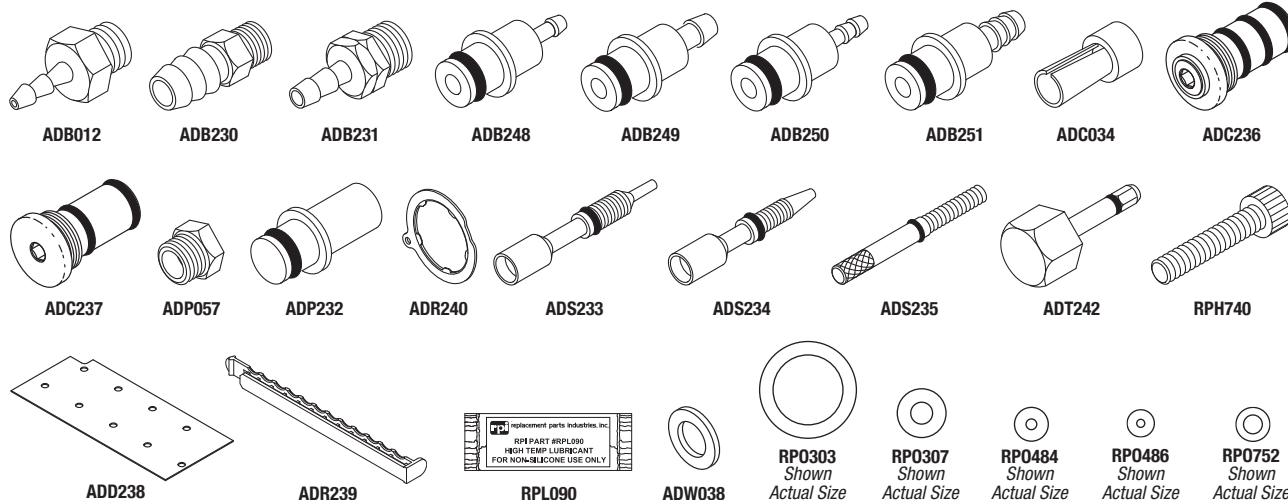
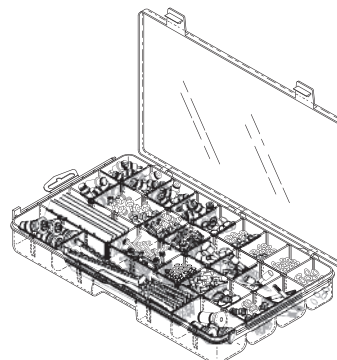

RPI PART #	OEM PART #	DESCRIPTION	KIT QTY	REORDER QTY (PER PKG)	Fits Control Block 300 SERIES (OEM #38.1831.00)	Fits Control Block 500 SERIES (OEM #38.1776.00)
ADB012	023-004-01 & 023.004.03	BARB	10	10	•	•
ADB230	023.505.01	BARB	10	10	•	•
ADB231	023.811.00	BARB (RESTRICTOR)	10	10	•	•
ADB248	026.174.01	QUICK DISCONNECT BARB 1/8" SILICONE	5	5	•	•
ADB249	026.175.01	QUICK DISCONNECT BARB 3/16" SILICONE	5	5	•	•
ADB250	026.161.00	QUICK DISCONNECT BARB 1/8" VINYL	5	5	•	•
ADB251	026.088.00	QUICK DISCONNECT BARB 1/4" VINYL	5	5	•	•
ADC034	025.007.01	UNI-CLAMP	20	20	•	•
ADC236	38.1780.00	WATER CARTRIDGE ASSEMBLY	4	1	•	•
ADC237	38.1783.00	WATER CARTRIDGE ASSY DRY	3	1	•	•
ADD238	38.1787.01	DIAPHRAGM	5	5	•	•
ADP057	021.016.01 & 021.016.00	HEX PLUG	10	10	•	•
ADP232	026.160.01	QUICK DISCONNECT PLUG	5	5	•	•
ADR239	38.1800.00	BARB RETAINER	3	1	•	•
ADR240	38.1779.01	RETAINING RING	5	5	•	•
ADS233	38.0516.00	STEM (WATER FLOW ADJ.)	4	1	•	•
ADS234	38.0526.00	STEM (AIR COOLANT)	2	1	•	•
ADS235	38.1785.01	STEM (DRIVE AIR)	4	1	•	•
ADT242	38.1808.01 & 98.0867.02	STEM ADJUSTMENT TOOL	5	5	•	•
ADW038	004-005-00	FLAT WASHER	50	50	•	•
RPH740	001.240.00	SOCKET HEAD CAP SCREW	25	25	•	•
RPL090	98.0090.01	HIGH TEMP LUBRICANT	5	5	•	•
RPO303	030.012.01	O-RING	12	12	•	•
RPO307	030.006.02	O-RING	12	12	•	•
RPO484	030.003.01	O-RING	12	12	•	•
RPO486	034.002.01	O-RING	12	12	•	•
RPO752	035.034.01	O-RING	12	12	•	•

* All parts in this kit fit the Control Block 300 series (OEM Part #38.1831.00) with the exception of the following parts: Diaphragm (RPI Part #ADD238), Barb Retainer (RPI Part #ADR239), Stem (Water Flow Adj.) (RPI Part #ADS233), Stem (Air Coolant) (RPI Part #ADS234), Stem Adjustment Tool (RPI Part #ADT242), and O-Ring (RPI Part #RPO486).

Dental Equipment

Handpiece Control Block Century Plus (OEM Part #38.0540.00)

CENTURY PLUS HANDPIECE CONTROL BLOCK (OEM Part #38.0540.00)

Exploded View

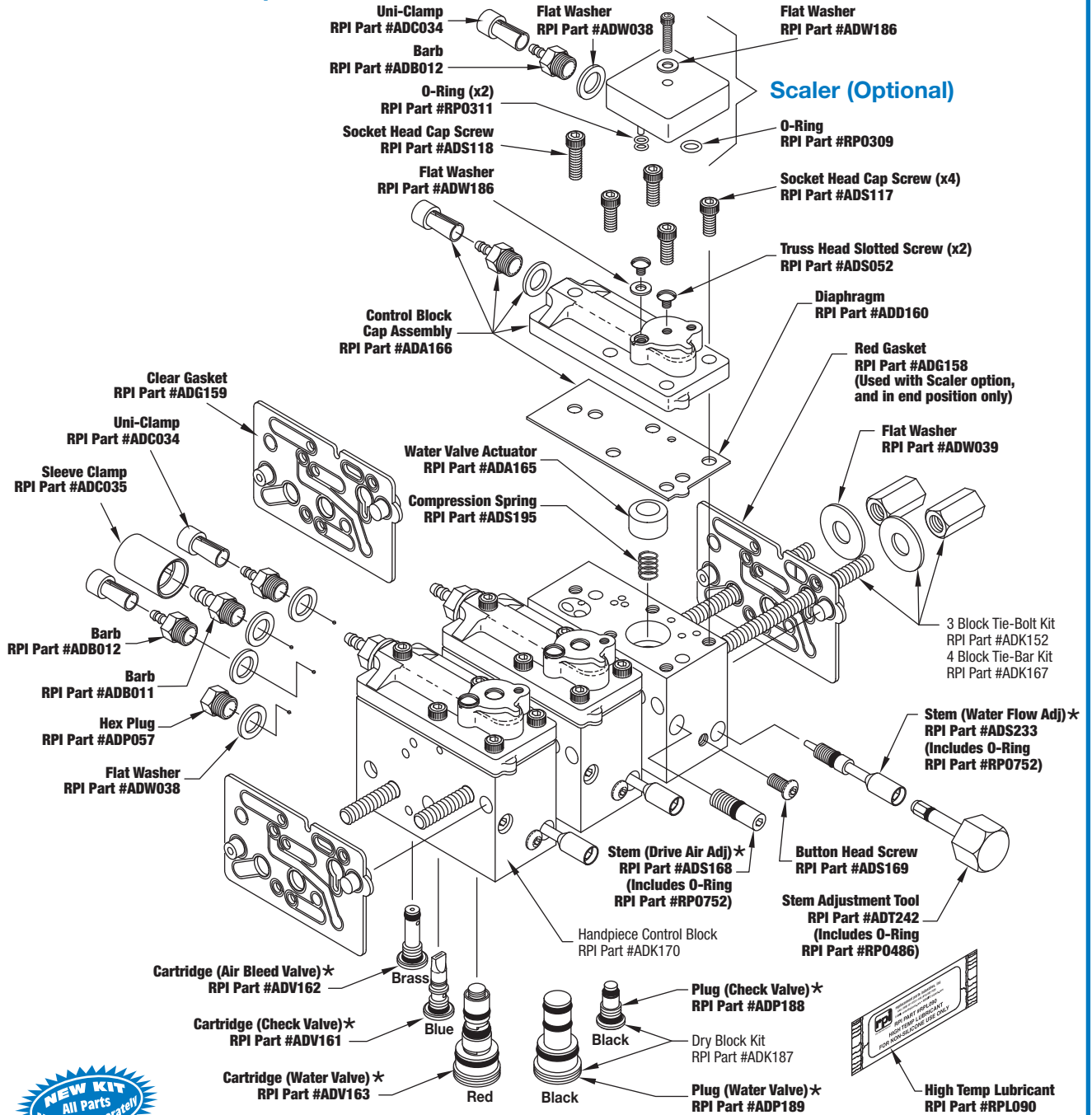

NEW KIT
All Parts
Also Sold Separately

* Apply a thin coat of High Temp Lubricant (RPI Part #RPL090) onto O-rings in Stems & Cartridges prior to assembly.

CONTROL BLOCK KIT (MAJOR)

RPI Part #ADK190

(Kit parts identified in bold text - All parts also sold separately)

With this Kit, you can easily replace Handpiece Control Block parts, or completely rebuild the Control Block. Save money and time with this Kit!

**FOR DETAILS ABOUT THIS KIT,
SEE PAGE 504**

SECTION

4

PAGE

503

UPDATED

02/12



RPI Part #ADK190

OEM Part # (No OEM Part # Available)

CONTROL BLOCK KIT (MAJOR)

- Kit includes Storage Case (RPI Part #RPC751)
- All parts also sold separately in quantities indicated below

Model: Handpiece Control Block Century Plus (OEM Part #38.0540.00)

With this Kit, you can easily replace Handpiece Control Block parts, or completely rebuild the Control Block. Save money and time with this Kit!

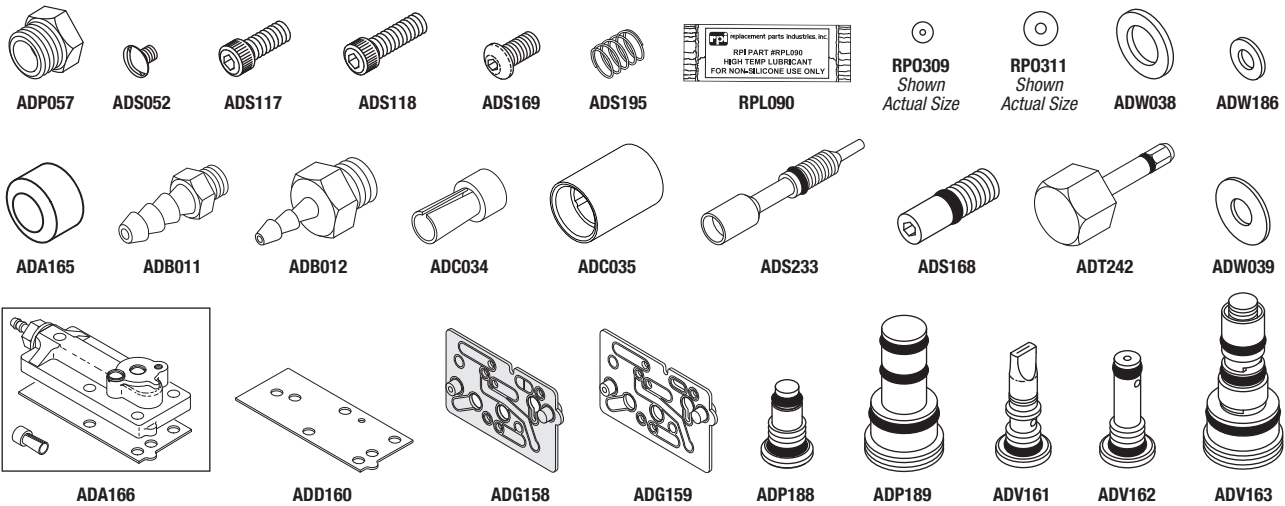
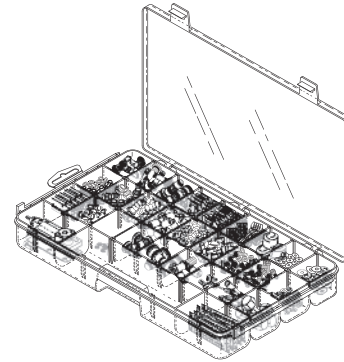

RPI PART #	OEM PART #	DESCRIPTION	KIT QTY	REORDER QTY (PER PKG)
▶ ADA165	38.0514.00	WATER VALVE ACTUATOR	3	3
▶ ADA166	38.0546.00	CONTROL BLOCK CAP ASSEMBLY	1	1
▶ ADB011	023-001-01	BARB	10	10
▶ ADB012	023-004-01 & 023.004.03	BARB	10	10
▶ ADC034	025.007.01	UNI-CLAMP	20	20
▶ ADC035	025-015-01	SLEEVE CLAMP	20	20
▶ ADD160	38-0519-01	DIAPHRAGM	10	10
▶ ADG158	38-0550-00	RED GASKET	5	5
▶ ADG159	38-0507-00	CLEAR GASKET	10	10
▶ ADP057	021-016-01 & 021.016.00	HEX PLUG	10	10
▶ ADP188	38.0646.00 & 38.0648.00 (Kit)	PLUG (CHECK VALVE)	3	3
▶ ADP189	38.0647.00 & 38.0648.00 (Kit)	PLUG (WATER VALVE)	3	3
▶ ADS052	001-002-00	TRUSS HEAD SLOTTED SCREW	10	10
▶ ADS117	001-024-00	SOCKET HEAD CAP SCREW	25	25
▶ ADS118	001-021-00	SOCKET HEAD CAP SCREW	25	25
▶ ADS168	38.0510.00	STEM (DRIVE AIR ADJ.)	3	3
▶ ADS169	002-118-00	BUTTON HEAD CAP SCREW	5	5
▶ ADS195	013-021-00	COMPRESSION SPRING	10	10
▶ ADS233	38.0516.00	STEM (WATER FLOW ADJ.)	4	1
▶ ADT242	38.1808.01 & 98.0867.02	STEM ADJUSTMENT TOOL	5	5
▶ ADV161	38-0518-00	CARTRIDGE (CHECK VALVE)	4	3
▶ ADV162	38-0517-00	CARTRIDGE (AIR BLEED VALVE)	4	3
▶ ADV163	38-0520-00	CARTRIDGE (WATER VALVE)	4	3
▶ ADW038	004-005-00	FLAT WASHER	50	50
▶ ADW039	004-036-00	FLAT WASHER	15	15
▶ ADW186	004-078-00	FLAT WASHER	5	5
▶ RPL090	98.0090.01	HIGH TEMP LUBRICANT	5	5
▶ RPO309	030-001-00	O-RING	12	12
▶ RPO311	030-003-00	O-RING	12	12

Call Us Toll-Free Monday–Friday, 8:00 AM–4:30 PM (Pacific Time), (800) 221-9723

Dental Equipment

Handpiece Control Block Century Plus (OEM Part #38.0540.00) (continued)



RPI Part #ADK170
OEM Part #38.0540.00

HANDPIECE CONTROL BLOCK

- Material: Nickel plated brass
 - Includes all parts as shown
 - Also available: Control Block Service Kit (RPI Part #ADK164) and Control Block Service Kit (Major) (RPI Part #ADK190)
- Model:** Handpiece Control Block Century Plus (OEM Part 38.0540.00)

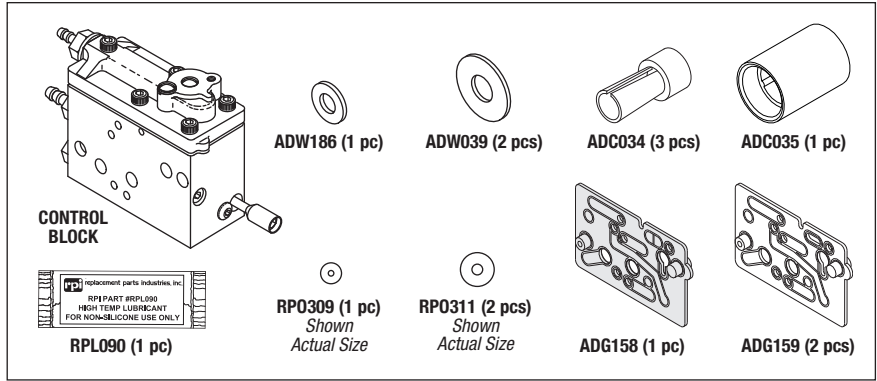

RPI Part #ADK164
OEM Part #38.0537.01

CONTROL BLOCK SERVICE KIT

- Includes all parts as shown
 - All parts also sold separately
 - Also available: Handpiece Control Block (RPI Part #ADK170) and Control Block Kit (Major) (RPI Part #ADK190)
- Model:** Handpiece Control Block Century Plus (OEM Part #38.0540.00)

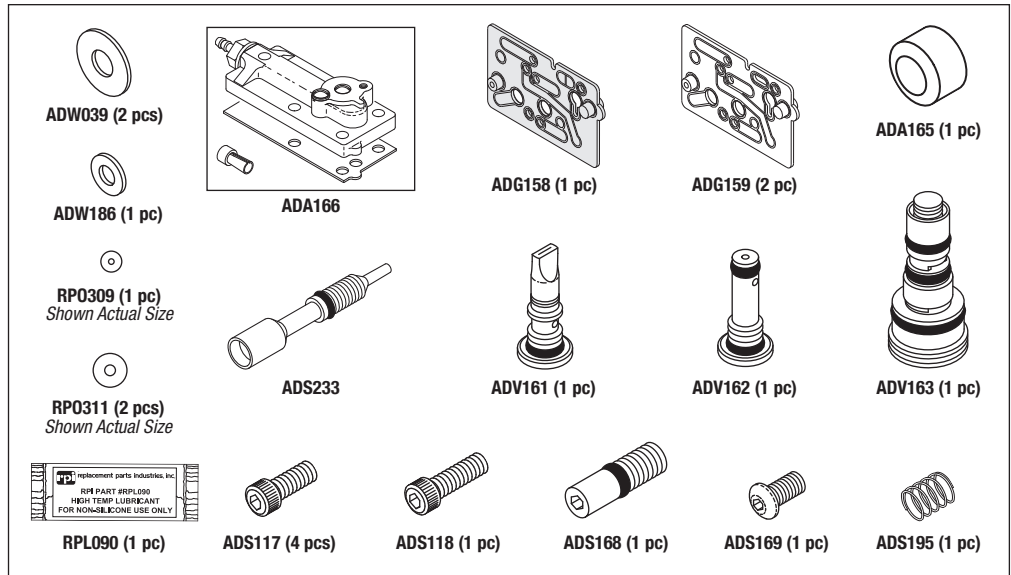

RPI Part #ADA166
OEM Part #38.0546.00

CONTROL BLOCK CAP ASSY

- Material: Nickel plated brass
 - Includes all parts as shown
 - Also included in: Control Block Kit (RPI Part #ADK164), Handpiece Control Block (RPI Part #ADK170) and Control Block Service Kit (Major) (RPI Part #ADK190)
- Model:** Handpiece Control Block Century Plus (OEM Part 38.0540.00)

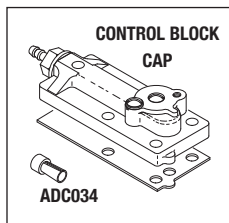

RPI Part #ADA165
OEM Part #38.0514.00

WATER VALVE ACTUATOR

- 3 per package; Material: Plastic
 - Also included in: Control Block Service Kit (RPI Part #ADK164)
 - Also available: Control Block Service Kit (Major) (RPI Part #ADK190)
- Model:** Handpiece Control Block Century Plus (OEM Part 38.0540.00)



RPI Part #ADK187
OEM Part #38.0648.00

DRY BLOCK KIT

- Material: Brass cartridges with black tops
 - Includes all parts as shown
 - Replaces: Cartridge (Water Valve) (RPI Part #ADV163) and Cartridge (Check Valve) (RPI Part #ADV161)
- Model:** Handpiece Control Block Century Plus (OEM Part 38.0540.00)

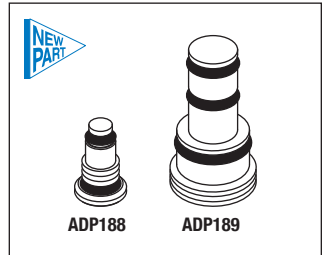

RPI Part #ADK152
OEM Part #38-0193-00

3 BLOCK TIE BOLT KIT

- Includes all parts as shown
 - (2) Kits are required
- Model:** Handpiece Control Block Century Plus (OEM Part 38.0540.00)

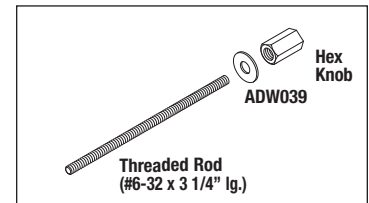

RPI Part #ADK167
OEM Part #38-0194-01 & 38-0504-08

4 BLOCK TIE BOLT KIT

- Includes all parts as shown
 - (2) Kits are required
- Model:** Handpiece Control Block Century Plus (OEM Part 38.0540.00)

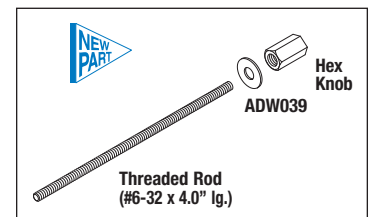

CENTURY II® HANDPIECE CONTROL BLOCK (OEM Part #38.0223.00)

Exploded View
(Kit parts identified in bold text - All parts also sold separately)

Universal Sleeve Tool
RPI Part #RPT296

Sleeve Clamp
RPI Part #ADC035

Uni-clamp (3 pcs)
RPI Part #ADC034

Barb 1/16"
RPI Part #ADB012

Barb 1/8"
RPI Part #ADB011

Washer (4 pcs)
RPI Part #ADW038

Gasket
RPI Part #ADG031

Water Cover Valve Kit
RPI Part #ADK144

Air Cover Valve Kit
RPI Part #ADK143

Set Screw (Pre-coated)
RPI Part #RPH435

Adjusting Screw
RPI Part #ADS055

Valve Stem Needle
RPI Part #ADS007

O-Ring (2 pcs)
RPI Part #RPO312

Valve Core Removal/Syringe Tool
RPI Part #RPT264
(Can also be used to adjust Drive Air Screw)

Body Knob
See page 4-507 for complete options.

Also available:

Hex Ball Driver
RPI Part #RPT297

- Use to remove and install Water Cover Valve

RPI Part #ADK142
OEM Part #38-0223-00

HANDPIECE CONTROL BLOCK

- Material: Brass with nickel plating
- Includes all parts as shown

Model: Handpiece Control Block Century II (OEM Part #38.0223.00)

RPI Block includes Removable Set Screw!

RPI Handpiece Control Block includes removable Set Screw for easy access to the stem!

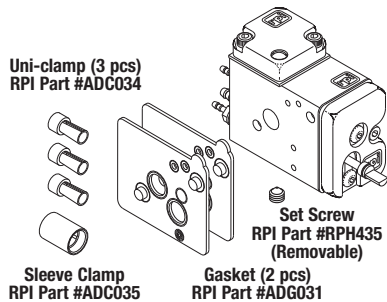

RPI Part #ADK150
OEM Part # (No OEM Part # Available)

MASTER CONTROL BLOCK KIT

- Includes all parts as shown

Model: Handpiece Control Block Century II (OEM Part #38.0223.00)

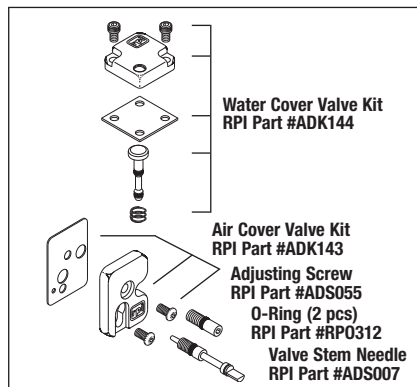

RPI Part #ADK094
OEM Part #90-0321-00

CONTROL BLOCK SERVICE KIT

- Includes all parts as shown

Model: Handpiece Control Block Century II (OEM Part #38.0223.00)

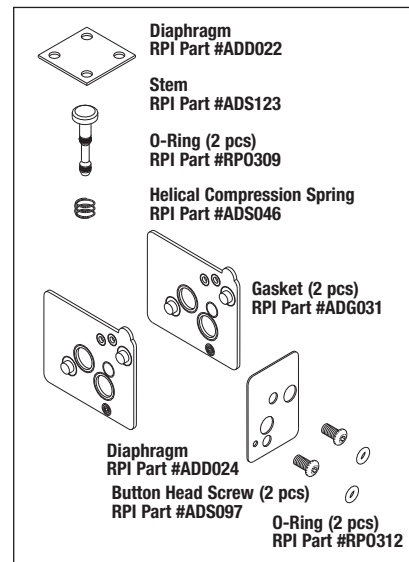

RPI Part #ADK152
OEM Part #38-0193-00

3 BLOCK TIE BOLT KIT

- Includes all parts as shown

Model: Handpiece Control Block Century II (OEM Part #38.0223.00)

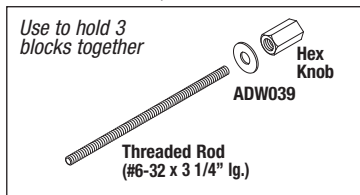

RPI Part #ADK167
OEM Part #38-0194-01 & 38-0504-08

4 BLOCK TIE BOLT KIT

- Includes all parts as shown

Model: Handpiece Control Block Century II (OEM Part #38.0223.00)

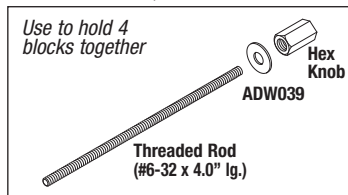

See page 4-507
for information on the
Air Cover Valve Kit and
Water Cover Valve Kit!

Dental Equipment

Handpiece Control Block Century II® (OEM Part #38.0223.00) (continued)

RPI Part #ADK143
OEM Part #90-0304-00

AIR COVER VALVE KIT

- Includes all parts as shown
- Model:** Handpiece Control Block Century II (OEM Part #38.0223.00)

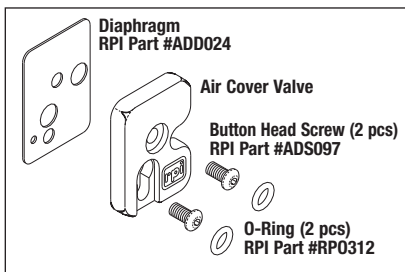

RPI Part #ADK144
OEM Part # (No OEM Part # Available)

WATER COVER VALVE KIT

- Includes all parts as shown
- Model:** Handpiece Control Block Century II (OEM Part #38.0223.00)

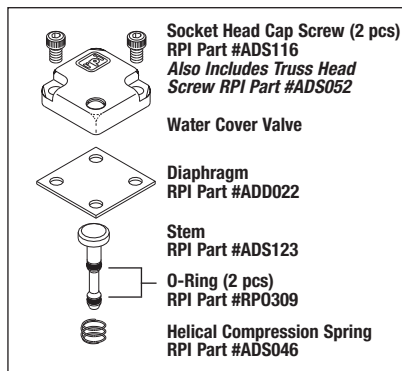

Knobs to fit Handpiece Control Block Century II® (OEM Part #38.0223.00)

RPI Part #ADK171
OEM Part # (No OEM Part # Available)

BLACK KNOB SET

- Includes all parts as shown
- 3/16" diameter "D" shaped shaft
- Fits:** Needle Valve for HPCB & Valve for Master Control Block

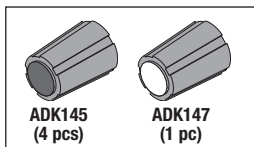

RPI Part #ADK172
OEM Part # (No OEM Part # Available)

GRAY KNOB SET

- Includes all parts as shown
- 3/16" diameter "D" shaped shaft
- Fits:** Needle Valve for HPCB & Valve for Master Control Block

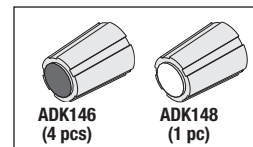

RPI Part #ADK145
OEM Part #027-017-00

BLACK BODY KNOB W/ BLUE DOT

- 4 per package; 3/16" diameter shaft "D" shaped shaft
- Fits:** Needle Valve for HPCB & Valve for Master Control Block



RPI Part #ADK146
OEM Part #027-017-01

GRAY BODY KNOB W/ BLUE DOT

- 4 per package; 3/16" diameter "D" shaped shaft
- Fits:** Needle Valve for HPCB & Valve for Master Control Block



RPI Part #ADK147
OEM Part #027-018-00

BLACK BODY KNOB W/ YELLOW DOT

- 4 per package; 3/16" dia. "D" shaped shaft
- Fits:** Needle Valve for HPCB & Valve for Master Control Block



RPI Part #ADK148
OEM Part #027-018-01

GRAY BODY KNOB W/ YELLOW DOT

- 4 per package; 3/16" dia. "D" shaped shaft
- Fits:** Needle Valve for HPCB & Valve for Master Control Block



Handpiece Control Block Century Water Valve Assembly (OEM Part #38.0098.00)

RPI Part #ADK071
OEM Part # (No OEM Part # Available)

WATER VALVE SERVICE KIT

- Includes all parts as shown
- Model:** Handpiece Control Block Century Water Valve Assembly (OEM Part #38.0098.00)

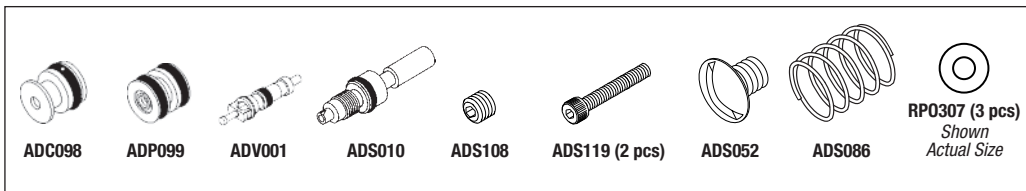

Control Head Components

RPI Part #ADS075
OEM Part #40-0250-00

AIR ACTUATED ELECTRIC SWITCH

- Normally open; 5A
- Includes: (2 pcs) Wire Nut (RPI Part #RPT017), 1/16" tubing barb (#10-32 port) and panel mount hardware

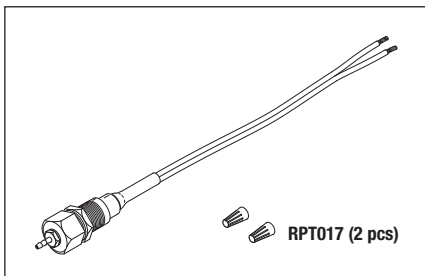

RPI Part #PCG760
OEM Part #026.083.01

PRESSURE GAUGE

- 1-3/4" w x 1/2" h x 2-1/4" lg.
- 0-60 PSI; 0-4 Bar
- Port: #10-32 threaded inlet
- Includes all parts as shown

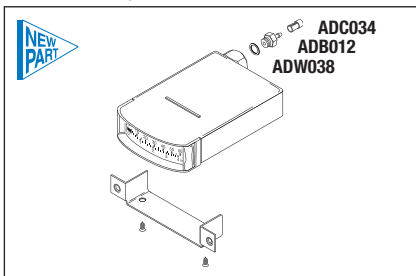

RPI Part #PCL768
OEM Part #24.0100.03

AIR INDICATOR (GREEN)

- Nickel plated brass
- Black bezel
- Port: #10-32 threaded inlet with 1/16" barb
- Mounts in 1/2" dia. hole
- Includes all parts as shown

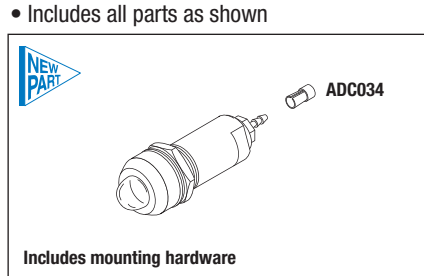

RPI Part #PCV766
OEM Part # (No OEM Part # Available)



VALVE TOGGLE SWITCH

- Replacement for Purge **or** On/Off Toggle Valve
- Swivels for easy connection to tubing
- Material: Nickel plated brass
- Port: #10-32 threaded inlet with 1/16" barb
- Mounts in 1/2" dia. hole
- Includes all parts as shown

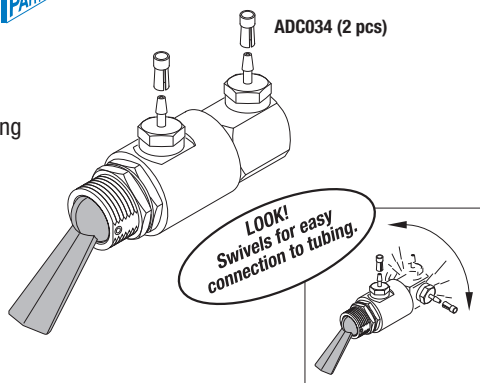

ADC034 (2 pcs)
ADB012 (2 pcs)
ADW038 (2 pcs)



RPI Part #PCV767
OEM Part #026.073.02

CHECK VALVE

- Material: Brass body
- Port: #10-32 threaded inlet with 1/16" barb
- Allows water or air to flow in one direction only
- Includes all parts as shown

RPI Part #ADV179
OEM Part #33-0008-00

CUP FILL TOGGLE VALVE (BLACK)

- Includes all parts as shown
 - 2-way momentary valve
- Fits:** Dental systems prior to 1982 with cup fill towers

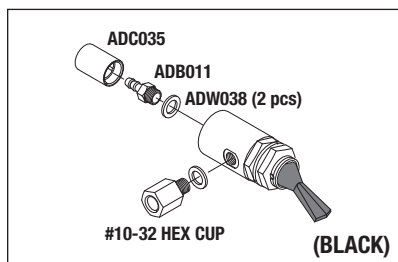

RPI Part #ADP049
OEM Part #011-024-00

STRAIGHT PIN

- 10 per package
 - Material: Stainless steel
 - Size: .062 dia. x .460 Lg.
- Fits:** Push Button Valve & 2-Way Toggle Valves

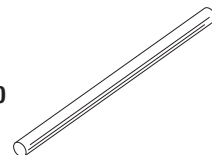

RPI Part #ADV180
OEM Part # (No OEM Part # Available)

CUP FILL TOGGLE VALVE (GRAY)

- Includes all parts as shown
 - 2-way momentary valve
- Fits:** Dental systems prior to 1982 with cup fill towers

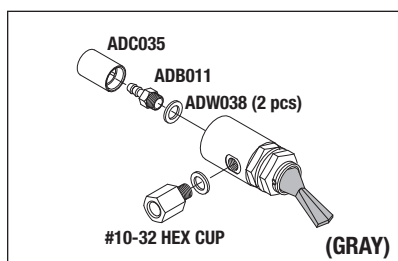

RPI Part #ADP050
OEM Part #011-038-00

STRAIGHT PIN

- 10 per package
 - Material: Stainless steel
 - Size: .062 dia. x .430 Lg.
- Fits:** Micro-Selector Valve, 2-Way Routing Selector Valve, 2-Way and 3-Way Toggle Valve & Autoclavable and Continental Syringes

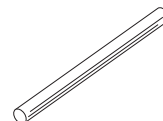

RPI Part #ADV181
OEM Part #33-0034-01

2 WAY MOMENTARY TOGGLE VALVE (BLACK)

- Includes all parts as shown
 - 2-way momentary valve
- Fits:** Dental systems with water purge and air brake systems

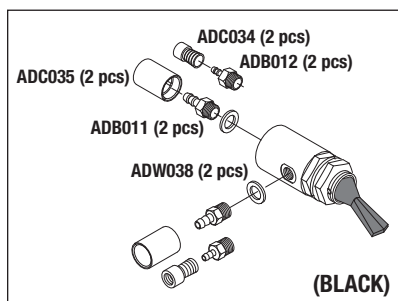

RPI Part #ADP051
OEM Part #011-039-00

STRAIGHT PIN

- 10 per package
 - Material: Stainless steel
 - Size: .062 dia. x .450 Lg.
- Fits:** Valve Assemblies & Toggle 3-Way Cartridge

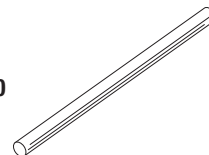

RPI Part #ADV182
OEM Part # (No OEM Part # Available)

2 WAY MOMENTARY TOGGLE VALVE (GRAY)

- Includes all parts as shown
 - 2-way momentary valve
- Fits:** Dental systems with water purge and air brake systems

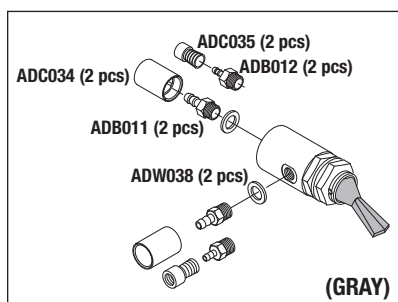

RPI Part #ADV244
OEM Part #33.0138.00 & 29.1085.00



MICRO VALVE

- Material: Nickel plated brass
 - 1/16" Barbs (use with 1/16" ID x 1/8" OD Tubing)
 - 3-Way Normally Closed
- Models:** Foot Control Accessory Button (OEM Part #38.0612.00) & Wet/Dry Toggle Valve (OEM Part #38.0604.00)

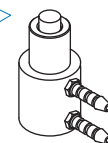

Dental Equipment

Utility Module (OEM Part #24-0352-00)

UTILITY MODULE (OEM Part #24-0352-00)

Exploded View
(Kit parts identified in bold text -
All parts also sold separately)

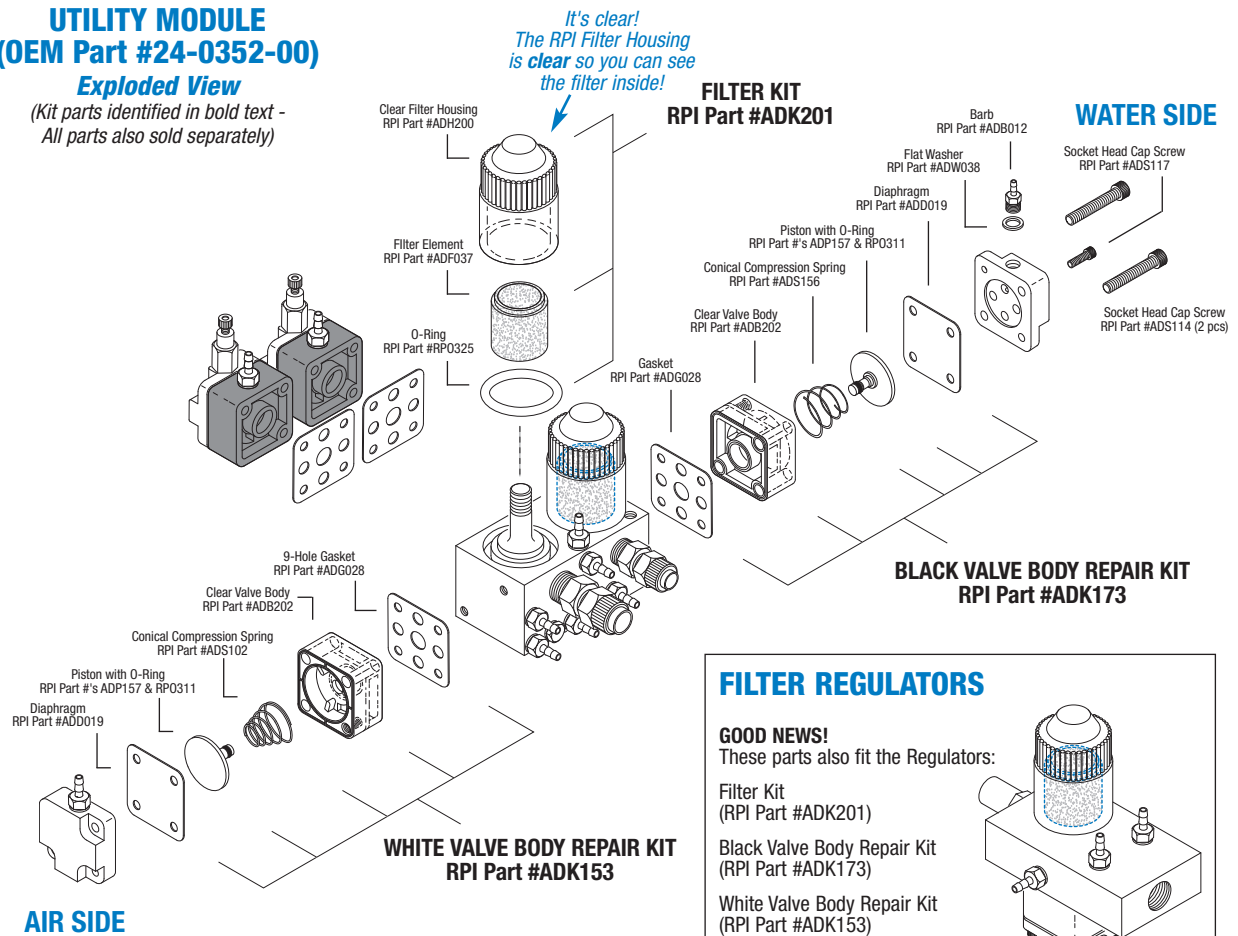

FILTER REGULATORS

GOOD NEWS!
These parts also fit the Regulators:

- Filter Kit (RPI Part #ADK201)
- Black Valve Body Repair Kit (RPI Part #ADK173)
- White Valve Body Repair Kit (RPI Part #ADK153)

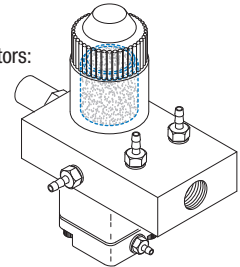

RPI Part #ADK153
OEM Part #24-0135-00



WHITE VALVE BODY REPAIR KIT

- This kit has been upgraded to include the Clear Valve Body (RPI Part #ADB202)
- Includes all parts as shown

Fits: Air Regulator Valve "White" Bodies (OEM Part #24-0135-00)

RPI Part #ADK173
OEM Part #24-0355-00



BLACK VALVE BODY REPAIR KIT

- This kit has been upgraded to include the Clear Valve Body (RPI Part #ADB202)
- Includes all parts as shown

Fits: Water Regulator Valve "Black" Bodies (OEM Part #24-0355-00)

RPI Part #ADK201
OEM Part #24-0229-00/
24-0234-00/030-019-00



FILTER KIT

- New round design for enhanced performance
- The RPI Filter Housing is clear so you can see when the filter needs replacement without having to remove the housing
- Includes all parts as shown

Models: See top of page 510 for Models this part fits.

CLEAR VALVE BODY!

RPI's valve body is clear for easy troubleshooting!

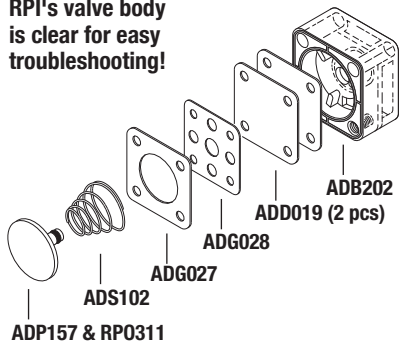

All parts in Kit also sold separately

CLEAR VALVE BODY!

RPI's valve body is clear for easy troubleshooting!

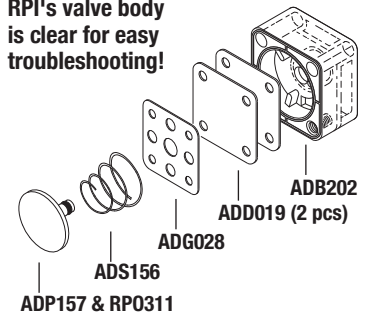

All parts in Kit also sold separately

CLEAR HOUSING!

The RPI filter housing is clear so you can see when the filter needs replacement without having to remove the housing. It's the RPI Advantage.

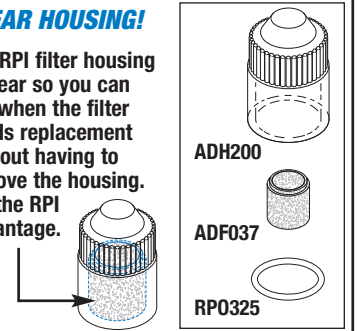

RPI Part #ADK201
OEM Part #'s
24-0229-00 (A-dec Filter Housing)/
24-0234-00 (A-dec Filter Element-1/pkg)/
030-019-00 (A-dec O-ring)
62R052 (Pelton & Crane and Marus Filter Housing)/
62R050 (Pelton & Crane and Marus Filter Element)/
007R019 (Pelton & Crane and Marus O-Ring)

FILTER KIT

- New round design for enhanced performance
 - The RPI Filter Housing is clear so you can see when the filter needs replacement without having to remove the housing
 - Includes all parts as shown
- Models: See Chart below.**

THE RPI ADVANTAGE!

The RPI filter housing is clear so you can see when the filter needs replacement without having to remove the housing.

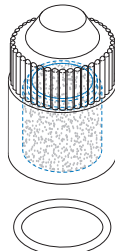

THE RPI FILTER KIT (RPI PART #ADK201) FITS THE FOLLOWING DENTAL DELIVERY SYSTEM COMPONENTS

A-dec	Filter Regulator	24-0168-00
	Filter Regulator	24-0170-00
	Filter Regulator	24-0175-00
	Utility Module	24-0352-00
Chapman-Hoffman	J-Box Shut-Off Valve Assy	19-075-00 & 19-081-00
DCI	Filter Regulator	7212
	Filter for Air or Water	7246
Marus	Master Air Shut-Off Valve	55R346
	Master Water Shut-Off Valve	55R347
Pelton & Crane	Master Air Shut-Off Valve	55R346
	Master Water Shut-Off Valve	55R347

RPI Part #ADH200
OEM Part #24-0229-00 (A-dec Filter Housing)/
62R052 (Pelton & Crane and Marus Filter Housing)

FILTER HOUSING

- The RPI Filter Housing is clear so you can see when the filter needs replacement without having to remove the housing

Models: See Chart to the left.

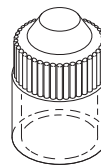

CLEAR HOUSING!

RPI Part #ADF037
OEM Part #24-0234-01 (A-dec Filter Element-6/pkg)/
62R050 (Pelton & Crane and Marus Filter Element)

FILTER ELEMENT

- 6 per package
- Plastic (white)
- 60-100 micron filtration for air or water

Models: See Chart to the left.



RPI Part #RPO325

OEM Part #
030-019-00 (A-dec O-ring)/
007R019 (Pelton & Crane and Marus O-Ring)
Industry Part #AS568-019

O-RING

- 12 per package
- Buna-N (Nitrile), 70 Duro
- .801" ID x .941" OD x .070" C/S

Models: See Chart to the left.

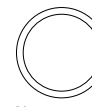

Not to scale.

RPI Part #ADF036
OEM Part #19-0220-01/
19-0220-00

FILTER

- 5 per package
- Material: Sintered bronze
- Size: .625" OD x .062" Thk
- Also included in: Water Filter Service Kit (RPI Part #ADK072)

- Service Tip: Replace O-Ring (RPI Part #RPO317) when replacing filter

Models: Water Filter Regulator (OEM Part #40-0654-00) & In Line Filter Assembly (OEM Part #19-0100-00)

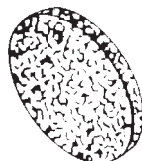

RPI Part #ADF037
OEM Part #24-0234-01
(A-dec Filter Element-6/pkg)/
62R050 (Pelton & Crane
and Marus Filter Element)

FILTER ELEMENT

- 6 per package
- Material: Plastic (white)
- 60-100 micron filtration for air or water
- Service Tip: Replace O-Ring (RPI Part #RPO325) when replacing filter element
- Also included in: Filter Kit (RPI Part #ADK201)

Models: See Chart above for RPI Part #ADK201

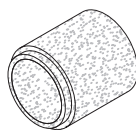

RPI Part #ADF069
OEM Part #97-0280-00/
97-0280-02

FILTER ELEMENT

- Material: Plastic (white)
- 40 micron filtration
- Service Tip: Replace O-Ring (RPI Part #RPO322) when replacing filter element

Models: Air Filter Regulator (OEM Part #026-021-01) & Filter/Moisture Separator (OEM Part #026-066-00)

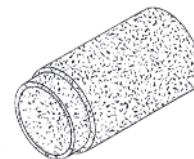

RPI Part #RPO322
OEM Part #030-023-02
Industry Part #2-023

O-RING

- 12 per package
- Buna-N (Nitrile)
- Hardness: 70 Duro
- Size: 1.051" ID x 1.191" OD x .070" C/S

Models: Air Filter Regulator (OEM Part #026-021-01) & Filter/Moisture Separator (OEM Part #026-066-00)

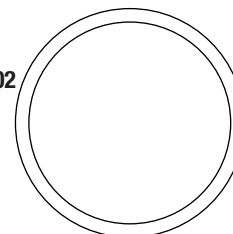

RPI Part #RPO317
OEM Part #030-016-00
Industry Part #AS568-016

O-RING

- 12 per package
 - Material: Buna-N (Nitrile), 70 Duro
 - Size: .614" ID x .754" OD x .070" C/S
- Models: Water Filter Regulator (OEM Part #40-0654-00), In Line Filter Assembly (OEM Part #19-0100-00)**

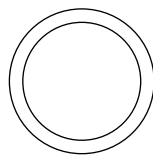

RPI Part #RPO325
OEM Part #030-019-00
(A-dec O-ring)/007R019
(Pelton & Crane and
Marus O-Ring)
Industry Part #AS568-019

O-RING

- 12 per package
 - Material: Buna-N (Nitrile), 70 Duro
 - Size: .801" ID x .941" OD x .070" C/S
 - Also included in: Filter Kit (RPI Part #ADK201)
- Models: See Chart above for RPI Part #ADK201**

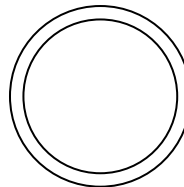

O-Ring illustrations are actual size

Dental Equipment

Water Coolant Relay Assembly 500 Series (OEM Part #38.1810.00), Coolant Air Valve (OEM Part #22-0940-00) and Coolant Water Valve (OEM Part #'s 22-0960-00 & 22-0790-00)

500 Series WATER COOLANT RELAY ASSEMBLY (OEM Part #38.1810.00)

Exploded View

(Kit parts identified in bold text - All parts also sold separately)

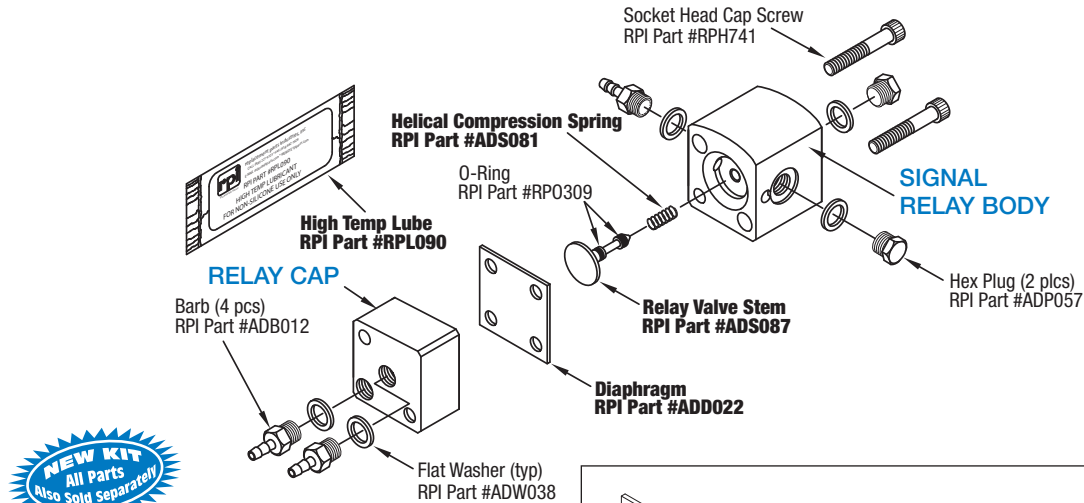

RPI Part #ADK252
OEM Part #38.1810.00 (Relay Assy)

WATER COOLANT RELAY KIT

- Includes all parts as shown
- Fits:** Water Coolant Relay Assembly 500 Series (OEM Part #38.1810.00)

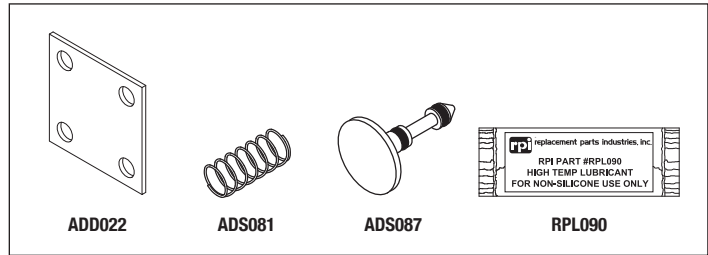

RPI Part #ADK095
OEM Part #90-0012-00

AIR COOLANT VALVE SERVICE KIT

- Includes all parts as shown
- Fits:** Coolant Air Valve (OEM Part #22-0940-00)

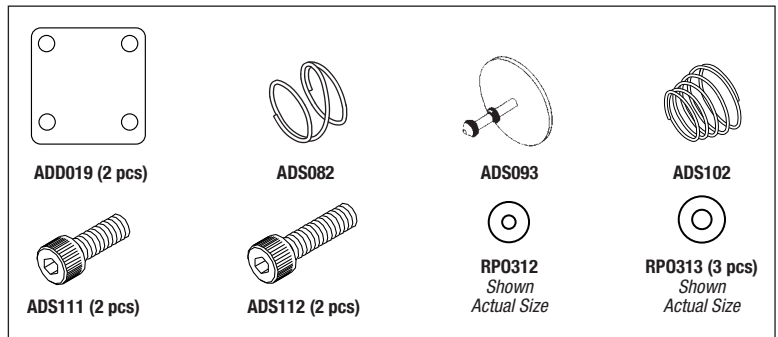

RPI Part #ADK096
OEM Part #90-0014-00

WATER COOLANT VALVE SERVICE KIT

- Includes all parts as shown
- Fits:** Coolant Water Valve (OEM Part #'s 22-0960-00 & 22-0790-00)

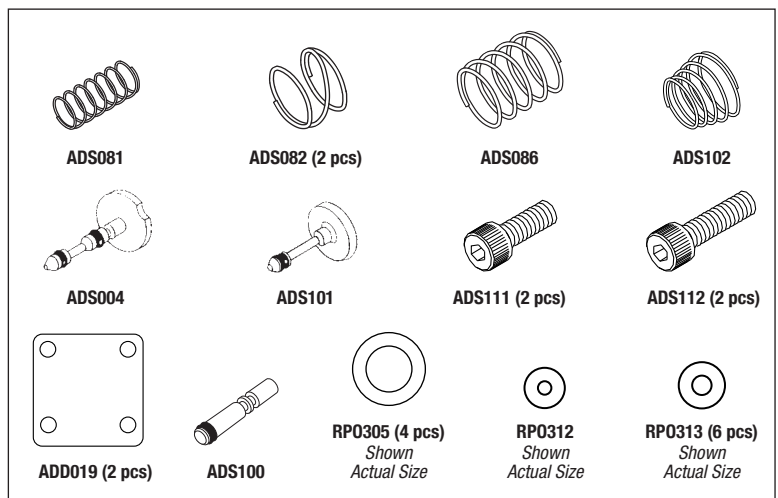

RPI Part #ADK072
OEM Part #90-0070-00

WATER FILTER SERVICE KIT

- Includes all parts as shown

Model: Water Filter-Regulator (OEM Part #40-0654-00)



RPI Part #ADK074
OEM Part #90-0030-00

AIR FILTER REGULATOR SERVICE KIT

- Includes all parts as shown

Model: Air Filter Regulator (OEM Part #026-021-01)

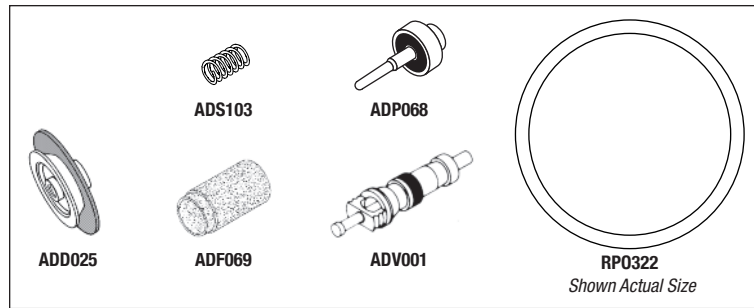

RPI Part #ADK131
OEM Part #90-0040-00

AIR & WATER REGULATOR SERVICE KIT

- Includes all parts as shown

Model: Air and Water Filter Regulator (OEM Part #40-0654-00)

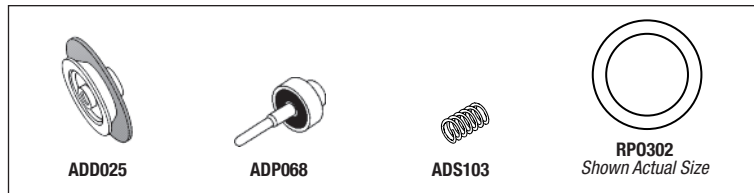

RPI Part #ADK076
OEM Part #90-0090-00

SHUT-OFF VALVE SERVICE KIT (AIR & WATER)

- Includes all parts as shown

Model: Air and Water Shut-Off Valve (Air-Operated) (OEM Part #30-0330-00)

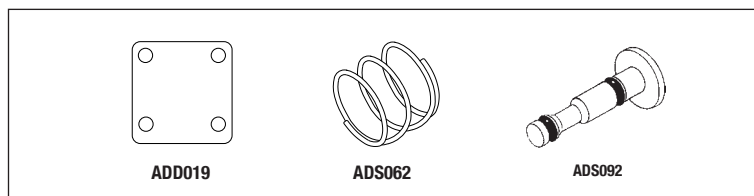

NOTES:

Dental Equipment

Foot Control 300 Series (OEM Part #38.1821.00), 500 Series (OEM Part #38.1805.00), Foot Control (OEM Part #38-0050-00), Foot Control II (OEM Part #38-0254-00), Foot Control III (OEM Part #'s 38.1601.00, 38.1603.00, & 38.1700.00) & Foot Control Lever Action (OEM Part #38-0200-00)



FOOT CONTROL III SERVICE KIT

RPI Part #ADK245

(Kit parts identified in bold text - All parts also sold separately)

With this Service Kit, you can rebuild the air and water controls or rebuild both!

FOR DETAILS ABOUT THIS KIT, SEE PAGE 514

FOOT CONTROL (OEM Part #'s 300 Series (38.1821.00), 500 Series (38.1805.00), Foot Control (38-0050-00), Foot Control III (38.1601.00, 38.1603.00 & 38.1700.00) Exploded View

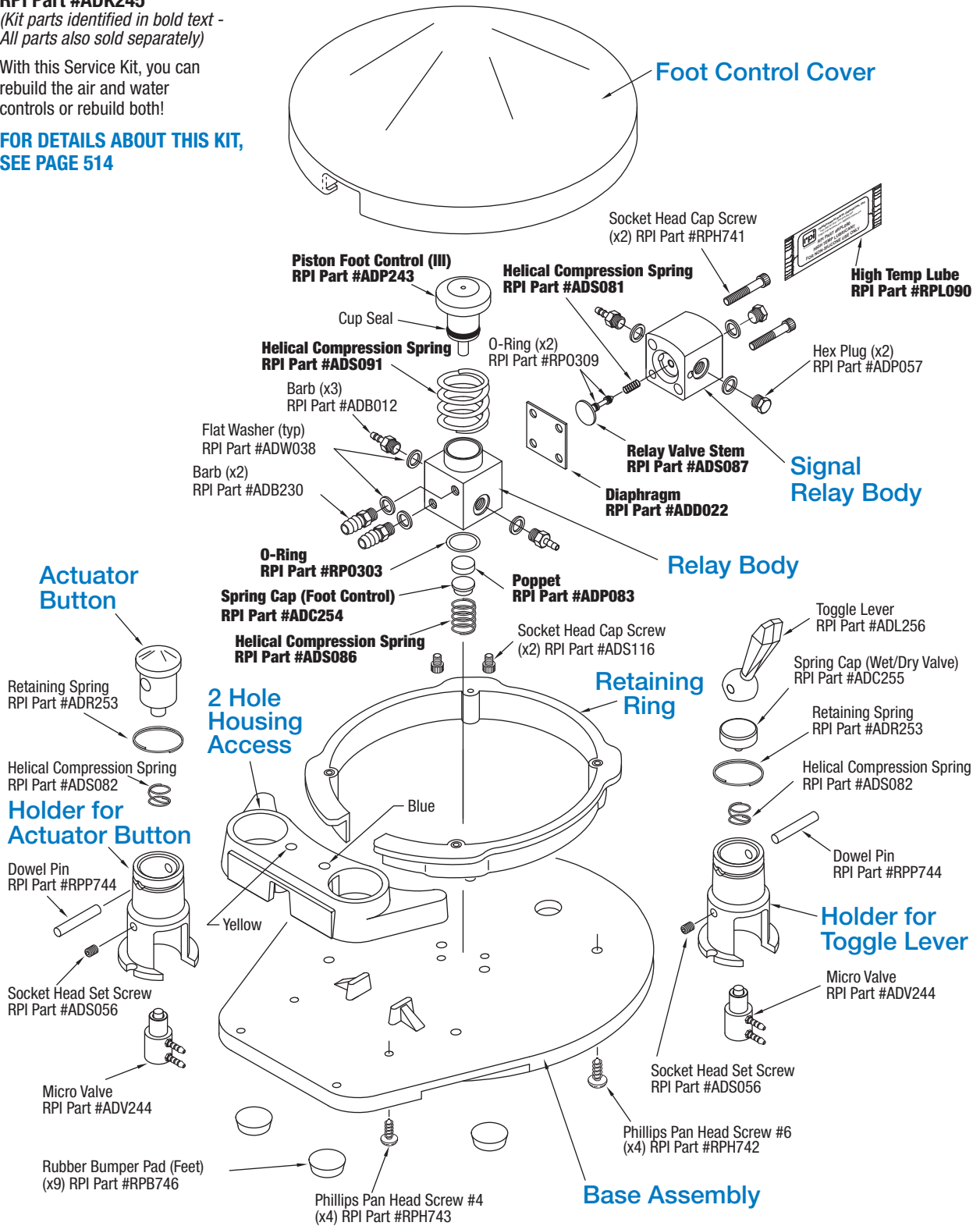

Foot Control 300 Series (OEM Part #38.1821.00), 500 Series (OEM Part #38.1805.00), Foot Control (OEM Part #38-0050-00), Foot Control II (OEM Part #38-0254-00), Foot Control III (OEM Part #'s 38.1601.00, 38.1603.00, & 38.1700.00) & Foot Control Lever Action (OEM Part #38-0200-00) (continued)



RPI Part #ADK245
OEM Part #90.0593.00

FOOT CONTROL III SERVICE KIT

- Includes all parts as shown

Models:

Foot Control 300 Series (OEM Part #38.1821.00),
 Foot Control 500 Series (OEM Part #38.1805.00), &
 Foot Control III (OEM Part #'s 38.1601.00,
 38.1603.00 & 38.1700.00)

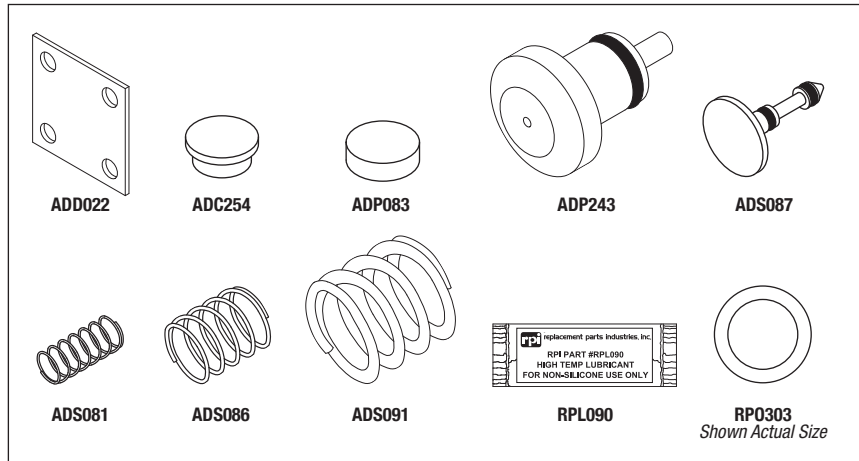

RPI Part #ADK089
OEM Part #90-0312-00

FOOT CONTROL II SERVICE KIT

- Includes all parts as shown

Model: Foot Control II (OEM Part #38-0254-00)

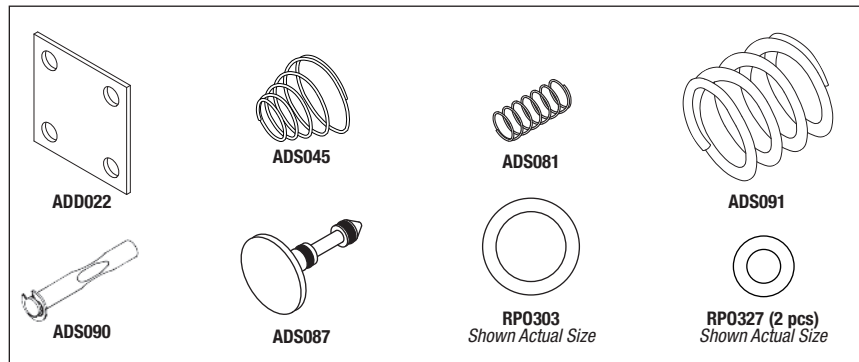

RPI Part #ADK088
OEM Part #90-0010-00

FOOT CONTROL SERVICE KIT

- Includes all parts as shown

Model: Foot Control (OEM Part #38-0050-00)

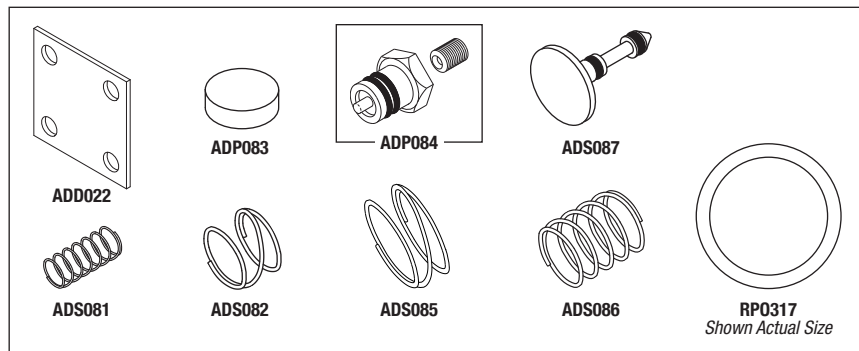

RPI Part #ADK122
OEM Part #90-0313-00

FOOT CONTROL SERVICE KIT (LEVER)

- Includes all parts as shown

Model: Foot Control Lever Action (OEM Part #38-0200-00)

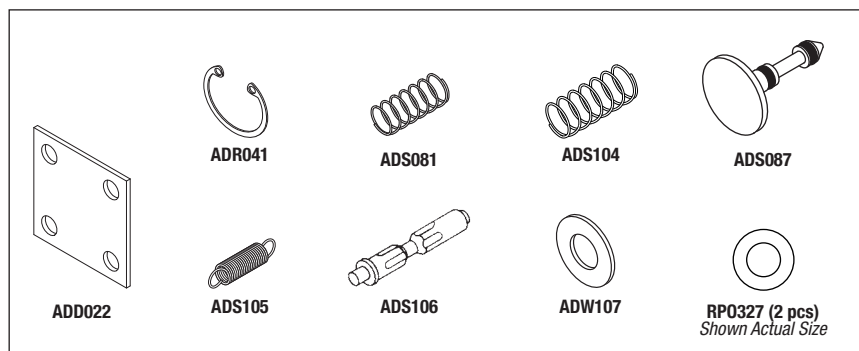

Dental Equipment

Foot Control 300 Series (OEM Part #38.1821.00), 500 Series (OEM Part #38.1805.00), Foot Control (OEM Part #38-0050-00), Foot Control II (OEM Part #38-0254-00), Foot Control III (OEM Part #'s 38.1601.00, 38.1603.00, & 38.1700.00) & Foot Control Lever Action (OEM Part #38-0200-00) (continued)

RPI Part #ADL256
OEM Part #38.0075.09 (Surf 6),
38.0074.00 (Black), 38.0074.01
(Gray), & 38.0075.03 (Surf 6
with Pin & Retaining spring)

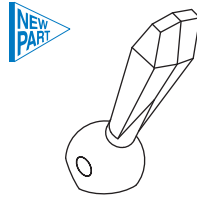

TOGGLE LEVER

- Material: Thermoplastic Rubber; Color: Gray

Models:

Foot Control 300 Series (OEM Part #38.1821.00),
Foot Control 500 Series (OEM Part #38.1805.00),
Foot Control (OEM Part #38-0050-00),
Foot Control II (OEM Part #38-0254-00),
Foot Control III (OEM Part #'s 38.1601.00, 38.1603.00, & 38.1700.00) &
Foot Control Lever Action (OEM Part #38-0200-00)

RPI Part #ADV244
OEM Part #33.0138.00 &
29.1085.00

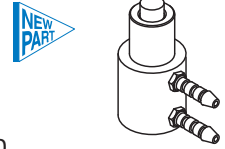

MICRO VALVE

- Material: Nickel plated brass
- 1/16" Barbs (use with 1/16" ID x 1/8" OD Tubing)
- 3-Way Normally Closed

Models:

Foot Control 300 Series (OEM Part #38.1821.00),
Foot Control 500 Series (OEM Part #38.1805.00),
Foot Control (OEM Part #38-0050-00),
Foot Control II (OEM Part #38-0254-00),
Foot Control III (OEM Part #'s 38.1601.00, 38.1603.00, & 38.1700.00) &
Foot Control Lever Action (OEM Part #38-0200-00)

RPI Part #RPP744
OEM Part #011.016.00

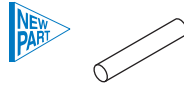

DOWEL PIN

- 10 per package
- Material: Stainless steel
- Size: .125" dia. x .625" lg

Models:

Foot Control 300 Series (OEM Part #38.1821.00),
Foot Control 500 Series (OEM Part #38.1805.00),
Foot Control (OEM Part #38-0050-00),
Foot Control II (OEM Part #38-0254-00),
Foot Control III (OEM Part #'s 38.1601.00, 38.1603.00, & 38.1700.00) &
Foot Control Lever Action (OEM Part #38-0200-00)

RPI Part #RPB746
OEM Part #017.007.01



RUBBER BUMPER PAD (FEET)

- 28 per package
- Material: Gray polyurethane with adhesive backing
- Size: .50" dia. x .14" H

Models:

Foot Control 300 Series (OEM Part #38.1821.00),
Foot Control 500 Series (OEM Part #38.1805.00),
Foot Control (OEM Part #38-0050-00),
Foot Control II (OEM Part #38-0254-00),
Foot Control III (OEM Part #'s 38.1601.00, 38.1603.00, & 38.1700.00) &
Foot Control Lever Action (OEM Part #38-0200-00)

NOTES:

Blank lines for notes.

RPI Part #ADK080

OEM Part # (No OEM Part # Available)

BARB KIT

- Kit includes 12-Compartment Storage Case (RPI Part #RPB415)
- All parts also sold separately in quantities indicated below

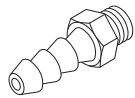
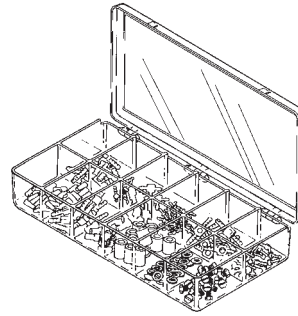

ADB011

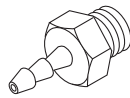

ADB012

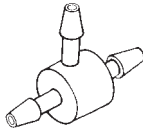

ADB013



ADB014

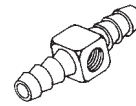

ADB015

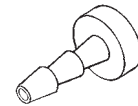

ADB016

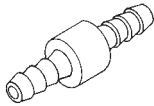

ADB018

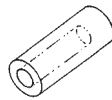

ADC017

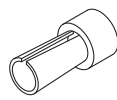

ADC034

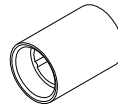

ADC035



ADP057



ADW038

RPI PART #	OEM PART#	DESCRIPTION	MATERIAL	FITS	KIT QTY	REORDER QTY (PER PKG)
ADB011	023-001-01	1/8" BARB TO #10-32 MALE THREAD	BRASS	1/8" ID TUBING	20	10
ADB012	023.004.03*	1/16" BARB TO #10-32 MALE THREAD	BRASS	1/16" ID TUBING	20	10
ADB013	023-014-01	1/16" BARB TEE	NYLON®	1/16" ID TUBING	20	10
ADB014	023-019-03**	1/16" INLINE BARB	BRASS	1/16" ID TUBING	20	10
ADB015	023-022-00	1/8" BARB TEE-BODY WITH #10-32 FEMALE THREAD	BRASS	1/8" ID TUBING	10	5
ADB016	023-030-00	1/16" BARB TUBING PLUG	BRASS	1/16" ID TUBING	20	10
ADB018	023-045-01	1/8" INLINE BARB	BRASS	1/8" ID TUBING	10	5
ADC017	023-031-01	1/16" BARB CAP	PLASTIC	1/16" OD BARB	20	10
ADC034	025.007.01	UNI-CLAMP	PLASTIC	1/8" OD TUBING	40	20
ADC035	025-015-01	SLEEVE CLAMP	PLASTIC	1/4" OD TUBING	20	20
ADP057	021.016.00***	HEX PLUG WITH #10-32 MALE THREAD	BRASS	#10-32 FEMALE THREAD	20	10
ADW038	004-005-00	FLAT WASHER (.187" ID x .312" OD x .031" thk)	NYLON®	#10-32 MALE THREAD	100	50

* 1/16" BARB TO #10-32 MALE THREAD (RPI PART #ADB012) ALSO REFERS TO OEM PART#023-004-01.

** 1/16" INLINE BARB (RPI PART #ADB014) ALSO REFERS TO OEM PART#'s 023-019-01 & 023-019-02.

*** HEX PLUG WITH #10-32 MALE THREAD (RPI PART #ADP057) ALSO REFERS TO OEM PART#021-016-01.

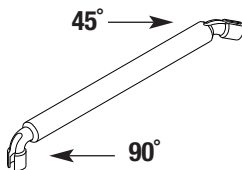

RPI Part #RPT294

OEM Part # (No OEM Part # Available)

1/8" SLEEVE TOOL

- Use on 1/8" OD tubing
- Use to install all 1/8" sleeve clamps and Uni-Clamp (RPI Part #ADC034)
- The tool provides 90° and 45° angles for ease of use
- ~5" lg.

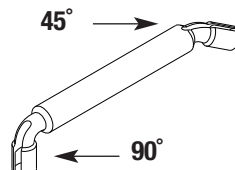

RPI Part #RPT295

OEM Part # (No OEM Part # Available)

1/4" SLEEVE TOOL

- Use on 1/4" OD tubing
- Use to install all 1/4" sleeve clamps and Uni-Clamp (RPI Part #ADC035)
- The tool provides 90° and 45° angles for ease of use
- ~5" lg.

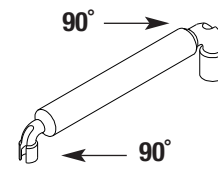

RPI Part #RPT296

OEM Part # (No OEM Part # Available)

UNIVERSAL SLEEVE TOOL

- Use on 1/8" OD tubing and 1/4" OD tubing
- Use to install all 1/8" and 1/4" sleeve clamps and Uni-Clamps (RPI Part #'s ADC034 & ADC035)
- The tool provides 90° angles on both ends for ease of use
- ~5" lg.

Dental Equipment

Barbs, Clamps, Sleeves & Washers (continued)



THE RPI ADVANTAGE!

All parts are also included in the Control Block Kit (Major) - RPI Part #ADK241 See page 502

With the Kit, you can easily replace any of the Control Block parts, or completely rebuild the Control Block. Save money and time with the Kit!

RPI Part #ADB230
OEM Part #023.505.01

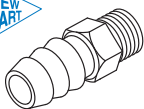

BARB

- 10 per package
- Material: Brass
- Size: 3/16" barb to #10-32 male thread
- Use with 3/16" ID x 5/16" OD tubing
- Also available: Washer (RPI Part #ADW038)
- Also included in: Control Block Kit (Major) (RPI Part #ADK241)

Models: Handpiece Control Bock 300 Series (OEM Part #38.1831.00) & 500 Series (OEM Part #38.1776.00)

RPI Part #ADB231
OEM Part #023.811.00

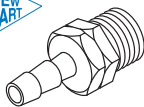

BARB (RESTRICTOR)

- 10 per package
- Material: Brass
- Size: 1/16" barb to #10-32 male thread
- .018" Orifice
- Use with 1/16" ID x 1/8" OD tubing
- Also available: Washer (RPI Part #ADW038)
- Also included in: Control Block Kit (Major) (RPI Part #ADK241)

Models: Handpiece Control Bock 300 Series (OEM Part #38.1831.00) & 500 Series (OEM Part #38.1776.00)

RPI Part #ADW038
OEM Part #004-005-00



FLAT WASHER

- 50 per package
- Material: Nylon®
- Size: .187" ID x .312" OD x .031" thk
- Fits: #10-32 male thread port

RPI Part #ADW039
OEM Part #004-036-00



FLAT WASHER

- 15 per package
- Material: Nylon®
- Size: .140" ID x .320" OD x .06" thk
- Fits: #6-32 male thread port

RPI Part #ADB249
OEM Part #026.175.01

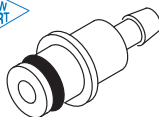

QUICK DISCONNECT BARB

- 5 per package
- Material: Brass
- Use with 1/8" ID x 3/16" OD silicone hand-piece tubing only
- Includes: O-Ring (RPI Part #RPO307)
- Also included in: Control Block Kit (Major) (RPI Part #ADK241)

Models: Handpiece Control Bock 300 Series (OEM Part #38.1831.00) & 500 Series (OEM Part #38.1776.00)

RPI Part #ADB250
OEM Part #026.161.00

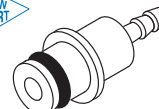

QUICK DISCONNECT BARB

- 5 per package
- Material: Brass
- Use with 1/16" ID x 1/8" OD vinyl hand-piece tubing only
- Includes: O-Ring (RPI Part #RPO307)
- Also included in: Control Block Kit (Major) (RPI Part #ADK241)

Models: Handpiece Control Bock 300 Series (OEM Part #38.1831.00) & 500 Series (OEM Part #38.1776.00)

RPI Part #ADB248
OEM Part #026.174.01

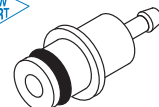

QUICK DISCONNECT BARB

- 5 per package
- Material: Brass
- Use with 1/16" ID X 1/8" OD silicone handpiece tubing only
- Includes: O-Ring (RPI Part #RPO307)
- Also included in: Control Block Kit (Major) (RPI Part #ADK241)

Models: Handpiece Control Bock 300 Series (OEM Part 38.1831.00) & 500 Series (OEM Part 38.1776.00)

RPI Part #ADB251
OEM Part #026.088.00

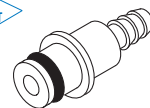

QUICK DISCONNECT BARB

- 5 per package
- Material: Brass
- Use with 1/8" ID x 1/4" OD vinyl handpiece tubing only
- Includes: O-Ring (RPI Part #RPO307)
- Also included in: Control Block Kit (Major) (RPI Part #ADK241)

Models: Handpiece Control Bock 300 Series (OEM Part 38.1831.00) & 500 Series (OEM Part 38.1776.00)

RPI Part #ADP232
OEM Part #026.160.01

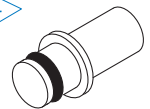

QUICK DISCONNECT PLUG

- 5 per package
- Material: Brass
- Includes: O-Ring (RPI Part #RPO307)
- Included in Control Block Kit (Major) (RPI Part #ADK241)

Models: Handpiece Control Bock 300 Series (OEM Part 38.1831.00) & 500 Series (OEM Part 38.1776.00)

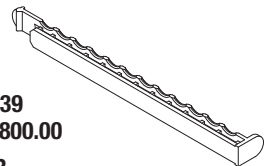

RPI Part #ADR239
OEM Part #38.1800.00

BARB RETAINER

- Included in Control Block Kit (Major) (RPI Part #ADK241) & Control Block Kit (Minor) (RPI Part #ADK257)

Models: Handpiece Control Bock 500 Series (OEM Part 38.1776.00)

RPI Part #ADW107
OEM Part #004-057-00



FLAT WASHER

- 6 per package
- Material: Brass
- Size: .185" ID x .371" OD

RPI Part #ADW186
OEM Part #004-078-00



FLAT WASHER

- 5 per package
- Material: Plastic
- Size: .090" ID x .190" OD x .020" thk

RPI Part #ADC065
OEM Part #025-021-00

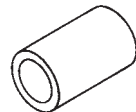

SLEEVE CLAMP

- 5 per package
- Material: Chrome plated brass
- Size: 9/64" ID

RPI Part #ADC063
OEM Part #021-034-00

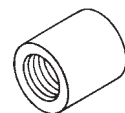

COUPLING

- 4 per package
- Material: Brass
- #10-32 Female

RPI Part ADS032
OEM Part #022-005-00



SLEEVE/FERRULE

- 25 per package
- Material: 1/4" Poly-Flo white plastic
- For 1/4" OD tubing

RPI Part #ADD020
OEM Part #22-0774-00

DIAPHRAGM

- 6 per package
 - Material: Fairprene
 - Size: .593" x .875"
- Fits:** Handpiece Control Valve

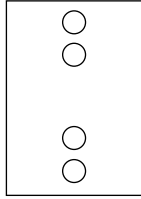

RPI Part #ADG124
OEM Part #29-0220-00

AUTO BLOCK GASKET (RED)

- 3 per package
 - Material: Polyester
 - Size: 1.015" x 1.015"
 - For lubricated drive air only
- Fits:** Handpiece Control Block Auto Block & Auto Pac

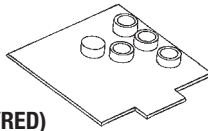

RPI Part #ADD023
OEM Part #38-0120-00

DIAPHRAGM

- 6 per package
 - Material: Fairprene
 - Size: 1.231" x 2.376"
- Fits:** Handpiece Control Block Century Pac

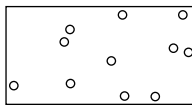

RPI Part #ADG029
OEM Part #35-0574-00

GASKET (MANIFOLD TUBING CONNECTOR)

- 3 per package
 - Material: Polyester
 - Size: .780" x 1.325"
- Fits:** Multi-Ported Tubing Manifold



RPI Part #ADD025
OEM Part #97-0200-00

DIAPHRAGM

- Material: Brass and neoprene
- Fits:** Air and Water Filter Regulator (OEM Part #40-0654-00)

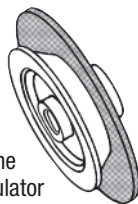

RPI Part #ADG158
OEM Part #38-0550-00

RED GASKET

- 5 per package
 - Size: .983" x 1.623"
 - Use only with the scaler block option - use Clear Gasket (RPI Part #ADG159) in all other positions
- Model:** Handpiece Control Block Century Plus (OEM Part #38.0540.00)

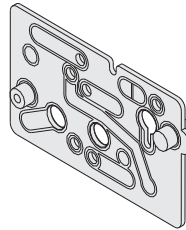

RPI Part #ADG159
OEM Part #38-0507-00

CLEAR GASKET

- 10 per package
 - Size: .983" x 1.623"
 - Use in all positions - use Red Gasket (RPI Part #ADG158) for scaler option
- Model:** Handpiece Control Block Century Plus (OEM Part #38.0540.00)

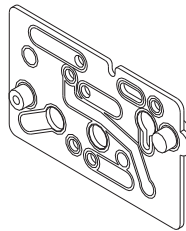

RPI Part #ADD160
OEM Part #38-0519-01

DIAPHRAGM

- 10 per package
 - Material: Fairprene
 - Size: ~.745" x 1.659"
- Model:** Handpiece Control Block Century Plus (OEM Part #38.0540.00)

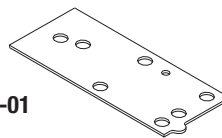

RPI Part #ADD238
OEM Part #38.1787.01

DIAPHRAGM

- 5 per package
 - Material: Fairprene
 - Size: 2.040" x 4.650"
- Model:** Handpiece Control Block 500 Series (OEM Part #38.1776.00)

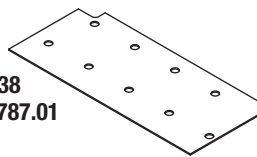

RPI Part #ADD024
OEM Part #38-0179-00

DIAPHRAGM

- 6 per package
 - Material: Fairprene
 - Size: .765" x 1.031"
- Model:** Handpiece Control Block Century II (OEM Part #38.0223.00)

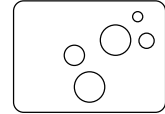

RPI Part #ADG031
OEM Part #38-0186-00

GASKET

- 6 per package
 - Material: Polyester
 - Size: .980" x 1.210"
- Model:** Handpiece Control Block Century II (OEM Part #38.0223.00)

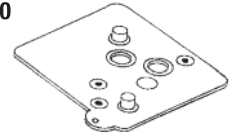

RPI Part #ADD022
OEM Part #38-0054-00

DIAPHRAGM

- 6 per package
 - Material: Fairprene
 - Size: .750" x .750"
- Models:** Handpiece Control Block Century II (OEM Part #38.0223.00); Foot Control 300 Series (OEM Part #38.1821.00), Foot Control 500 Series (OEM Part #38.1805.00), Foot Control (OEM Part #38-0050-00), Foot Control II (OEM Part #38-0254-00), Foot Control III (OEM Part #38.1601.00, 38.1603.00 & 381700.00), Foot Control Lever Action (OEM Part #38-0200-00); Water Coolant Relay Assembly 500 Series (OEM Part #38.1810.00); and Tooth Dryer Manifold

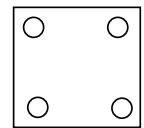

RPI Part #ADG027
OEM Part #24-0136-00

5 HOLE GASKET

- 6 per package
 - Material: Fairprene
 - Size: 1.000" x 1.000"
- Models:** Air Regulator Valve "White" Bodies (OEM Part #24-0135-00)

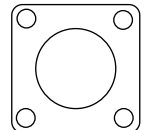

RPI Part #ADG028
OEM Part #24-0137-00

9 HOLE GASKET

- 6 per package
 - Material: Fairprene
 - Size: 1.030" x 1.030"
- Models:** Air Regulator Valve "White" Bodies (OEM Part #24-0135-00) & Water Regulator Valve "Black" Bodies (OEM Part #24-0355-00)

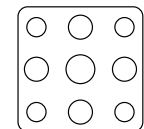

RPI Part #ADD019
OEM Part #22-0440-00

DIAPHRAGM

- 6 per package
 - Material: Fairprene
 - Size: 1.000" x 1.000"
- Models:** Air Regulator Valve "White" Bodies (OEM Part #24-0135-00) & Water Regulator Valve "Black" Bodies (OEM Part #24-0355-00)

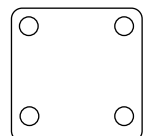

RPI Part #RPD114
OEM Part # (No OEM Part # Available)

GASKET/DIAPHRAGM SHEET MATERIAL

- Material: Fairprene
- Size: 12" x 12" x .015"
- Use for customizing gaskets and diaphragms

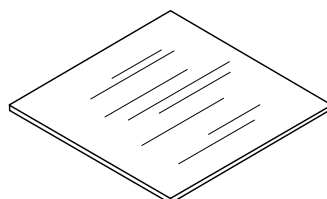

Dental Equipment

Cartridges, Pistons, Poppets & Stems

RPI Part #ADS123
OEM Part #29-0831-00

VALVE STEM (NEW STYLE)

- 2 per package
- **For non-retraction**
- Material: Plated brass
- Includes: (2 pcs) O-Ring (RPI Part #RPO309)

Model: Handpiece Control Block Century II (OEM Part #38.0223.00)

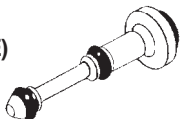

RPI Part #ADS005
OEM Part #29-0835-00

VALVE STEM

- 3 per package
- **For retraction**
- Material: Plated brass
- Includes: (1 pc) O-Ring (RPI Part #RPO309)

Model: Handpiece Control Block Century II (OEM Part #38.0223.00)

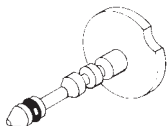

RPI Part #ADS007
OEM Part #33-0103-00

VALVE STEM NEEDLE

- Material: Plated brass
- Includes: (1 pc) O-Ring (RPI Part #RPO312)

Model: Handpiece Control Block Century II (OEM Part #38.0223.00)

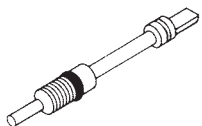

RPI Part #ADS077
OEM Part #33-0117-00

NEEDLE VALVE STEM

- Material: Plated brass
- Includes: (1 pc each) O-Ring (RPI Part #RPO307), and Retaining Ring (RPI Part #ADRO40)

Fits: Needle Cartridge Valve (Newer style)

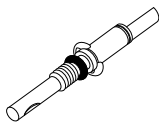

RPI Part #ADS055
OEM Part #29-0100-00

ADJUSTING SCREW

- 3 per package
- **For non-retraction with HPCB Century II**
- 10-32 x 5/8"
- Material: Plated brass
- Includes: (1 pc) O-Ring (RPI Part #RPO312)

Model: Handpiece Control Block Century II (OEM Part #38.0223.00), Century II Master Block, Auto-Block and Pac Control System

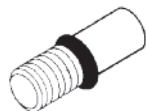

RPI Part #ADS168
OEM Part #38.0510.00

STEM (DRIVE AIR ADJ.)

- 3 per package
- Material: Nickel plated brass
- Includes: (1 pc) O-Ring (RPI Part #RP0752)

Model: Handpiece Control Block Century Plus (OEM Part #38.0540.00)



RPI Part #ADV161
OEM Part #38-0518-00

CARTRIDGE (CHECK VALVE)

- 3 per package
- Material: Brass cartridge (Blue top) and rubber duckbill with O-Ring

Model: Handpiece Control Block Century Plus (OEM Part #38.0540.00)



RPI Part #ADV163
OEM Part #38-0520-00

CARTRIDGE (WATER VALVE)

- 3 per package
- Material: Brass cartridge (Red top) and O-Rings

Model: Handpiece Control Block Century Plus (OEM Part #38.0540.00)



RPI Part #ADV162
OEM Part #38-0517-00

CARTRIDGE (AIR BLEED VALVE)

- 3 per package
- Material: Brass cartridge (Brass top) with O-Rings

Model: Handpiece Control Block Century Plus (OEM Part #38.0540.00)



RPI Part #ADP188
OEM Part #38.0646.00 & 38.0648.00 (Kit)

PLUG (CHECK VALVE)

- 3 per package
- Material: Brass cartridge (Black top); Replaces Cartridge (Check Valve) (RPI Part #ADV161)

Model: Handpiece Control Block Century Plus (OEM Part #38.0540.00)

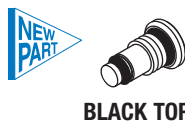

RPI Part #ADP189
OEM Part #38.0647.00 & 38.0648.00 (Kit)

PLUG (WATER VALVE)

- 3 per package
- Material: Brass cartridge (Black top); Replaces Cartridge (Water Valve) (RPI Part #ADV163)

Model: Handpiece Control Block Century Plus (OEM Part #38.0540.00)

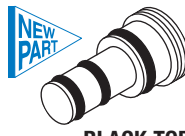

RPI Part #RPL090
OEM Part #98.0090.01

HIGH TEMP LUBRICANT

- 5 per package; 1/2 gram per unit
- **For Non-silicone use only. Do not use with highly oxidative chemicals (e.g. liquid chlorine, liquid oxygen, etc.).**
- Temperature range: -40°F to +400°F (-40°C to +204°C)

RPI Part #ADC236
OEM Part #38.1780.00

WATER CARTRIDGE ASSEMBLY

- For a wet block position
- Material: Brass
- Includes: Retaining Ring (RPI Part #ADR240), O-Ring (RPI Part #RPO312) & (3) O-Ring (RPI Part #RPO303)

Models: Handpiece Control Block 300 Series (OEM Part #38.1831.00) & 500 Series (OEM Part #38.1776.00)

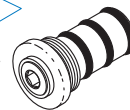

RPI Part #ADC237
OEM Part #38.1783.00

WATER CARTRIDGE ASSY DRY

- For a dry block position
- Material: Brass
- Includes: Retaining Ring (RPI Part #ADR240) & (2) O-Ring (RPI Part #RPO303)

Models: Handpiece Control Block 300 Series (OEM Part #38.1831.00) & 500 Series (OEM Part #38.1776.00)

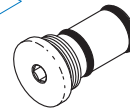

RPI Part #ADS235
OEM Part #38.1785.01

STEM (DRIVE AIR)

- Material: Nickel plated brass
- Includes: (1 pc) O-Ring (RPI Part #RP0752)

Models: Handpiece Control Block 300 Series (OEM Part #38.1831.00) & 500 Series (OEM Part #38.1776.00)

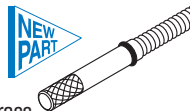

RPI Part #ADT242
OEM Part #38.1808.01/98.0867.02

STEM ADJUSTMENT TOOL

- 5 per package
- Material: Stainless steel
- Includes: (1 pc) O-Ring (RPI Part #RP0486)
- Can be used in place of either Handpiece Control Adjustment Keys (OEM Part #98.0867.02) or Flow Adjustment Keys (OEM Part #38.1808.01)

Model: Handpiece Control Block 500 Series (OEM Part #38.1776.00) and Century Plus (OEM Part #38.0540.00)

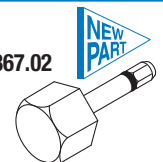

RPI Part #ADS233
OEM Part #38.0516.00

STEM (WATER FLOW ADJ.)

- Material: Nickel plated brass
- .125" hex socket
- Includes: O-Ring (RPI Part #RP0752)

Model: Handpiece Control Block 500 Series (OEM Part #38.1776.00) and Century Plus (OEM Part #38.0540.00)

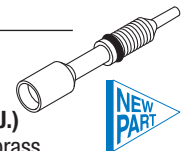

RPI Part #ADS234
OEM Part #38.0526.00

STEM (AIR COOLANT)

- Material: Nickel plated brass
- .125" hex socket
- Includes: O-Ring (RPI Part #RP0484)

Model: Handpiece Control Block 500 Series (OEM Part #38.1776.00)

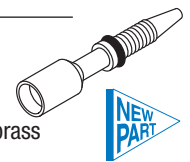

RPI Part #ADC098
OEM Part #38-0106-00

VALVE END CAP

- Material: Brass
- Includes: (1 pc) O-Ring (RPI Part #RPO305)

Model: Handpiece Control Block Cenutry Water Valve Assembly (OEM Part #38.0098.00)



RPI Part #ADP099
OEM Part #38-0104-00

PISTON

- Material: Brass
- Includes: (2 pcs) O-Rings (RPI Part #RPO305)

Model: Handpiece Control Block Cenutry Water Valve Assembly (OEM Part #38.0098.00)



RPI Part #ADS010
OEM Part #38-0102-00

VALVE STEM NEEDLE (BLACK)

- Material: Plastic
- Includes: (1 pc) O-Ring (RPI Part #RPO305)

Model: Handpiece Control Block Cenutry Water Valve Assembly (OEM Part #38.0098.00)

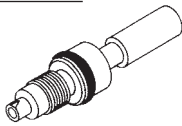

RPI Part #ADP068
OEM Part #97-0240-00

POPPET

- Material: Brass with rubber seat
- Models:** Air Filter Regulator (OEM Part #026-021-01) & Water Filter Regulator (OEM Part #40-0654-00)

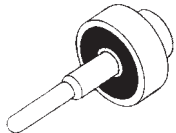

RPI Part #ADP157
OEM Part #24-0132-00

PISTON WITH O-RING

- 5 per package;
- Material: White plastic
- Includes: with (1 pc) O-Ring (RPI Part #RPO311)

Models: Air Regulator Valve "White" Bodies (OEM Part #24-0135-00) & Water Regulator Valve "Black" Bodies (OEM Part #24-0355-00)

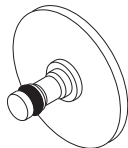

RPI Part #ADS106
OEM Part #38-0211-00

VALVE STEM

- Material: Brass with plastic seat
- Models:** Foot Control Lever Action (OEM Part #38-0200-00)

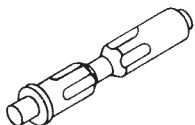

RPI Part #ADS087
OEM Part #22-0778-00

RELAY VALVE STEM

- 5 per package
- Material: Brass
- Includes: (2 pcs) O-Ring (RPI Part #RPO309)

Models: Foot Control (OEM Part #38-0050-00), Foot Control II (OEM Part #38-0254-00), Foot Control III (OEM Part #'s 38.1601.00, 38.1603.00 & 38.1700.00), Foot Control 300 Series (OEM Part #38.1821.00), Foot Control 500 Series (OEM Part #38.1805.00) Foot Control Lever Action (OEM Part #38-0200-00) & Water Coolant Relay Assembly 500 Series (OEM Part #38.1810.00)



RPI Part #ADS090
OEM Part #38-0246-00

FOOT CONTROL STEM

- Material: Brass
- Includes: (1 pc) Retaining Ring (RPI Part #ADRO40)

Model: Foot Control II (OEM Part #38-0254-00)

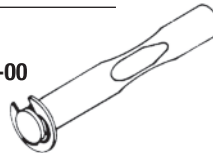

RPI Part #ADP243
OEM Part #38.0760.00



PISTON (FOOT CONTROL III)

- Material: Delrin
 - Includes: (1 pc) Cup Seal (RPI Part #RPS748)
- Models:** Foot Control III (OEM Part #'s 38.1601.00, 38.1603.00, & 38.1700.00), Foot Control 300 Series (OEM Part #38.1821.00) & Foot Control 500 Series (OEM Part #38.1805.00)

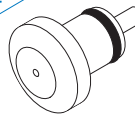

RPI Part #ADP083
OEM Part #22-0060-00

POPPET

- 10 per package
- Material: Plastic

Models: Foot Control III (OEM Part #'s 38.1601.00, 38.1603.00, & 38.1700.00), Foot Control (OEM Part #38-0050-00), Foot Control 300 Series (OEM Part #38.1821.00) & Foot Control 500 Series (OEM Part #38.1805.00)



RPI Part #ADC255
OEM Part #38.0066.00



SPRING CAP (WET/DRY VALVE)

- Material: Nylon®
- Models:** Foot Control (OEM Part #38-0050-00), Foot Control II (OEM Part #38-0254-00), Foot Control III (OEM Part #'s 38.1601.00, 38.1603.00 & 38.1700.00), Foot Control 300 Series (OEM Part #38.1821.00), Foot Control 500 Series (OEM Part #38.1805.00) Foot Control Lever Action (OEM Part #38-0200-00)



RPI Part #ADP084
OEM Part #22-0083-00

PISTON

- Material: Brass
 - Includes: (2 pcs) O-Rings (RPI Part #RPO302) and set screw
- Models:** Foot Control (OEM Part #38-0050-00)

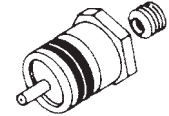

RPI Part #ADS004
OEM Part #29-0830-00

VALVE STEM (2-WAY)

- 2 per package
 - Material: Plated brass
 - Includes: (2 pcs) O-Rings (RPI Part #RPO309)
- Models:** Coolant Water Valve (OEM Part #22-0790-00 & 22-0960-00), 2-Way Toggle Valves & 2-Way Push Button Valve

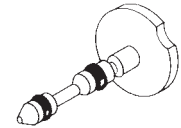

RPI Part #ADS093
OEM Part #22-0999-00

VALVE STEM

- Material: Brass
 - Includes: (2 pcs) O-Ring (RPI Part #RPO309)
- Model:** Coolant Water Valve (OEM Part #22-0790-00 & 22-0960-00)



RPI Part #ADS100
OEM Part #29-0972-00

VALVE STEM

- 3 per package
 - Material: Brass
 - Includes: (1 pc) O-Ring (RPI Part #RPO319)
- Model:** Coolant Water Valve (OEM Part #22-0790-00 & 22-0960-00)

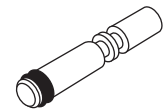

RPI Part #ADS101
OEM Part #22-0776-00

VALVE STEM

- 2 per package
 - Material: Brass
 - Includes: (1 pc) Quad Ring (RPI Part #RPO319)
- Model:** Coolant Water Valve (OEM Part #22-0790-00 & 22-0960-00)

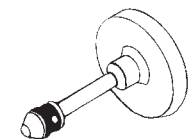

RPI Part #ADS092
OEM Part #30-0731-00

SHUT-OFF VALVE STEM

- Material: Brass
 - Includes: (2 pcs) O-Ring (RPI Part #RPO307)
 - #6-32 thread
- Fits:** Air-Operated Shut-Off Valve

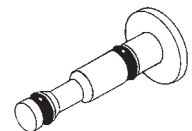

Dental Equipment

Cartridges, Pistons, Poppets & Stems (continued)

RPI Part #ADS008
OEM Part #33-0106-00

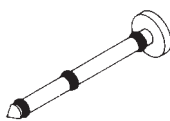

VALVE STEM

- Material: Brass
- Includes: (3 pcs) O-Rings (RPI Part #RPO309)
- Fits:** Micro-Selector Valve

RPI Part #ADS009
OEM Part #38-0087-00



VALVE STEM

- 2 per package
- Material: Brass
- Includes: (2 pcs) O-Ring (RPI Part #RPO309)
- Fits:** Balanced 2-Way Micro-Valve (OEM Part #38-0086-00)

RPI Part #ADS002
OEM Part #29-0810-00

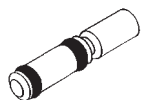

VALVE STEM

- 3 per package
- Material: Brass
- Includes: (2 pcs) O-Rings (RPI Part #RPO309)
- Fits:** 2-Way Micro-Valve (OEM Part #38-0062-00)

RPI Part #ADS059
OEM Part #40-0722-00

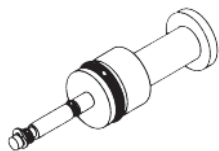

VACUUM VALVE STEM

- Material: Plated brass
- Includes: (1 pc each) O-Rings (RPI Part #RPO302, RPO310, RPO311), and Retaining Ring (RPI Part #ADR043)
- Fits:** Vacuum Drain Actuator (OEM Part #40-0742-00) & Vacuum Sink Assembly (OEM Part #40-0200-00)

RPI Part #ADS006
OEM Part #29-0840-00

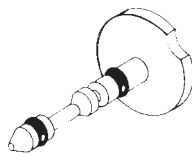

VALVE STEM (3-WAY)

- 3 per package
- Material: Plated brass
- Includes: (2 pcs) O-Rings (RPI Part #RPO309)
- Fits:** 3-Way Toggle Valve and Cartridge Valve

RPI Part #ADS003
OEM Part #29-0820-00

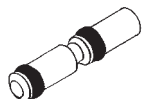

VALVE STEM

- 3 per package
- Material: Brass
- Includes: (2 pcs) O-Rings (RPI Part #RPO309)
- Fits:** 3-Way Micro-Valve (OEM Part #29-0185-00)

RPI Part #ADB070
OEM Part #10-0110-00

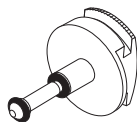

LOCKING BUTTON ASSEMBLY

- Material: Plated brass
- Includes: (2 pcs) O-Ring (RPI Part #RPO309)
- Fits:** AVS Air Supply Tubing with Handpiece

RPI Part #ADP044
OEM Part #34-0003-00



VACUUM VALVE POPPET

- Material: Brass
- Includes: (1 pc) O-Ring (RPI Part #RPO305)
- Fits:** Vacuum Drain Actuator (OEM Part #40-0742-00) & Vacuum Sink Assembly (OEM Part #40-0200-00)

NOTES: _____

RPI Part #RPL090
OEM Part #98.0090.01

HIGH TEMP LUBRICANT

- 5 per package; 1/2 gram per unit
- **For Non-silicone use only.** Do not use with highly oxidative chemicals (e.g. liquid chlorine, liquid oxygen, etc.).
- Temperature range: -40°F to +400°F (-40°C to +204°C)

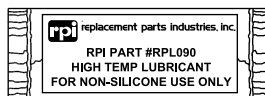

RPI PART #RPK403

OEM Part # (No OEM Part # Available)

O-RING KIT

- Kit includes 8-compartment storage case (RPI Part #RPB414)
- O-Rings are also sold separately in quantities indicated below

RPI PART #	OEM PART #	X-SEC	ID	OD	IND PART #	MATERIAL	DURO	QTY
RPO301	No OEM # Available	.070	.489	.629	AS568-014	Nitrile (Buna N)	70	12
RPO302	030-013-00	.070	.426	.566	AS568-013	Nitrile (Buna N)	70	12
RPO303	030-012-00 & 030.012.01	.070	.364	.504	AS568-012	Nitrile (Buna N)	70	12
RPO304	030-011-00	.070	.301	.441	AS568-011	Nitrile (Buna N)	70	12
RPO305	030-010-00 & 030-010-02	.070	.239	.379	AS568-010	Nitrile (Buna N)	70	12
RPO306	No OEM # Available	.070	.176	.316	AS568-008	EPDM	70	12
RPO307	035 048 01*	.070	.114	.254	AS568-006	EPDM	70	12
RPO308	No OEM # Available	.040	.070	.150	5-051	Nitrile (Buna N)	70	12

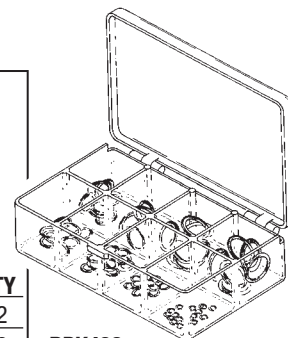

RPK403
O-RING KIT

* O-RING (RPI PART #RPO307) ALSO REFERS TO OEM PART# 030-006-02 Material: Nitrile (Buna N)

RPI PART #RPK404

OEM Part # (No OEM Part # Available)

O-RING KIT

- Kit includes 18-compartment storage case (RPI Part #RPB414)
- O-Rings are also sold separately in quantities indicated below

RPI PART #	OEM PART #	X-SEC	ID	OD	IND PART #	MATERIAL	DURO	QTY
RPO301	No OEM # Available	.070	.489	.629	AS568-014	Nitrile (Buna N)	70	12
RPO302	030-013-00	.070	.426	.566	AS568-013	Nitrile (Buna N)	70	12
RPO303	030-012-00 & 030.012.01	.070	.364	.504	AS568-012	Nitrile (Buna N)	70	12
RPO304	030-011-00	.070	.301	.441	AS568-011	Nitrile (Buna N)	70	12
RPO305	030-010-00 & 030-010-02	.070	.239	.379	AS568-010	Nitrile (Buna N)	70	12
RPO306	No OEM # Available	.070	.176	.316	AS568-008	EPDM	70	12
RPO307	035 048 01*	.070	.114	.254	AS568-006	EPDM	70	12
RPO308	No OEM # Available	.040	.070	.150	5-051	Nitrile (Buna N)	70	12
RPO309	030-001-00	.040	.029	.109	AS568-001	Nitrile (Buna N)	70	12
RPO310	030-002-00	.050	.042	.142	AS568-002	Nitrile (Buna N)	70	12
RPO311	030-003-00	.060	.056	.176	AS568-003	Nitrile (Buna N)	70	12
RPO312	030-004-00	.070	.070	.210	AS568-004	Nitrile (Buna N)	70	12
RPO313	030-005-00	.070	.101	.241	AS568-005	Nitrile (Buna N)	70	12
RPO314	No OEM # Available	.070	.145	.285	AS568-007	Nitrile (Buna N)	70	12
RPO315	030-009-00	.070	.208	.348	AS568-009	Nitrile (Buna N)	70	12
RPO316	030-015-00	.070	.551	.691	AS568-015	Nitrile (Buna N)	70	12
RPO317	030-016-00 & 030-016-02	.070	.614	.754	AS568-016	Nitrile (Buna N)	70	12
RPO318	033-006-00	.070	.676	.816	AS568-017	Nitrile (Buna N)	70	12

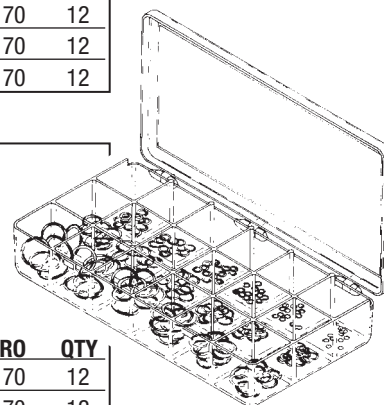

RPK404
O-RING KIT

RPI Part #RPL090
OEM Part #98.0090.01

HIGH TEMP LUBRICANT

- 5 per package
- 1/2 gram per unit

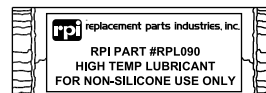

* O-RING (RPI PART #RPO307) ALSO REFERS TO OEM PART# 030-006-02 Material: Nitrile (Buna N)

RPI Part #RPK481 OEM Part # 009-013-00

O-RING INSTALLATION TOOLS

- Three sizes
- Accommodates O-Rings with ID of .029" through .208"
- Stainless steel
- ~1-3/4" lg.

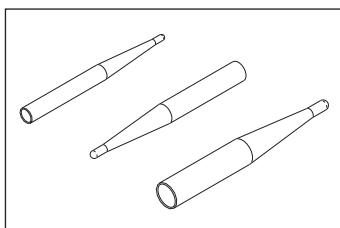

RPI Part #RPK581 OEM Part # (No OEM Part # Available)

O-RING REMOVAL TOOLS

- Pointed ends for hard to reach areas
- Blunt edges for larger surfaces
- Brass (to reduce potential o-ring groove damage)
- ~5-1/2" lg.

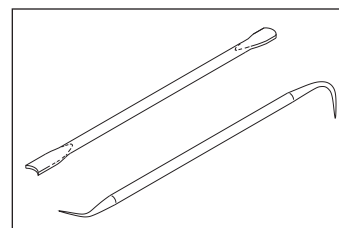

Dental Equipment

O-Rings, O-Ring Kits & Lubricant (continued)

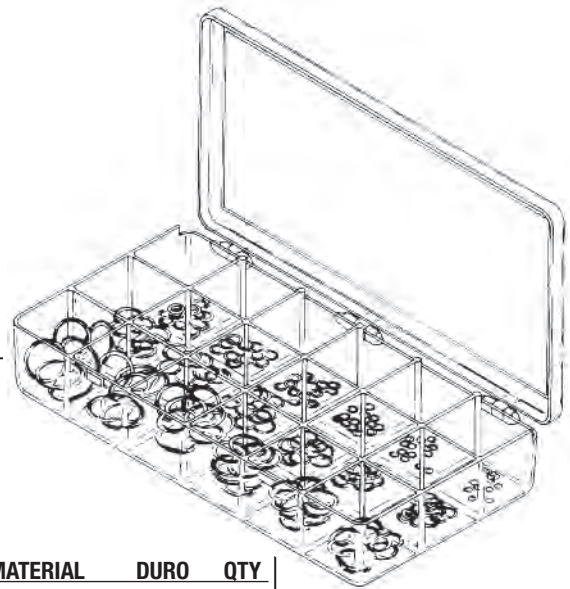

**RPK483
AUTOCLAVEABLE
O-RING KIT**

RPI PART #RPK483

OEM Part # (No OEM Part # Available)

AUTOCLAVEABLE O-RING KIT

- Kit includes 18-Compartment Storage Case (RPI Part #RPB417)
- O-Rings are also sold separately in quantities indicated below

RPI PART #	OEM PART #	X-SEC	ID	OD	IND PART #	MATERIAL	DURO	QTY
RPO307	035 048 01*	.070	.114	.254	AS568-006	EPDM	70	12
RPO326	033 014 01 & 033-014-00	.070	.489	.629	AS568-014	Viton	75	12
RPO444	034 019 01	.070	.801	.941	AS568-019	EPDM	70	12
RPO484	033.003.01	.060	.056	.176	AS568-003	Viton	75	12
RPO485	034 013 01, 030-013-01 & 030-013-02	.070	.426	.566	AS568-013	EPDM	70	12
RPO486	034.002.01	.050	.042	.142	AS568-002	EPDM	70	12
RPO487	034 003 01	.060	.056	.176	AS568-003	EPDM	70	12
RPO488	034-014-01 & 034-014-02	.070	.489	.629	AS568-014	EPDM	70	12
RPO489	035 033 01	.070	.101	.241	AS568-005	EPDM	70	12
RPO490	034 018 02	.070	.739	.879	AS568-018	EPDM	70	12
RPO491	034-107-00 & 034-107-01	.103	.206	.412	AS568-107	EPDM	70	12
RPO492	035 029 01	.070	.208	.348	AS568-009	Silicone	70	12
RPO493	034 001 00	.038	.032	.108	Custom	EPDM	70	12
RPO494	035 049 01	.040	.176	.256	Custom	EPDM	70	12
RPO495	035 009 01	.062	.400	.520	Custom	Viton	75	12
RPO496	035 050 01	.040	.070	.150	Custom	EPDM	70	12
RPO497	035 030 01	.040	.176	.256	Custom	Viton	75	12
RPO498	034-012-01	.070	.364	.504	AS568-012	EPDM	70	12

* O-RING (RPI PART #RPO307) ALSO REFERS TO OEM PART# 030-006-02 Material: Nitrile (Buna N)

**RPI Part #RPK481
OEM Part # 009-013-00**

O-RING INSTALLATION TOOLS

- Three sizes
- Accommodates O-Rings with ID of .029" through .208"
- Stainless steel
- ~1-3/4" lg.

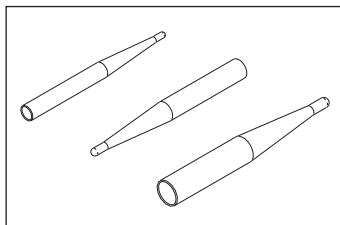

**RPI Part #RPK581
OEM Part # (No OEM Part # Available)**

O-RING REMOVAL TOOLS

- Pointed ends for hard to reach areas
- Blunt edges for larger surfaces
- Brass (to reduce potential o-ring groove damage)
- ~5-1/2" lg.

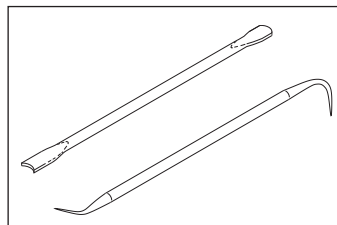

**RPI Part #RPL090
OEM Part #98.0090.01**

HIGH TEMP LUBRICANT

- 5 per package; 1/2 gram per unit
- **For Non-silicone use only. Do not use with highly oxidative chemicals (e.g. liquid chlorine, liquid oxygen, etc.).**
- Temperature range: -40°F to +400°F (-40°C to +204°C)

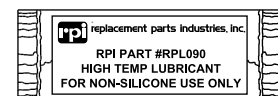

RPI Part #RP0319
OEM Part #035-003-00
Industry Part #Q4001

QUAD RING

- 12 per package
- Buna-N (Nitrile), 70 Duro
- .028" ID x .110" OD x .041" C/S



RPI Part #RP0752
OEM Part #035.034.01

O-RING

- 12 per package
- Material: Nitrile (Buna N); 70 Duro
- Size: .098" ID x .177" OD x .039" C/S
- Fits:** Drive Air Stem (RPI Part #ADS235)



RPI Part #RP0327
OEM Part #035-019-00
Industry Part #AS568-008

O-RING

- 12 per package
- Natural Silicone, 70 Duro
- .176" ID x .316" OD x .070" C/S



RPI Part #RP0325
OEM Part #030-019-00
Industry Part #AS568-019

O-RING

- 12 per package
- Buna-N (Nitrile), 70 Duro
- .801" ID x .941" OD x .070" C/S

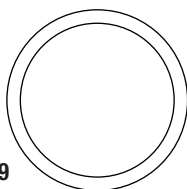

RPI Part #RP0322
OEM Part #030-023-02
Industry Part #AS568-023

O-RING

- 12 per package
- Buna-N (Nitrile), 70 Duro
- 1.051" ID x 1.191" OD x .070" C/S

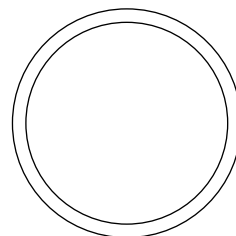

RPI Part #RP0321
OEM Part #030-034-02
Industry Part #AS568-034

O-RING

- 12 per package
- Buna-N (Nitrile), 70 Duro
- 2.114" ID x 2.254" OD x .070" C/S

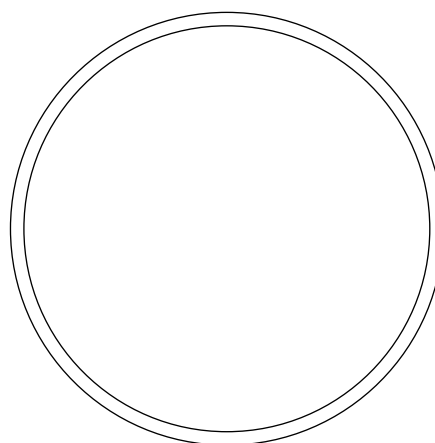

O-Ring illustrations are actual size

RPI Part #RPK481
OEM Part # 009-013-00

O-RING INSTALLATION TOOLS

- Three sizes
- Accommodates O-Rings with ID of .029" through .208"
- Stainless steel
- ~1-3/4" lg.

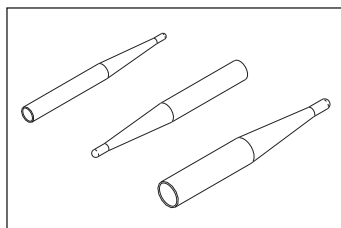

RPI Part #RPK581
OEM Part # (No OEM Part # Available)

O-RING REMOVAL TOOLS

- Pointed ends for hard to reach areas
- Blunt edges for larger surfaces
- Brass (to reduce potential o-ring groove damage)
- ~5-1/2" lg.

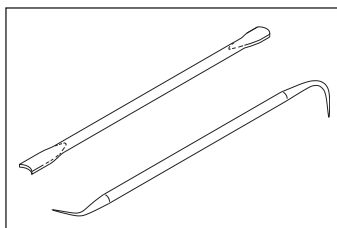

RPI Part #RPL090
OEM Part #98.0090.01

HIGH TEMP LUBRICANT

- 5 per package; 1/2 gram per unit
- **For Non-silicone use only.** Do not use with highly oxidative chemicals (e.g. liquid chlorine, liquid oxygen, etc.).
- Temperature range: -40°F to +400°F (-40°C to +204°C)



Dental Equipment

Screws & Screw Kits

**Perfect Kit when servicing
components of Dental Delivery
Systems & Units**

**RPI PART #ADK110
SOCKET HEAD CAP SCREW KIT**

- Kit includes 12-Compartment Storage Case (RPI Part #RPB416)
 - Hardware is also sold separately in quantities indicated below
- Fits:** Various components of A-dec dental delivery systems and units

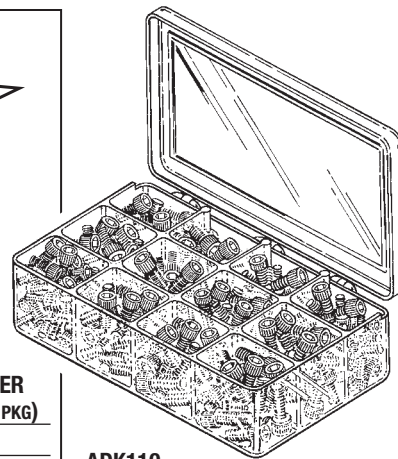

**ADK110
SOCKET HEAD CAP
SCREW KIT**

RPI PART #	OEM PART #	SIZE	MATERIAL	KIT QTY	REORDER QTY (PER PKG)
ADS053	001-034-00	#6-32 x 1/4" lg.	Stainless Steel	10	10
ADS111	001-033-00	#6-32 x 3/8" lg.	Stainless Steel	25	25
ADS112	001-042-00	#6-32 x 1/2" lg.	Stainless Steel	25	25
ADS113	001-010-00	#6-32 x 5/8" lg.	Stainless Steel	25	25
ADS114	001-026-00	#6-32 x 7/8" lg.	Stainless Steel	25	25
ADS115	002-011-00	#6-32 x 1" lg.	Stainless Steel	25	25
ADS116	003-078-00	#4-40 x 1/4" lg.	Stainless Steel	25	25
ADS117	001-024-00	#4-40 x 3/8" lg.	Stainless Steel	25	25
ADS118	001-021-00	#4-40 x 1/2" lg.	Stainless Steel	25	25
ADS119	002-024-00	#4-40 x 3/4" lg.	Stainless Steel	25	25
ADS120	001-070-00	#2-56 x 1/2" lg.	Stainless Steel	25	25
ADS121	001-089-00	1/4-20 x 5/8" lg.	Stainless Steel	15	15

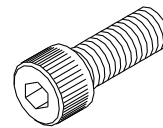

**SOCKET HEAD
CAP SCREW**

**RPI Part #RPT539
L-HEX WRENCH SET (METRIC)**

- 9 piece set
- 1.5 mm through 10 mm
- Corrosion protected steel
- Made by Bondhus®

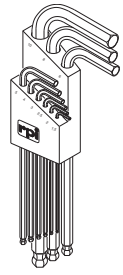

**RPI Part #RPT540
L-HEX WRENCH SET (INCH)**

- 13 piece set
- .050" through 3/8"
- Corrosion protected steel
- Made by Bondhus®

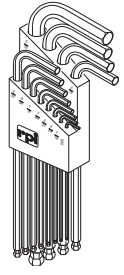

**RPI Part #RPA032
THREADLOCKER 242**

- 5 per package
- .02 fl. oz. per unit
- Prevents rust and corrosion
- Removable adhesive by Loctite®
- MSDS and Technical Data sheet available on RPI website

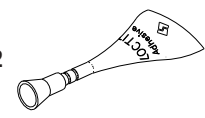

NOTES: _____



RPI Part #RPH743
OEM Part #003.031.00

PHILLIPS PAN HEAD SCREW #4

- 25 per package
 - Material: Zinc plated steel
 - Size: #4 Self Tapping Screw x 1/2" lg.
- Models:** Foot Control (OEM Part #38-0050-00), Foot Control II (OEM Part #38-0254-00), Foot Control III (OEM Part #'s 38.1601.00, 38.1603.00 & 38.1700.00), Foot Control 300 Series (OEM Part #38.1821.00), Foot Control 500 Series (OEM Part #38.1805.00) & Foot Control Lever Action (OEM Part #38-0200-00)



RPI Part #RPH742
OEM Part #003.0221.00

PHILLIPS PAN HEAD SCREW #6

- 25 per package
 - Material: Zinc plated steel
 - Size: #6 Self Tapping Screw x 1/2" lg.
- Models:** Foot Control (OEM Part #38-0050-00), Foot Control II (OEM Part #38-0254-00), Foot Control III (OEM Part #'s 38.1601.00, 38.1603.00 & 38.1700.00), Foot Control 300 Series (OEM Part #38.1821.00), Foot Control 500 Series (OEM Part #38.1805.00) & Foot Control Lever Action (OEM Part #38-0200-00)

RPI Part #ADS056
OEM Part #007-002-00 & 007.021.00



SOCKET HEAD SET SCREW

- 20 per package
 - Material: Stainless steel
 - Size: #6-32 x 3-16" lg.
- Models:** Foot Control (OEM Part #38-0050-00), Foot Control II (OEM Part #38-0254-00), Foot Control III (OEM Part #'s 38.1601.00, 38.1603.00 & 38.1700.00), Foot Control 300 Series (OEM Part #38.1821.00), Foot Control 500 Series (OEM Part #38.1805.00), Foot Control Lever Action (OEM Part #38-0200-00) & Trutorc & IC Handpiece Holders

RPI offers a wide selection of general shop aids including screws, nuts, bolts, washers, o-rings and more. Please see the General Shop Aids Section for details.

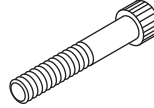

RPI Part #RPH741
OEM Part #001.102.00

SOCKET HEAD CAP SCREW

- 25 per package
 - Material: Stainless steel
 - Size: #4-40 x 7/8" lg.
- Models:** Foot Control (OEM Part #38-0050-00), Foot Control II (OEM Part #38-0254-00), Foot Control III (OEM Part #'s 38.1601.00, 38.1603.00 & 38.1700.00), Foot Control 300 Series (OEM Part #38.1821.00), Foot Control 500 Series (OEM Part #38.1805.00) & Foot Control Lever Action (OEM Part #38-0200-00)

RPI Part #ADS116
OEM Part #003-078-00



SOCKET HEAD CAP SCREW

- 25 per package
 - Material: Stainless steel
 - Size: #4-40 x 1/4" lg.
- Models:** Foot Control (OEM Part #38-0050-00), Foot Control II (OEM Part #38-0254-00), Foot Control III (OEM Part #'s 38.1601.00, 38.1603.00 & 38.1700.00), Foot Control 300 Series (OEM Part #38.1821.00), Foot Control 500 Series (OEM Part #38.1805.00) & Foot Control Lever Action (OEM Part #38-0200-00)

RPI Part #ADS054
OEM Part #001-073-00

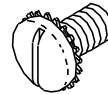

PAN HEAD SLOTTED SCREW

- 10 per package
 - Material: Stainless steel
 - Size: #6-32 x 1/4" lg.
- Fits:** End Cap, Excellence Arm Assembly & Flex Arm II

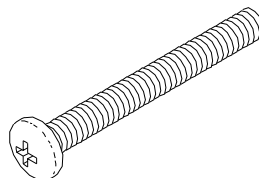

RPI Part #ADS109
OEM Part #001-023-00

PHILLIPS PAN HEAD MACHINE SCREW

- 25 per package
 - Material: Stainless steel
 - Size: #6-32 x 1-1/4" lg.
- Fits:** Vacuum Drain Actuator & Vacuum Sink Assembly



RPI Part #ADS169
OEM Part #002-118-00

BUTTON HEAD CAP SCREW

- 5 per package
 - Material: Stainless steel
 - Size: #4-40 x 3/16" lg.
- Can be used on all one piece hydraulic manifolds to retain flow adj. screws
- Model:** Handpiece Control Block Century Plus (OEM Part #38.0540.00)

RPI Part #ADS052
OEM Part #001-002-00

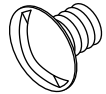

TRUSS HEAD SLOTTED SCREW

- 10 per package
 - Material: Stainless steel
 - Size: #2-56 x 1/8" lg.
- Models:** Handpiece Control Block Century II (OEM Part #38.0223.00), Handpiece Control Block Century Plus (OEM Part #38.0540.00), Handpiece Control Block Century Water Valve System (OEM Part #38.0098.00) & Tooth Dryer End Cap

RPI Part #ADS097
OEM Part #002-097-00

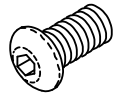

BUTTON HEAD SCREW

- 12 per package
 - Material: Stainless steel
 - Size: #4-40 x 1/4" lg.
- Model:** Handpiece Control Block Century II (OEM Part #38.0223.00)

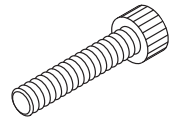

RPI Part #RPH740
OEM Part #001.240.00

SOCKET HEAD CAP SCREW

- 25 per package
 - Material: Stainless steel
 - Size: #6-32 x 3/4" lg.
- Models:** Handpiece Control Block 300 Series (OEM Part #38.1831.00) & 500 Series (OEM Part #38.1776.00)

RPI Part #ADS108
OEM Part #007-010-00



SOCKET HEAD SET SCREW

- 25 per package
 - Material: Stainless steel
 - Size: #4-40 x 1/8" lg.
- Model:** Handpiece Control Block Century Water Valve Assembly (OEM Part #38.0098.00)

Dental Equipment

Saliva Ejector Tips

RPI Part #ADT151
OEM Part #12-0183-01

SALIVA EJECTOR TIP (GRAY)

- 2 per package
- Medical Grade Silicone; Autoclaveable
- Color: Gray; Push-On Type

Fits: All Saliva Ejector Valves (Push On Type)



RPI Part #ADT060
OEM Part #12-0183-00

SALIVA EJECTOR TIP (BLACK)

- 2 per package
- Medical Grade Silicone; Autoclaveable
- Color: Black; Push-On Type

Fits: All Saliva Ejector Valves (Push On Type)



Vacuum Systems Parts & Kit

RPI Part #ADK033
OEM Part #90-0319-00

VACUUM DRAIN KNOB SERVICE KIT

- Includes all parts as shown
- Fits:** Vacuum Drain Actuator (OEM Part #40-0742-00) & Vacuum Sink Assembly (OEM Part #55-0200-00)

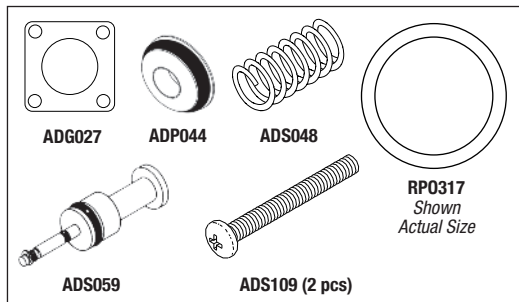

RPI Part #ADC073
OEM Part #028-008-00

PLUG CAP

- 10 per package
- 1/2" OD x 1/4" ID
- Plastic (Red)

Fits: Central Vacuum Solids Separators

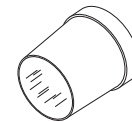

RPI Part #RP0485
OEM Part #034 013 01
Industry Part #AS568-013

O-RING

- 12 per package
 - Material: EPDM, Hardness: 70 Duro
 - Size: .426" ID x .566" OD x .070" C/S
- Fits:** High Vacuum Evacuation: Tip

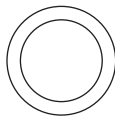

RPI Part #RP0444
OEM Part #034 019 01
Industry Part #AS568-019

O-RING

- 12 per package
 - Material: EPDM, Hardness: 70 Duro
 - Size: .801" ID x .941" OD x .070" C/S
- Fits:** High Vacuum Evacuation: Body & Rotor

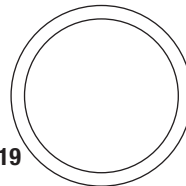

RPI Part #RP0305
OEM Part #030-010-00
Industry Part #AS568-010

O-RING

- 12 per package
 - Material: Nitrile (Buna N), Hardness: 70 Duro
 - Size: .239" ID x .379" OD x .070" C/S
- Fits:** Saliva Ejector: Rotor



RPI Part #RP0488
OEM Part #034-014-01
Industry Part #AS568-014

O-RING

- 12 per package
 - Material: EPDM, Hardness: 70 Duro
 - Size: .489" ID x .625" OD x .070" C/S
- Fits:** High Vacuum Evacuation: Rotor

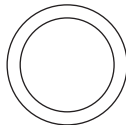

RPI Part #RP0498
OEM Part #034 012 01
Industry Part #AS568-012

O-RING

- 12 per package
 - Material: EPDM, Hardness: 70 Duro
 - Size: .364" ID x .504" OD x .070" C/S
- Fits:** High Vacuum Evacuation: Body & Rotor

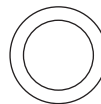

RPI Part #RP0317
OEM Part #030-016-00
Industry Part #AS568-016

O-RING

- 12 per package
 - Material: Nitrile (Buna N), Hardness: 70 Duro
 - Size: .614" ID x .754" OD x .070" C/S
- Models:** High Vacuum Evacuation: Rotor, Vacuum Drain Actuator (OEM Part #40-0742-00) & Vacuum Sink Assembly (OEM Part #55-0200-00)

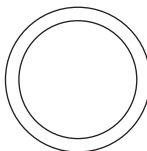

RPI Part #RP0491
OEM Part #034 107 00
Industry Part #AS568-107

O-RING

- 12 per package
 - Material: EPDM, Hardness: 70 Duro
 - Size: .206" ID x .412" OD x .103" C/S
- Fits:** Saliva Ejector: Tip



RPI Part #RP0321
OEM Part #030-034-00
Industry Part #AS568-034

O-RING

- 12 per package
 - Material: Nitrile (Buna N), Hardness: 70 Duro
 - Size: 2.114" ID x 2.254" OD x .070" C/S
- Fits:** Solids Collector Lid

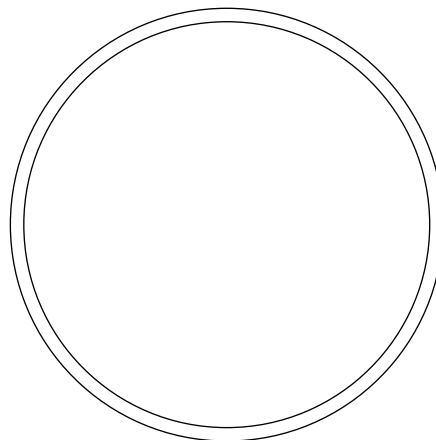

O-Ring illustrations are actual size

**RPI Part #ADS082
OEM Part #22-0040-00**



HELICAL COMPRESSION SPRING

- 10 per package
 - Material: Stainless steel
 - Size: .306" OD x .250" lg. x .026" wire dia.
- Models:** Foot Control (OEM Part #38-0050-00), Foot Control II (OEM Part #38-0254-00), Foot Control III (OEM Part #'s 38.1601.00, 38.1603.00, & 38.1700.00), Foot Control Lever Action (OEM Part #38-0200-00), Foot Control 300 Series (OEM Part #38.1821.00) & Foot Control 500 Series (OEM Part #38.1805.00)

**RPI Part #ADS081
OEM Part #10-0440-00**



HELICAL COMPRESSION SPRING

- 10 per package
 - Material: Stainless steel
 - Size: .092" OD x .230" lg. x .010" wire dia.
- Models:** Foot Control (OEM Part #38-0050-00), Foot Control II (OEM Part #38-0254-00), Foot Control III (OEM Part #'s 38.1601.00, 38.1603.00, & 38.1700.00), Foot Control Lever Action (OEM Part #38-0200-00), Foot Control 300 Series (OEM Part #38.1821.00) & Foot Control 500 Series (OEM Part #38.1805.00)

**RPI Part #ADS091
OEM Part #013-011-00**

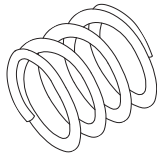

HELICAL COMPRESSION SPRING

- 10 per package
 - Material: Stainless steel
 - Size: .721" OD x .520" lg. x .060" wire dia.
- Fits:** Foot Control II (OEM Part #38-0254-00), Foot Control III (OEM Part #'s 38.1601.00, 38.1603.00, & 38.1700.00), Foot Control 300 Series (OEM Part #38.1821.00) & Foot Control 500 Series (OEM Part #38.1805.00)

**RPI Part #ADS086
OEM Part #22-0580-00**

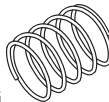

HELICAL COMPRESSION SPRING

- 10 per package
 - Material: Stainless steel
 - Size: .300" OD x .380" lg. x .024" wire dia.
- Models:** Foot Control (OEM Part #38-0050-00), Foot Control III (OEM Part #'s 38.1601.00, 38.1603.00, & 38.1700.00), Foot Control 300 Series (OEM Part #38.1821.00) & Foot Control 500 Series (OEM Part #38.1805.00)

**If it's an RPI part,
it's a part you
can trust.**

**RPI Part #ADS085
OEM Part #22-0135-00**



HELICAL COMPRESSION SPRING

- 10 per package
 - Material: Stainless steel
 - Size: 1.350" OD x .680" lg. x .063" wire dia.
- Model:** Foot Control (OEM Part #38-0050-00)

**RPI Part #ADS046
OEM Part #013-025-00**



HELICAL COMPRESSION SPRING

- 10 per package
 - Material: Stainless steel
 - Size: .245" OD x .260" lg. x .022" wire dia.
- Model:** Foot Control II (OEM Part #38-0254-00) & Handpiece Control Block Century II (OEM Part #38.0223.00)

**RPI Part #ADS045
OEM Part #013-022-00**

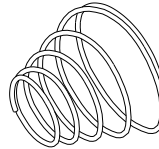

CONICAL COMPRESSION SPRING

- 10 per package
 - Material: Green chromate plated steel
 - Size: .208"/.480" OD x .460" lg. x .030" wire dia.
- Model:** Foot Control II (OEM Part #38-0254-00)

**RPI Part #ADS104
OEM Part #013-019-00**



HELICAL COMPRESSION SPRING

- 10 per package
 - Material: Stainless steel
 - Size: .180" OD x .500" lg. x .016" wire dia.
- Model:** Foot Control Lever Action (OEM Part #38-0200-00)

**RPI Part #ADS105
OEM Part #38-0208-00**

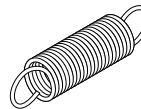

EXTENSION SPRING

- 10 per package
 - Material: Stainless steel
 - Size: .260" OD x 1.025" lg. x .016" wire dia.
- Model:** Foot Control Lever Action (OEM Part #38-0200-00)

**RPI Part #ADS102
OEM Part #22-0460-00**



CONICAL COMPRESSION SPRING

- 10 per package
 - Material: Stainless steel
 - Size: .293"/.252" OD x .350" lg. x .016" wire dia.
- Models:** Coolant Air Valve (OEM Part #22-0940-00), Coolant Water Valve (OEM Part #22-0960-00/22-0790-00) & Air Regulator Valve "White" Bodies (OEM Part #24-0135-00)

**RPI Part #ADS103
OEM Part # (No OEM Part # Available)**



HELICAL COMPRESSION SPRING

- 10 per package
 - Material: Stainless steel
 - Size: .318" OD x .550" lg. x .033" wire dia.
- Models:** Air Filter Regulator (OEM Part #026-021-01) & Water Filter Regulator (OEM Part #40-0654-00)

**RPI Part #ADS062
OEM Part #19-0230-00**

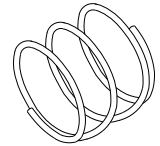

HELICAL COMPRESSION SPRING

- 10 per package
 - Material: Stainless steel
 - Size: .565" OD x .625" lg. x .032" wire dia.
- Models:** Air and Water Shut-Off Valve (Air Operated) (OEM Part #30-0330-00) & Water Filter Regulator (OEM Part #40-0654-00)

**RPI Part #ADS156
OEM Part #013-032-00**

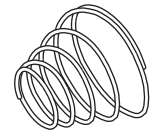

SPRING (CONICAL COMPRESSION)

- 10 per package
 - Material: Stainless steel
 - Size: .260"/.355" OD x .390" lg. x .022" wire dia.
- Model:** Water Regulator Valve "Black" Bodies (OEM Part #24-0355-00)

**RPI Part #ADS195
OEM Part #013-021-00**



COMPRESSION SPRING

- 10 per package
 - Material: Stainless steel
 - Size: .243" OD x .420" lg. x .016" wire dia.
- Model:** Handpiece Control Block Century Plus (OEM Part #38.0540.00)

**RPI Part #ADS048
OEM Part #013-004-00**

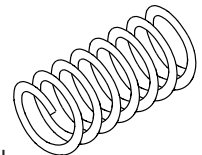

HELICAL COMPRESSION SPRING

- 10 per package
 - Material: Stainless steel
 - Size: .420" OD x .860" lg. x .038" wire dia.
- Fits:** Vacuum Drain Actuator & Vacuum Sink Assembly

**RPI Part #ADS047
OEM Part #013-038-01 / 013.064.01**



CONICAL COMPRESSION SPRING

- 10 per package
 - Material: Stainless steel
 - Size: .125"/.250" OD x .250" lg. x .018" wire dia.
- Fits:** Lever, Soft Touch Button & Continental Syringe

Dental Equipment

Retaining Springs & Rings



RPI Part #ADR253
OEM Part #010.056.00



RETAINING SPRING

- 3 per package
- Material: Stainless Steel
- Size: .62" ID

Models: Foot Control (OEM Part #38-0050-00), Foot Control II (OEM Part #38-0254-00), Foot Control III (OEM Part #'s 38.1601.00, 38.1603.00, & 38.1700.00), Foot Control Lever Action (OEM Part #38-0200-00), Foot Control 300 Series (OEM Part #38.1821.00) & 500 Series (OEM Part #38.1805.00)



RPI Part #ADR240
OEM Part #38.1779.01



RETAINING RING

- 5 per package
- Material: Plastic

Models: Handpiece Control Block 300 Series (OEM Part #38.1831.00) & 500 Series (OEM Part #38.1776.00)

RPI offers a wide selection of general shop aids including screws, nuts, bolts, washers, o-rings and more. Please see the General Shop Aids Section for details.

RPI Part #ADR043
OEM Part #010-019-00



RETAINING RING (EXTERNAL)

- 10 per package
- Fits: .125" dia. shaft
- Also available Vacuum Valve Stem (RPI Part #ADS059)

Fits: Vacuum Sink Assembly, Lever Syringe, Soft Touch Button Syringe & Vacuum Drain Actuator

RPI Part #ADR041
OEM Part #010-013-00



RETAINING RING (INTERNAL)

- 10 per package
 - Fits: .375" dia. hole
- Fits:** Air and Water Shut-Off Valve (Air Operated) (OEM Part #30-0330-00), Foot Control Lever Action (OEM Part #38-0200-00), Needle Valves, and Cartridge Valves

Syringe Parts

RPI Part #ADR043
OEM Part #010-019-00



RETAINING RING (EXTERNAL)

- 10 per package
- Size: .094" ID
- Fits: .125" dia. shaft
- Also in Vacuum Drain Knob Service Kit (RPI Part #ADK033)

Fits: Vacuum Sink Assembly, Lever Syringe, Soft Touch Button Syringe & Vacuum Drain Actuator

RPI Part #ADR042
OEM Part #010-017-00



RETAINING RING (INTERNAL)

- 10 per package
- Size: .250" OD
- Also in Lever Action Foot Control Service Kit (RPI Part #AKD122)

Fits: Drip Syringe & Faucet Assembly

RPI offers a wide selection of general shop aids including screws, nuts, bolts, washers, o-rings and more. Please see the General Shop Aids Section for details.

RPI Part #ADP050
OEM Part #011-038-00

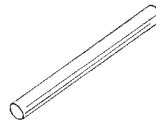

STRAIGHT PIN

- 10 per package
- Material: Stainless steel
- Size: .062 dia. x .430" lg.

Fits: Micro-Selector Valve, 2-Way Routing Selector Valve, 2-Way and 3-Way Toggle Valve & Autoclavable and Continental Syringes

RPI Part #ADS064
OEM Part #23-0886-00

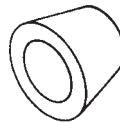

SWIVEL SLEEVE

- 5 per package
 - Material: Brass
- Fits:** Uni-Flo and Tri-Flo Syringe Nut

RPI Part #ADS047
OEM Part #013-038-01 / 013.064.01

CONICAL COMPRESSION SPRING

- 10 per package
- Size: .125/.250" OD x .250" lg. x .018" wire dia.
- Material: Stainless steel

Fits: Lever, Soft Touch Button & Continental Syringe



RPI Part #RPO307
OEM Part #030-006-03/030.006.02
Industry Part #AS568-006/2-006



O-RING

- 12 per package
 - Material: EPDM. Hardness: 70 Duro
 - Size: .114" ID x .254" OD x .070" C/S
- Fits:** Syringe (Rear Adapter)

RPI Part #RPO487
OEM Part #034 003 01
Industry Part #AS568-003



O-RING

- 12 per package
 - Material: EPDM, Hardness: Duro 70
 - Size: .056" ID x .176" OD x .060" C/S
- Fits:** Syringe (Nut)

RPI Part #RPO310
OEM Part #030-002-00
Industry Part #AS568-002



O-RING

- 12 per package
 - Material: Nitrile (Buna N), Hardness: Duro 70
 - Size: .042" ID x .142" OD x .050" C/S
- Fits:** Syringe (Non-Quick Disconnect Barb)

RPI Part #RPT264
OEM Part # (No OEM Part # Available)

Made from stainless steel for greater durability and a longer life than similar aluminum core tool.

VALVE CORE REMOVAL/SYRINGE TOOL

- Long Allen 3/32; Short Allen 5/32
- Stainless steel
- Syringe repair tool
- Removal tool for use with Valve Core (RPI Part #ADV001)

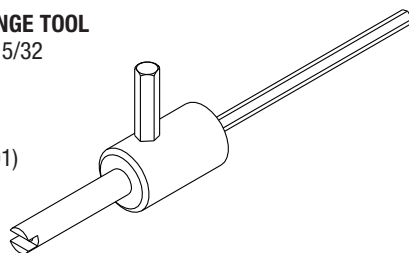

RPI Part #ADV001
OEM Part #026-033-01

VALVE CORE (SHORT)

- 12 per package
- Now has red banding instead of black

Models: Handpiece Control Block Century Water Valve Assembly (OEM Part #38.0098.00), Air Filter Regulator (OEM Part #26-021-01), Filters/Moisture Separator (OEM Part #026-066-00), Tri-Flo Syringe & Uni-Flo Syringe,

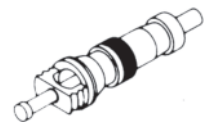

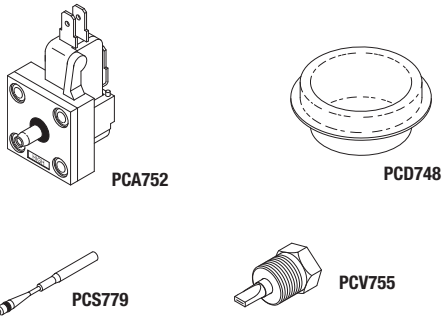

All Parts in Kit Also Sold Separately!

RPI Part #PCK780
OEM Part # (No OEM Part # Available)

FOOT CONTROL VALVE KIT

- Includes all parts as shown
- Fits:** Foot Control Valve Block Assembly
- Models:** Spirit, Spirit II, Spirit IIE & Spirit EC

RPI Part #PCA752
OEM Part #33 03 042/51 74 052

MICRO-SWITCH & DIAPHRAGM ASSEMBLY

- Plastic
- Includes O-ring (RPI Part #RPO314)
- Fits:** Foot Control Valve Block Assembly
- Models:** Spirit, Spirit II, Spirit IIE & Spirit EC

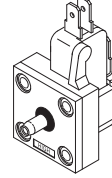

RPI Part #PCS779
OEM Part #33 03 067

STEM

- .092" dia. x 1.440" lg.
- Stainless Steel
- Includes Stem O-ring (RPI Part #RPO310)
- Fits:** Foot Control Valve Block Assembly
- Models:** Spirit, Spirit II, Spirit IIE & Spirit EC

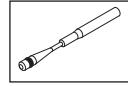

RPI Part #PCV755
OEM Part #33 03 000

CHECK VALVE ASSEMBLY

- Body of valve is brass
- Duckbill is Buna-N
- Fits:** Foot Control Valve Block Assembly
- Models:** Spirit, Spirit II, Spirit IIE & Spirit EC

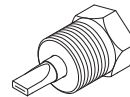

RPI Part #PCD748
OEM Part #33 02 978

REGULATOR DIAPHRAGM

- Acrylonitrile-Butadiene rubber
- Fits:** Foot Control Valve Block Assembly
- Models:** Spirit, Spirit II, Spirit IIE & Spirit EC

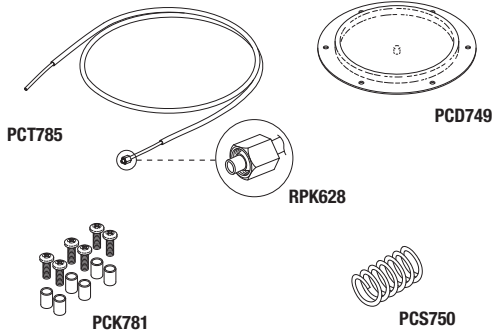
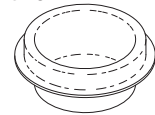

All Parts in Kit Also Sold Separately!

RPI Part #PCK784
OEM Part # (No OEM Part # Available)

FOOT CONTROLLER REPAIR KIT

- Includes all parts as shown
- Fits:** Foot Controller Assembly
- Models:** Spirit, Spirit II, Spirit IIE & Spirit EC

RPI Part #PCD749
OEM #33 02 853

FOOT SWITCH DIAPHRAGM

- 3.188" dia.; Nylon fabric reinforced nitrile
- Fits:** Foot Controller Assembly
- Models:** Spirit, Spirit II, Spirit IIE & Spirit EC

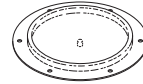

RPI Part #PCT785
OEM #: 023725

FOOT CONTROLLER TUBING ASSEMBLY

- Includes Foot Controller Tubing - 8 ft. (RPI Part #PCT786) and Compression Nut & Sleeve - 1/8" (RPI Part #RPK628)
- Fits:** Foot Controller Assembly
- Models:** Spirit, Spirit II, Spirit IIE & Spirit EC

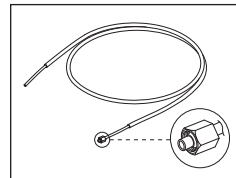

RPI Part #PCS750
OEM #33 02 879

CUSHION SPRING

- .475" OD x .750" lg. x .042" dia. music wire
- Fits:** Foot Controller Assembly
- Models:** Spirit, Spirit II, Spirit IIE & Spirit EC



RPI Part #PCK781
OEM Part # (No OEM Part # Available)

FOOT CONTROLLER SPACER KIT

- Includes: (6) brass spacers .190" ID x .218" OD x .312" lg. and (6) Phillips Pan Head Screws #8-32 x 1/2" lg. (RPI Part #RPH102)
- Fits:** Foot Controller Assembly
- Models:** Spirit, Spirit II, Spirit IIE & Spirit EC

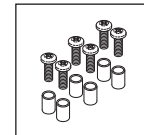

RPI Part #RPK628
OEM Part # (No OEM Part # Available)

COMPRESSION NUT & SLEEVE - 1/8"

- 10 per package; Brass; For use with 1/8" OD tube
- Included in Foot Controller Tubing Assembly (RPI Part #PCT785)
- Fits:** Foot Controller Tubing
- Models:** Spirit, Spirit II, Spirit IIE & Spirit EC

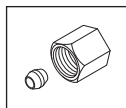

RPI Part #PCT786
OEM Part # (No OEM Part # Available)

FOOT CONTROLLER TUBING

- 25 ft. (tubing can be cut for custom applications)
- Silicone rubber sheath with polyurethane 1/8" OD inner tubing
- Fits:** Foot Controller Assembly or any 1/16" OD barb
- Models:** Spirit, Spirit II, Spirit IIE & Spirit EC

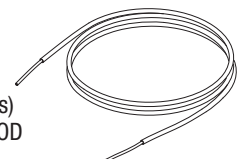

Dental Equipment

Models: Spirit®, Spirit® II, Spirit® IIE, Spirit® AC & Spirit® EC

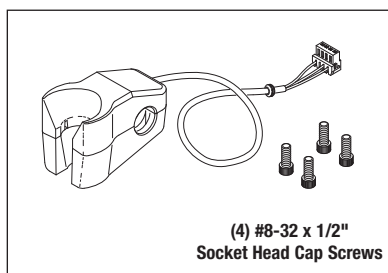

RPI Part #PCK776
New OEM #33 22 315 (Assy.),
15 35 546 (Top) & 15 35 827 (Bottom)
HANDPIECE HANGER ASSEMBLY (WHITE)

- White Nylon
- Photo-interrupter sensor with connector
- Includes all parts as shown

Fits: Delivery Units
Models: Spirit IIE & Spirit EC (prior to October, 1993)

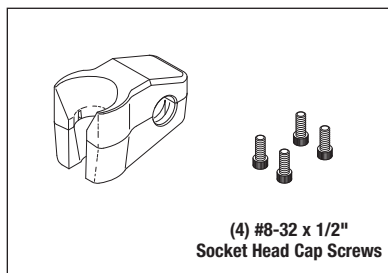

RPI Part #PCK778
OEM Part #33 39 889 (Assy.),
15 24 813 (Top) & 15 35 827 (Bottom)
SYRINGE HANGER ASSEMBLY (WHITE)

- White Nylon
- Includes all parts as shown

Fits: Delivery Units
Models: Spirit IIE & Spirit EC (prior to October, 1993)

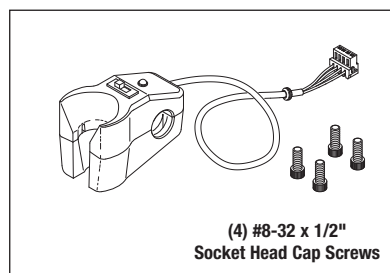

RPI Part #PCK732
OEM Part #021814 (Assy.),
020282 (Top) & 020185 (Bottom)
HANDPIECE HANGER ASSEMBLY (BLACK)

- Black Nylon
- On-off switch with LED
- Photo-interrupter sensor with connector
- Includes all parts as shown

Fits: Delivery Units
Models: Spirit (1983-1990) & Spirit II (1990-1995)

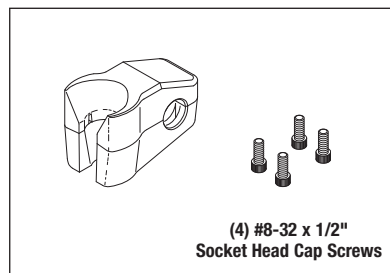

RPI Part #PCK741
OEM Part #021813 (Assy.),
020547 (Top) & 020185 (Bottom)
SYRINGE HANGER ASSEMBLY (BLACK)

- Black Nylon
- Includes all parts as shown

Fits: Delivery Units
Models: Spirit (1983-1990) & Spirit II (1990-1995)

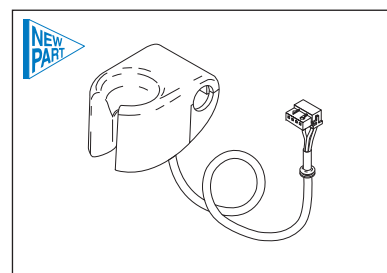

RPI Part #PCK759
OEM Part #15 32 535
HANDPIECE HANGER ASSEMBLY

- White Nylon
- Photo-interrupter sensor with connector
- Two anti-rotational inserts
- Includes (2) mounting screws

Fits: Delivery Unit Handpiece Rail
Models: Spirit EC (After Oct, 1993)

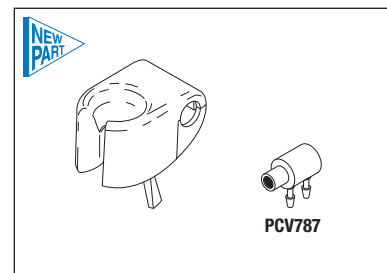

RPI Part #PCK783
OEM Part #33 39 970
HANDPIECE HANGER ASSEMBLY

- White Nylon
- Autoholder Valve (RPI Part #PCV787)
- Two anti-rotational inserts
- Includes (2) mounting screws

Fits: Delivery Unit Handpiece Rail
Models: Spirit AC

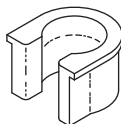

RPI Part #PCI753
OEM Part #020892
INSERT (SYRINGE)

- Black Nylon

Fits: Assistant's Holders (both manual and automatic activation units)
Models: Spirit, Spirit II, Spirit IIE, Spirit AC & Spirit EC

Visit the RPI website:
www.rpiparts.com

Order parts online:
order@rpiparts.com

FREE Tech Support
(800) 221-9723



RPI Part #PCV787
OEM Part #33 07 431
AUTOHOLDER VALVE

- Nickel plated brass
- Normally closed
- 1/16" barb

Fits: Handpiece Hanger Assembly
Model: Spirit AC

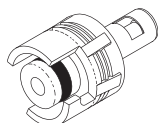

RPI Part #PCC773
OEM Part #94 33 533

MALE QUICK CONNECT (1/16")

- Barb fits 1/16" ID tubing
- Twist to connect
- Coupling rotates freely
- Material: Delrin®
- Mates with Female Quick Connect (1/16") (RPI Part #PCC772)

Fits: Delivery Unit
Model: Spirit AC

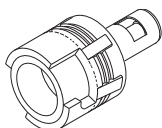

RPI Part #PCC772
OEM Part #94 33 541

FEMALE QUICK CONNECT (1/16")

- Barb fits 1/16" ID tubing
- Twist to connect
- Coupling rotates freely
- Material: Delrin®
- Mates with Male Quick Connect (1/16") (RPI Part #PCC773)

Fits: Delivery Unit
Model: Spirit AC

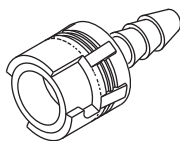

RPI Part #PCC756
OEM Part #94 33 525

IN-LINE COUPLING (1/8")

- Barb fits 1/8" ID tubing
- Twist to connect
- Coupling rotates freely
- Material: Delrin®
- Mates with Male Quick Disconnect (1/8") (RPI Part #PCC757)

Fits: Foot Control Valve Block Assembly
Model: Spirit, Spirit II, Spirit IIE & Spirit EC

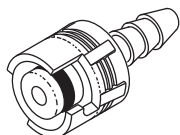

RPI Part #PCC757
OEM Part #94 33 517

MALE QUICK CONNECT (1/8")

- Barb fits 1/8" ID tubing
- Twist to connect
- Coupling rotates freely
- Material: Delrin®
- Mates with In-line Coupling (1/8") (RPI Part #PCC756)

Fits: Foot Control Valve Block Assembly
Models: Spirit, Spirit II, Spirit IIE & Spirit EC

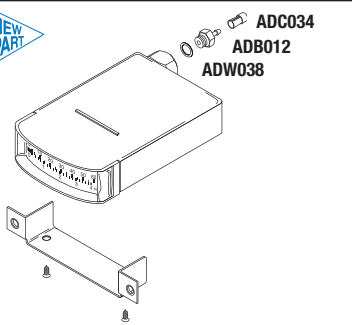

RPI Part #PCG760
OEM Part #30 04 484

PRESSURE GAUGE

- 1-3/4" w x 1/2" h x 2-1/4" lg.
- 0-60 PSI; 0-4 Bar
- Port: #10-32 threaded inlet
- Includes all parts as shown
- **Bracket must be removed for gauge to fit Spirit AC Units**

Fits: Delivery Unit
Models: Spirit AC

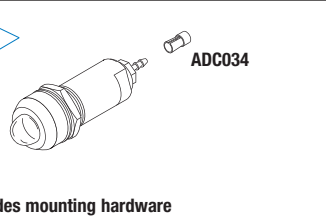

RPI Part #PCL768
OEM Part #30 03 402

AIR INDICATOR (GREEN)

- Nickel plated brass
- Black bezel
- Port: #10-32 threaded inlet with 1/16" barb
- Mounts in 1/2" dia. hole
- Includes all parts as shown

Fits: Delivery Unit
Models: Spirit AC

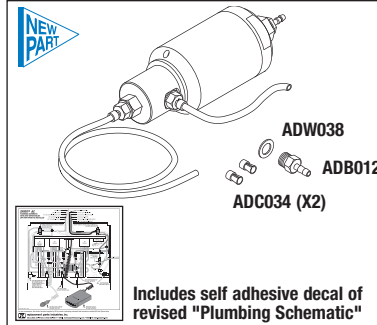

RPI Part #PCK775
OEM Part #51 51 779

ANTI-SIPHON VALVE KIT

- Kit can be used to upgrade from metering valve style to improve water delivery time, or as a replacement for units already upgraded to anti-siphon valve style
- Can also be used as a standard air controlled water valve
- Port: #10-32 threaded inlet with 1/16" barb
- Includes all parts as shown

Fits: Water Delivery Line
Model: Spirit AC (Serial #4839 and below)

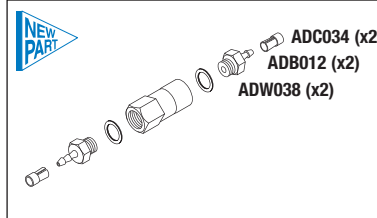

RPI Part #PCV767
OEM Part #18 98 902

CHECK VALVE

- Brass body
- Port: #10-32 threaded inlet with 1/16" barb
- Allows water or air to flow in one direction only
- Includes all parts as shown

Fits: Delivery Unit
Models: Spirit AC



RPI Part #PCV766
OEM Part #15 33 764

VALVE TOGGLE SWITCH

- Replacement for Purge or On/Off Toggle Valve
- Swivels for easy connection to tubing
- Material: Nickel plated brass
- Port: #10-32 threaded inlet with 1/16" barb
- Mounts in 1/2" dia. hole
- Includes all parts as shown

Fits: Delivery Unit
Model: Spirit AC

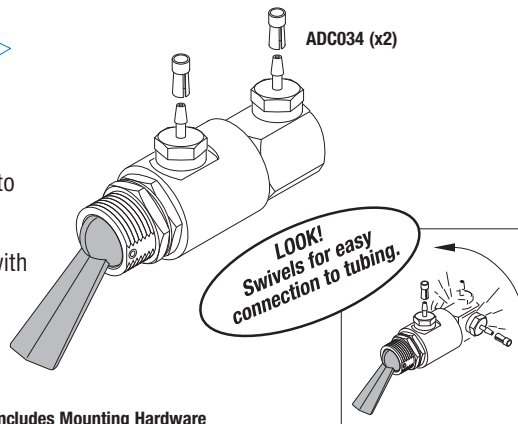

Includes Mounting Hardware

Dental Equipment

Models: Spirit®, Spirit® II, Spirit® IIE, Spirit® AC & Spirit® EC

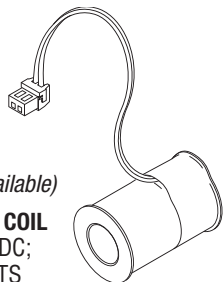

RPI Part #PCC777
OEM Part #
(No OEM Part # Available)

WATER SOLENOID COIL

- Coil Rating: 12VDC; ~44Ω; 3.28WATTS
- Coil: .990" lg. x .620" OD with .363" dia. through hole
- Wire #: 24 AWG; 5-3/8" lg. with JST connector
- Replacement for coil in the Drive Solenoid and Plug Assembly (OEM Part #15 35 371)

Fits: Drive Solenoid and Plug Assembly
Models: Spirit, Spirit II, Spirit IIE & Spirit EC

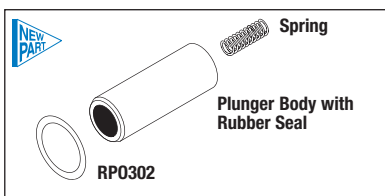

RPI Part #PCK754
OEM Part # *(No OEM Part # Available)*

WATER SOLENOID REPAIR KIT

- Includes all parts as shown
- Fits:** Drive Solenoid and Plug Assembly (OEM Part #15 35 371)
- Models:** Spirit, Spirit II, Spirit IIE & Spirit EC

Use to lube O-rings for easy installation!



RPI Part #RPL090
HIGH TEMP LUBRICANT

- 5 per package
- 1/2 gram per unit
- For non-silicone use only
- Temperature range: -40° to +400°F (-40° to +204°C)
- MSDS and Technical Data Sheet available on RPI website

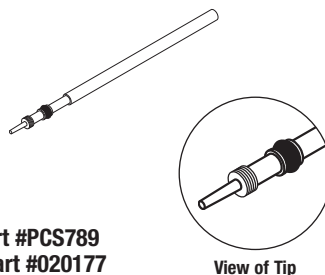

RPI Part #PCS789
OEM Part #020177

WATER VALVE STEM

- 3.13" lg.; Stainless steel
- Includes O-ring (RPI Part #RPO312)
- Fits:** High and Low Speed Handpiece Blocks
- Models:** Spirit, Spirit II, Spirit IIE & Spirit EC

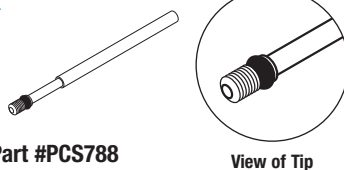

RPI Part #PCS788
OEM Part #021833

AIR VALVE STEM

- 2.56" lg.; Stainless steel
- Includes O-ring (RPI Part #RPO312)
- Uses 3/32" hex key
- Fits:** High and Low Speed Handpiece Blocks
- Models:** Spirit, Spirit II, Spirit IIE & Spirit EC



RPI Part #PCC790
OEM Part #33 02 762

HANDPIECE BLOCK CONNECTOR

- 8 per package
- .365" OD x .365" lg.
- Includes (2) O-rings (RPI Part #RPO305) per connector (installed)
- Brass
- Fits:** High and Low Speed Handpiece Blocks
- Models:** Spirit, Spirit II, Spirit IIE & Spirit EC

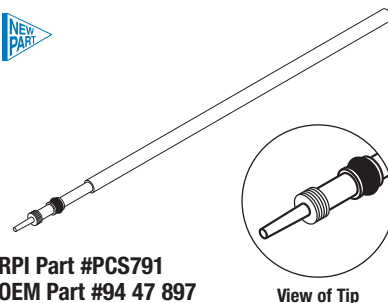

RPI Part #PCS791
OEM Part #94 47 897

WATER VALVE STEM

- 5.60" lg.; Stainless Steel
- Includes O-ring (RPI Part #RPO312)
- Uses 1/8" hex key
- Fits:** Scaler or Electronic Motor Assembly
- Models:** Spirit EC & IIE

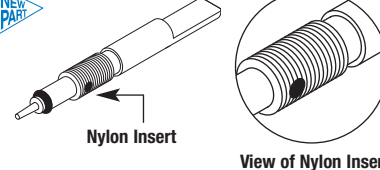

RPI Part #PCV765
OEM Part # *(No OEM Part # Available)*

VALVE STEM

- 1.45" lg.
- Copper with O-ring (RPI Part #RPO310)
- Fits:** Water Adjustment Valve (OEM Part #94 32 774)
- Model:** Spirit AC



RPI Part #RPO617
OEM Part #70 32 741

O-RING

- 12 per package
- .165" ID x .229" OD x .032" X-Sec
- Material: Buna N
- Duro: 70
- Fits:** Upper Valve Stem of Valve Block Assembly (OEM Part #15 37 443)
- Models:** Spirit AC

Pull-Push Wire, Cable, Tubing, and Fiber Optic Bundles with RPI Plastic & Metal Snakes

It's the RPI Advantage!

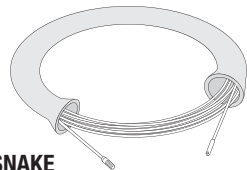

RPI Part #RPT620
PLASTIC TUBING SNAKE

- Metal Snake bends around tight corners for easy work on delivery systems
 - No worries working with the non-conductive Plastic Snake and "J" boxes
 - Easy screw-on tip attachments available for both the Metal and Plastic Snakes
 - Custom designed Fiber-Optic Puller attachment
- For more information, see our website or the General Shop Aids section of the catalog

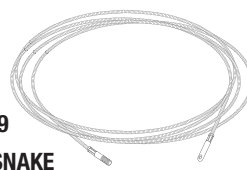

RPI Part #RPT629
METAL TUBING SNAKE

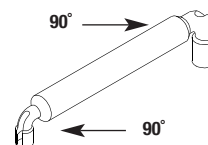

RPI Part #RPT296

UNIVERSAL SLEEVE TOOL

- Use on 1/4" OD tubing and 1/8" OD tubing
- Use to install 1/4" Sleeve clamp (RPI Part #ADC035) and 1/8" Uni-clamp (RPI Part #ADC034)
- The tool provides 90° angles on both ends for ease of use
- ~5" lg.



... Proud to be a **Healthcare Components Group** company ...



**HEALTHCARE
Components Group**

A-DEC

New Parts to fit

A-dec Dental Delivery Units

300 & 500 Series Control Blocks!

RPI Part #ADS279

OEM Part #38.1825.00 (Version 2)

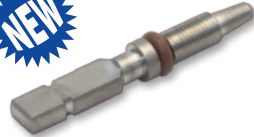

STEM (AIR COOLANT)

- Version 2 design
- Material: Stainless steel
- Double flat stem
- Includes: (1pc) O-Ring (RPI Part #RPO484)
- Also available: Knob (Flow Adj.) (RPI Part #ADK281), High Temp Lubricant (RPI Part #RPL090), and Version 1 Stem (Air Coolant) (RPI Part #ADS234)

Fits: Handpiece Control Block Version 2 (3 and 4 Position) Models: 332, 333, 334, 335, 336 & 541

Models: Stems, Handpiece Control Block 300 Series (38.1871.00), Handpiece Control Block 300 Series (38.1970.00) & Handpiece Control Block 500 Series (38.1972.00)

RPI Part #ADS280

OEM Part #38.1824.00 (Version 2)



STEM (WATER FLOW ADJ.)

- Version 2 design
- Material: Stainless steel
- Double flat stem
- Includes: (1 pc) O-Ring (RPI Part #RPO752)
- Also available: Knob (Flow Adj.) (RPI Part #ADK281), High Temp Lubricant (RPI Part #RPL090), and Version 1 Stem (Water Flow Adj.) (RPI Part #ADS233)

Fits: Handpiece Control Block Version 2 (3 and 4 Position) Models: 332, 333, 334, 335, 336 & 541

Models: Stems, Handpiece Control Block 300 Series (38.1871.00), Handpiece Control Block 300 Series (38.1970.00) & Handpiece Control Block 500 Series (38.1972.00)

RPI Part #ADK281

OEM Part #38.1823.00 (Version 2)



KNOB (FLOW ADJ.)

- Version 2 design
- 5 per package
- Material: Gray polyurethane
- Fits: Double flat stem
- Also available: Stem (Air Coolant) (RPI Part #ADS279) and Stem (Water Flow Adj.) (RPI Part #ADS280)

Fits: Handpiece Control Block Version 2 (3 and 4 Position) Models: 332, 333, 334, 335, 336 & 541

Models: Knobs, Handpiece Control Block 300 Series (38.1871.00), Handpiece Control Block 300 Series (38.1970.00) & Handpiece Control Block 500 Series (38.1972.00)



RPI Part #ADR283

OEM Part #38.1800.01

BARB RETAINER

- Version 1 (3 Position) and Version 2 (3 Position) compatible
- Material: White delrin

Fits: Handpiece Control Block Version 1 and 2 (3 Position) Models: 332, 333, 334, 335, and 336

Models: Barbs and Barb Kits, Handpiece Control Block 300 Series (38.1831.00), Handpiece Control Block 300 Series (38.1871.00)



RPI Part #ADD282

OEM Part #38.1833.01

DIAPHRAGM (3 POSITION)

- Version 1 (3 Position) and Version 2 (3 Position) compatible
- 5 per package
- Material: Fairprene

Fits: Handpiece Control Block Version 1 and 2 (3 Position) Models: 332, 333, 334, 335, and 336

Models: Diaphragms, Handpiece Control Block 300 Series (38.1831.00), Handpiece Control Block 300 Series (38.1871.00)

Don't Forget ...

RPI's offers other parts to fit A-dec 300 & 500 Handpiece Control Blocks including:

- Barb Retainer (4 Position)
- Diaphragm (4 Position)
- Control Block Kit (Major)
- Control Block Kit (Minor)
- Helical Compression Springs
- Many more!



replacement parts industries, inc. A Healthcare Components Group Company

CALL (800) 221-9723 • FAX (818) 882-7028 • EMAIL order@ripiparts.com • WEBSITE www.ripiparts.com

The above parts are manufactured by Replacement Parts Industries, Inc. to fit the equipment noted. All product names used in this document are trademarks or registered trademarks of their respective holders. 2003AD RD1 Show 11/22

SECTION

4

PAGE

554

UPDATED

11/22

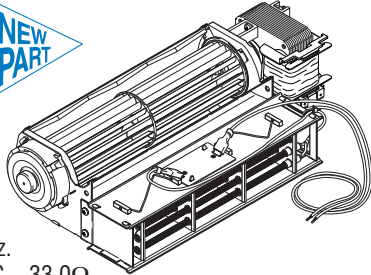

RPI Part #ATA670
OEM Part #43330

HEATER & FAN ASSY.

- Fan: 120VAC, 50/60 Hz.
- Heater: 360W, 120VAC, ~33.0Ω
- Includes FAN (RPI Part #ATF667), Heater Element (RPI Part #ATH668) & Overheat Thermostat (RPI Part #ATT669)
- Does not include the plastic mounting plate. If possible, use the existing mounting plate for installation.

Fits: Cover Assembly

Models: A/T2000, A/T2000 PLUS & A/T2000 XR

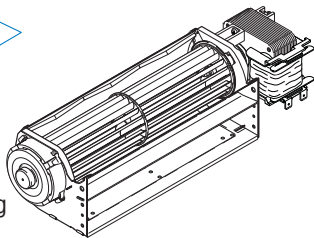

RPI Part #ATF667
OEM Part #43530

FAN

- 120VAC, 50/60 Hz.
- 2.77" W x 3.11" D x 10.43" Lg
- 1/4" tabs

• Also included in Heater and Fan Assembly (RPI Part #ATA670)

Fits: Heater and Fan Assembly

Models: A/T2000, A/T2000 PLUS & A/T2000 XR

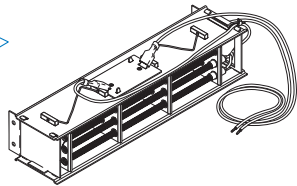

RPI Part #ATH668
OEM Part #43811

HEATER ELEMENT

- 360W, 120VAC, ~33.0Ω
- 1.61" T x 1.69" D x 7.64" Lg
- Includes Overheat Thermostat (RPI Part #ATT669)
- Also included in Heater and Fan Assembly (RPI Part #ATA670)

Fits: Heater and Fan Assembly

Models: A/T2000, A/T2000 PLUS & A/T2000 XR

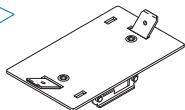

RPI Part #ATT669

OEM Part # (No OEM Part # Available)

OVERHEAT THERMOSTAT

- Factory set at 60° C
- 1/4" tabs
- Can only be used with Heater Element (RPI Part #ATH668) and Heater and Fan Assembly (RPI Part #ATA670)
- RPI Advantage! RPI's Thermostat is replaceable unlike the OEM's Thermostat

Fits: Heater Element

Models: A/T2000, A/T2000 PLUS & A/T2000 XR

RPI Part #ATH639
OEM Part #43290

HEATER BAR ASSEMBLY

- 115V, 100W, 130Ω
- 5kΩ Thermistors @ 25°C
- Includes (2) O-Rings (RPI Part #RPO244)

Fits: Base Assembly

Models: A/T2000 & A/T2000 PLUS

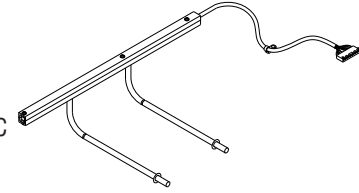

RPI Part #RPO244

OEM Part #43362

INDUSTRY PART #568-203

O-RING

- 6 per package
- Material: Silicone; Color: Red

Fits: Heater Bar Assembly

Models: A/T2000 & A/T2000 PLUS

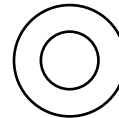

Actual Size

RPI Part #ATA644
OEM Part #43224-1

REMOTE SOLENOID WATER VALVE ASSEMBLY

- 115VAC: 60Hz

Fits: Incoming water line to processor base

Models: A/T2000 & A/T2000 PLUS

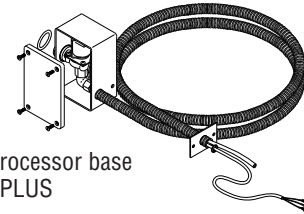

RPI Part #ATV645

OEM Part # (No OEM Part # Available)

SOLENOID VALVE ASSEMBLY

- 115VAC: 60Hz

Fits: Remote Solenoid Water Valve Assembly

Models: A/T2000 & A/T2000 PLUS

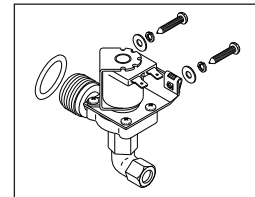

RPI Part #ATS641
OEM Part #43447

WATER LEVEL SENSOR

Fits: Base Assembly

Models: A/T2000 & A/T2000 PLUS

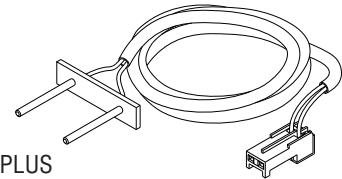

This PC Board is HumiSeal® Conformal Coated!

RPI Part #ATB643
OEM Part #43420

BASE PC BOARD

- 115VAC: 60Hz

Fits: Base Assembly

Models: A/T2000 only

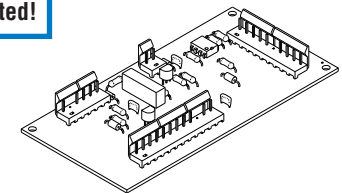

This PC Board is HumiSeal® Conformal Coated!

RPI Part #ATK646
OEM Part #43942

DRIVE MOTOR BOARD WITH HARNESS

- 115 VAC
- Includes: Speed Control PC Board, Butt Connector (RPI Part #RPT011), Wrench, Cable Tie 8" (RPI Part #RPT278), and (2) Cable Tie 4" (RPI Part #RPT083)

Fits: Motor Block Assembly

Models: A/T2000 only

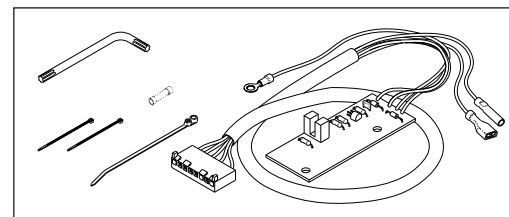

Dental Equipment

Model: A/T2000, A/T2000 PLUS & A/T2000 XR (continued)

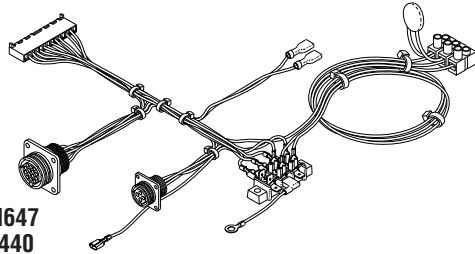

RPI Part #ATH647
OEM Part #43440

BASE WIRING HARNESS

Fits: Base Assembly
Models: A/T2000 only

RPI Part #RPH638
OEM Part #90219

FUSE HOLDER (MAIN)

- 20A @ 250VAC
- 3/16" quick connect tab
- Accommodates standard 1/4" x 1-1/4" fuse
- Fits .50" dia. mounting hole
- Includes mounting hardware

Fits: Back Panel
Models: A/T2000, A/T2000 PLUS & A/T2000 XR

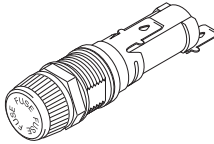

RPI Part #RPF552
OEM Part #41914

FUSE (8A, 250V) - TIME DELAY

- 5 per package
- Type: Ceramic
- Size: 1/4" dia. x 1-1/4" lg.

Fits: Fuse Holder
Models: A/T2000, A/T2000 PLUS & A/T2000 XR

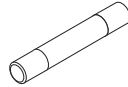

RPI Part #RPF362
OEM Part #43106

LEVELER LEG

- 4 per package
- 1/4-20 x 1-1/2" lg. stem
- Nylon base with 7/8" hex for ease of adjustment

Fits: Leveling Base
Models: A/T2000, A/T2000 PLUS & A/T2000 XR

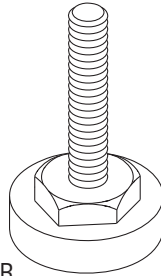

RPI Part #ATS642
OEM Part #30552

THUMB SCREW

- 8 per package
 - 6-32 x 3/8
 - Nylon® 66
- Fits: Molded Base/Fixer & Developer Circulator Cover
Models: A/T2000 & A/T2000 PLUS

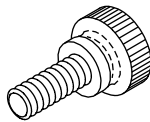

RPI Part #ATW638
OEM Part #43271

DRAIN TUBE WASHER

- 6 per package
 - Material: EPDM
- Fits: Drain Tube
Models: A/T2000, A/T2000 PLUS & A/T2000 XR

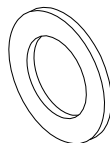

NOTES: _____

**PERI-PRO (90000),
PERI-PRO II (91000)
& PERI-PRO III (94000)**

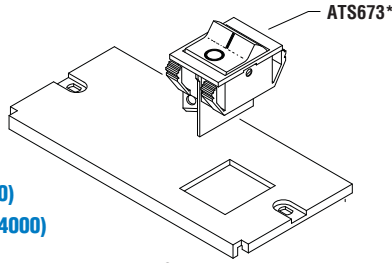

*Peri-Pro S/N #15000 and above & Peri-Pro II S/N #15143 and above

PERI-PRO II (91000)

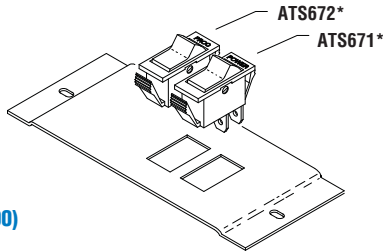

*Peri-Pro II S/N #15142 and below

**PERI-PRO II (91000)
& PERI-PRO III (94000)**

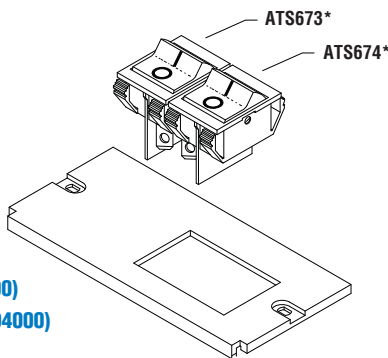

*Peri-Pro II S/N #15143 and above

**SWITCHES TO FIT
PERI-PRO (90000), PERI-PRO II (91000)
& PERI-PRO III (94000)**

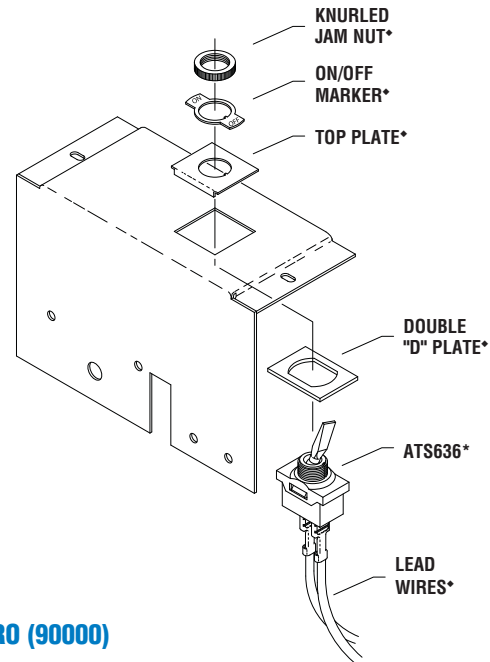

PERI-PRO (90000)

*Peri-Pro S/N #14999 and below

*Included in Power Switch Assembly (RPI Part #ATS636)

RPI PART #	OEM PART #	DESCRIPTION	PKG QTY	PERI-PRO			NOTES
				I	II	III	
ATS636	90221	POWER SWITCH ASSEMBLY	1	1			<ul style="list-style-type: none"> • Black toggle • SPST • 10A@250VAC; 20A@125VAC • Includes mounting hardware (see Footnote * above)
ATS671	116521	PROCESS SWITCH	1		2		<ul style="list-style-type: none"> • Panel cutout: .483" x 1.075" • SPST (on/off) rocker switch; 1/4" tabs • 16A@125/250VAC • Color: white body • Legend: "PROC" marked on bezel
ATS672	116520	POWER SWITCH	1		2		<ul style="list-style-type: none"> • Panel cutout: .483" x 1.075" • SPST (on/off) rocker switch; 1/4" tabs • 16A@125/250VAC • Color: white body • Legend: "POWER" marked on bezel
ATS673	94269 (Black)	POWER SWITCH (AMBER) <i>Note: Regarding the Peri-Pro II only - This black Power Switch (Black) replaces the OEM white Power Switch (OEM Part #90262).</i>	1	3	4	•	<ul style="list-style-type: none"> • Panel cutout: .880 x 1.080" • SPST (on/off) rocker switch; 1/4" tabs • 20A@125VAC • Color: illuminated amber lens; black body • Legend: I/O
ATS674	94977 (New) 94266 (Old)	PROCESS SWITCH (GREEN)	1		4	•	<ul style="list-style-type: none"> • Panel cutout: .880 x 1.080" • SPST (on/off) rocker switch; 1/4" tabs • 20A@125VAC; 28V lamp indicator • Color: illuminated green lens; black body • Legend: I/O

1 = Peri-Pro Serial #14999 and below
3 = Peri-Pro Serial #15000 and above

2 = Peri-Pro II Serial #15142 and below
4 = Peri-Pro II Serial #15143 and above

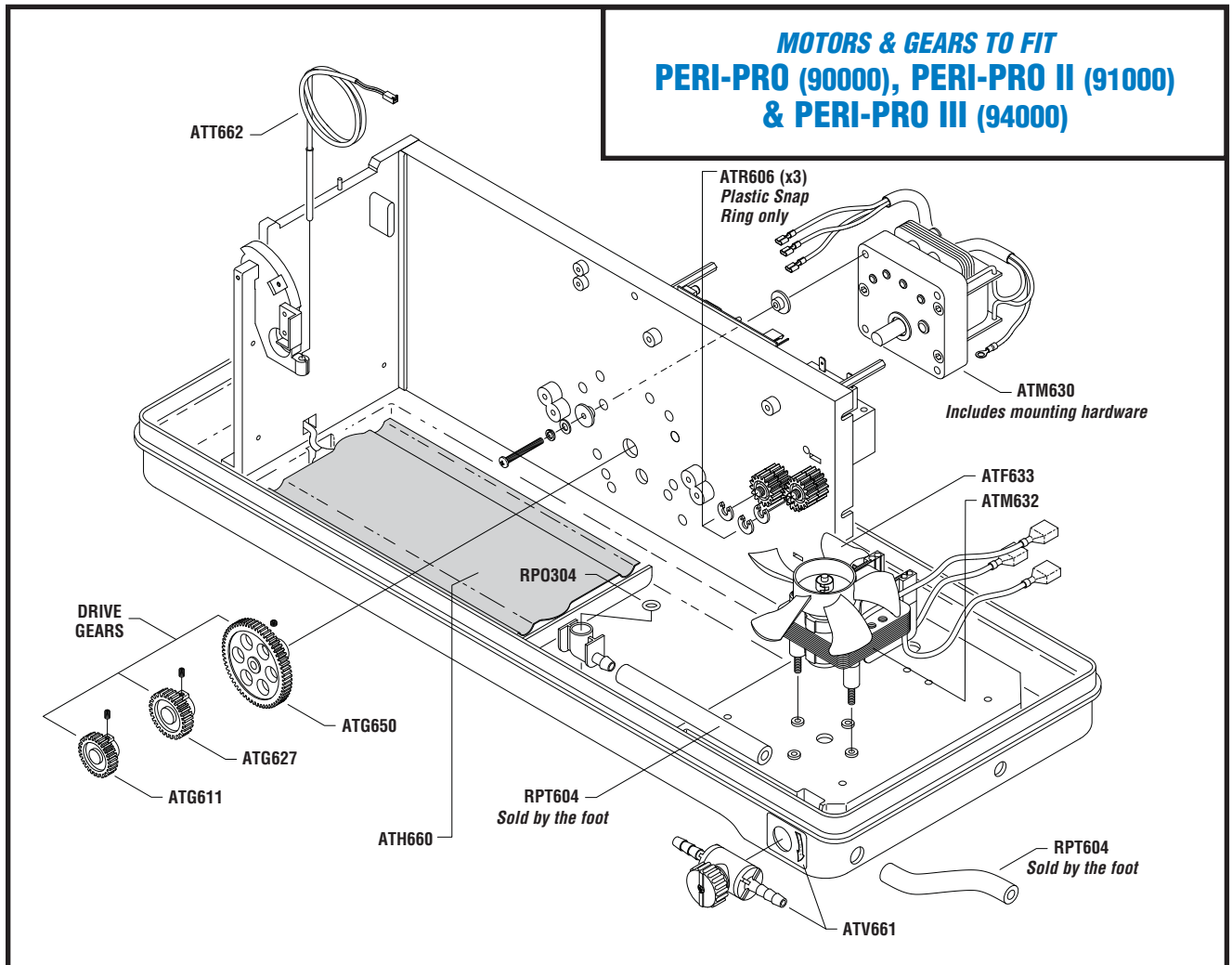

RPI PART #	OEM PART #	DESCRIPTION	PKG QTY	PERI-PRO			NOTES
				I	II	III	
ATG611	90995	MAIN DRIVE GEAR	1	•			<ul style="list-style-type: none"> • 30 teeth; .312" ID x 1.34" OD • Fits: Main Drive Motor
ATG627	90996	MAIN DRIVE GEAR	1		•		<ul style="list-style-type: none"> • 36 teeth; .312" ID x 1.57" OD • Fits: Main Drive Motor
ATG650	94995	MAIN DRIVE GEAR	1			•	<ul style="list-style-type: none"> • 66 teeth; .312" ID x 2.82" OD • Fits: Main Drive Motor
ATH660	94970	HEATER PLATE	1		•		<ul style="list-style-type: none"> • 40W, 24VDC; Thermal cutout opens at 112°F
ATM630	90147	MAIN DRIVE MOTOR	1	•	•	•	<ul style="list-style-type: none"> • 115VAC, 60 Hz. • Includes mounting hardware
ATM632	90880	DRYER FAN & MOTOR ASSEMBLY	1	•	•	•	<ul style="list-style-type: none"> • 115VAC, 60 Hz. • Includes Fan Blade (RPI Part #ATF633) • Includes mounting hardware
ATF633	90102	DRYER FAN BLADE	1	•	•	•	<ul style="list-style-type: none"> • Plastic • Mounts on 3/16" dia. motor shaft • Fits: Fan Motor Assembly
ATT662	94975	THERMISTOR PROBE	1			•	<ul style="list-style-type: none"> • Rated: 5000Ω at 25°C
ATV661	94994	DRAIN VALVE	1			•	<ul style="list-style-type: none"> • Includes valve handle, mounting hardware and decal • 1/4" hose barb
RPO304	60604	O-RING	12			•	<ul style="list-style-type: none"> • .301" ID x .441" OD x .070" C/S
RPT604	94124	DRAIN TUBING	Sold by the foot			•	<ul style="list-style-type: none"> • 1/4" ID x 3/8" OD • Material: clear flexible PVC • Fits: Drain Valve (RPI Part #ATV661)

PERI-PRO (90000)

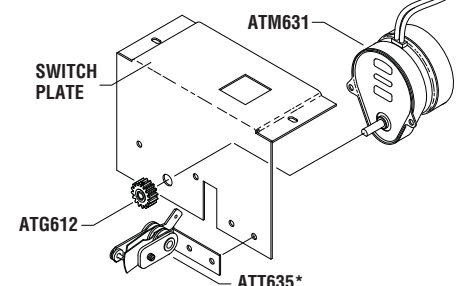

*Peri-Pro S/N #20479 and below

PERI-PRO (90000) & PERI-PRO II (91000)

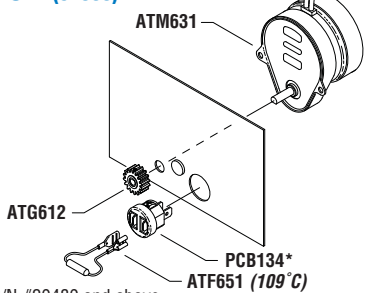

*Peri-Pro S/N #20480 and above

PERI-PRO III (94000)

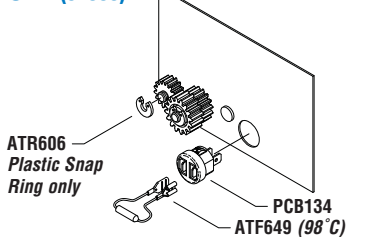

HEATER & FUSES TO FIT PERI-PRO (90000), PERI-PRO II (91000) & PERI-PRO III (94000)

PERI-PRO III (94000)

PERI-PRO (90000) & PERI-PRO II (91000)

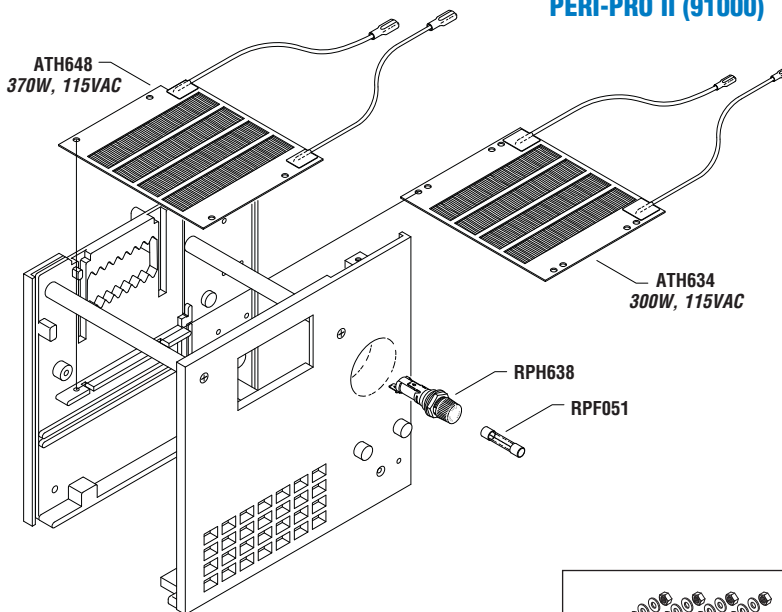

Mounting Hardware included with Heating Elements (RPI Part #ATH634 & ATH648)

RPI PART #	OEM PART #	DESCRIPTION	PKG QTY	PERI-PRO			NOTES
				I	II	III	
ATF649	94278	THERMAL FUSE (98°C) (Only fits Peri-Pro III)	1			•	• Opens at temperature of 98°C • Fits: Terminal Bushing (RPI Part #PCB134)
ATF651	90278	THERMAL FUSE (109°C) (Only fits Peri-Pro I & II)	1	•	•		• Opens at temperature of 109°C • Fits: Terminal Bushing (RPI Part #PCB134)
ATG612	91993	DRYER DRIVE GEAR	1	•	•		• 16 teeth; .188" ID x .75" OD • Fits: Dryer Drive Motor
ATH634	90610	HEATING ELEMENT (DRYER)	1	•	•		• 300W; 115VAC; ~43.8Ω • Use with Thermal Fuse (RPI Part #ATF651) • Includes mounting hardware
ATH648	94630	HEATING ELEMENT (DRYER)	1			•	• 370W; 115VAC; ~35.5Ω • Use with Thermal Fuse (RPI Part #ATF649) • Includes mounting hardware
ATM631	90223	DRYER DRIVE MOTOR	1	•	•		• 115VAC, 60 Hz.
ATT635	90210	THERMOSTAT/BRACKET ASSEMBLY	1	1			• Opens at 165°F
PCB134	117327	ELECTRICAL TERMINAL BUSHING	1	2	•	•	• 3 per package • Mounts Thermal Fuse
RPF051	90265	FUSE (5A, 250VAC)	5	•	•	•	• Type: Glass; AGC Fast Acting • Size: 1/4" dia. x 1-1/4" lg.
RPH638	90219	FUSE HOLDER (MAIN)	1	•	•	•	• 3/16" quick connect tab • Accommodates standard 1/4" x 1-1/4" fuse • 20A@250VAC • Fits .50" dia. mounting hole • Includes mounting hardware

1 = Peri-Pro Serial #20479 and below

2 = Peri-Pro Serial #20480 and above

Call Us Toll-Free Monday-Friday, 8:00 AM-4:30 PM (Pacific Time), (800) 221-9723



EXPLODED VIEW OF PERI-PRO (90000) & PERI-PRO II (91000)

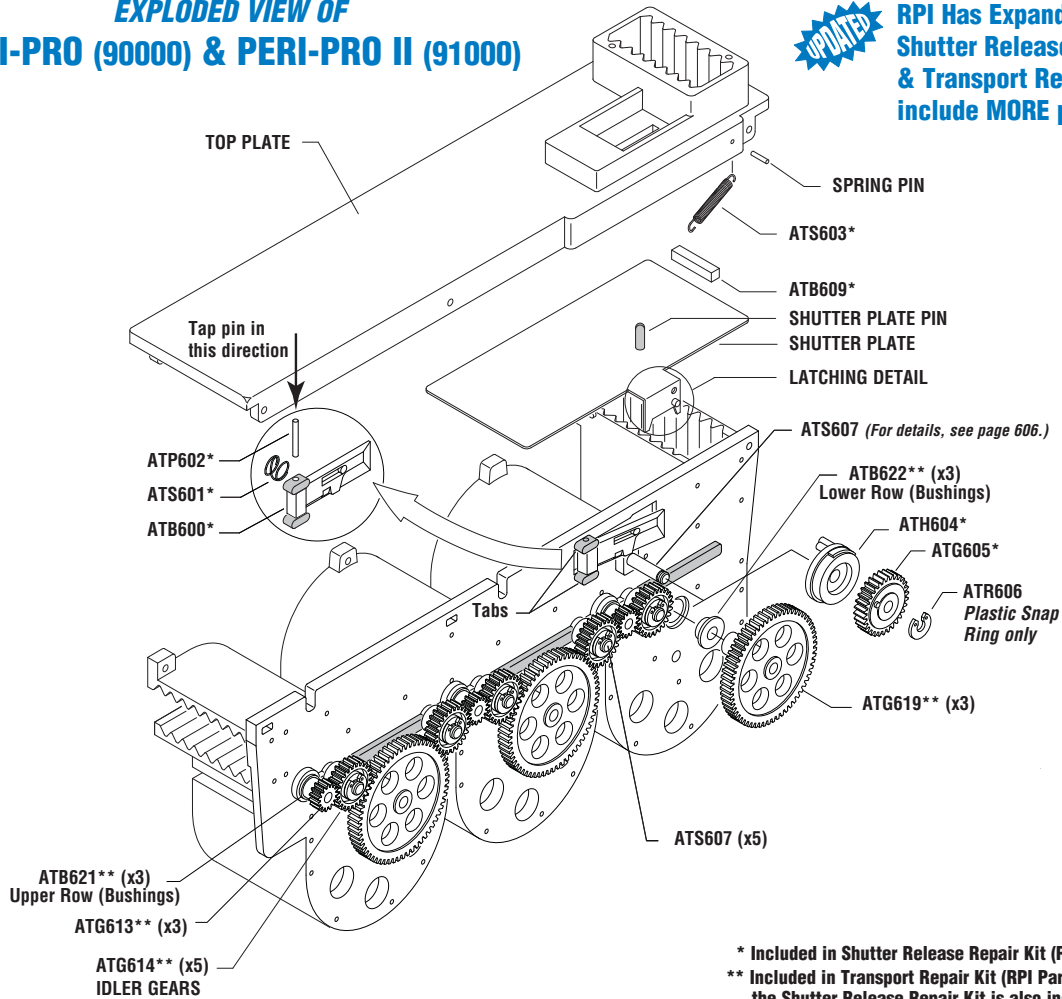

* Included in Shutter Release Repair Kit (RPI Part #ATK628)
 ** Included in Transport Repair Kit (RPI Part #ATK629) PLUS the Shutter Release Repair Kit is also include in this Kit!

RPI PART #	OEM PART #	DESCRIPTION	KIT QTY	Reorder PKG QTY	PERI-PRO		NOTES
					I	II	
ATK629	90988	TRANSPORT REPAIR KIT		1	•	•	UPDATED Now includes all parts listed below
ATB616	90522	TRANSFER ARM BEARING	3	3	•	•	Fits: Transfer Arm Assemblies
ATB621	90523	"L" TRANSFER ARM BUSHING	6	6	•	•	Fits: Upper rows; .188" dia. shaft
ATB622	90524	TRANSFER ARM BUSHING	6	6	•	•	Fits: Lower rows; .250" shaft UPDATED Now includes 6 per package
ATG613	90525	"L" TRANSFER ARM GEAR	3	3	•	•	15 teeth; .171" ID x .70" OD
ATG614	90519	IDLER GEAR	5	5	•	•	24 teeth; .250" ID x 1.08" OD UPDATED Now includes 5 per package
ATG615	90518	TRANSFER ARM GEAR	3	3	•	•	24 teeth; .250" ID x 1.08" OD
ATG619	90517	TRANSFER ARM GEAR	3	1	•	•	60 teeth; .250" ID x 2.57" OD
ATG620	90516	TRANSFER GEAR	3	3	•	•	24 teeth; .250" ID x 1.08" OD
ATK628	(No OEM Part # Available)	SHUTTER RELEASE REPAIR KIT	1	1	•	•	See below for all parts included in this Kit
ATR606	90543	PLASTIC SNAP RING	10	10	•	•	
ATK628	(No OEM Part # Available)	SHUTTER RELEASE REPAIR KIT		1	•	•	UPDATED Now includes all parts listed below
ATB600	90548	SHUTTER RELEASE BAR	1	1	•	•	New Steel Stopper Pin for better performance
ATB609	90546	RUBBER BUMPER	1	6	•	•	Use Silicone Gasket Maker 598 (RPI Part#RPS639)
ATG605	90521	TIMER GEAR	1	1	•	•	30 teeth; .250" ID x 1.34" OD
ATH604	90540	HUB & PIN ASSEMBLY	1	1	•	•	Includes hub, and (2) stainless steel pins
ATP602	30391	SPRING PIN	1	6	•	•	Stainless steel; .093" OD x .937" lg.
ATR606	90543	PLASTIC SNAP RING	1	10	•	•	UPDATED Now includes 10 per package
ATS601	90545	COMPRESSION SPRING	1	6	•	•	Stainless steel; .375" OD x .250" lg. x .026" wire
ATS603	90512	SHUTTER RETURN SPRING	1	3	•	•	Stainless steel; .190" OD x 1.620" lg. x .020" wire

EXPLODED VIEW OF PERI-PRO (90000) & PERI-PRO II (91000)

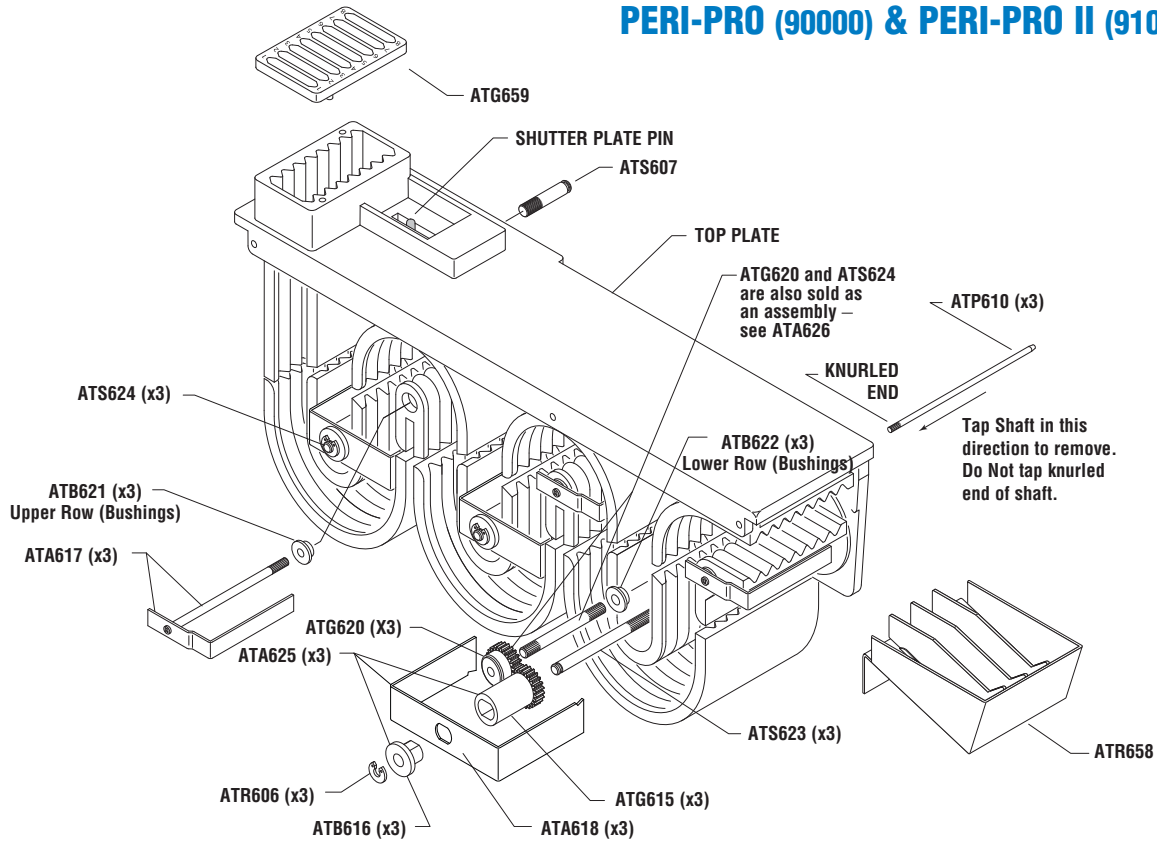

* Included in Shutter Release Repair Kit (RPI Part #ATK628)

** Included in Transport Repair Kit (RPI Part #ATK629)

RPI PART #	OEM PART #	DESCRIPTION	PKG QTY	PERI-PRO		NOTES
				I	II	
ATA617	90520	"L" TRANSFER ARM ASSEMBLY	1	•	•	Fits: Transport Assembly
ATA618	90564	"U" TRANSFER ARM	1	•	•	Fits: "U" Transfer Arm Assy (RPI Part #ATA625)
ATA625	90530	"U" TRANSFER ARM ASSEMBLY	1	•	•	Includes "U" Transfer Arm (RPI Part #ATA618), Transfer Gear (RPI Part #ATG615) and Transfer Arm Bearing (RPI Part #ATB616)
▶ ATG659	90555	FILM INLET GRILLE	1	•	•	
▶ ATP610	90505	TOP PLATE PIN	1	•	•	Stainless Steel; .125" OD x 3.562" lg. (Sold Individually; Transport requires 3)
▶ ATR658	90810	FILM RECEPTACLE	1	•	•	Fits: Outer Cover
ATS623	90504	TRANSFER ARM SHAFT	1	•	•	Stainless Steel; .250" OD x 3.234" lg.
ATS607	90502	IDLER GEAR SHAFT	1	•	•	Stainless Steel; .250" OD x 1.085" lg.
ATA626	90550	"U" TRANSFER DRIVE ASSEMBLY		•	•	Includes all parts listed below
ATS624	90506	TRANSFER DRIVE SHAFT	1	•	•	Stainless Steel; .250" OD x 2.463" lg.
ATG620	90516	TRANSFER GEAR	1*	•	•	24 teeth; .250" ID. X 1.08" OD

* RPI Part #ATG620 is also sold separately as a package quantity of 3 pieces.

NOTES: _____

Dental Equipment

Models: Peri-Pro[®] (90000), Peri-Pro II[®] (91000) & Peri-Pro III[®] (94000) (continued)

EXPLODED VIEW OF PERI-PRO III (94000)



NOW AVAILABLE!
Shutter Release Repair Kit
& Transport Repair Kit!

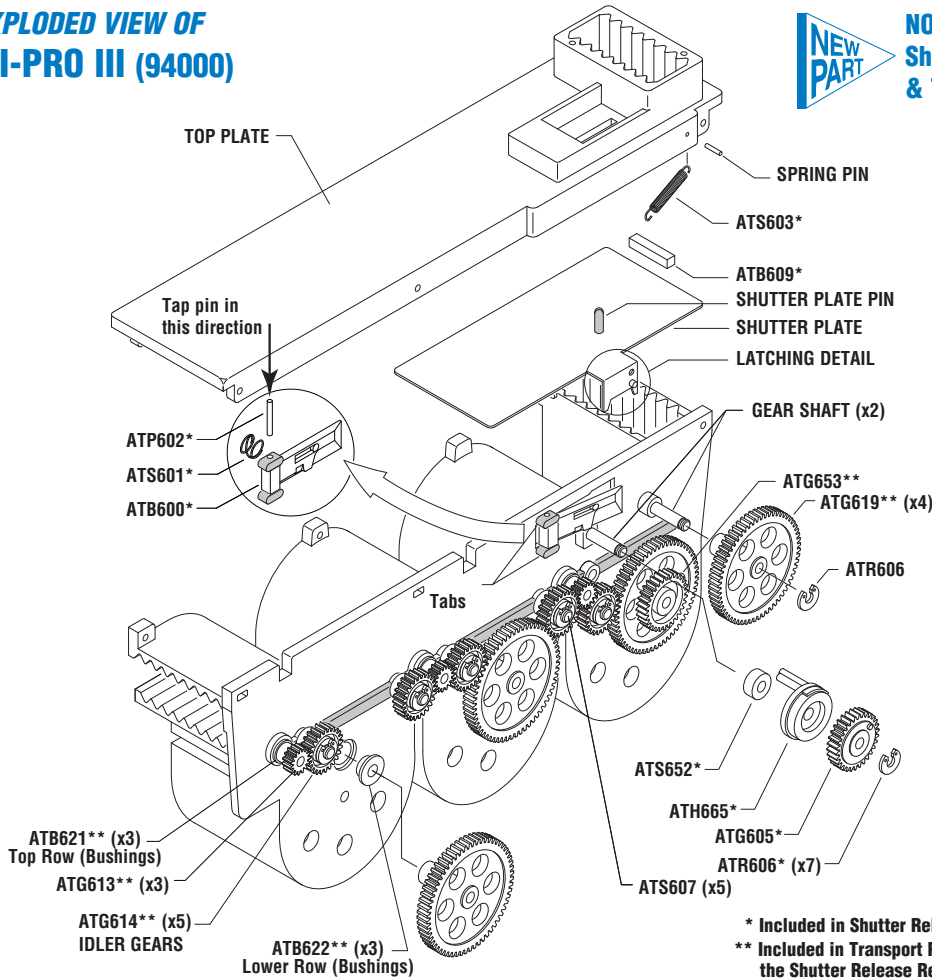

* Included in Shutter Release Repair Kit (RPI Part #ATK664)
** Included in Transport Repair Kit (RPI Part #ATK663) PLUS
the Shutter Release Repair Kit is also include in this Kit!

RPI PART #	OEM PART #	DESCRIPTION	KIT QTY	Reorder PKG QTY	PERI-PRO III	NOTES
ATK663	94988	TRANSPORT REPAIR KIT		1	•	<i>Includes all parts listed below</i>
ATB616	90522	TRANSFER ARM BEARING	3	3	•	Fits: Transfer Arm Assemblies
ATB621	90523	"L" TRANSFER ARM BUSHING	6	6	•	Fits: Upper rows; .188" dia. shaft
ATB622	90524	TRANSFER ARM BUSHING	6	6	•	Fits: Lower rows; .250" shaft Now includes 6 per package
ATG613	90525	"L" TRANSFER ARM GEAR	3	3	•	15 teeth; .171" ID x .70" OD
ATG614	90519	IDLER GEAR	5	5	•	24 teeth; .250" ID x 1.08" OD Now includes 5 per package
ATG615	90518	TRANSFER ARM GEAR	3	3	•	24 teeth; .250" ID x 1.08" OD
ATG619	90517	TRANSFER ARM GEAR	4	1	•	60 teeth; .250" ID x 2.57" OD
ATG620	90516	TRANSFER GEAR	3	3	•	24 teeth; .250" ID x 1.08" OD
ATG653	94501	SPEED REDUCER GEAR	1	1	•	30 teeth
ATK664	(No OEM Part # Available)	SHUTTER RELEASE REPAIR KIT	1	1	•	<i>See below for all parts included in this Kit</i>
ATR606	90543	PLASTIC SNAP RING	10	10	•	
ATK664	(No OEM Part # Available)	SHUTTER RELEASE REPAIR KIT		1	•	<i>Includes all parts listed below</i>
ATB600	90548	SHUTTER RELEASE BAR	1	1	•	New Steel Stopper Pin for better performance
ATB609	90546	RUBBER BUMPER	1	6	•	Use Silicone Gasket Maker 598 (RPI Part#RPS639)
ATG605	90521	TIMER GEAR	1	1	•	30 teeth; .250" ID x 1.34" OD
ATH665	94540	HUB & PIN ASSEMBLY	1	1	•	Includes hub, and (2) stainless steel pins
ATP602	30391	SPRING PIN	1	6	•	Stainless steel; .093" OD x .937" lg.
ATR606	90543	PLASTIC SNAP RING	1	10	•	Now includes 10 per package
ATS601	90545	COMPRESSION SPRING	1	6	•	Stainless steel; .375" OD x .250" lg. x .026" wire
ATS603	90512	SHUTTER RETURN SPRING	1	3	•	Stainless steel; .190" OD x 1.620" lg. x .020" wire
ATS652	(No OEM Part # Available)	SPACER	1	3	•	Nylon [®] ; .260" ID x .500" OD x .250" Thk

FAX: (818) 882-7028 • E-MAIL: order@rpiarts.com • WEBSITE: www.rpiarts.com

EXPLODED VIEW OF PERI-PRO III (94000)

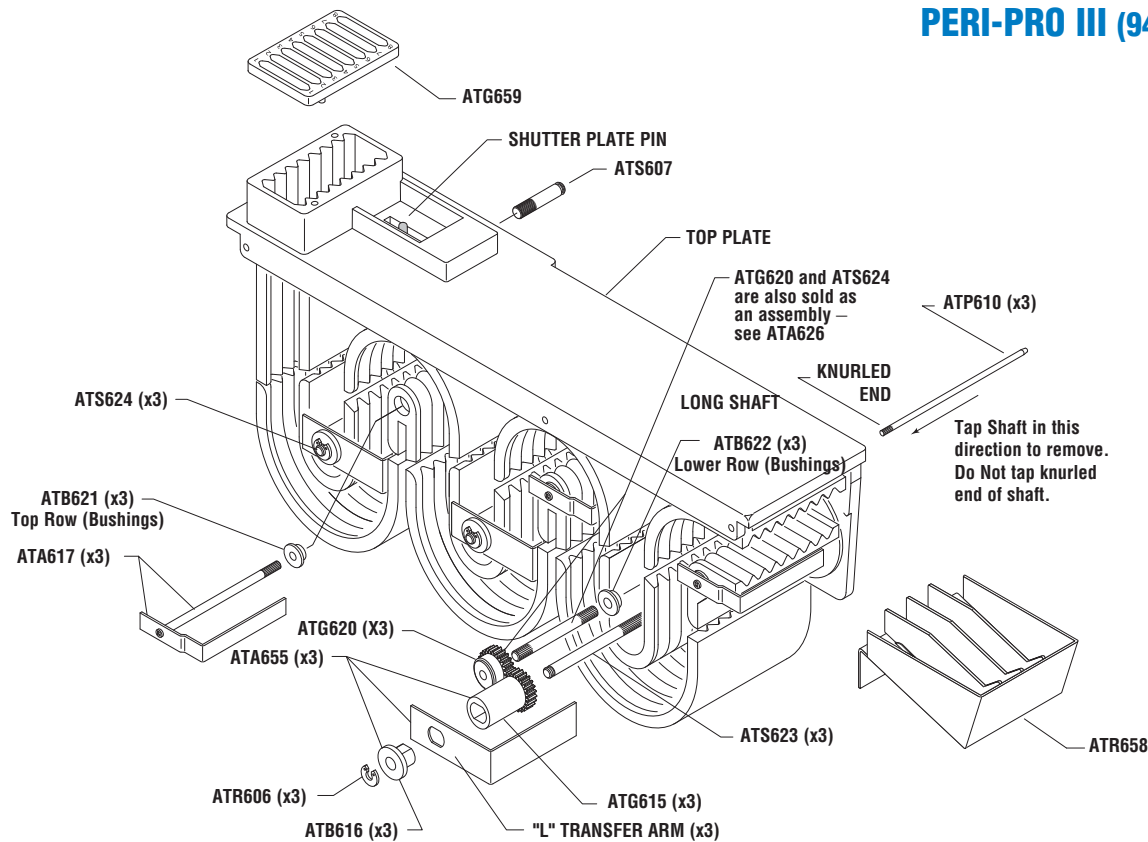

* Included in Shutter Release Repair Kit (RPI Part #ATK664)

** Included in Transport Repair Kit (RPI Part #ATK663)

RPI PART #	OEM PART #	DESCRIPTION	PKG QTY	PERI-PRO III	NOTES
ATA617	90520	"L" TRANSFER ARM ASSEMBLY	1	•	Fits: Transport Assembly
ATA655	94530	"L" TRANSFER ARM ASSEMBLY	1	•	Includes "L" Transfer Arm, Transfer Gear (RPI Part #ATG615) and Transfer Arm Bearing (RPI Part #ATB616)
ATG659	90555	FILM INLET GRILLE	1	•	
ATP610	90505	TOP PLATE PIN	1	•	Stainless Steel; .125" OD x 3.562" lg. (Sold Individually; Transport requires 3)
ATR658	90810	FILM RECEPTACLE	1	•	Fits: Outer Cover
ATS623	90504	TRANSFER ARM SHAFT	1	•	Stainless Steel; .250" OD x 3.234" lg.
ATS607	90502	IDLER GEAR SHAFT	1	•	Stainless Steel; .250" OD x 1.085" lg.
ATA626	90550	"U" TRANSFER DRIVE ASSEMBLY	1	•	Includes all parts listed below
ATS624	90506	TRANSFER DRIVE SHAFT	1	•	Stainless Steel; .250" OD x 2.463" lg.
ATG620	90516	TRANSFER GEAR	1*	•	24 teeth; .250" ID. X 1.08" OD

* RPI Part #ATG620 is also sold separately as a package quantity of 3 pieces.

NOTES:

RPI Part #PHP016
OEM Part #874-026393
SHORT DOUBLE KNURL PIN

- 5 per package
- Stainless steel
- 3/16" Dia. x 1-1/16" Lg.

Fits: Short Pin Plastic Roller (Developer, Fixer and Washer/Dryer Transport Module)
Models: 810 & 9000



RPI Part #PHP017
OEM Part #874-026883
LONG DOUBLE KNURL PIN

- 5 per package
- Stainless steel
- 3/16" Dia. x 1-1/2" Lg.

Fits: Long Pin Plastic Roller (Developer, Fixer and Washer/Dryer Transport Module)
Models: 810 & 9000



RPI Part #PHP018
OEM Part #874-026754
SHORT MIDDLE KNURL PIN

- 5 per package
- Stainless steel
- 3/16" Dia. x 1-1/16" Lg.

Fits: Short Pin Plastic Roller, Long Pin Plastic Roller, Ingress Plastic Roller, and Ingress Plastic Roller Assembly (Developer, Fixer and Washer/Dryer Transport Module)
Models: 810 & 9000



RPI Part #PHP019
OEM Part # N/A
LARGE KNURL PIN

- 5 per package
- Stainless steel
- 1/4" Dia. x 1-5/16" Lg.

Fits: Large Knurl Pin, Ingress Drive Shaft Assembly, Gear with Drilled Shaft, and Ingress Plastic Roller Assembly Developer, Fixer and Washer/Dryer Transport Module)
Models: 810 & 9000



ROLLER COMPONENTS CHART

	#1 Rubber Roller Assembly with Clip RPI Part #PHR001 OEM Part #874-00007	#2 Rubber Roller Assembly with Clip RPI Part #PHR002 OEM Part #874-01007	#3 Rubber Roller Assembly with Clip RPI Part #PHR003 OEM Part #874-02007	Short Pin Plastic Roller RPI Part #PHR004 OEM Part #874-00007	Long Pin Plastic Roller RPI Part #PHR006 OEM Part #874-00007	Ingress Plastic Roller Assembly RPI Part #PHR005 OEM Part # N/A	Ingress Plastic Roller Assembly RPI Part #PHR025 OEM Part #874-00007
Short Double Knurl Pin RPI Part #PHP016 OEM Part #874-026393				●			
Long Double Knurl Pin RPI Part #PHP017 OEM Part #874-026883					●		
Short Middle Knurl Pin RPI Part #PHP018 OEM Part #874-026754			●	●	●	●	
Large Knurl Pin RPI Part #PHP019 OEM Part # N/A				●			
Ingress Drive Shaft Assembly RPI Part #PHA022 OEM Part #866-02207						●	
Retaining Clip RPI Part #PHC015 OEM Part #875-033007	●	●					

RPI Part #PHC015
OEM Part #875-033007
RETAINING CLIP

- 5 per package
- Stainless steel
- 1/4" ID

Fits: #1 and #2 Rubber Roller Assembly (Developer, Fixer and Washer/Dryer Transport Module)
Models: 810 & 9000



RPI Part #PHS024
OEM Part #800-045461
IDLER SPRING

- 5 per package
- Stainless steel

Fits: Transport Drive Shaft Assembly (Developer and Fixer Transport Module)
Models: 810 & 9000



RPI Part #PHC020
OEM Part #866-010007
TRANSPORT DRIVE CHAIN

- Stainless steel

Fits: Developer and Fixer Transport Module
Models: 810 & 9000

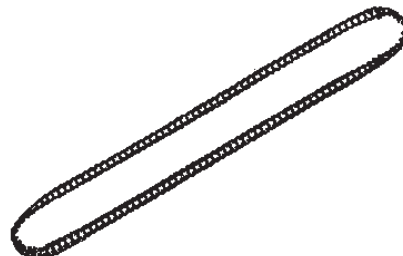

RPI Part #PHC021
OEM Part #867-010007
WASHER/DRYER DRIVE CHAIN

- Stainless steel

Fits: Washer/Dryer Transport Module
Models: 810 & 9000

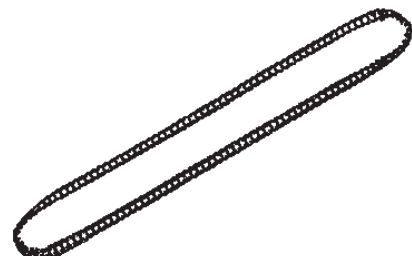

Dental Equipment

Models: 810 & 9000 Developer, Fixer & Washer/Dryer Transport Module (continued)

RPI Part #PHG009
OEM Part #875-000007

GEAR

- 10 per package
- Plastic
- 3/16" ID, 12 Teeth

Fits: Developer, Fixer and Washer/Dryer Transport Module
Models: 810 & 9000



RPI Part #PHS013
OEM Part #875-040007

SPROCKET

- 10 per package
- Plastic
- 3/16" ID, 9 Teeth

Fits: Developer, Fixer and Washer/Dryer Transport Module
Models: 810 & 9000



RPI Part #PHG010
OEM Part #875-010007

GEAR

- 10 per package
- Plastic
- 1/4" ID, 12 Teeth

Fits: Developer, Fixer and Washer/Dryer Transport Module
Models: 810 & 9000



RPI Part #PHS014
OEM Part #875-050007

SPROCKET

- 10 per package
- Plastic
- 1/4" ID, 9 Teeth

Fits: Developer, Fixer and Washer/Dryer Transport Module
Models: 810 & 9000



RPI Part #PHG011
OEM Part #875-020007

GEAR

- 2 per package
- Plastic
- 3/16" ID, 27 Teeth

Fits: Developer and Fixer Transport Module
Models: 810 & 9000



RPI Part #PHA022
OEM Part #866-022007

INGRESS DRIVE SHAFT ASSEMBLY

- Stainless steel
 - Includes gear (RPI Part #PHG012), and large knurl pin (RPI Part #PHP019)
- Fits:** Ingress Plastic Roller Assembly (RPI Part #PHR025) (Developer and Fixer Transport Module)
Models: 810 & 9000



RPI Part #PHG012
OEM Part #875-030007

GEAR

- Stainless steel
- 1/4" ID, 12 Teeth

Fits: Large Knurl Pin (RPI Part #PHP019), Gear with Drilled Shaft and Ingress Plastic Roller Assembly (RPI Part #PHR025) (Developer, Fixer and Washer/Dryer Transport Module)
Models: 810 & 9000



RPI Part #PHA023
OEM Part #866-021007

GEAR WITH DRILLED SHAFT

- Stainless steel
 - Includes gear (RPI Part #PHG012), and drilled shaft
- Fits:** Developer and Fixer Transport Module
Models: 810 & 9000



Our friendly, knowledgeable customer service representatives are here to assist you.

RPI Part #PHR001
OEM Part #874-000007

#1 RUBBER ROLLER

- 1/4" OD stainless steel shaft
- Includes retaining clip (RPI Part #PHC015)

Fits: Developer, Fixer and Washer/Dryer Transport Module
Models: 810 & 9000

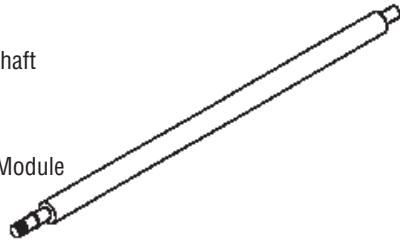

RPI Part #PHR002
OEM Part #874-010007

#2 RUBBER ROLLER

- 1/4" OD stainless steel shaft
- Includes retaining clip (RPI Part #PHC015)

Fits: Developer, Fixer and Washer/Dryer Transport Module
Models: 810 & 9000

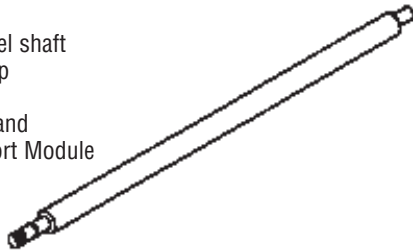

RPI Part #PHR003
OEM Part #874-020007

#3 RUBBER ROLLER

- 1/4" OD stainless steel shaft
- Knurled both ends

Fits: Developer, Fixer and Washer/Dryer Transport Module
Models: 810 & 9000

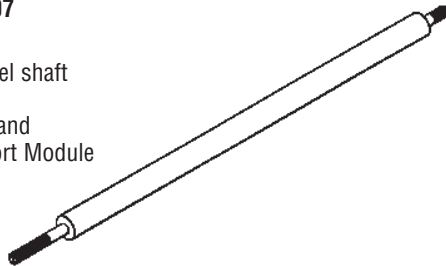

RPI Part #PHR004
OEM Part #874-030007

SHORT PIN ROLLER

- Plastic
- Includes stainless steel short double knurl pin (RPI Part #PHP016), and short middle knurl pin (RPI Part #PHP018)

Fits: Developer, Fixer and Washer/Dryer Transport Module
Models: 810 & 9000

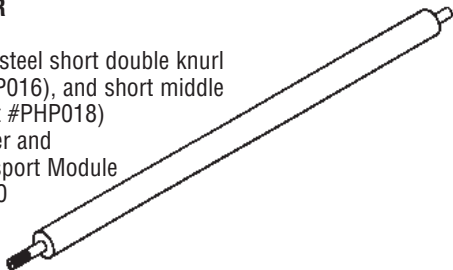

RPI Part #PHR005
OEM Part #874-040007

LONG PIN ROLLER

- Plastic
- Includes stainless steel long double knurl pin (RPI Part #PHP017), and short middle knurl pin (RPI Part #PHP018)

Fits: Developer, Fixer and Washer/Dryer Transport Module
Models: 810 & 9000

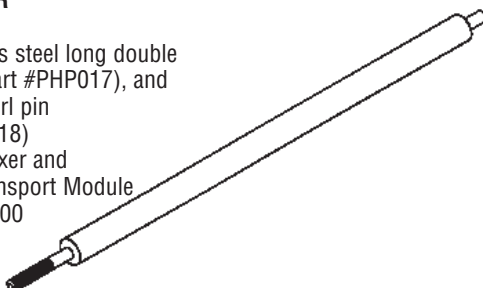

RPI Part #PHR006
OEM Part # N/A

INGRESS ROLLER

- Plastic
- Includes stainless steel short middle knurl pin (RPI Part #PHP018), and large knurl pin (RPI Part #PHP019)

Fits: Developer, Fixer and Washer/Dryer Transport Module
Models: 810 & 9000

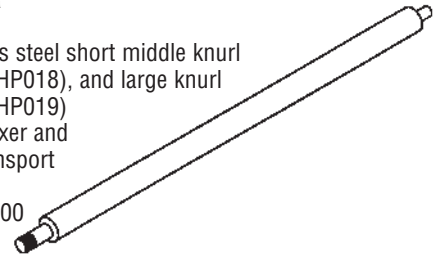

RPI Part #PHH007
OEM Part #874-070007

HANGER ASSEMBLY

- Plastic
- Includes plastic spreader, (2) plastic hanger, and (2) 1/4-20 x 1-1/2" Allen head screw

Fits: Developer, Fixer and Washer/Dryer Transport Module
Models: 810 & 9000

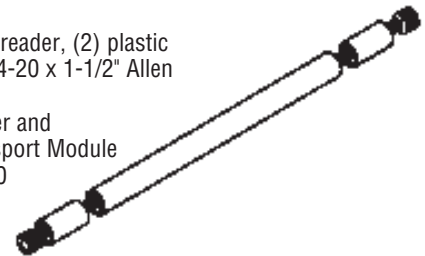

RPI Part #PHS008
OEM Part #874-081007

SPREADER ASSEMBLY

- Plastic
- Includes spreader, and (2) 1/4-20 x 5/8" stainless steel panhead screw

Fits: Developer, Fixer and Washer/Dryer Transport Module
Models: 810 & 9000

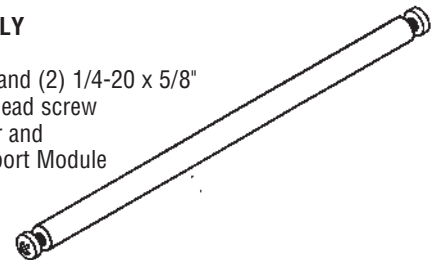

RPI Part #PHR025
OEM Part #874-060007

INGRESS ROLLER ASSEMBLY

- Plastic
- Includes stainless steel short middle knurl pin (RPI Part #PHP018), and ingress drive shaft assembly (RPI Part #PHA022)

Fits: Developer, Fixer and Washer/Dryer Transport Module
Models: 810 & 9000

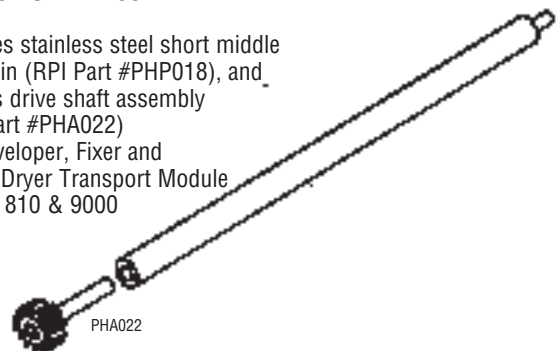

RPI is the best source for all your replacement parts.

Dental Equipment

Models: P4, P6 & P10

RPI Part #LIB001
New OEM Part #268-117
Old OEM Part #805-0016

DRIVE BELT (SHORT DRYER)

- 100 x L025 Timing Belt
- Effective belt length: 10"
- Belt width: 1/4"
- Grooves per inch: 5
- Pitch (measured from center line of tooth to center line of next tooth: 0.200

Fits: Dryer Rack
Models: P4, P6 & P10

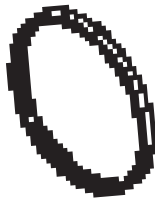

RPI Part #LIB002
New OEM Part #268-116
Old OEM Part #805-0017

MAIN DRIVE BELT

- 100 x L037 Timing Belt
- Effective belt length: 10"
- Belt width: 3/8"
- Grooves per inch: 5
- Pitch (measured from center line of tooth to center line of next tooth: 0.200

Fits: Main Drive System
Models: P4 & P6 only

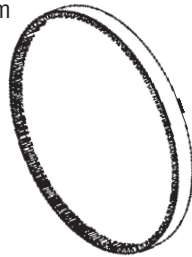

RPI Part #LIB003
New OEM Part #268-118
Old OEM Part #805-0019

DRIVE BELT

- 160 x L025 Timing Belt
- Effective belt length: 16"
- Belt width: 1/4"
- Grooves per inch: 5
- Pitch (measured from center line of tooth to center line of next tooth: 0.200

Fits: Dryer Rack
Models: P4, P6 & P10



BELT CHART	QTY. INDICATES NUMBER OF BELTS REQUIRED PER RACK					
	QTY	MODEL P4	QTY	MODEL P6	QTY	MODEL P10
Developer Rack	2	LIB004	2	LIB004	2	LIB004
Fixer Rack	1	LIO005	1	LIO005		
	2	LIB004	2	LIB004	2	LIB004
Washer Rack	2	LIB004	2	LIB004	2	LIB004
Dryer Rack	1	LIB003	1	LIB003	1	LIB003
	1	LIB001	1	LIB001	1	LIB001

RPI Part #LIB004
New OEM Part #268-119
Old OEM Part #805-0007

DRIVE BELT

- 170 x L025 Timing Belt
- Effective belt length: 17"
- Belt width: 1/4"
- Grooves per inch: 5
- Pitch (measured from C/L of tooth to C/L of next tooth: 0.200

Fits: Developer, Fixer, and Washer Racks
Models: P4, P6 & P10



RPI Part #LIO005
New OEM Part #268-120
Old OEM Part #805-0009
Industry Part #2-155

O-RING

- Material: Buna-N (Nitrile)
 - Hardness: 70 Duro
 - ID: 4.011, OD: 4.219, C/S: .104
- Fits:** Developer and Fixer Racks
Models: P4 & P6 only



O-Ring illustrations are actual size

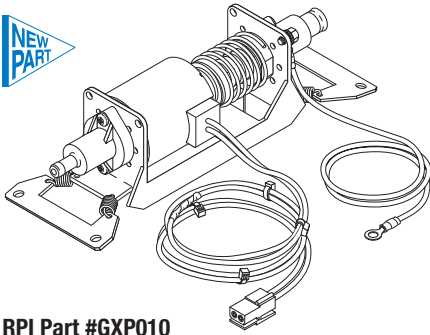

RPI Part #GXP010
OEM Part #112-0529G1

OSCILLATING PUMP

- 115VAC, .38 AMP, 25W
- 24" lead wires with connector
- Includes mounting brackets with springs
- Also available: Tubing (RPI Part #RPT652), Kwik™ Clamps (RPI Part #RPC637) and Silicone Gasket Maker 598 (RPI Part #RPS639)

Fits: Film Processor
Model: GXP

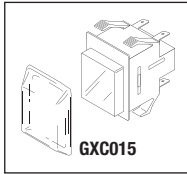

RPI Part #GXS013
OEM Part #632-0046P1

PUSH BUTTON SWITCH (WHITE)

- Run/Stand-by and On/Off Switches
- 3/16" quick connect tab
- DPST normally open
- 10A @ 125/250VAC
- Includes all parts as shown

Fits: Switch Panel
Model: GXP

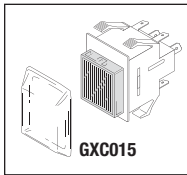

RPI Part #GXS014
OEM Part #632-0045P1

PUSH BUTTON SWITCH (RED)

- Illuminated Endo Switch
- 3/16" quick connect tab
- DPST normally open
- 10A @ 125/250VAC
- Includes all parts as shown

Fits: Switch Panel
Model: GXP



RPI Part #GXC015
OEM Part #433-0060P1

SWITCH COVER

- Transparent protective cover boot
 - Use with Push Button Switches (RPI Part #'s GXS013 & GXS014)
- Fits:** All Push Button Switches and Lamps
Model: GXP

RPI Part #GXB009
OEM Part #420-0007P1

DRIVE BELT

- 190XL025 Power Grip Timing Belt
- Effective belt length: 19"
- Belt width: .25"
- Grooves per inch: 5
- Pitch (measured from center line of tooth to center line of next tooth): .200"
- Number of teeth: 95

Fits: Developer, fixer, wash and dryer racks
Model: GXP

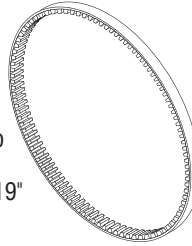

RPI Part #GXG007
OEM Part #303-0015P1

DRIVE GEAR

- Helical/pulley gear
- Material: Black Delrin®

Fits: Racks; Developer, Fixer and Wash
Model: GXP

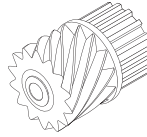

RPI Part #GXG008
OEM Part #112-0579G1

DRIVE GEAR

- Helical/pulley/spur gear
- Material: Black Delrin®

Fits: Dryer Racks
Model: GXP

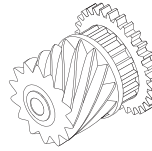

RPI Part #PHG009
OEM Part #303-0016P1 (White) & 303-0016P2 (Black)



GEAR

- 10 per package
- Material: White plastic
- 3/16" ID, 12 teeth
- This White Gear fits the Ideler Roller (5A #303-0016P1), and can also be used to replace the Black Gear that fits the Driver Roller (5B #303-0016P2)

Fits: Ideler Roller and Driver Roller
Model: GXP

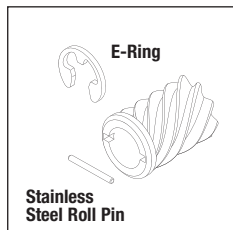
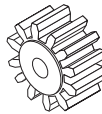

RPI Part #GXK006
OEM Part #112-0635G1

HELICAL GEAR KIT

- Gear material: Black Delrin®
- Includes all parts as shown

Fits: Drive Shaft
Model: GXP

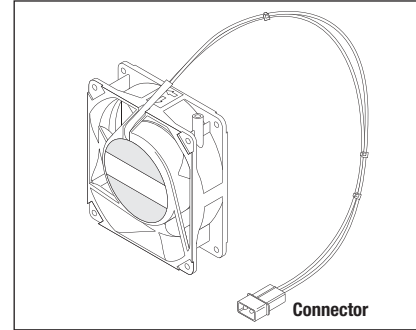

RPI Part #GXF011
OEM Part #122-0096G1

COOLING FAN

- 3.15" square x 1" wide
- 115VAC
- Airflow: 17-20 CFM
- Precision ball bearing
- Aluminum housing
- Includes all parts as shown

Fits: Back Panel
Model: GXP

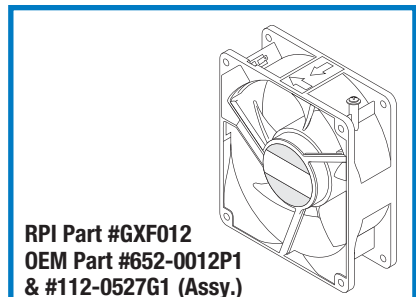

RPI Part #GXF012
OEM Part #652-0012P1 & #112-0527G1 (Assy.)

HEATER FAN

- 4.69" square x 1.5" wide
- 115VAC
- Airflow: 88-102 CFM
- Precision ball bearings
- Aluminum housing

Fits: Heater/Fan Assembly
Model: GXP

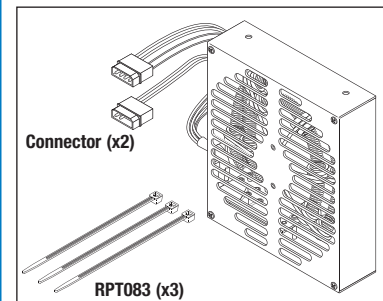

RPI Part #GXH039
OEM Part #112-0094G1 & #112-0527G1 (Assy.)

HEATER

- 4.68" square x 1.25" wide
- 120VAC, 750W
- Thermally protected
- Includes all parts as shown

Fits: Heater/Fan Assembly
Model: GXP

Dental Equipment

Model: GXP™

RPI Part #G XK041

OEM Part # (No OEM Part # Available)

MASTER TUBING KIT

- Includes (1 ea) of RPI Part #'s GXK026, GXK027, GXK028, GXK029, GXK030 and GXK031 – see details below.

Fits: Fluid Interface Assembly to Solution Container **Model: GXP**

INCLUDES ALL INLET & OUTLET TUBING KITS FOR A COMPLETE REBUILD!

Color Coded Spirals For Easy Identification!

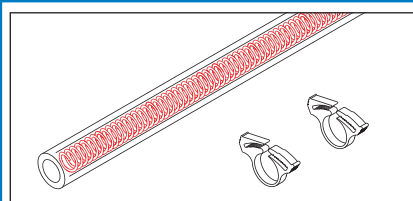
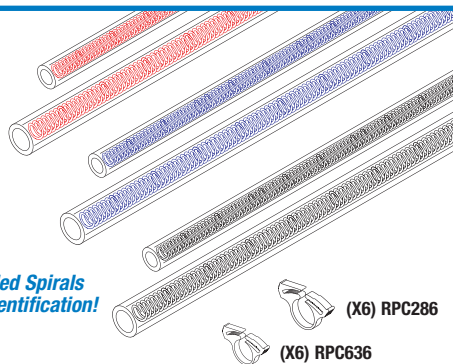

RPI Part #G XK026

OEM Part #112-0623G1

INLET TUBING KIT (RED)

- Includes 6' of 3/8" ID PVC Clear Tubing (RPI Part #RPT646), (2) 3/8" OD x 3' lg. Red Spiral Insert (RPI Part #GXS032) & (2) Kwik™ Clamp (RPI Part #RPC636)

Fits: Fluid Interface Assembly to Solution Container **Model: GXP**

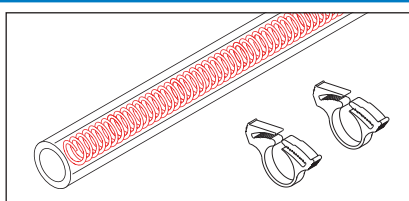

RPI Part #G XK029

OEM Part #112-0622G1

OUTLET TUBING KIT (RED)

- Includes 6' of 1/2" ID PVC Clear Tubing (RPI Part #RPT647), (2) 1/2" OD x 3' lg. Red Spiral Insert (RPI Part #GXS035) & (2) Kwik™ Clamp (RPI Part #RPC286)

Fits: Fluid Interface Assembly to Solution Container **Model: GXP**

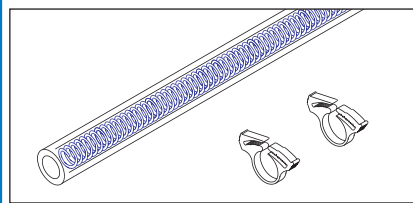

RPI Part #G XK027

OEM Part #112-0623G2

INLET TUBING KIT (BLUE)

- Includes 6' of 3/8" ID PVC Clear Tubing (RPI Part #RPT646), (2) 3/8" OD x 3' lg. Blue Spiral Insert (RPI Part #GXS033) & (2) Kwik™ Clamp (RPI Part #RPC636)

Fits: Fluid Interface Assembly to Solution Container **Model: GXP**

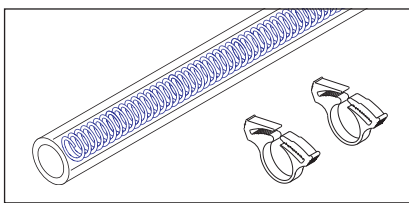

RPI Part #G XK030

OEM Part #112-0622G2

OUTLET TUBING KIT (BLUE)

- Includes 6' of 1/2" ID PVC Clear Tubing (RPI Part #RPT647), (2) 1/2" OD x 3' lg. Blue Spiral Insert (RPI Part #GXS036) & (2) Kwik™ Clamp (RPI Part #RPC286)

Fits: Fluid Interface Assembly to Solution Container **Model: GXP**

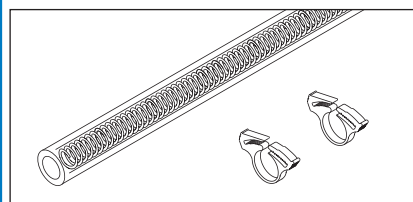

RPI Part #G XK028

OEM Part #112-0623G3

INLET TUBING KIT (CLEAR)

- Includes 6' of 3/8" ID PVC Clear Tubing (RPI Part #RPT646), (2) 3/8" OD x 3' lg. Black Spiral Insert (RPI Part #GXS034) & (2) Kwik™ Clamp (RPI Part #RPC636)

Fits: Fluid Interface Assembly to Solution Container **Model: GXP**

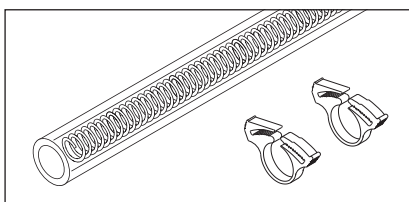

RPI Part #G XK031

OEM Part #112-0622G3

OUTLET TUBING KIT (CLEAR)

- Includes 6' of 1/2" ID PVC Clear Tubing (RPI Part #RPT647), (2) 1/2" OD x 3' lg. Black Spiral Insert (RPI Part #GXS037) & (2) Kwik™ Clamp (RPI Part #RPC286)

Fits: Fluid Interface Assembly to Solution Container **Model: GXP**

RPI Part #GXS032

OEM Part # (No OEM Part # Available)

SPIRAL INSERT (RED 3/8" OD)

- Material: PVC; Color: Red
- Fits: Inlet Tubing **Model: GXP**

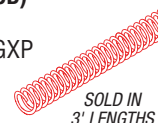

RPI Part #GXS035

OEM Part # (No OEM Part # Available)

SPIRAL INSERT (RED 1/2" OD)

- Material: PVC; Color: Red
- Fits: Outlet Tubing **Model: GXP**

RPI Part #GXS033

OEM Part # (No OEM Part # Available)

SPIRAL INSERT (BLUE 3/8" OD)

- Material: PVC; Color: Blue
- Fits: Inlet Tubing **Model: GXP**

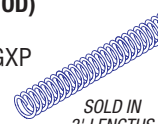

RPI Part #GXS036

OEM Part # (No OEM Part # Available)

SPIRAL INSERT (BLUE 1/2" OD)

- Material: PVC; Color: Blue
- Fits: Outlet Tubing **Model: GXP**

RPI Part #GXS034

OEM Part #407-0156P1

SPIRAL INSERT (BLACK 3/8" OD)

- Material: PVC; Color: Black
- Fits: Inlet Tubing **Model: GXP**

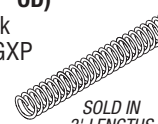

RPI Part #GXS037

OEM Part #407-0156P2

SPIRAL INSERT (BLACK 1/2" OD)

- Material: PVC; Color: Black
- Fits: Outlet Tubing **Model: GXP**

RPI Part #RPC286

OEM Part #407-0159P5

KWIK™ CLAMP (6/pkg)

- Clamping Range: 11/16" - 13/16" (.688" - .812")
- Fits: 11/16" OD Tubing **Model: GXP**



RPI Part #RPC636

OEM Part #407-0159P2

KWIK™ CLAMPS (6/pkg)

- Clamping Range: 15/32" - 17/32" (.468"-.594")
- Fits: 1/2" OD Tubing **Model: GXP**

Nylon (White)

RPI Part #RPT646

OEM Part # (No OEM Part # Available)

TUBING (CLEAR 3/8" ID PVC)

- 3/8" ID x 1/2" OD; Sold by the foot
- Fits: Inlet Fitting **Model: GXP**

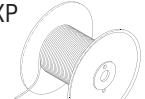

RPI Part #RPT647

OEM Part # (No OEM Part # Available)

TUBING (CLEAR 1/2" ID PVC)

- 1/2" ID x 11/16" OD; Sold by the foot
- Fits: Outlet Fittings and Internal Pump Connections **Model: GXP**

Does not include reel

RPI Part #GXM002
OEM Part #112-0534G1

DRIVE MOTOR

- 1/30 Hp, 90VDC, 25 RPM
- Includes all parts as shown

Fits: Drive Motor
Model: GXP

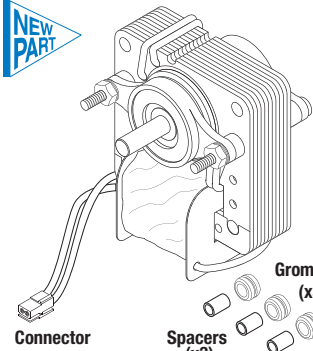
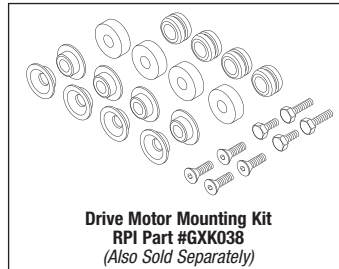
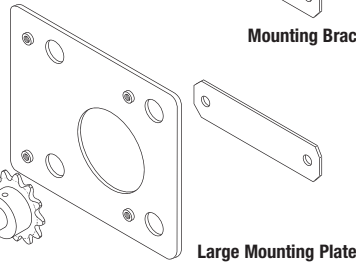
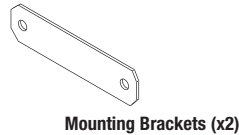
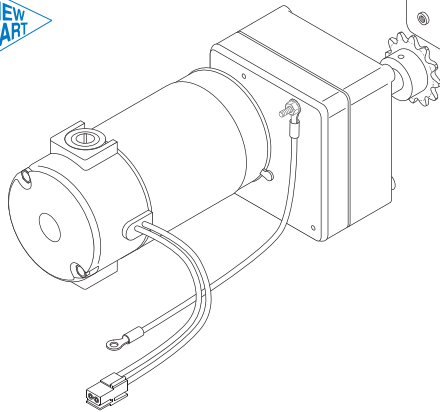

RPI Part #GXM023
OEM Part #112-0531G1

AGITATOR MOTOR

- 120VAC, 60 Hz., 3000 RPM
- Impedance protected
- 1/4" dia. shaft; 3/4" lg.
- Sealed ball bearings
- Includes all parts as shown

Fits: Agitator Assembly (Bottom Tanks)
Model: GXP



RPI Part #G XK038
OEM Part # (OEM Part # Not Available)

DRIVE MOTOR MOUNTING KIT

- Includes all parts as shown

Fits: Drive Motor
Model: GXP

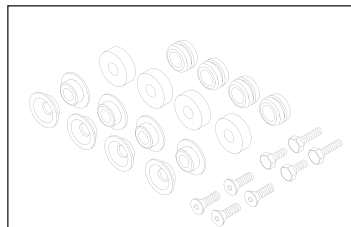

- Includes:**
- (2) #10-32 x 1/2" Hex Head Screws
 - (2) #10-32 x 3/4" Hex Head Screws
 - (4) #10-32 x 3/4" Flat Head Screws
 - (4) Screw Retainer Top
 - (4) Screw Retainer Bottom
 - (4) Grommets
 - (4) Spacers

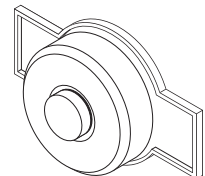

RPI Part #GXA025
OEM Part #112-0563G1

SOLUTION AGITATOR

- Magnetic material
 - Includes all parts as shown
- Fits:** Solution Tank
Model: GXP

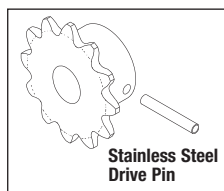

RPI Part #GXS003
OEM Part #303-0042P1

SPROCKET

- Dark grey glass filled nylon
- 12 tooth
- 1.08" OD
- 5/16" bore
- For #25 (1/4" pitch) Roller Chain
- Includes all parts as shown

Fits: Main Drive Motor
Model: GXP

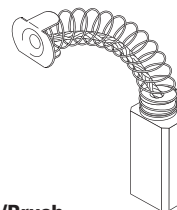

RPI Part #GXB004
OEM Part #652-0015P1/Brush

MOTOR BRUSH

- 2 per package
- .187" x .312" x .625"
- Radius: 1/2"
- Spring length: .88"
- Copper shunt wire
- Cap sold separately (RPI Part #RPC038)

Fits: Brush Holder Assembly On
Main Drive Motor

Model: GXP



RPI Part #RPC038
OEM Part #652-0015P1/Cap

BRUSH CAP

- 6 per package
- Material: Bakelite
- 1/2-27 thread
- Brush sold separately (RPI Part #GXB004)

Fits: Main Drive Motor
Model: GXP

Dental Equipment

Model: GXP™

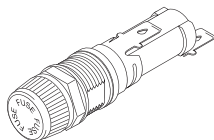

RPI Part #RPH638
OEM Part # 646-0047P1

FUSE HOLDER (MAIN)

- 3/16" quick connect tabs
- Fits standard 1/4" x 1-1/4" fuse
- 20A @ 250VAC
- Includes mounting hardware

Fits: Rear Panel
Model: GXP

RPI Part #RPF070
OEM Part #646-0048P1

FUSE (MAIN) (12A, 250VAC)

- 5 per package
- Type: Ceramic; MDA Time Delay
- Size: 1/4" x 1-1/4"

Fits: Fuse Holder (Main)
Model: GXP

RPI Part #RPF045
OEM Part #646-0054P16

FUSE (1A, 250VAC)

- 5 per package
- Type: Glass; AGC Fast Acting
- Size: 1/4" x 1-1/4"

Fits: PC Board Position: F1
Model: GXP

RPI Part #RPF046
OEM Part #46-170021P34

FUSE (1-1/2A, 250VAC)

- 5 per package
- Type: Glass; AGC Fast Acting
- Size: 1/4" x 1-1/4"

Fits: PC Board Position: F2
Model: GXP

RPI Part #RPF053
OEM Part #46-170021P33

FUSE (8A, 250VAC)

- 5 per package
- Type: Glass; AGC Fast Acting
- Size: 1/4" x 1-1/4"

Fits: PC Board Position: F3
Model: GXP

RPI Part #RPF512
OEM Part # (No OEM # Available)

FUSE (1A, 250VAC)

- 5 per package
- Type: Glass; Fast Acting
- Size: 5mm x 20 mm

Fits: PC Board Position: F4
Model: GXP

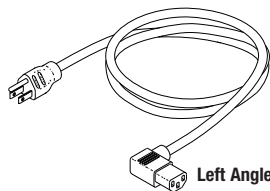

Left Angle Plug

RPI Part #RPC291
OEM Part #644-0009P1

INDUSTRIAL GRADE POWER CORD

- Length: 6 ft.
- 14/3 SJT, 105°C; 15A @ 125VAC
- NEMA 5-15P; EN60320-C13L Left Angle

Model: GXP

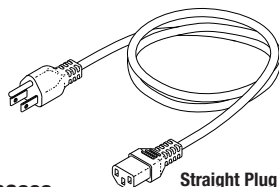

Straight Plug

RPI Part #RPC262
OEM Part # (No OEM # Available)

INDUSTRIAL GRADE POWER CORD

- Length: 10 ft.
- 14/3 SJT, 60°C; 15A @ 125VAC
- NEMA 5-15P; EN60320-C13

Model: GXP



RPI Part #RPC637
OEM Part #407-0159P1

KWIK™ CLAMPS (6/pkg)

- Material: Nylon; Color: White
- Clamping Range: 23/64" - 25/64" (.359" - .390")

Fits: 3/8" OD Tubing (Pump Tubing)
Model: GXP

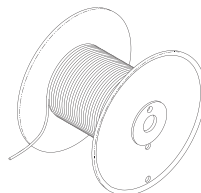

RPI Part #RPT652
OEM Part #273-0010P1

TUBING (1/4" TYGON®)

- Pump tubing
- 1/4" ID x 3/8" OD
- Black
- Sold by the foot (Does not include reel)

Fits: Pump and Pump Connections
Model: GXP



RPI Part #RPS639
OEM Part # (No OEM # Available)

SILICONE GASKET MAKER 598

- 5 per package
- .05 fl. oz. per unit
- Material: RTV Black Silicone
- Provides a sealant for the pump tubing connections

Model: GXP

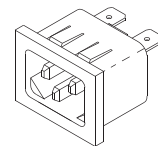

RPI Part #HBM011
OEM Part #651-0068P1

POWER MODULE

- 15A @ 250VAC
- 1/4" quick connect tabs

Fits: Rear Panel
Model: GXP

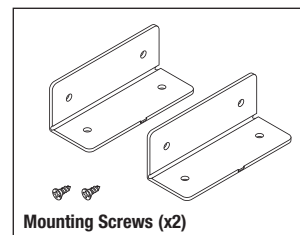

Mounting Screws (x2)

RPI Part #GXK040
OEM Part #406-0015P1

HINGE KIT

- 1-1/2" x 2"
- Plastic hinge (white)
- Includes all parts as shown

Fits: Upper Cover to Bottom Frame
Model: GXP

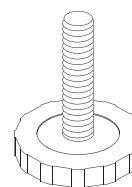

RPI Part #GXF024
OEM Part #112-0629G1

LEVELING FOOT

- 4 per package
- 1.50" dia. non-skid PVC base
- 3/8-16 x 1-1/4" lg. stainless steel stud

Fits: Bottom Frame
Model: GXP



Actual Size

RPI Part #RPO360
OEM Part #404-0036P2
Industry Part #AS568-011

O-RING

- 6 per package
- .301" ID x .441" OD x .070" C/S
- Material: EPDM
- Duro: 80

Fits: Standpipe
Model: GXP

RPI Part #AMB028
OEM Part #93-90-029

LIGHT BULB

- Standard NE51 bulb
- Fits:** Light socket
- Models:** 660 & Mark III



RPI Part #AIS034
OEM Part # N/A

LIGHT SOCKET

- 120V
- Accommodates standard NE51 bulb
- Uses lens caps (RPI Part #AIC035--AIC044)
- Fits:** Front panel
- Model:** 660 & Mark III

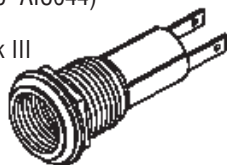

RPI Part #AIC035
OEM Part #93-90-330

LENS CAP (RED)

- Fits:** Light socket
- Model:** 660 & Mark III



RPI Part #AIC036
OEM Part #93-90-329

LENS CAP (WHITE)

- Fits:** Light socket
- Model:** 660 & Mark III



RPI Part #PCL027
OEM Part # N/A

"POWER ON" LIGHT (RED)

- Includes light, and (2) quick disconnect (.250 female tab, 18-14 AWG)

Fits: Front panel
Model: 650 & Mark II

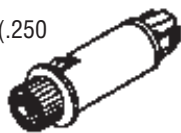

RPI Part #PCL028
OEM Part # N/A

"HEAT ON" LIGHT (AMBER)

- Includes light, and (2) quick disconnect (.187 female tab, 22 x 16 AWG)

Fits: Front panel
Model: 650 & Mark II



RPI Part #RCB096
OEM Part #93-90-065

BUZZER

- 120 Volt, 60 Hz, .05 Amps
- 6" wire leads with 1/4" quick disconnect terminals
- Fits:** Chassis/Control Module
- Models:** All ovens

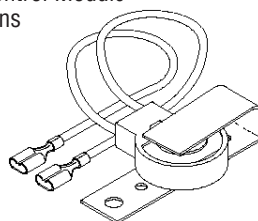

RPI Part #MDT012
OEM Part # N/A

TIMER WITH BELL

- 60 minute mechanical timer
- Includes timer, face plate, and mounting nut
- Fits:** Chassis
- Models:** Mark II

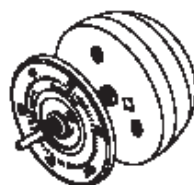

RPI Part #MDK018
OEM Part # N/A

VACUUM CONTROL KNOB

- Fits:** Vacuum valve shaft
- Models:** 660, Mark III & Mark IV
- (New style valve only)

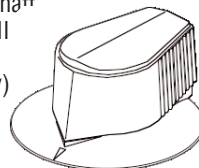

RPI Part #BUK042
OEM Part # N/A

TEMPERATURE ADJUSTMENT KNOB

- Fits:** Pyrometer shaft
- Models:** 650, 660, Mark II, Mark III on older meters only



RPI Part #PCS133
OEM Part # N/A

CASING SCREW

- 12 per package
- 10-24 x 3/8
- Slotted binder head
- Stainless steel
- Fits:** Speednut
- Models:** All ovens



RPI Part #PCN136
OEM Part # N/A

SPEEDNUT

- 10 per package
- "U" type 10-24 thread
- Fits:** Chassis
- Models:** All ovens



RPI Part #ADS129
OEM Part # N/A

POWER SWITCH (VACUUM PUMP SWITCH)

- SPST
- 20A, 125VAC; 10A 250VAC
- Includes (2) Pig Tail (RPI Part #RPT014)
- Fits:** Vacuum chamber assembly
- Model:** 650 & Mark II

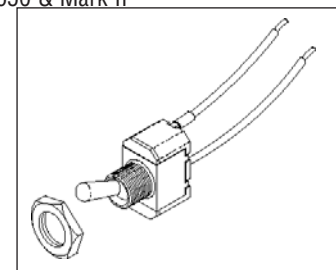

RPI Part #PCC004
OEM Part #93-90-401

POWER CORD WITHOUT CONNECTORS

- 8 ft.
- Rated: 16 AWG
- 3 conductor
- Type: HSJO (90°C heater cord)
- Fits:** Back panel
- Models:** All ovens

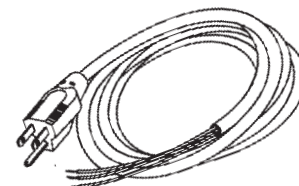

RPI guarantees your satisfaction with every part you order!

Dental Equipment

Porcelain Ovens - Ney Dental *(continued)*

Model: 650, 660, Mark II, Mark III & Mark IV

RPI Part #RPB159
OEM Part #93-90-361

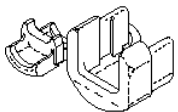

STRAIN RELIEF BUSHING

- 6 per package
- UL/CSA Type SR-7P-2
- Wall or panel thickness 1/8" maximum
- AWG/Conductors 18/2-18/3, 16/2-16/3
- Mounting hole diameter 3/4"
- Also in Strain Relief Bushing Kit (RPI Part #RPK412)

Fits: Back panel
Models: All ovens

RPI Part #RPT172

STRAIN RELIEF BUSHING PLIERS

- Hand pliers adjustable for all bushings that assemble into to 7/

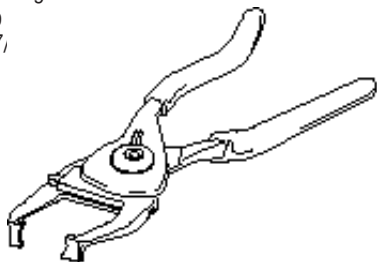

RPI Part #RP0315
OEM Part # N/A
Industry Part #2-009



O-RING

- 12 per package
 - Material: Buna-N (Nitrile)
 - Hardness: 70 Duro
 - ID: .208, OD: .348, C/S: .070
- Fits:** Vacuum Valve Stem
Models: All ovens

New RPI Part #RP0303
OEM Part # N/A
Industry Part #2-012

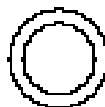

O-RING

- 12 per package
 - Material: Buna-N (Nitrile)
 - Hardness: 70 Duro
 - ID: .364, OD: .504, C/S: .070
- Fits:** Vacuum Valve Stem
Models: All ovens

RPI Part #RPA032

THREADLOCKER 242

- 5 per package
- .02 FL. OZ per unit
- Prevents rust and corrosion
- Removable adhesive by Loctite®



RPI Part #RPW086

HIGH TEMPERATURE WIRE (WHITE)

- Sold by the foot
 - Teflon® insulated
 - Type EE, 1000V
 - Maximum operating temperature 200°C
- Fits:** Muffle leads to plug
Models: All ovens



DON'T FORGET!

RPI Part #RPL090

HIGH TEMP LUBRICANT

- 5 per package
- 1/2 gram each package
- **Non-silicone** lubricant
- Temperature range: -40°F to +400°F

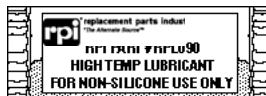

See GENERAL SHOP AIDS section for High Temperature Wire in other gauges and colors.

RPI is name you can trust for quality parts - We Guarantee It!

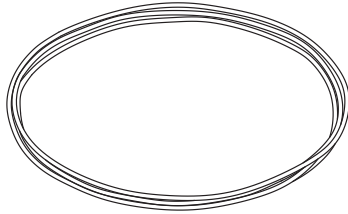

RPI Part #WLB002
OEM Part #AS404

BELT (6' 6")

- Material: Pyrrathane
 - Size: .093" dia. C/S x 6' 6" circumference
- Models:** Arms: AS051 (Whisper short arm) and Arms: AS011 (Piccolo engine arm)

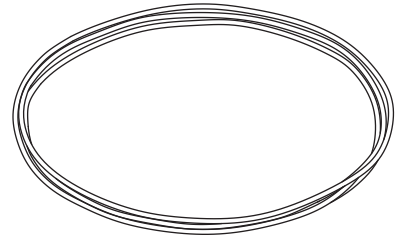

RPI Part #WLB003
OEM Part #AS406

BELT (9' 8")

- Material: Pyrrathane
 - Size: .093" dia. C/S x 9' 8" circumference
- Models:** Arms: AS052 (Whisper long arm) and Arms: AS012 (Standard engine arm)

RPI Part #PCC004
OEM Part # (No OEM Part # Available)

POWER CORD WITHOUT CONNECTORS

- Length: 8 ft.; Color: Black
- 16/3; 105°C; 13A @ 125VAC
- Plug Type: NEMA 5-15P
- Connector Type: None; 0.33" OD Cord
- Service Tip: When replacing power cord, use a new Strain Relief Bushing (RPI Part #RPB164)

Fits: Motor Hood
Models: Hood & Motor: E026, E027, E028 & E029

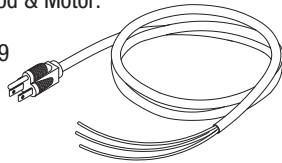

RPI Part #RPB164
OEM Part # (No OEM Part # Available)

STRAIN RELIEF BUSHING

- 8 per package
- Type: SR-6N3-4
- Mounting Hole: 5/8" x 1/8" THK max.
- Cord Type: .325" - .360" round cable
- Use when replacing power cord (RPI Part #PCC004)
- Also included in: Strain Relief Bushing Kit (RPI Part #RPK412)

Fits: Motor Hood
Models: Hood & Motor: E026, E027, E028 & E029

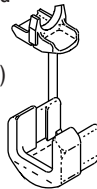

RPI Part #RPT172
OEM Part # (No OEM Part # Available)

STRAIN RELIEF BUSHING PLIERS

- Hand pliers adjustable for all bushings that assemble into mounting hole up to 7/8" diameter
 - Size: ~ 7" lg.
- Models:** Hood & Motor: E026, E027, E028 & E029

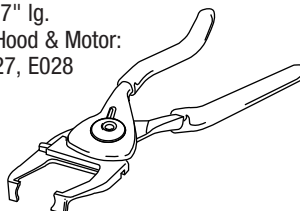

RPI Part #CAF011
OEM Part # (No OEM Part # Available)

RUBBER FOOT

- 4 per package
- Material: Black rubber with molded in steel washer
- Size: ~ .750" O.D. x .50" lg.; #10 clearance hole

Fits: Foot Control and Hood
Models: Hood & Motor: E026, E027, E028 & E029 and Foot Controls: F011 & F013



RPI Part #RPT017
OEM Part # (No OEM Part # Available)

WIRE NUT

- 15 per package
- Range: #22-#16 AWG (Gray)
- Also included in: Crimp-On Wire Connector & Wire Nut Kit (RPI Part #RPK401)

Models: Hood & Motor: E026, E027, E028 & E029

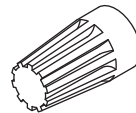

RPI Part #RPF051
OEM Part # (No OEM Part # Available)

FUSE (5A, 250V)

- 5 per package
 - Type: AGC Glass, Fast-Acting
 - Size: 1/4" dia. x 1-1/4" lg.
 - Also included in: Fuse Kit (Fast-Acting) (RPI Part #RPK410)
- Fits:** Foot Control Fuse Holder
Models: Foot Controls: F011 & F013

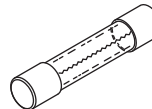

RPI Part #WLB001
OEM Part #E-101



BRUSH

- 2 per package
- Size: .125" x .187" x .596" lg.
- Radius: .470"
- Spring Length: .75"
- Copper shunt wire

Models: Hood & Motor: E026, E027, E028 & E029 and Motor: Baldor - E132 & E133

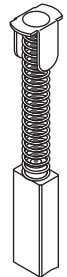

RPI Part #DRB001
OEM Part #E-105

BRUSH

- 2 per package
- Size: .250" x .375" x .817" lg.
- Radius: .625"
- Spring length: 1.375"

Models: Hood & Motor: E026, E027, E028 & E029 and Motor: Bodine (Large brush) - E-131

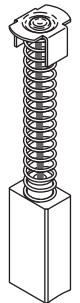

RPI Part #BDB001
OEM Part #E-107

BRUSH

- 2 per package
- Size: .250" x .187" x .650" lg.
- Radius: None
- Spring Length: 1.100"
- MFG 1983-1987

Models: Hood & Motor: E026, E027, E028 & E029 and Motor: Bodine (Small brush) - E-129 & E-130

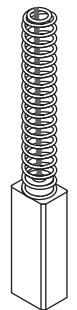

RPI Part #EMB001
OEM Part #E-106

BRUSH

- 2 per package
- Size: .250" x .250" x .657" lg.
- Radius: .500"
- Spring Length: 1.343"

Models: Hood & Motor: E026, E027, E028 & E029 and Motor: WSM

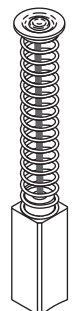

Dental Equipment

Ray Foster Dental Equipment

Model: 10" & 12" Trimmer

RPI Part #ADS129
OEM Part #M081

POWER SWITCH

- SPST
 - 20A @ 125VAC; 12A @ 250VAC
 - Includes all parts as shown
- Fits:** Motor, Switch Cover Plate
Model: All models

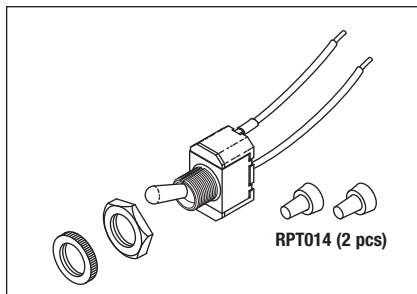

RPI Part #PCF179
OEM Part # (No OEM Part # Available)

RUBBER FOOT ASSEMBLY

- 2 per package
- Includes all parts as shown

Fits: Lower Frame
Models: All models

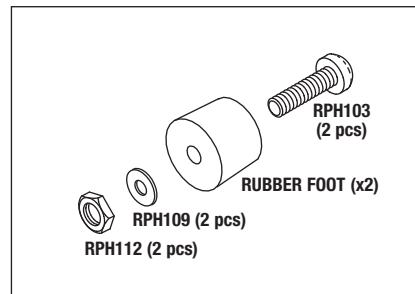

Whip Mix

Model: Vac-U-Vester

RPI Part #ADS129
OEM Part #M081

POWER SWITCH

- SPST
 - 20A @ 125VAC; 12A @ 250VAC
 - Includes all parts as shown
- Fits:** Housing
Model: D

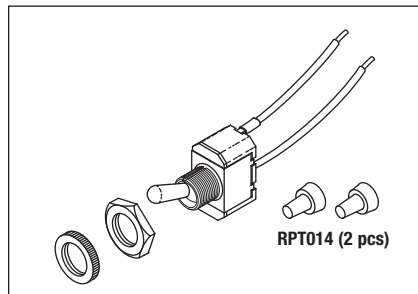

RPI Part #PCF179
OEM Part # (No OEM Part # Available)

RUBBER FOOT ASSEMBLY

- 2 per package
 - Includes all parts as shown
- Fits:** Bottom plate assembly
Models: Table top models

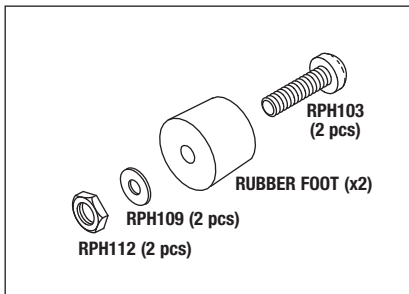

RPI Part #GOL022
OEM Part # (No OEM Part # Available)

ROTARY PUMP OIL

- 4 fl. oz.
 - Includes yorker spout
 - ISO68
 - For MSDS, see RPI website
- Fits:** All Rotary Pumps (dispenses into oil reservoir)

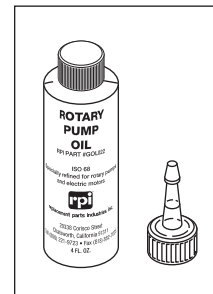

RPI Part #PCC004
OEM Part #6001C

POWER CORD WITHOUT CONNECTORS

- Length: 8 ft.; Color: Black
- 16/3; 105°C; 13A @ 125VAC
- Plug Type: NEMA 5-15P
- Connector Type: None; 0.33" OD Cord
- Service Tip: When replacing power cord, use a new Strain Relief Bushing (RPI Part #RPB159)

Fits: Motor pump
Models: All models

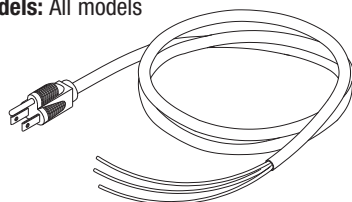

RPI Part #RPB159
OEM Part #6206

STRAIN RELIEF BUSHING

- 6 per package
- Type: SR-7P-2
- Mounting hole: 3/4" x .125 THK max.
- Cord type: .360" x .430" round cable
- Also included in: Strain Relief Bushing Kit (RPI Part #RPK412)

Fits: Motor pump
Model: D combination unit

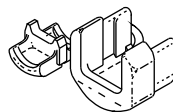

RPI Part #RPT172
OEM Part # (No OEM Part # Available)

STRAIN RELIEF BUSHING PLIERS

- Hand pliers adjustable for all bushings that assemble into mounting hole up to 7/8" diameter
- Size: ~ 7" lg.

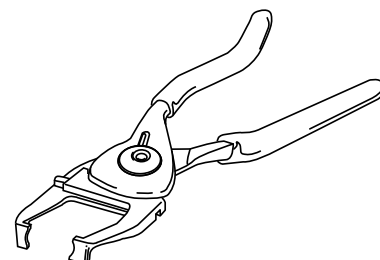

RPI Part #LMP604
Industry Part #ENZ

LAMP

- 30V, 50W
- Base: 2-pin
- Models:** EFOS Lite, Henry Schein, Kinetic Instrument Sunspot, L.D. Caulk (Prisma-Lite), MDT (Rolux II), Proden Executor, S.S. White Profile Curing Lite & Teledyne Getz Focus

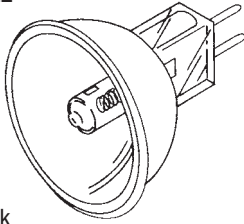

RPI Part #LMP605
Industry Part #ETJ

LAMP

- 120V, 250W
- Base: 2-pin, special
- Models:** Chapman Huffman, Midwest (Insight I & II), Kavo (Curing Light), Healthco (VCL Illum.), Lares (Quartz Fire SX) & Vicon (LS, DLS, Polor II)

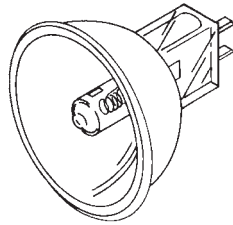

RPI Part #LMP606
Industry Part #ELZ

LAMP

- 21V, 150W
- Base: 2-pin
- Models:** Midwest (Oral Illuminator II & III)

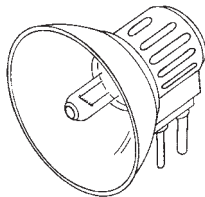

RPI Part #LMP603
Industry Part #EJL

LAMP

- 24V, 200W
- Base: 2-pin
- Models:** Caulk (Prisma) & MDT (Rolux I)

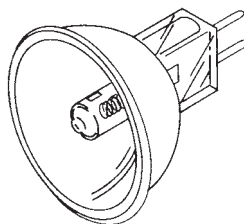

RPI Part #LMP600
Industry Part #FCS

LAMP

- 24V, 150W
- Base: 2-pin
- Also available: Socket (RPI Part #ADS125) to fit A-dec
- Models:** Faro (original unit Sunlight 70), Eurodent & J. Morita



RPI Part #LMP609
OEM Part #041.709.00/041.179.00/041.179.01/28.1004.00 (Bulb & Holder only)

LAMP (17V, 95W)

- Halogen Bulb
- G6.35 2-Pin base
- Also available: Lamp Socket Assembly (RPI Part #ADS125)
- Fits:** Light Socket Assembly
- Models:** A-dec 6300 Series



RPI Part #LMP601
Industry Part #H-3

LAMP

- 12V, 55W
- PK22S base style with 1/4" quick connect tab
- Halogen
- Also available: Socket (RPI Part #BES012) to fit Belmont X-Calibur
- Models:** A-dec Performer, Belmont X-Calibur Models 040, 046, 047 & 048, Chayes Light, Fiad (The Light) & Healthco Aristocrat and X-Calibur

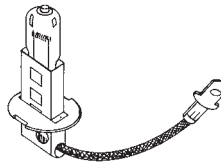

RPI Part #LMP026
OEM Part #501074

LAMP

- 24 VDC, 60W
- PK22S base style with 1/4" quick connect tab
- Black tip on bulb
- Halogen
- Models:** Belmont Clesta 501, 502 & 505



RPI Part #LMP602
Industry Part #125T10/P

LAMP

- 120V, 125W
- Base: Medium, prefocus
- Models:** Castle (Panavision)



RPI Part #LMP607
Industry Part #FDS/DZE

LAMP

- 24V, 150W
- Base: 2-pin
- Models:** Ritter (Knight, "K" Super Starlite), Faro (Koolbeam, Sunlight S-90 & 70 upgrade) Henry Schein Starbrite, Marus Starbrite & Porter Daystar S-90B

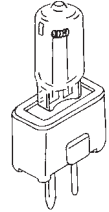

RPI Part #LMP608
Industry Part #75T3Q/CL; 075/CL/DC-28

LAMP

- 28V, 75W
- Base: Double contact, bayonet
- Halogen
- Models:** Ritter "J" (Starlite)

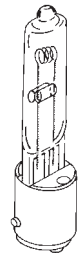

RPI Part #AMB028
Industry Part #NE51

LIGHT BULB

- T-3-1/4 mini bayonet
- 120V, .3ma
- Also available: Light Socket (RPI Part #AIS034), Lens Cap (Red) (RPI Part #AIC035), Lens Cap (White) (RPI Part #AIC036) & Lens Cap (Amber) (RPI Part #AIC037)
- Fits:** Panel Light Sockets
- Models:** Aristocrat (1022), Dynaclave 613R (576A), 8816A, 8816M (608A), Ney Dental Porcelain Ovens (660 & Mark III) & Volt/Matt

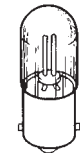

RPI Part #PCL606
Industry Part #150T4Q/CL25V
P&C OEM #3321879 (017133)

LAMP

- 25V, 150W
- Base: Double ended
- Halogen
- Also available: Sockets (RPI Part #'s PCS605 & PCS607) and Socket Retractor Tool (RPI Part #PCT685) to fit Pelton & Crane
- Models:** All Pelton & Crane LF, LF+, LFII, LFIII, LFIIS & LFIISE

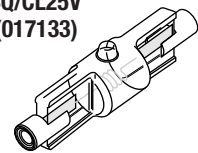

RPI Part #PCT685
P&C OEM #006800

SOCKET RETRACTOR TOOL

- Size: ~ 3-1/4" lg.
- For installation of Lamp (RPI Part #PCL606)
- Models:** Pelton & Crane LFI & LF+

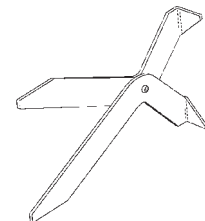

RPI Part #ADL126
OEM Part #28-0503-01

LENS SPLASH SHIELD

- Clear plastic
- Mounting hardware not included

Fits: Light head

Models: 6300 Series

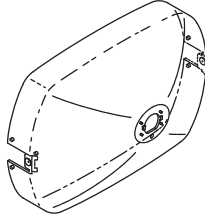

RPI Part #ADR185
OEM Part # (No OEM Part # Available)

REFLECTOR

- New glass - Not Re-coated
- Includes all parts as shown

Fits: Light head

Models: 6300 Series

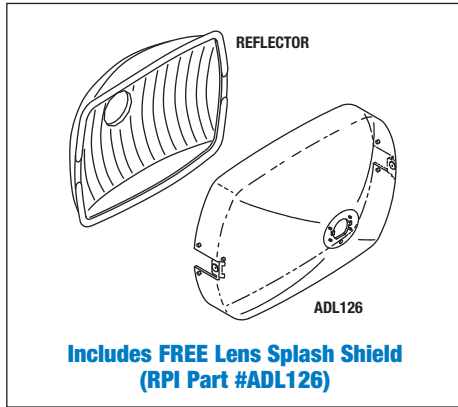

NEW KIT
All Parts Also Sold Separately

RPI Part #ADK269
OEM Part #28.0503.02

LENS KIT

- Includes all parts as shown
- All parts sold separately
- Also available: Lever & Bracket Kit (RPI Part #ADK274)

Fits: Lens Assembly
Models: 6300 Series

RPI PART #	OEM PART #	DESCRIPTION	MATERIAL	QTY PER PACKAGE
ADL126	28-0503-01	Lens Splash Shield	Clear Plastic	1
ADN273	75.007.00 & 28.0504.00	Nosepiece	Plastic	1
ADP271	28.0554.00	Mount Plate (Lamp Shield) • Includes: Mounting Screw	Plastic	1
ADP272	28.0553.00	Mount Plate (Nosepiece) • Includes: Mounting Screw	Plastic	1
ADS270	28.0555.00	Lamp Shield • Includes: (2) Mounting Screws	Flat Black Steel	1

RPI Part #ADK258
OEM Part #28.0770.00 (Bearing Sleeve only)/**018.063.00** (Black Hole Plug only)/**28.1536.00** (Surf Hole Plug only)

PIVOT TENSION KIT

- Includes all parts as shown
- All parts sold separately

Fits: Yoke Assembly

Models: 6300 Series

***Note:** The assembly order of the parts included in our Pivot Tension Kit vary dramatically depending upon the Light Head. The Light Heads will use all or some of the parts included in our Pivot Tension Kit.*

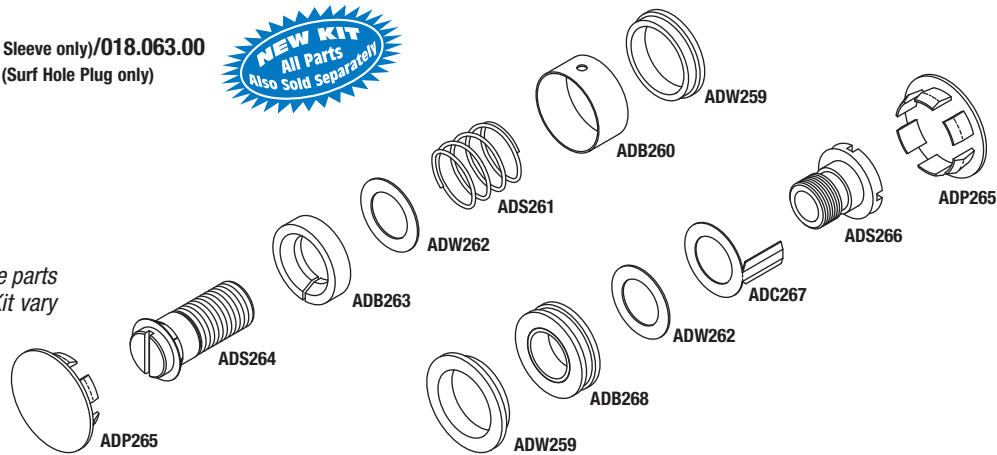

RPI PART #	OEM PART #	DESCRIPTION	MATERIAL	KIT QUANTITY	REORDER QUANTITY
ADB260	28.0770.00	Bearing Sleeve	Nickel Plated Brass	1	1
ADB263	No OEM Part # Available	Bushing (Right)	White Plastic	1	1
ADB268	No OEM Part # Available	Bushing (Left)	White Plastic Sleeve & Brass Bushing	1	1
ADC267	No OEM Part # Available	Ground Contact	Copper	1	1
ADP265	018.063.00 (Black) & 28.1536.00 (Surf)	Hole Plug	Off-White Plastic	2	2
ADS261	No OEM Part # Available	Spring	Music Wire	1	1
ADS264	No OEM Part # Available	Screw (Tension Adj. Right)	Brass	1	1
ADS266	No OEM Part # Available	Screw (Tension Adj. Left)	Brass	1	1
ADW259	No OEM Part # Available	Washer (Sleeve)	White Plastic	2	1
ADW262	No OEM Part # Available	Flat Washer	White Plastic	2	1

Call Us Toll-Free Monday-Friday, 8:00 AM-4:30 PM (Pacific Time), (800) 221-9723

Dental Equipment

Models: 6300 Series

RPI Part #ADK274
OEM Part #28.1012.00 Surf/
28.0643.00 (Black)



LEVER & BRACKET KIT

- 2 per package
- Color: Gray
- Fits:** Lens Assembly
- Models:** 6300 Series

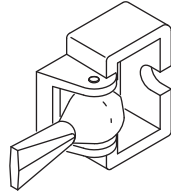

RPI Part #ADS125
OEM Part #28-0633-00

LAMP SOCKET ASSEMBLY

- Includes all parts as shown
- Also available: Lamp (RPI Part #LMP609)
- Fits:** Inside of Focus Tube
- Models:** 6300 Series

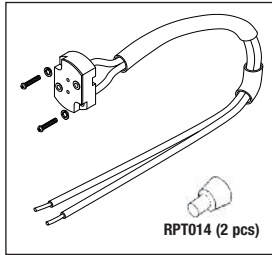

RPI Part #LMP609
OEM Part #041.709.00/041.179.00/
041.179.01/28.1004.00 (Bulb & Holder only)

LAMP (17V, 95W)

- Halogen Bulb
- G6.35 2-Pin base
- Also available: Lamp Socket Assembly (RPI Part #ADS125)
- Fits:** Light Socket Assembly
- Models:** 6300 Series



RPI Part #ADT127
OEM Part #28-0566-00

LOCKING TAB

- Material: Oilite bronze
- Fits:** Pivot Arm to Mounting Hub
- Model:** 6300 Series



RPI Part #ADK275
OEM Part #28.0628.00 (Handle only)/
28.0629.00 (Handle only)



HANDLE INSERT KIT

- 2 per package
- Material: Plastic
- Includes all parts as shown
- Fits:** Handles
- Models:** 6300 Series

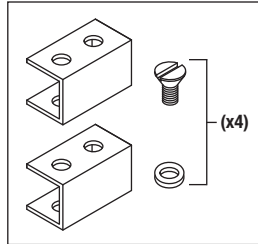

RPI Part #ADS129
OEM Part #041-336-00/90.1039.00

POWER SWITCH

- Toggle switch
- 20A @ 125VAC; 10A @ 250VAC; SPST
- Includes all parts as shown
- Fits:** Head Assembly and Swivel Block
- Models:** 6300 Series

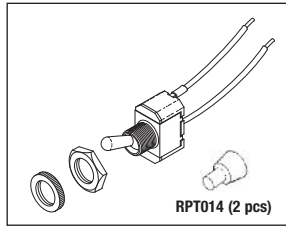

RPI Part #ADS130
OEM Part #041-177-00

INTENSITY SWITCH

- Toggle switch
- 6A @ 125VAC; 3A @ 250VAC
- On-On-On; DPDT; .093" Tabs
- Includes: Mounting hardware
- Fits:** Transformer Housing, Box Assembly and Pivot Arm Assembly
- Models:** 6300 Series

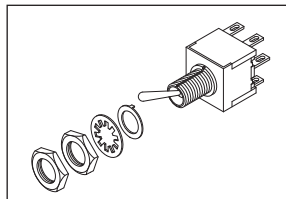

RPI Part #RPH243
OEM Part #046-123-000

CIRCUIT BREAKER

- 10A @ 250VAC
- Includes all parts as shown
- Manual reset
- Fits:** Transformer Housing of Ceiling, Wall, Unit and Track Assembly
- Models:** 6300 Series

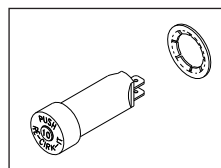

RPI Part #ADT132
OEM Part #28-0724-00/90.1041.00

TRANSFORMER

- 120/240V, 50/60Hz
- Includes all parts as shown
- Fits:** Preference II, Box Assembly
- Models:** 6300 Series

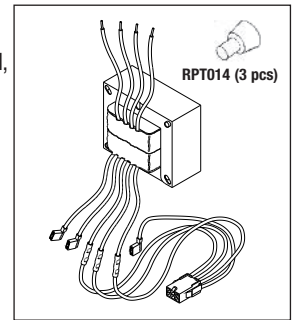

RPI Part #ADT133
OEM Part #28-0822-00/90.1040.00

TRANSFORMER

- 120/240V, 50/60Hz
- Includes all parts as shown
- Fits:** Track Light, Box Assembly
- Models:** 6300 Series (before 1993)

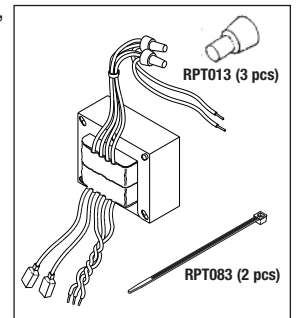

RPI Part #ADT134
OEM Part #28-0720-00/90.1040.00

TRANSFORMER

- 120/240V, 50/60Hz
- Includes all parts as shown
- Fits:** Rigid Arm Assembly on Ceiling, Wall and Unit Mounted Lights
- Models:** 6300 Series - Excellence and Preference I

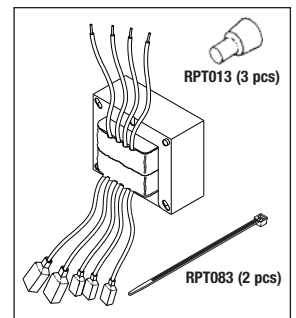

Model: A-dec Performer

RPI Part #LMP601
Industry Part #041-513-00

LAMP

- 12 V, 55 W
- PK22S base style
- Halogen
- 1/4" Quick Connect tab
- Model:** Performer

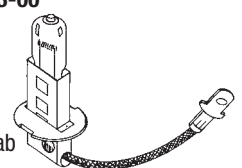

RPI Part #MAR001
 OEM Part #: Knight #152615;
 Marus #52R412; Henry Schein #1702250

REFLECTOR

Includes **FREE** Lens Splash Shield

- Reflectors are new, not re-coated
- Includes Reflector, and Lens Splash Shield (RPI Part #MAL002)

Fits: Light head **without** handles

Henry Schein Models: Crusader Style

Star-bright #'s 800-1, 800-3, 800-5 and 800-7

Knight Model: "L" Operating Light

Marus Models: Luxstar, CL1000, UL1000 and TL1000



RPI Part #MAL002
 OEM Part #: Knight #122845
 Henry Schein/Marus #52R430

LENS SPLASH SHIELD

Fits: Light head **without** handles

Henry Schein Models: Crusader Style

Star-bright #'s 800-1, 800-3, 800-5 and 800-7

Knight Model: "L" Operating Light

Marus Models: Luxstar, CL1000, UL1000 & TL1000



RPI Part #LMP608
 RITTER Part #75T3Q/CL (FDS/DZE)

LAMP

- 28 V, 75 W
- Base: Double contact, bayonet
- Halogen

Fits: Dental Light

Ritter Model: "J" Starlite



RPI Part #LMP607
 OEM Part #: Henry Schein #014R207;
 Knight #121720; Marus #014R207;
 Industry Part #75T3Q/CL

LAMP

- 24 V, 150 W
- Base: 2-pin

Fits: Dental Light

Henry Schein Models: Crusader Style

Star-bright #'s 800-1, 800-3, 800-5 and 800-7

Knight Model: "L" Operating Light

Marus Models: Luxstar, CL1000, UL1000 & TL1000



RPI Part #RCR608
 OEM Part #148774

REFLECTOR with HANDLES

Includes **FREE** Lens Splash Shield

- Reflectors are new, not re-coated
- Includes Reflector, and Lens Splash Shield (RPI Part #RCL609)

Fits: Light head **with** handles

Knight Model: "K" Super Starlite

Ritter Models: "J" Starlite & "K" Super Starlite



RPI Part #RCL609
 OEM Part #148234

LENS SPLASH SHIELD

Fits: Light head **with** handles

Knight Model: "K" Super Starlite

Ritter Models: "J" Starlite & "K" Super Starlite



RPI Part #RPC274
 OEM Part #016392

POWER CORD

- Length: 6 ft. lg.
- Color: Black
- Type: 16/3 SPT-2
- Plug NEMA 5-15P
- Flat-style cord
- Cord is rated 13 A @ 125 VAC

Models: All post mount units only



RPI Part #RCS605
 OEM Part #WO-34566

POWER SWITCH

- 8 A @ 125 VAC
- SPST
- Includes all parts as shown

Fits: Dental Light

Ritter Models: "J" Starlite & "K" Super Starlite

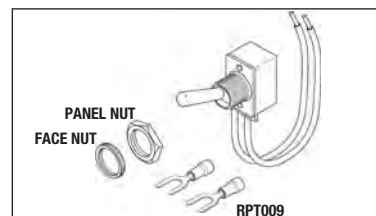

Dental Equipment

Models: Castle (Panavision & Accuvision)

RPI Part #LMP602
Industry Part #125T10/P

LAMP

- 120 V, 125 W
 - Base: Medium, prefocus
- Fits:** Dental Light
Model: Castle (Panavision)



RPI Part #RCS605
OEM Part #WO-34566

POWER SWITCH

- 8 A @ 125 VAC
 - SPST
- Includes all parts as shown**
Fits: Dental Light
Model: Castle (Accuvision)

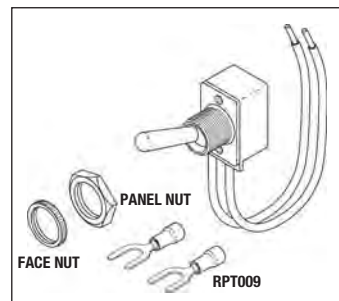

NOTES: _____

DENTAL LIGHTS - CASTLE (Panasonic & Accuvision)

SECTION 4
PAGE 1201
UPDATED 11/04

RPI Part #BES034
New OEM Part #8000-02005
Old OEM Part #800-02005

FRONT SHIELD

- Clear Lexan®
- 6.250" Dia. x 4.870" Flats x .062" THK.
- Fits:** All oval handles
- Models:** All Belmont X-Calibur with oval handles



RPI Part #BES033
OEM Part #HLU 2005

FRONT SHIELD

- Clear Lexan®
- 6.3" x 5.375" x .062" THK
- Fits:** All square handles
- Models:** All Belmont X-Calibur with square handles; All Healthco X-Calibur with square handles

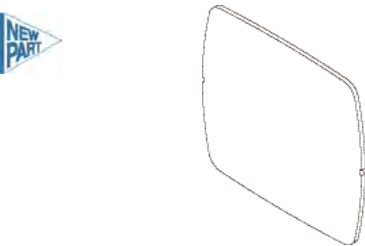

RPI Part #LMP601
Industry Part #H-3

LAMP

- 12 VDC; 55 W
- PK22s base style
- Fits:** Light socket
- Models:** All Belmont X-Calibur models; All Healthco X-Calibur models

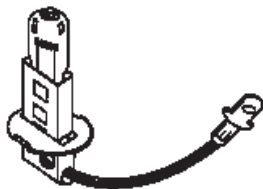

RPI Part #BEH030
OEM Part #HLU 1130

WIRE HARNESS

- Includes connectors
- 6 ft. lg.
- Fits:** Balance arm assembly
- Models:** Belmont X-Calibur 046/BLW & 047/BLC; Healthco X-Calibur 046/HLW & 047/HLC

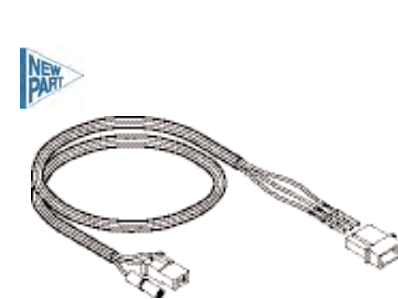

RPI Part #BEH031
OEM Part #HLU 0350

WIRE HARNESS

- Includes connectors
- 10 ft. lg.
- Fits:** Balance arm assembly
- Models:** Belmont X-Calibur HLPW; Healthco X-Calibur BLPW



RPI Part #BEH032
OEM Part #HLU 1140

WIRE HARNESS

- Includes connectors
- 8 ft. lg.
- Fits:** Track mount BLT
- Models:** Belmont X-Calibur 048/BLT; Healthco X-Calibur 048/HLT



RPI Part #BES023
OEM Part #8000-1001

POWER SWITCH

- Includes all parts as shown
- SPDT (On-Off-On); Nylon toggle
- 10 A @ 250 VAC; 15 A @ 125 VAC
- 3/4 hp, 125-250 VAC
- Fits:** Head assembly
- Models:** All Belmont X-Calibur models; All Healthco X-Calibur models

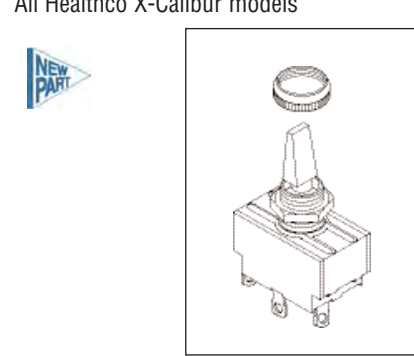

RPI Part #BES006
OEM Part #HLU 2004

SCREW (FRAME BACK COVER)

- Includes all parts as shown
- Stainless
- Special thread: #8-36 UNF
- Fits:** Back frame cover
- Models:** All Belmont X-Calibur models; All Healthco X-Calibur models

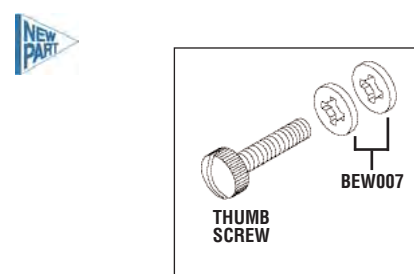

RPI Part #BET029
New OEM Part #HLU 1060

AJUSTMENT TOOL (SPRING TENSION)

- Used to adjust spring tension and head position
- Models:** All Belmont X-Calibur models; All Healthco X-Calibur models

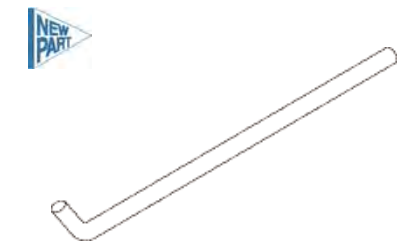

Dental Equipment

Model: Belmont X-Calibur and Healthco X-Calibur

RPI Part #BEK027

OEM Part # (No OEM Part # Available)



LIGHT SOCKET KIT

- Includes all parts as shown
- All parts also sold separately - see below

Fits: Light head assembly

Models: All Belmont X-Calibur models;
All Healthco X-Calibur models

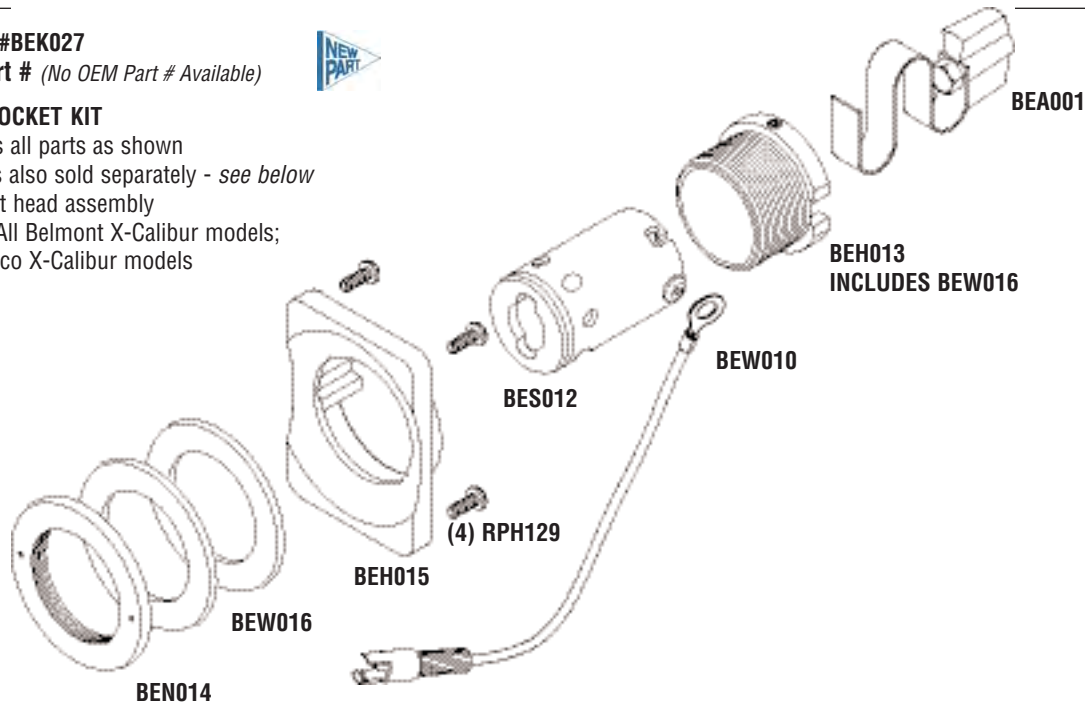

All Parts in Kit Also Sold Separately – See Below!

RPI Part #BEA001

OEM Part #8000-2023

SPRING CLIP HOLDER ASSEMBLY

Fits: Light Socket

Models: All Belmont X-Calibur models;
All Healthco X-Calibur models

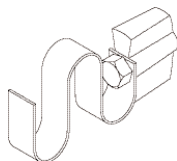

RPI Part #BES012

OEM Part #HLU 2025

LIGHT SOCKET

- Includes all parts as shown

Fits: Light Head Assembly

Models: All Belmont X-Calibur models;
All Healthco X-Calibur models

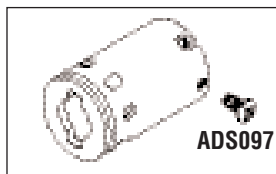

RPI Part #BEH015

OEM Part #HLU 2010

SOCKET HOUSING

- Includes all parts as shown

Fits: Light socket assembly

Models: All Belmont X-Calibur models;
All Healthco X-Calibur models

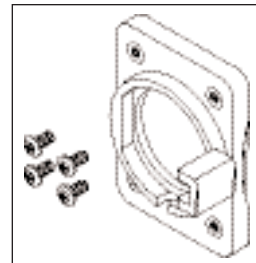

RPI Part #BEH013

OEM Part #8000-2027

SOCKET HOLDER

- Includes all parts as shown
- Brass

Fits: Light head

Models: All Belmont X-Calibur models;
All Healthco X-Calibur models

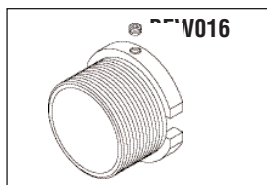

RPI Part #BEW010

New OEM Part #HLU 2026

GROUNDING WIRE ASSEMBLY

Fits: Light socket assembly

Models: All Belmont X-Calibur models;
All Healthco X-Calibur models



RPI Part #BEW016

New OEM Part #HLU 2011

RUBBER WASHER

- 2 per package
- 1.210" ID x 1.780" OD x .087" THK
- Clear silicone

Fits: Both sides of reflector assembly

Models: All Belmont X-Calibur models;
All Healthco X-Calibur models



RPI Part #BEN014

OEM Part #HLU 2012

NUT (SOCKET HOLDER)

- Anodized black

Fits: Light socket holder

Models: All Belmont X-Calibur models;
All Healthco X-Calibur models



RPI Part #BEK020
OEM Part # (No OEM Part # Available)

JOINT BOLT KIT

- When replacing **both** of the Joint Bolt Assemblies, **two** of these Kits are needed
- Includes all parts as shown

Fits: Yoke Assembly
Models: All Belmont X-Calibur models; All Healthco X-Calibur models

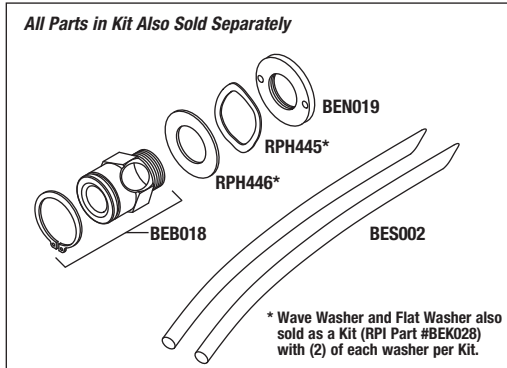

NOTES:

RPI Part #BEN019
OEM Part #HLU 2021

NUT (JOINT BOLT)

Fits: Joint Bolt Assembly
Models: All Belmont X-Calibur models; All Healthco X-Calibur models



RPI Part #BEK028
OEM Part # (No OEM Part # Available)

WASHER KIT

• Includes all parts as shown
Fits: Joint Bolt Assembly
Models: All Belmont X-Calibur models; All Healthco X-Calibur models

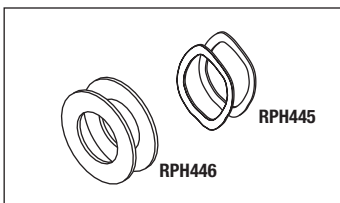

RPI Part #BEB018
OEM Part #HLU 2107

JOINT BOLT

• Includes all parts as shown
Fits: Yoke Assembly
Models: All Belmont X-Calibur models; All Healthco X-Calibur models

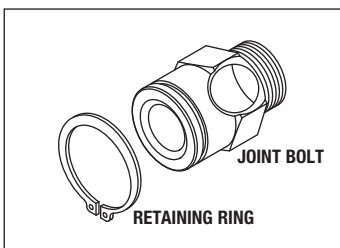

RPI Part #BES002
OEM Part #HLU 2054

RUBBER SHEEL

• 2 per package
• Material: Buna-N
• Size: ~ 5/32" dia. x ~ 4-5/8" lg.
Fits: Yoke Assembly
Models: All Belmont X-Calibur models; All Healthco X-Calibur models

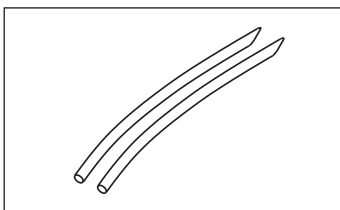

RPI Part #RPH446
OEM Part #HLU 2109

FLAT WASHER

• 2 per package
Fits: Joint Bolt Assembly
Models: All Belmont X-Calibur models; All Healthco X-Calibur models

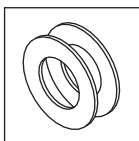

RPI Part #RPH445
OEM Part #HLU 2020

WAVE WASHER

• 2 per package
Fits: Joint Bolt Assembly
Models: All Belmont X-Calibur models; All Healthco X-Calibur models

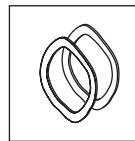

Dental Equipment

Model: Belmont Clesta 501, Clesta 502 & Clesta 505



RPI Part #BES044
OEM Part #501071

FRONT SHIELD

- Material: Clear plastic
- Fits:** Light Head
- Models:** Clesta 501, 502 & 505

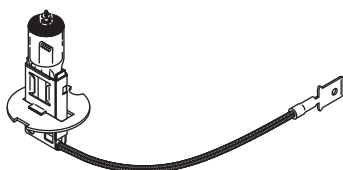
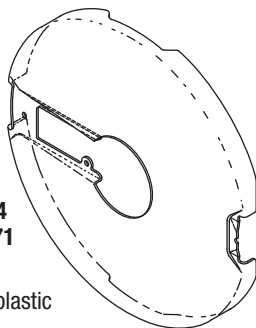

RPI Part #LMP026
OEM Part #501074

LAMP

- 24VDC, 60W
- PK22S base style with 1/4" quick connect tab
- Black tip on bulb
- Halogen
- Models:** Clesta 501, 502 & 505



RPI Part #BES046
OEM Part #501073

SPRING CLIP

- Material: Stainless steel wire
- Also Available: Lamp (Black Tip) (RPI Part #LMP026)
- Fits:** Lamp Socket Assembly
- Models:** Clesta 501, 502 & 505

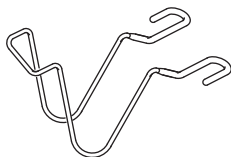

RPI Part #BES050
OEM Part #501058

PROTECTIVE RUBBER SHEET

- Material: Black rubber
- Fits:** Bracket T
- Models:** Clesta 501, 502 & 505

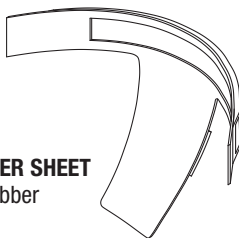

RPI Part #BEC049
OEM Part #501026

YOKE WIRE COVER

- 2 per package
- Material: Black rubber
- Fits:** Bracket T
- Models:** Clesta 501, 502 & 505

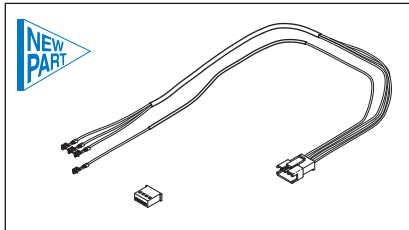
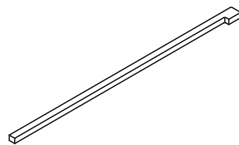

RPI Part #BEH048
OEM Part #501044 (Silicone Tubing only)/**501045** (Silicone Tubing only)/**501046** (4 Pin-Connector, Male & Harness G set only)/**501049** (4 Pin-Connector, Female only)

HARNESS (TOUCHLESS SWITCH)

- ~ 20" lg.
- Includes all parts as shown
- Fits:** Yoke Assembly
- Models:** Clesta 501, 502 & 505

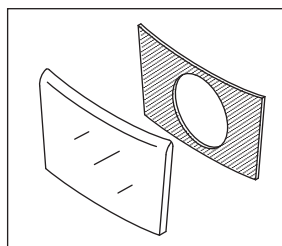

RPI Part #BEC041
OEM Part #501054 (Touchless Switch Cover Kit only)/**501055** (Touchless Switch Cover only)/**501056** (Tape only)

TOUCHLESS SWITCH COVER

- Material: Transparent smoked plastic lens
- Includes: Touchless Switch Cover and Die Cut 2-Sided Tape
- Fits:** Bracket T
- Models:** Clesta 501, 502 & 505

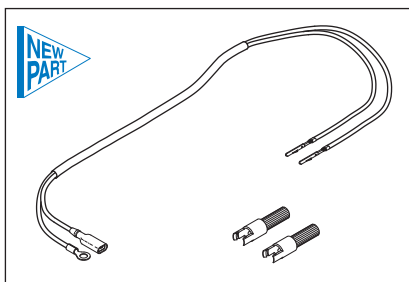

RPI Part #BEH047
OEM Part #501016 (1 Pin-Connector Female only)/**501043** (Silicone Tubing only)/**501047** (Harness I with Connector Pin & Cover only)/**501048** (Harness H with Connector Pin only)

HARNESS (LIGHT)

- ~27.50" lg.
- Includes all parts as shown
- Fits:** Yoke Assembly
- Models:** Clesta 501, 502 & 505

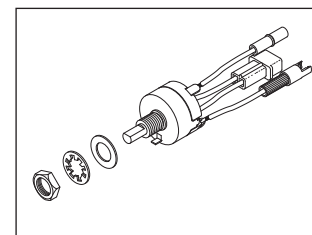

RPI Part #BES035
OEM Part #501009 (Assembly only)/**501010** (Intensity Switch only)/**501011** (2P-Connector & Harness B set only)/**501012** (2P-Connector Female)/**501013** (Harness with Connector Pin only)/**501014** (Harness with Connector Pin only)/**501015** (1P-Connector & Harness D set only)/**501016** (1P-Connector Female only)/**501017** (Harness D with Connector Pin only)/**501018** (1P-Connector & Harness C set only)/**501019** (1P-Connector Male only)/**501020** (Harness C with Connector Pin only)

INTENSITY SWITCH

- 6A @ 125VAC, 3A @ 250VAC
- 3 position (low, medium, high)
- Includes all parts as shown
- Fits:** Rear Yoke Mount Cover
- Models:** Clesta 501, 502 & 505

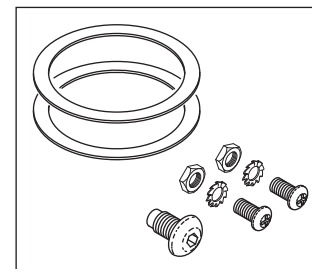

RPI Part #BEK051
OEM Part #501003 (Screw (M3x5) only)/**501004** (External Tooth Washer only)/**501005** (Nut only)/**501006** (Washer (35-29-0.25) only)/**501008** (Yoke Screw only)

YOKE PIVOT KIT

- Includes all parts as shown
- Fits:** Yoke Assembly
- Models:** Clesta 501, 502 & 505

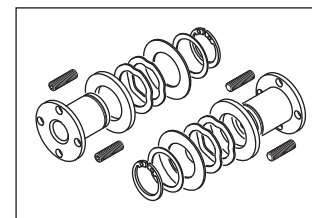

RPI Part #BEK037
OEM Part #501031 (Shaft only)/**501032** (Set Screw only)/**501033** (Washer only)/**501034** (Wave Washer only)/**501035** (Washer only)/**501041** (Retaining Ring only)/**501042** (Washer only)

YOKE DRIFT KIT

- 2 sets per package
- Material: Zinc plated steel
- Includes all parts as shown
- Fits:** Yoke Assembly
- Models:** Clesta 501, 502 & 505

SERVICE TIP

If you are replacing the original **TROLLEY BRACKET ASSEMBLY** with RPI Part #PCA657 (pictured below), you must also replace the wire harness with RPI Part #PCW620 (pictured below). The connectors on the original assembly are obsolete and were replaced by a new style connector.

RPI Part #PCA657
OEM Part #001030

TROLLEY BRACKET ASSEMBLY

Fits: Trolley to Track Power Cord connection and Wire Harness (RPI Part #PCW620)

See **SERVICE TIP** above

Models: LFT & LFT+

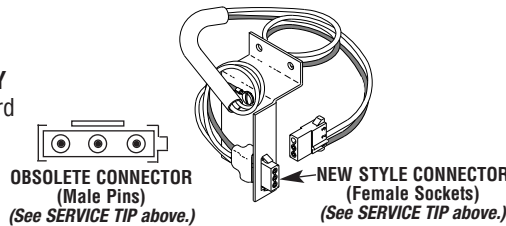

RPI Part #PCW620
OEM Part #013721

WIRE HARNESS

• Plugs into Trolley Bracket Assembly
Fits: Track Trolley Power Cord Connection

See **SERVICE TIP** above

Models: LFT & LFT+

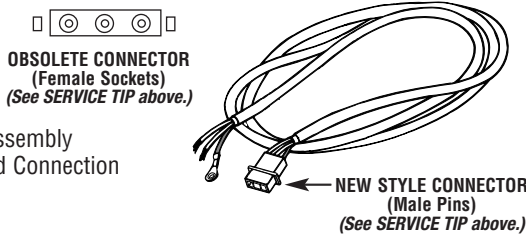

RPI Part #PCS604
New OEM Part #3321853
Old OEM Part #007096

POWER SWITCH

- SPST
- 15 A @ 125 VAC
- Toggle with 1-1/2" long bat handle and mounting hardware
- Includes all parts as shown

Fits: Switch Plate

Models: All LF & LF+

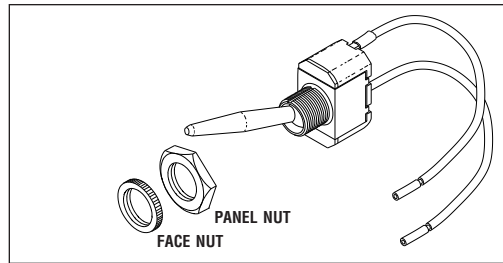

RPI Part #CAG035
OEM Part #017187

COVER GASKET

- 1/4" diameter; 36" long
- Black neoprene sponge
- Retains light socket wiring

Fits: Light Head, Yoke Groove

Models: All LF & LF+

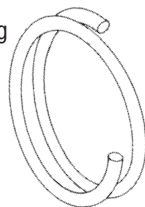

RPI Part #PCT685
OEM Part #006800

SOCKET RETRACTOR TOOL

- For installation of lamp (RPI Part #PCL606)

Models: All LF & LF+

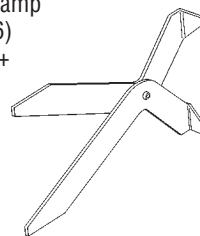

RPI Part #PCR709
New OEM Part #022438
Old OEM Part #H33-006698

REFLECTOR WITH LENS SPLASH SHIELD

- New - Not Re-coated
- Includes all parts as shown

Fits: Light Head

Models: All LF & LF+



RPI Part #PCL612
OEM Part #006777

LENS SPLASH SHIELD

- Lexan® protective shield

Fits: Lens Assembly

Models: All LF & LF+



RPI Part #PCL606
New OEM Part #3321879
Old OEM Part #017133

LAMP

- 25 V, 150 W
- Base: Double ended
- Halogen
- Requires Socket Retractor Tool (RPI Part #PCT685) for installation

Models: All LF & LF+

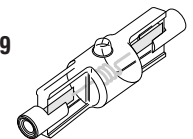

RPI Part #PCP712
OEM Part #006701

PRESSURE PAD

- 2 per package
- Fits:** Light Head

Models: All LF & LF+

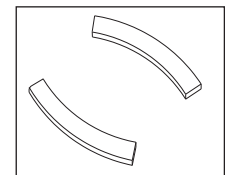

It's a GE Socket!

RPI Part #PCS605
OEM Part #007028

LIGHT SOCKET

- Made by GE
- Fits:** Socket Holder

Models: All LF & LF+

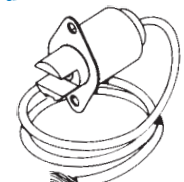

Visit RPI's Website www.rpiparts.com

Call Us Toll-Free Monday-Friday, 8:00 AM-4:30 PM (Pacific Time), (800) 221-9723

Dental Equipment

Models: LF & LF+ Series (continued)



FOR YOUR SAFETY

Use a Main Arm Spring Safety Pin (RPI Part #PCP691) to lock the Main Arm Spring Assembly in place before you service or replace the following:

- RPI Part #PCA692 Wire Harness Assembly
- RPI Part #PCC646 Knuckle & Rod Connector
- RPI Part #PCP663 Connector Hinge Pin
- RPI Part #PCK645 Arm Knuckle
- RPI Part #PCR699 Leveling Rod & Nut
- RPI Part #PCP662 Arm Hinge Pin

RPI Part #PCP691
OEM Part #022676

MAIN ARM SPRING SAFETY PIN

- See "FOR YOUR SAFETY" above.
- Stainless steel

Fits: Holes in tubular Spring Guide of Main Arm Spring Assembly

Models: All LF, LF+ & LFC+

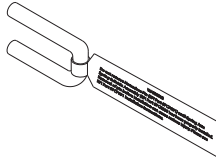

RPI Part #PCC646
OEM Part #006718

KNUCKLE & ROD CONNECTOR

- See "FOR YOUR SAFETY" above.
- Part is primed and ready to paint
- Aluminum **Not Painted**

Fits: Arm Knuckle to Leveling Rod

Models: LF, LF+ & LFC+

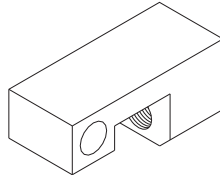

RPI Part #PCR699
OEM Part #006695 & 090412

LEVELING ROD & NUT

- See "FOR YOUR SAFETY" above.
- 5/16-24 x 17-3/8" long threaded rod with flange nut
- Stainless steel

Fits: Front Arm/Spring Guide Assembly

Models: LF, LF+ & LFC+

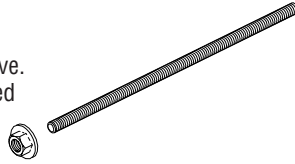

RPI Part #PCP663
OEM Part #006755

CONNECTOR HINGE PIN

- See "FOR YOUR SAFETY" above.
- 5/16" dia. x 1-5/16" long
- Stainless steel

Fits: Front Arm Assembly

Models: LF, LF+ & LFC+

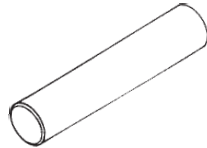

RPI Part #PCK690
OEM Part #N/A

SPRING ARM SPRING & GUIDE KIT

- See "FOR YOUR SAFETY" above.
- Includes Spring, Leveling Rod and Nut (RPI Part #PCR699), Main Arm Spring Safety Pin (PCP691), (2) Knuckle & Rod Connector (RPI Part #PCC646), and (2) Connector Hinge Pin (RPI Part #PCP663)

Fits: Front Arm Assembly

Models: LF, LF+ & LFC+

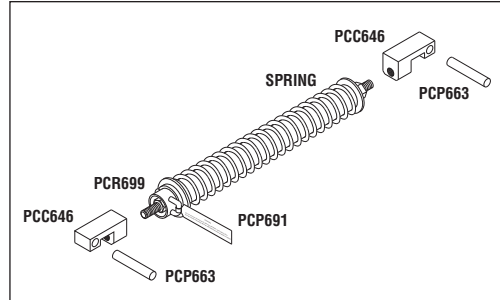

RPI Part #PCA692
OEM Part #007327

WIRE RETAINER ASSEMBLY

- See "FOR YOUR SAFETY" above.
- Includes (2) brass wire retainer, (2) 5' long #18 AWG wire, and (2) 8" long clear tubing

Fits: Main Arm Spring Assembly

Models: All LF, LF+ & LFC+

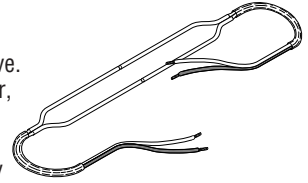

RPI Part #PCP662
OEM Part #006756

See "FOR YOUR SAFETY" above.

ARM HINGE PIN

- Includes: (2) RPI Part #RPH255 and (2) RPI Part #RPH107
- 5/16" dia. x 1-5/8" long
- Stainless steel

Fits: Front Arm Assembly

Models: LF, LF+ & LFC+

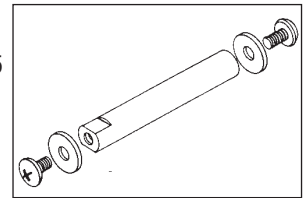

READ THIS BEFORE ORDERING DRIFT KIT (RPI PART #PCK651) TO SERVICE THE LF, LF+ or LFC+

The RPI Drift Kit (RPI Part #PCK651) can **only** be used with the redesigned RPI Arm Knuckle (RPI Part #PCK645).

RPI Part #PCK645
OEM Part #007037

ARM KNUCKLE

- See Drift Kit (RPI Part #PCK651)
- Part is primed and ready to paint
- Aluminum **Not Painted**
- Use in front or rear position

Fits: Front Arm Assembly

Models: LF, LF+ & LFC+

REDESIGNED TO ELIMINATE DRIFT
when used with RPI Drift Kit (RPI Part #PCK651)

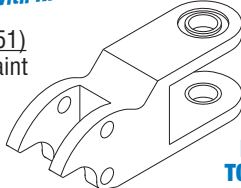

READY TO PAINT!

RPI Part #PCK651
OEM Part #N/A

DRIFT KIT

- For use **only** with the redesigned RPI Arm Knuckle (RPI Part #PCK645)
- Includes snubbing pin, wave washer and flat washer
- Use to eliminate drift in light

Fits: Arm Knuckle to Leveling Rod

Models: LF, LF+ & LFC+

ELIMINATE DRIFT!
For use **ONLY** with the RPI redesigned Arm Knuckle (RPI Part #PCK645)

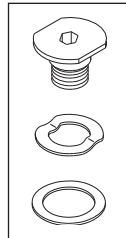

**RPI Part #PCA644
OEM Part #007038**

ARM ADAPTER

- Part is primed and ready to paint
 - Aluminum (**Not Painted**)
 - Includes arm adapter, and (2) set screw (RPI Part #RPH201)
- Fits:** Rear Arm to Arm Knuckle
Models: LF & LF+

READY TO PAINT!

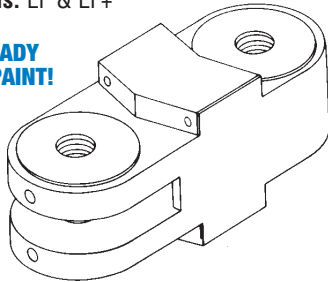

**NEW RPI Part #RPH201
OLD RPI Part #PCS666
OEM Part #090251**

SOCKET HEAD SET SCREW

- 50 per package
 - #8-32 x 1/4" lg.
 - Black alloy
 - Also in Socket Head Set Screw Kit (RPI Part #RPK418)
- Fits:** Adaptor Arm (RPI Part #PCA644)
Models: LF & LF+



**RPI Part #PCB616
Old OEM Part #H32-104**

BUSHING YOKE

- 2 per package
 - Stainless steel
- Fits:** Head and yoke assembly
Model: All LF & LFT+

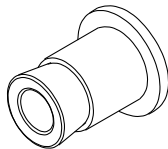

**RPI Part #RPH192
OEM Part # (None)**

SOCKET HEAD SCREW

- 50 per package
 - #6-32 x 3/8" lg.
 - Stainless steel
- Fits:** Yoke to bushing
Model: All LF & LFT+



**RPI Part #PCB617
OEM Part #006914**

STUD - HEAD BUSHING

- 2 per package
 - Stainless steel
- Fits:** Head and yoke assembly
Model: All LF & LFT+

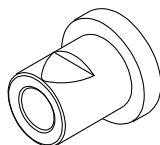

**RPI Part #PCS659
OEM Part #006704**

COUNTER BALANCE SPRING

- 2 per package
 - 2.575" lg. x .360" OD
 - Stainless steel
- Fits:** Front Arm Assembly
Models: LF & LF+

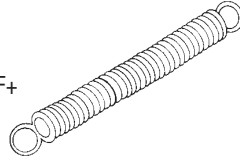

**RPI Part #PCC664
OEM Part #006767**

COUNTER BALANCE SPRING COVER

- 2 per package
 - Steel, zinc plated (**Not Painted**)
 - Used to cover Counter Balance Spring
- Models:** LF & LF+

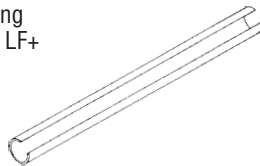

**RPI Part #PCI661
OEM Part #006687**

COUNTER BALANCE SPRING COVER INSERT

- 4 per package
 - Gray rubber
- Fits:** Counter Balance Spring Cover
Models: LF & LF+

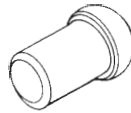

**RPI Part #PCR673
OEM Part #006747**

COUNTER BALANCE SPRING RETAINER

- Stainless steel
 - Includes counter balance spring retainer, and (2) #8-32 x 1/4" lg. Phillips head screw
 - Use Socket Head Screw (RPI Part #RPH198) to mount retainer
- Fits:** Rear Arm Knuckle
Models: All LF & LF+

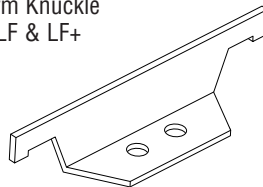

**RPI Part #RPH234
OEM Part #3325284**

BALANCE RETAINER SCREW

- 12 per package
 - #8-32 x 1/4 lg. Round Head Phillips
 - 18-8 Stainless steel
- Fits:** Counter Balance Spring Retainer (RPI Part #PCR673)
Models: All LF & LF+



**RPI Part #PCK660
OEM Part #006769**

SPRING RETAINER WITH WASHER

- 2 per package
 - Stainless steel
- Fits:** Counter Balance Spring/Front Arm
Models: LF & LF+

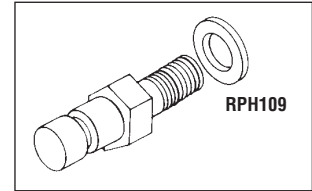

**RPI Part #RPH233
OEM Part #3324151**

FRONT ARM COVER SCREW

- 12 per package
 - #10-32 x 3/8" lg. Round Head Phillips
 - 18-8 Stainless steel
- Fits:** Front Arm Cover
Models: All LF & LF+ Series

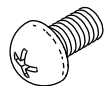

**RPI Part #PCS689
OEM Part #006700**

FOCUS SPRING

- 2 per package
- Fits:** Focus Bracket on Head Assembly
Models: LF & LF+

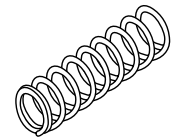

**RPI Part #PCS658
OEM Part #007031**

KNUCKLE HINGE SCREW

- 2 per package
 - 7/16-20
 - 3/16 hex socket
 - Stainless steel
- Fits:** Arm Knuckle
Models: LF, LF+ & LFC

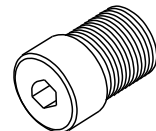

**RPI Part #PCW665
OEM Part #006702**

KNUCKLE WASHER

- 12 per package
 - Nylon® (white)
 - 9/16 ID x 1" OD x .020 thk
- Fits:** Arm Knuckle & Arm Adapter
Models: LF, LF+ & LFC



**RPI Part #PCS675
OEM Part #3322968**

SPACER

- 12 per package
 - Nylon® (white)
 - .257" ID x .500" OD x .031" thk
- Fits:** Front Arm Assembly
Models: All LF & LF+



Dental Equipment

Models: LF & LF+ Series *(continued)*

RPI Part #PCS681
New OEM Part #3321820
Old OEM Part #013553

DIMMER SWITCH

- 3 position
- 15 AMP, 125 VAC, 1/2 H.P.
- 1/2" hole mount
- On some lights, it may be necessary to increase the size of the mounting hole to accommodate this switch

Fits: Rear Arm

Models: LF, LF+ & LFC

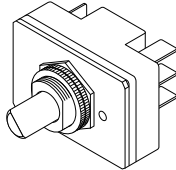

RPI Part #BUK042
New OEM Part #3322646
Old OEM Part #015408

DIMMER KNOB

Fits: Dimmer Switch

Models: LF, LF+ & LFC



RPI Part #PCT621
New OEM Part #3321846
Old OEM Part #015768

TRANSFORMER

- Primary=120V, 60 Hz. tap;
- Secondary=Com. 19V, 21V, 23V, 25V, 6A

Fits: Rear Arm

Models: LF, LF+ & LFC+

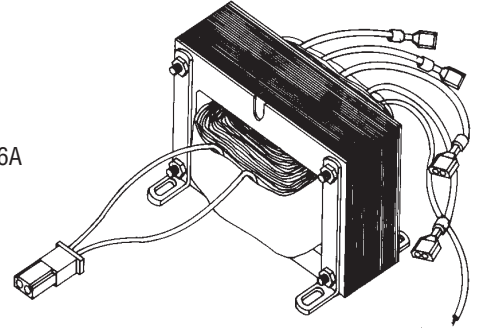

RPI Part #RPC274
OEM Part #016392

POWER CORD

- 13 A @ 125 VAC
- Length: 6 feet
- Color: Black
- Type: 16/3 SPT-2
- Plug NEMA 5-15P
- Flat-style cord

Models: LF & LF+ post mounted units only

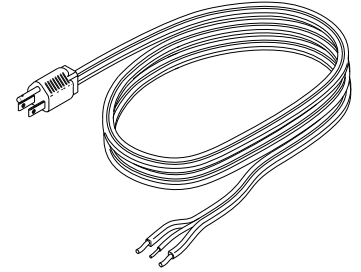

RPI Part #PCT622
OEM Part #015892

TRANSFORMER

- Primary=120V, 60 Hz. tap.;
- Secondary=0V, 25V, 27V, 6A

Fits: Rear Arm

Models: LFT+ & LFIT-D

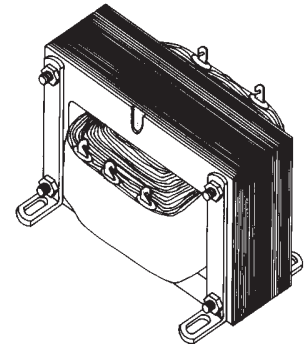

NOTES: _____

RPI Part #PCL606
OEM Part #3321879 & 017133

LAMP

- 25VAC, 150W; Halogen
- Base: Double ended
- Also available: Light Socket (RPI Part #PCS607)

Models: All LFII, LFIII, LFIIIS & LFIIISE

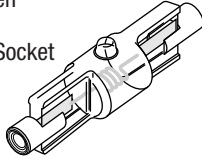

RPI Part #PCS607
OEM Part #3336992 & 015208

LIGHT SOCKET

- Also available: Lamp (RPI Part #PCL606)

Fits: Socket Holder

Models: All LFII, LFIII, LFIIIS & LFIIISE

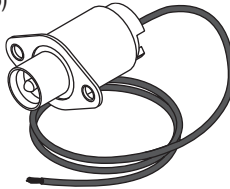

RPI Part #CAG035
OEM Part #017187

COVER GASKET

- Black neoprene sponge
- 1/4" dia. x 36" lg.
- Retains light socket wiring

Fits: Light Head, Yoke Groove

Models: All LFII, LFIII, LFIIIS & LFIIISE



RPI Part #PCB623
OEM Part #014901 (1 per pkg.) & 023940 (2 per pkg.)

REFLECTOR PIVOT BUSHING KIT

- 2 per package
- Plastic

Fits: Yoke to Yoke Cover

Models: All LFII, LFIII, LFIIIS & LFIIISE

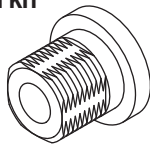

RPI Part #RPH203
OEM Part #090959

SOCKET HEAD SET SCREW

- 50 per package
- Material: Black oxide steel
- Size: #8-32 x 3/8" lg.
- Also available: Socket Head Set Screw Kit (RPI Part #RPK418)

Fits: Head Assembly

Models: All LFII

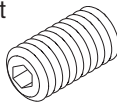

RPI Part #RPH197
OEM Part #090245

SOCKET HEAD SET SCREW

- 50 per package
- Material: Black oxide steel
- Size: #6-32 x 5/16" lg.
- Also available: Socket Head Set Screw Kit (RPI Part #RPK418)

Fits: Head Assembly

Models: All LFII

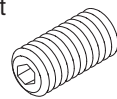

RPI Part #PCA805
OEM Part #33 21 838



HANDLE ASSEMBLY

- Material: Off White ABS
- Snaps onto Light Head and is easily removable

Fits: Light Head Assembly

Models: All models of LFII & LFIII

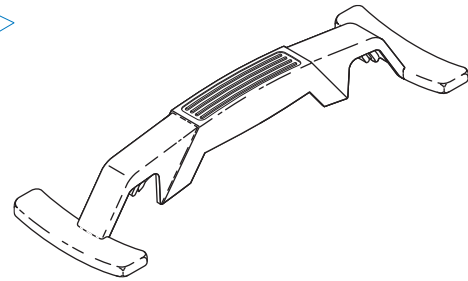

RPI Part #PCR710
OEM Part #3321887 & HB3-014062

REFLECTOR WITH LENS SPLASH SHIELD

- **NEW - Not Re-coated**
- Includes all parts as shown

Fits: Light Head

Models: All LFII

FREE
LENS SPLASH SHIELD & CUSHION KIT
WITH PURCHASE OF REFLECTOR!

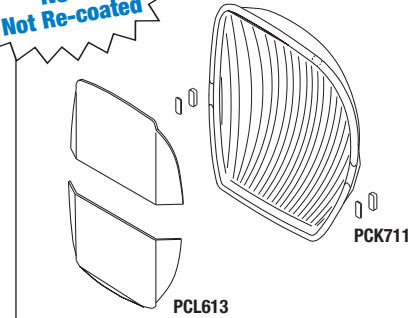

RPI Part #PCL613
OEM Part #3321598 & 015310

LENS SPLASH SHIELD

- Includes: upper shield, and lower shield
- Lexan® protective shield
- Also included in: Reflector With Splash Shield (RPI Part #PCR710)

Fits: Lens Assembly

Models: All LFII, LFIII, LFIIIS & LFIIISE

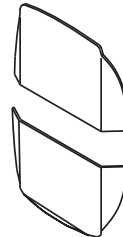

RPI Part #PCK711
OEM Part #015458 (Pad Only) & 015899 (Cushion Only)

CUSHION KIT

- Includes: (2 pcs) Pressure Pad and (2 pcs) Reflector Cushion
- Also included in: Reflector With Splash Shield (RPI Part #PCR710)

Fits: Light Head

Models: All LFII, LFIII & LFIIISE

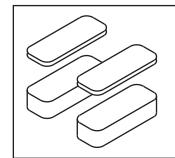

RPI Part #PCA683
OEM Part #014707

RELEASE PIN ASSEMBLY

- Material: Nickel plated brass
- Includes all parts as shown

Fits: Head Assembly

Models: All LFII, LFIII, LFIIIS & LFIIISE

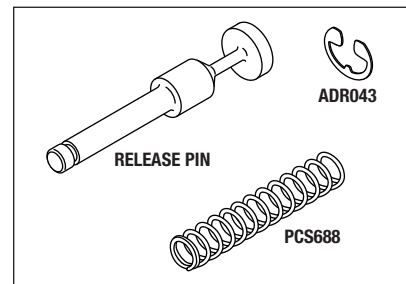

RPI Part #PCP684
OEM Part #026471

HINGE PIN

- Material: Stainless steel
- Includes all parts as shown
- This Hinge Pin *replaces* the OEM's Spacers and Screws

Fits: Head Assembly

Models: All LFII, LFIII, LFIIIS & LFIIISE

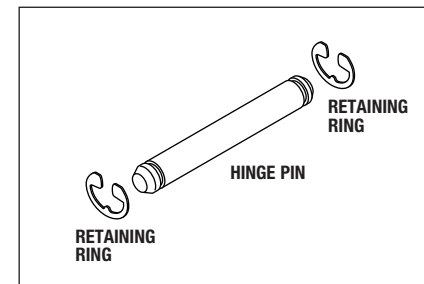

Dental Equipment

Model: LFI & LFIII Series (continued)

RPI Part #PCS604
OEM Part #3321853 & 007096

POWER SWITCH

- 15A@125VAC: SPST
- Toggle with 1-1/2" lg. bat handle and mounting hardware
- Includes all parts as shown
- Also included in: Sensor Conversion Kit (RPI Part #PCK803)

Fits: Switch Plate
Models: All LFI

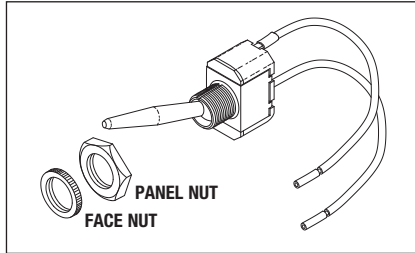

RPI Part #PCS804
OEM Part #014R379

SWITCH (INTENSITY)

- 6A @ 125VAC; SPDT; On/Off/On
- Includes all parts as shown

Fits: Yoke Assembly

Models: LFIII, LFIIC, LFIICB, LFIIC-D, LFIIS, LFIISE, LFIIT, LFIIT-D & LFIIW

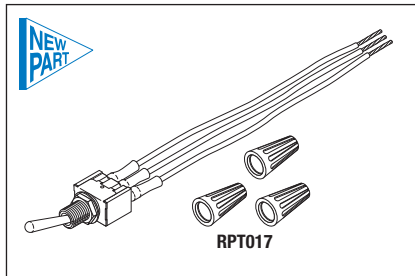

RPI Part #PCK803
OEM Part #051077 (Silver) & 054866LG (Grey)

SENSOR CONVERSION KIT

- Converts LFIII Touchless Sensor (OEM Part #052157) to manually operated On/Off
- 15A @ 125VAC; SPST
- Toggle with 1-1/2" lg Bat Handle
- Includes all parts as shown

Fits: Yoke assembly

Models: LFIII, LFIIC, LFIICB, LFIIC-D, LFIIL, LFIIT, LFIIT-D, LFIIW & LFIIW-D

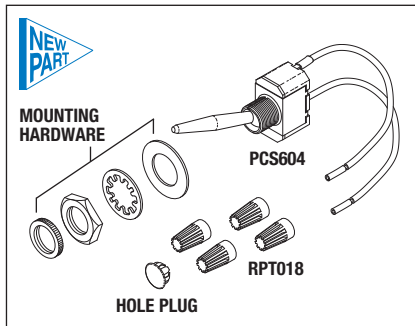

RPI Part #PCA680
OEM Part #001072



DIMMER SWITCH ASSEMBLY

- Includes: Knob (RPI Part #BUK042)
- Fits:** Post Knuckle Assembly
Models: LFIIT, LFIIT-D, LFIIT & LFIIT-D

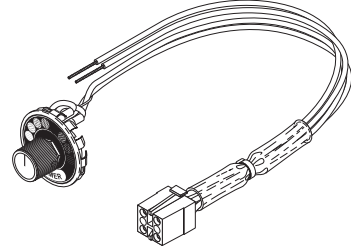

RPI Part #PCS681
OEM Part #3321820 & 013553

DIMMER SWITCH

- 3 position
- 15AMP @ 125VAC
- 1/2" bushing mount
- 1/4" tabs
- Includes: mounting hardware

Fits: Rear Arm

Models: LFI, LFIIC, LFIIC-D, LFIII, LFIIC, LFIIC-D & LFIICB

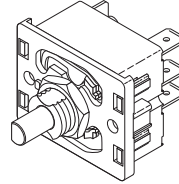

RPI Part #BUK042
OEM Part #33 22 646 & 015408

DIMMER/SENSITIVITY KNOB

- Shaft size: 1/4" dia.
- Also included in: Dimmer Switch Assembly (RPI Part #PCA680)

Fits: Dimmer Switch

Models: LFI, LFIIC, LFIIC-D, LFIIL, LFIIT, LFIIT-D, LFIIW, LFIIW (2), LFIIW (3), LFIIS, LFIIC, LFIICB, LFIIC-D, LFIIS, LFIISE, LFIIT, LFIIT-D & LFIIW

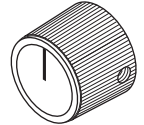

SERVICE TIP - If this is your first time servicing or replacing any or all of the following parts, it is recommended that you order or download from our website (www.rpiparts.com) a **FREE** copy of the "INSTRUCTIONS FOR THE REPLACEMENT OF GAS OR MECHANICAL SPRING" (RPI Part #PCA700INS) and the "RPI Exploded View of the LFI Lights" (RPI Part #EXP001). These handy work tools will assist you with your servicing or repairing of the equipment.

RPI Part #PCA698
OEM Part #001068



DIMMER CIRCUIT ASSEMBLY

- Includes: Insulator sheet
- Fits:** Column Assembly of Standard Trolley Assembly (OEM Part #001032) & Standard Dual Trolley Assembly (OEM Part #001319)
Models: LFIIT & LFIIT-D

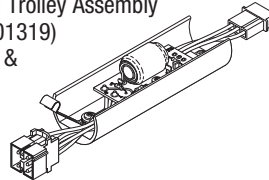

RPI Part #PCA794
OEM Part #045782



DIMMER CIRCUIT ASSEMBLY

- Includes: Insulator sheet
- Fits:** Column Assembly of Standard Trolley Assembly (OEM Part #001032) & Standard Dual Trolley Assembly (OEM Part #001319)
Models: LFIIT & LFIIT-D

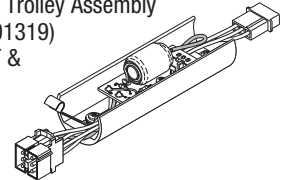

SERVICE TIP - Wire Harness Extensions (RPI Part #'s PCH798 and PCH799) can be connected to each other to accommodate various operatory ceiling heights.

RPI Part #PCH798
OEM Part #001295



WIRE HARNESS EXTENSION

- ~11" lg.
 - Also available: 23" long version Wire Harness Extension (RPI Part #PCH799)
- Fits:** Standard Trolley Assembly (OEM Part #001032), Standard Dual Trolley Assembly (OEM Part #001319)
Models: LFIIT, LFIIT-D, LFIIT, LFIIT-D

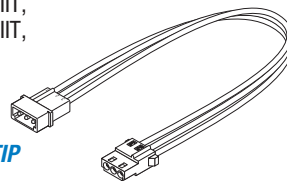

See **SERVICE TIP** above

RPI Part #PCH799
OEM Part #001298



WIRE HARNESS EXTENSION

- ~23" lg.
 - Also available: 11" long version Wire Harness Extension (RPI Part #PCH798)
- Fits:** Standard Trolley Assembly (OEM Part #001032), Standard Dual Trolley Assembly (OEM Part #001319)
Models: LFIIT, LFIIT-D, LFIIT, LFIIT-D

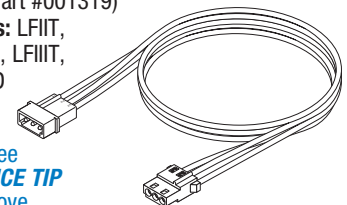

See **SERVICE TIP** above

SERVICE TIP

If this is your first time servicing or replacing any or all of the following parts, it is recommended that you order or download from our website (www.rpiparts.com) a **FREE** copy of the "INSTRUCTIONS FOR THE REPLACEMENT OF GAS OR MECHANICAL SPRING" (RPI Part #PCA700INS) and the "RPI Exploded View of the LFIIL Lights" (RPI Part #EXP001). These handy work tools will assist you with your servicing or repairing of the equipment.

RPI Part #PCK800
OEM Part #33 24 501

POST KNUCKLE ASSEMBLY

- Material: Aluminum **Not Painted**
- Part is primed and ready for paint
- Includes: Installed bushings
- Also available: Post Knuckle Hardware Kit (RPI Part #PCK807)

Fits: Rear Arm Adapter
Models: LFIIT, LFIIT-D, LFIIT & LFIIT-D

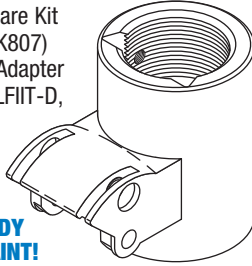

RPI Part #PCK807
OEM Part #33 24 105 (Wave Washer Only),
090959 (Set Screw Only), 33 24 154 (Screw Only)
& 30 05 001 (Spring Pin Only)

POST KNUCKLE HARDWARE KIT

- Includes all parts as shown
- Also available: Post Knuckle Assembly (RPI Part #PCK800)

Fits: Post Knuckle Assembly

Models: LFIIC, LFIIC-D, LFIIT, LFIIT-D, LFIIC, LFIIC-D, LFIIT & LFIIT-D

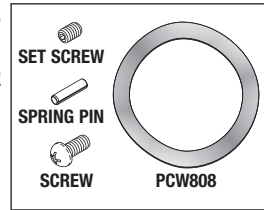

RPI Part #PCW808
OEM Part #33 24 105

WAVE WASHER

- 5 per package
- Material: Spring steel
- Size: 1.400" ID x 1.777" OD x .013" thk
- Also included in: Post Knuckle Hardware Kit (RPI Part #PCK807)
- Also available: Post Knuckle Assembly (RPI Part #PCK800)

Fits: Post Knuckle Assembly
Models: LFIIC, LFIIC-D, LFIIT, LFIIT-D, LFIIC, LFIIC-D, LFIIT & LFIIT-D

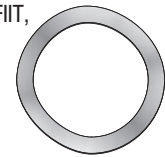

SERVICE TIP

If you are replacing the original **TROLLEY BRACKET ASSEMBLY** with RPI Part #PCA657 (pictured below), you must also replace the wire harness with RPI Part #PCW620 (pictured below). The connectors on the original assembly are obsolete and were replaced by a new style connector.

RPI Part #PCA657
OEM Part #001030

TROLLEY BRACKET ASSEMBLY

Fits: Trolley to Track Power Cord connection and Wire Harness (RPI Part #PCW620)

See **SERVICE TIP** above

Models: LFIIT, LFIIT-D, LFIIT & LFIIT-D

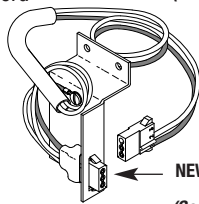

OBSOLETE CONNECTOR (Male Pins)
(See **SERVICE TIP** above.)

NEW STYLE CONNECTOR (Female Sockets)
(See **SERVICE TIP** above.)

RPI Part #PCW620
OEM Part #013721

WIRE HARNESS

- Plugs into Trolley Bracket Assembly

Fits: Track Trolley Power Cord Connection
See **SERVICE TIP** above

Models: LFIIT, LFIIT-D, LFIIL & LFIIL-D

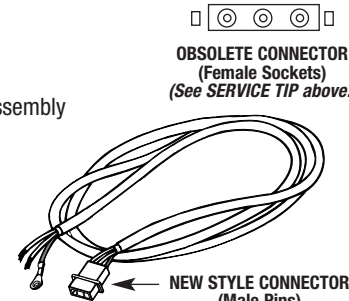

OBSOLETE CONNECTOR (Female Sockets)
(See **SERVICE TIP** above.)

NEW STYLE CONNECTOR (Male Pins)
(See **SERVICE TIP** above.)

RPI Part #PCA795
OEM Part #33 24 329

GUIDE PLATE ASSEMBLY

- Material: Zinc plated steel
- Each Trolley Assembly requires (2) Guide Plate Assemblies (RPI Part #PCA795)
- Includes: (2 pcs each) Dowel Pin (RPI Part #RPP750) and Roller (RPI Part #PCR796)

Fits: Standard Trolley Assembly (OEM Part #001032) & Standard Dual Trolley Assembly (OEM Part #001319)

Models: LFIIT, LFIIT-D, LFIIT & LFIIT-D

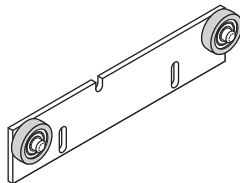

RPI Part #RPP750
OEM Part #001384

DOWEL PIN

- 2 per package
- Material: Alloy steel hardened
- Size: .250" dia. x .625" lg.
- Also included in: Guide Plate Assembly (RPI Part #PCA795)

Fits: Guide Plate Assembly, Standard Trolley Assembly (OEM Part #001032) & Standard Dual Trolley Assembly (OEM Part #001319)

Models: LFIIT, LFIIT-D, LFIIT & LFIIT-D

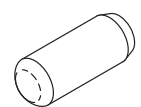

RPI Part #PCR796
OEM Part #33 24 451

ROLLER

- Material: Plastic outer sleeve over stainless steel ball bearing
- Size: .250" ID x .896" OD x .250" thk
- Also included in: Guide Plate Assembly (RPI Part #PCA795)

Fits: Guide Plate Assembly, Standard Trolley Assembly (OEM Part #001032) & Standard Dual Trolley Assembly (OEM Part #001319)

Models: LFIIT, LFIIT-D, LFIIT & LFIIT-D

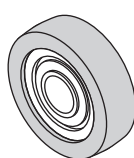

RPI Part #PCP797
OEM Part #33 24 345

SPIRAL PIN

- 10 per package
- Material: Zinc plated steel
- Size: .250" dia. x 1.00" lg.
- Also available: Roller (RPI Part #PCR796)

Fits: Standard Trolley Assembly (OEM Part #001032) & Standard Dual Trolley Assembly (OEM Part #001319)

Models: LFIIT, LFIIT-D, LFIIT & LFIIT-D

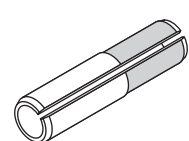

Dental Equipment

Models: LFII & LFIII Series (continued)

SERVICE TIP

If this is your first time servicing or replacing any or all of the following parts, it is recommended that you order or download from our website (www.rpiparts.com) a **FREE** copy of the "INSTRUCTIONS FOR THE REPLACEMENT OF GAS OR MECHANICAL SPRING" (RPI Part #PCA700INS) and the "RPI Exploded View of the LFII Lights" (RPI Part #EXP001). These handy work tools will assist you with your servicing or repairing of the equipment.

RPI Part #PCB667
OEM Part # (No OEM Part # Available)

TIE BARS

- 2 per package
- **Also included in: RPI Part #'s PCS647, PCS648, PCS649 & PCS650**
- Not used with RPI Part #'s PCS601 & PCS602

Fits: Front Arm Assembly
Models: All LFII, LFIII, LFIIIC, LFIIT, LFIIT-D, LFIIC-D & LFIICB

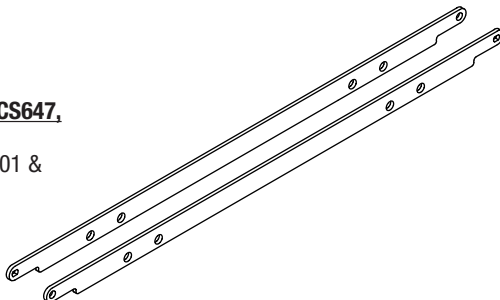

RPI Part #PCW603
OEM Part #015769

WIRE HARNESS ASSEMBLY

- 6 ft. lg.
 - Female sockets
- Fits:** Transformer to Adaptor
Models: All LFII, LFIII & LFIIC



RPI Part #PCK668
OEM Part #015810

DROP KNUCKLE

- Material: Aluminum **Not Painted**
 - Part is primed and ready to paint
 - Includes: installed bushings
 - Includes all parts as shown
- Fits:** Drop Arm to Front Arm
Models: LFIIC, LFIIC-D, LFIIT, LFIIT-D, LFIIW(2), LFII, LFIIW, LFIIT-D, LFIIC & LFIIC-D

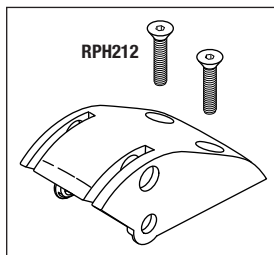

READY TO PAINT!

RPI Part #RPH212
OEM Part #33 24 170 & 090713

FLAT HEAD HEX SOCKET CAP SCREW

- 12 per package
 - Material: Black alloy steel
 - Size: #10-24 x 3/4" lg.
- Fits:** Drop Knuckle to Drop Down Arm
Models: LFIIC, LFIIC-D, LFIIT, LFIIT-D, LFIIW(2), LFIIC, LFIICB, LFIIC-D, LFIIT & LFIIT-D

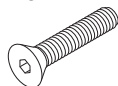

RPI Part #PCK669
New OEM Part #3325169
Old OEM Part #015809

STRAIGHT KNUCKLE

- Material: Aluminum **Not Painted**
 - Part is primed and ready to paint
 - Includes: installed bushings
 - Use in front or rear position
 - Also available: Drift Kit (RPI Part #PCK651)
- Fits:** Front Arm Assembly
Models: LFII, LFIIW(3), LFII, LFIIC, LFIIC-D, LFII, LFIIC & LFIIC-D

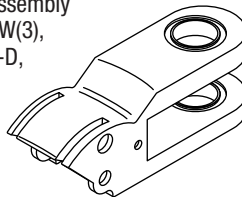

READY TO PAINT!

RPI Part #PCP678
OEM Part #3322976 & 025433

KNUCKLE PIVOT PIN

- 2 per package
 - Stainless steel
- Fits:** Front Arm Assembly
Models: All LFII, LFIII, LFIIC, LFIIT, LFIIT-D, LFIIC-D & LFIICB

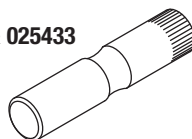

RPI Part #PCP677
OEM Part #3322604 & 015433

TIE BAR PIVOT PIN

- 2 per package
 - Stainless steel
- Fits:** Front Arm Assembly
Models: All LFII, LFIII, LFIIC, LFIIT, LFIIT-D, LFIIC-D & LFIICB

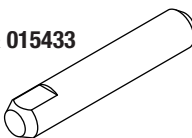

RPI Part #PCS675
OEM Part #3322968

SPACER

- 12 per package
 - Material: Nylon® (white)
 - Size: .257" ID x .500" OD x .031" THK
- Fits:** Front Arm Assembly
Models: All LFII & LFIII



RPI Part #PCS671
OEM Part #4191222

FRONT KNUCKLE SUPPORT

- Material: Aluminum
 - Includes: installed bushings
 - Includes all parts as shown
- Fits:** Front Arm Assembly
Models: All LFII, LFIII, LFIIC, LFIIT, LFIIT-D, LFIIC-D & LFIICB

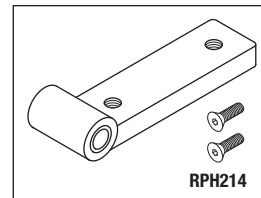

RPI Part #PCS672
OEM Part #015806

REAR KNUCKLE SUPPORT

- Material: Aluminum
 - Includes: installed bushings
 - Includes all parts as shown
 - Use the 5/8" socket head set screw (RPI Part #RPH211) for gas spring adjustment
- Fits:** Front Arm Assembly
Models: All LFII, LFIII, LFIIC, LFIIT, LFIIT-D, LFIIC-D & LFIICB

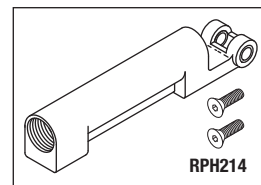

RPI Part #RPH214
OEM Part #3323115 & 090191

FLAT HEAD HEX SOCKET CAP SCREW

- 12 per package
 - Material: Black alloy steel
 - Size: #10-24 x 1/2" lg.
- Fits:** Front Support Knuckle (RPI Part #PCS671) & Rear Support Knuckle (RPI Part #PCS672)
Models: All LFII, LFIII, LFIIC, LFIIT, LFIIT-D, LFIIC-D & LFIICB



RPI Part #RPH211
OEM Part #090650

SOCKET HEAD SET SCREW

- Material: Black alloy steel
 - Size: 5/8-11 x 5/8" lg.
- Fits:** Rear Knuckle Support
Models: All LFII, LFIII, LFIIC, LFIIT, LFIIT-D, LFIIC-D & LFIICB



RPI Part #PCT621
OEM Part #3321846 & 015768

TRANSFORMER

- Primary=117V, 60 Hz.
- Secondary=Com. 19V, 21V, 23V, 25V @ 6A

Fits: Rear Arm

Models: LFII, LFIIIC, LFIIIC-D, LFIIIL, LFII(2), LFIIW(3) & LFIIC

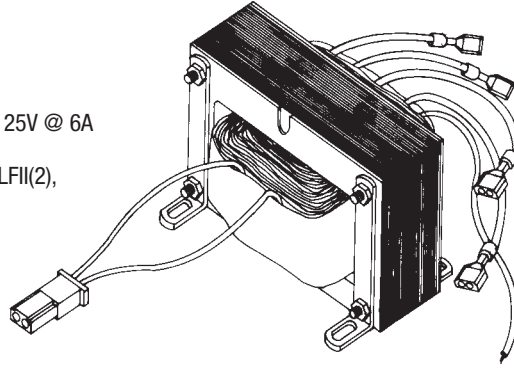

RPI Part #RPC274
OEM Part #016392

INDUSTRIAL GRADE POWER CORD

- Color: Black
 - Length: 6 ft.
 - 16/3 SPT-2, 105°C; 13A @ 125 VAC
 - Plug Type: NEMA 5-15P
 - Connector Type: None; 0.158" x 0.380" Flat cord
- Models:** LFII & LFIII post mounted lights only

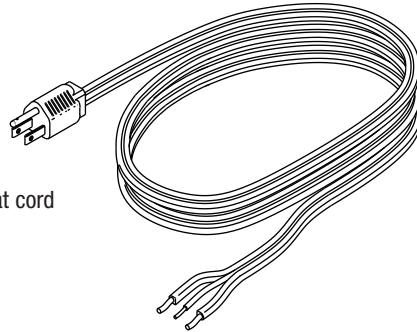

RPI Part #PCT622
OEM Part #015892

TRANSFORMER

- Primary=117V, 60 Hz.
- Secondary=0V, 25V, 27V @ 6A

Fits: Rear Arm

Models: LFIIT, LFIIT, LFIIT-D, LFIIT-D & LFIICB

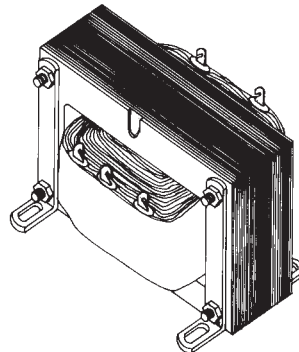

RPI Part #PCC801
OEM Part #33 35 275

BEARING CAP

- Material: Aluminum **Not Painted**
- Part is primed and ready to paint
- Also available: Flat Head Hex Socket Cap Screw (RPI Part #RPH212)

Fits: Drop Down Arm

Models: LFIIC, LFIIC-D, LFIIT, LFIIT-D, LFIIW, LFIIC, LFIIC-D, LFIIT, LFIIT-D & LFIIW

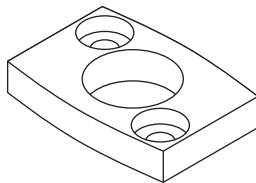

READY TO PAINT!

RPI Part #RPH212
OEM Part #33 24 170 & 090713

FLAT HEAD HEX SOCKET CAP SCREW

- 12 per package
- Material: Black alloy steel
- Size: #10-24 x 3/4" lg.

Fits: Drop Knuckle to Drop Down Arm

Models: LFIIC, LFIIC-D, LFIIT, LFIIT-D, LFIIW(2), LFIIC, LFIICB, LFIIC-D, LFIIT & LFIIT-D

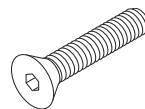

RPI Part #PCR694
OEM Part #015186

PIVOT ROD

- Material: Zinc plated steel
- Fits:** Down/Drop Arm and Yoke Assembly

Models: LFIIC, LFIIC-D, LFIIT, LFIIT-D, LFIIW(2), LFIIC, LFIICB, LFIIT & LFIIT-D

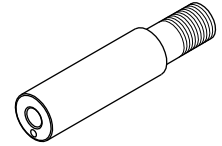

RPI Part #RPP093
OEM Part #007466

SPRING (ROLL) PIN

- 12 per package
- Material: Zinc plated steel
- Size: 1/8" dia. x 3/4" lg.

Fits: Drop Arm & Pivot Rod

Models: LFIIC, LFIIC-D, LFIIT, LFIIT-D, LFIIW(2), LFIIC, LFIICB, LFIIT & LFIIT-D

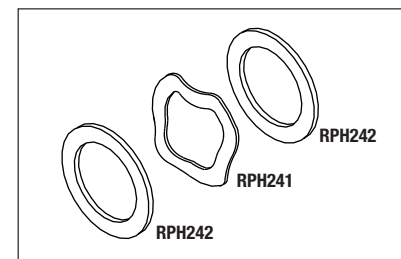
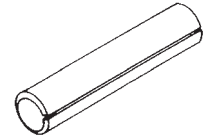

RPI Part #PCK693
OEM Part # (No OEM Part # Available)

WAVE WASHER KIT

- Includes all parts as shown
- Fits:** Pivot Rod to Yoke Assembly
- Models:** LFIIC, LFIIC-D, LFIIT, LFIIT-D, LFIIW(2), LFIIC, LFIICB, LFIIT & LFIIT-D

RPI Part #RPH241
OEM Part #015502

WAVE WASHER

- 5 per package
- Size: .640" ID x .875" OD x .008" thk
- Also included in: Wave Washer Kit (RPI Part #PCK693)

Models: LFIIC, LFIIC-D, LFIIT, LFIIT-D, LFIIW(2), LFIIC, LFIICB, LFIIT & LFIIT-D



RPI Part #RPH242
OEM Part #3323016

FLAT WASHER

- 5 per package
- Size: .640" ID x .875" OD x .035" thk
- Also included in: Wave Washer Kit (RPI Part #PCK693)

Models: LFIIC, LFIIC-D, LFIIT, LFIIT-D, LFIIW(2), LFIIC, LFIICB, LFIIT & LFIIT-D

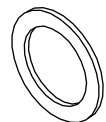

Dental Equipment

Models: LFII & LFIII Series (continued)

RPI Part #PCI806
OEM Part #0460300DW, 0446300LG & 46300PWT



INSULATOR

- Material: White plastic
- Includes all parts as shown
- Fits:** Metal handle to Yoke
- Models:** LFIII, LFIIIC, LFIIICB, LFIIIC-D, LFIIIS, LFIIISE, LFIIIT, LFIIIT-D & LFIIWL

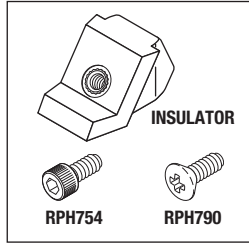

RPI Part #PCI652
OEM Part #015565

INSULATOR

- Material: Black plastic
- Includes all parts as shown
- Fits:** Metal Handle to Yoke
- Model:** LFII

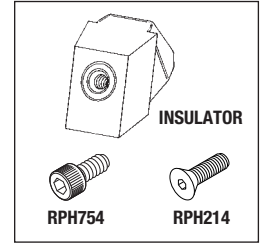

RPI Part #RPH754
OEM Part #94 41 403



SCREW (#10-24 x .375 lg)

- 25 per package
- Material: Stainless steel
- Size: #10-24 x .375" lg. Socket Head Cap Screw
- Also Included in: Insulator (RPI Part #PCI806)
- Fits:** Insulator
- Models:** LFIII, LFIIIC, LFIIICB, LFIIIC-D, LFIIIS, LFIIISE, LFIIIT, LFIIIT-D & LFIIWL

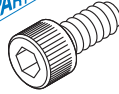

RPI Part #RPH790
OEM Part #33 23 115



SCREW (#10-24 x .500 lg)

- 25 per package
- Material: Stainless Steel
- Size: #10-24 x .500" lg. Oval Head Phillips
- Also Included in: Insulator (RPI Part #PCI806) and Insulator (RPI Part #PCI652)
- Fits:** Insulator
- Models:** LFII, LFIIIC, LFIIIC-D, LFIIIL, LFIIIT, LFIIIT-D, LFIIW, LFIIW (2), LFIIW (3), LFIIII, LFIIIC, LFIIICB, LFIIIC-D, LFIIIS, LFIIISE, LFIIIT, LFIIIT-D & LFIIWL

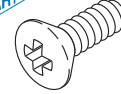

RPI Part #RPH214
OEM Part #3323115 & 090191

FLAT HEAD HEX SOCKET CAP SCREW

- 12 per package
- Material: Black alloy steel
- Size: #10-24 x .500" lg.
- Also Included in: Insulator (RPI Part #PCI652)
- Fits:** Insulator, Front Arm Assembly and Rear Arm
- Models:** LFII, LFIIIL, LFIIW(3), LFIIIC, LFIIIT, LFIIICB & LFIIIT-D

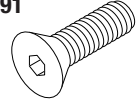

RPI Part #PCA670
OEM Part #3322620 & 014530

ARM ADAPTER

- Material: Aluminum **Not Painted**
- Part is primed and ready to paint
- Includes: Arm Adapter and (2 pcs) Set Screw (RPI Part #RPH208)
- Also available: Drift Kit (RPI Part #PCK651)
- Fits:** Rear Arm to Straight Knuckle (RPI Part #PCK669)
- Models:** LFII, LFIIIC, LFIIIC-D, LFIIII & LFIIIC

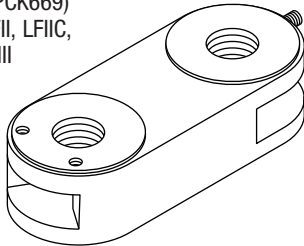

READY TO PAINT!

RPI Part #RPH208
OEM Part #3323123 & 090645

SOCKET HEAD SET SCREW

- 50 per package
- Material: Black alloy steel
- Size: #10-32 x .500" lg.
- Also included in: Arm Adapter (RPI Part #PCA670) & Socket Head Set Screw Kit (RPI Part #RPK118)
- Fits:** Arm Adapter (RPI Part #PCA670)
- Models:** LFII, LFIIIC, LFIIIC-D & LFIIII, LFIIIC

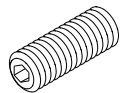

RPI Part #PCS697
OEM Part #3323073 & 026597

KNUCKLE HINGE SCREW

- 2 per package
- Material: Stainless steel
- 7/16-20
- Fits:** Arm adapter and knuckle
- Models:** LFII, LFIIIC, LFIIIC-D, LFIIII & LFIIIC

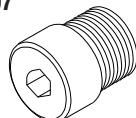

RPI Part #PCK651
OEM Part #006804 (Kit), 016188 & 33.22.992 (Snubbing Pin), 016189 & 33.23.016 (Flat Washer), 017186 & 33.23.008 (Wave Washer)

DRIFT KIT

- Material: Stainless steel
- Includes all parts as shown
- For stabilizing side to side drift
- Also available: Arm Adapter (RPI Part #PCA670) and Straight Knuckle (RPI Part #PCK669)
- Fits:** Arm Adapter and Straight Knuckle
- Models:** LFII, LFIIIC, LFIIW(2), LFIIIC-D, LFIIII, LFIIIC & LFIIIC-D

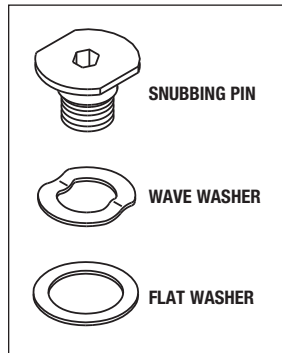

RPI Part #RPA032
OEM Part # (No OEM Part # Available)

THREADLOCKER 242

- .02 fl. oz. (.5 ml)
- Removable adhesive by Loctite®
- Prevents rust and corrosion



RPI Part #PCS686
OEM Part #015597

LAMP REMOVAL SPRING

- 2 per package
- Material: Stainless steel
- Size: .240" OD x .588" lg. x .033" dia. wire
- Fits:** Head Assembly
- Models:** All LFII, LFIIII, LFIIIS & LFIIISE

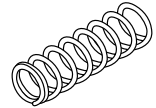

RPI Part #PCS687
OEM Part #015160

FOCUS SPRING

- 2 per package
- Material: Stainless steel
- Size: .300" OD x .570" lg. x .038" dia. wire
- Fits:** Head Assembly
- Models:** All LFII, LFIIII, LFIIIS & LFIIISE

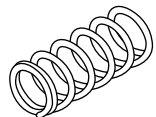

RPI Part #PCS688
OEM Part #015505

RELEASE SPRING

- 2 per package
- Material: Stainless steel
- Size: .182" OD x 1.000" lg. x .016" dia. wire
- Also included in Release Pin Assembly (RPI Part #PCA683)
- Fits:** Head Assembly
- Models:** All LFII, LFIIII, LFIIIS & LFIIISE

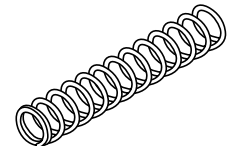

RPI Part #PCT615
OEM Part #016749

SPRING TOOL

- For Gas and Mechanical spring adjustment
- Material: Nickel plated steel
- Size: ~10" lg. x 3-1/4"
- 5/16" hex

Fits: Rear Support Knuckle

Models: ALL LFII & LFIII Series

LOOK!
The RPI Spring Tool has markings right on the tool itself to help you make the correct adjustments to Gas Springs.

This marking indicates the point to STOP when making adjustments to Unit Lights.

This marking indicates the point to STOP when making adjustments to Ceiling Lights.

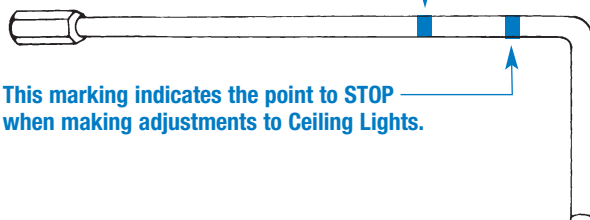

Service Tip

When making adjustments to Gas Springs only -The RPI Spring Tool has special markings right on the tool itself to help you make tension adjustments to the Gas Springs. These markings indicate the maximum distance you should insert and turn the Spring Tool. Using these markings when making adjustments can help you avoid a potential jam. In addition, if you reach these markings and the Gas Springs do not respond, then the Gas Springs must be replaced. **(Important: These markings are not intended for use with Mechanical Springs.)**

RPI Part #PCA700
OEM Part #9439738

MECHANICAL SPRING (UNIT MOUNT)

- Includes all parts as shown
 - Color of spring is white
- Fits:** Lights with Yoke to Straight Knuckle
Models: LFII, LFLII, LFIW(3) & LFIII

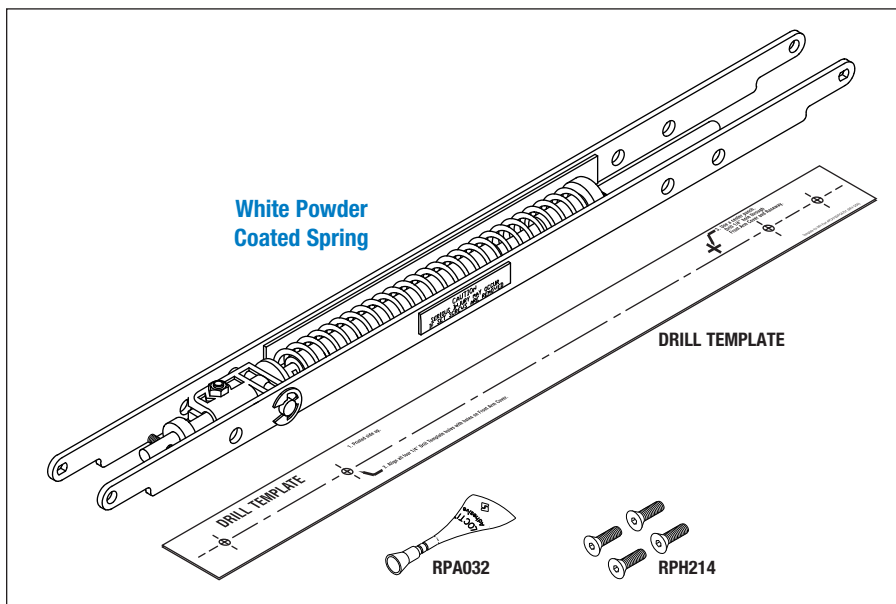

RPI Part #PCA701
OEM Part #1532907

MECHANICAL SPRING (CEILING MOUNT)

- Includes all parts as shown
 - Color of spring is red
- Fits:** Lights with Yoke to Drop Arm
Models: LFIIC, LFIIC-D, LFIIT, LFIIT-D, LFIW(2), LFIIC, LFIIT, LFIIC-D, LFIIT-D & LFIICB

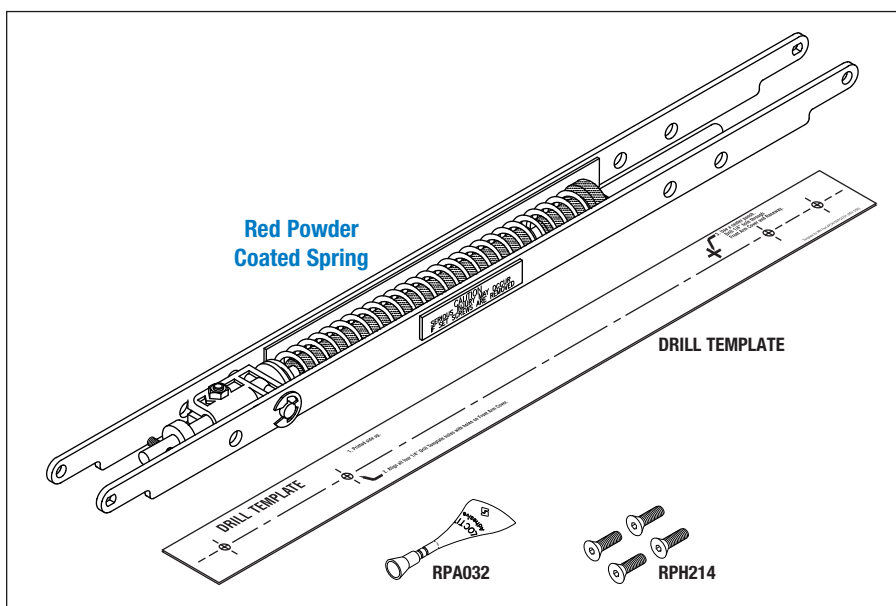

Dental Equipment

Models: LFII & LFIII Series (continued)

RPI Part #PCS601
OEM Part #014140

**GAS SPRING WITH ANCHOR
(CEILING OR TRACK MOUNT)**

- 190 lbs.
- Includes all parts as shown

Fits: Front Arm

Models: LFIIC, LFIIC-D, LFIIT, LFIIT-D & LFIIW(2)

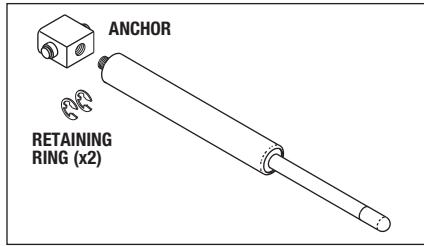

RPI Part #PCS602
OEM Part #017185

**GAS SPRING WITH ANCHOR
(UNIT MOUNT)**

- 170 lbs.
- Includes all parts as shown

Fits: Front Arm

Models: LFII, LFLII & LFWII (3)



SERVICE TIP

If you do not know for certain that the gas spring you are replacing **exactly** matches the RPI Part #PCS601 or PCS602, then – to save time and to be on the safe side – order the appropriate Gas Spring Assembly: RPI Part #PCA653, PCA654, PCA655 or PCA656.

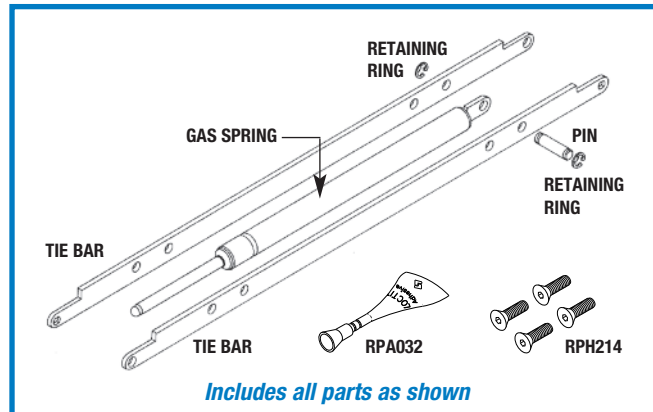

Includes all parts as shown

RPI Part #PCA655
OEM Part #026480

CEILING OR TRACK • 195 LBS.

GAS SPRING ASSEMBLY (CEILING OR TRACK)

- 195 lbs.
- Includes: Gas Spring (Ceiling or Track) (RPI Part #PCS649)

Fits: Front Arm with **plastic** handles

Models: LFIIC, LFIIC-D, LFIIT, LFIIT-D & LFIIW(2)

RPI Part #PCA656
OEM Part #026481

CEILING OR TRACK • 210 LBS.

GAS SPRING ASSEMBLY (CEILING OR TRACK)

- 210 lbs.
- Includes: Gas Spring (Ceiling or Track) (RPI Part #PCS650)

Fits: Front Arm with **metal** handles

Models: LFIIC, LFIIC-D, LFIIT, LFIIT-D & LFIIW(2)

RPI Part #PCA653
OEM Part #026478

UNIT MOUNT • 175 LBS.

GAS SPRING ASSEMBLY (UNIT MOUNT)

- 175 lbs.
- Includes: Gas Spring (Unit Mount) (RPI Part #PCS647)

Fits: Front Arm with **plastic** handles

Models: LFII, LFIIL & LFIIW(3)

RPI Part #PCA654
OEM Part #026479

UNIT MOUNT • 185 LBS.

GAS SPRING ASSEMBLY (UNIT MOUNT)

- 185 lbs.
- Includes: Gas Spring (Unit Mount) (RPI Part #PCS648)

Fits: Front Arm with **metal** handles

Models: LFII, LFIIL & LFIIW(3)

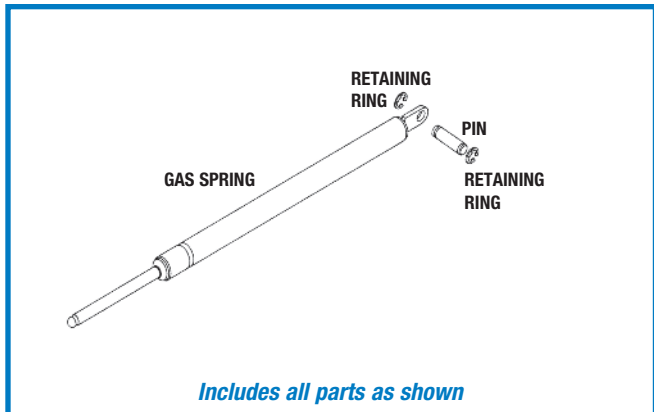

Includes all parts as shown

RPI Part #PCS649
OEM Part #023646

CEILING OR TRACK • 195 LBS.

GAS SPRING (CEILING OR TRACK)

- 195 lbs.
- Replacement for Gas Spring Assembly (RPI Part #PCA655)

Fits: Front Arm with **plastic** handles

Models: LFIIC, LFIIC-D, LFIIT, LFIIT-D & LFIIT(2)

RPI Part #PCS650
OEM Part #023647

CEILING OR TRACK • 210 LBS.

GAS SPRING (CEILING OR TRACK)

- 210 lbs.
- Replacement for Gas Spring Assembly (RPI Part #PCA656)

Fits: Front Arm with **metal** handles

Models: LFIIC, LFIIC-D, LFIIT, LFIIT-D & LFIIW(2)

RPI Part #PCS647
OEM Part #023644

UNIT MOUNT • 175 LBS.

GAS SPRING (UNIT MOUNT)

- 175 lbs.
- Replacement for Gas Spring Assembly (RPI Part #PCA653)

Fits: Front Arm with **plastic** handles

Models: LFII, LFIIL & LFIIW(3)

RPI Part #PCS648
OEM Part #023645

UNIT MOUNT • 185 LBS.

GAS SPRING (UNIT MOUNT)

- 185 lbs.
- Replacement for Gas Spring Assembly (RPI Part #PCA654)

Fits: Front Arm with **metal** handles

Models: LFII, LFIIL & LFIIW(3)

RPI Part #EMB001
OEM Part # (None)

BRUSH

- 2 per package
 - Size: 1/4" x 1/4" x 3/4" long
 - Radius: 1/2"
 - Spring length: 1-1/4"
- Fits:** Brush holder
Model: 92N



RPI Part #RPC037
OEM Part # (None)

BRUSH CAP WITH INSERT

- 6 per package
 - 3/8-24 thread
- Fits:** Brush holder
Model: 92N



RPI is YOUR source
for quality parts!

Ritter Models: C, D, E, F & J

RPI Part #RCB603
OEM Part #374G-3

BRUSH

- 2 per package
 - Size: 3/32" x 1/4" x 1/2" long
 - Bevel: 30°
- Fits:** Ritter Engine
Models: C & D



RPI Part #RCB604
OEM Part #374G37

BRUSH

- 2 per package
 - Size: 1/8" x 1/4" x 1/2" long
 - Bevel: 30°
- Fits:** Ritter Engine
Models: E, F & J



Visit the RPI website:
www.rpiparts.com

Wells

RPI Part #EMB001
OEM Part # E-106

BRUSH

- 2 per package
 - Size: 1/4" x 1/4" x 3/4" long
 - Radius: 1/2"
 - Spring length: 1-1/4"
- Fits:** WSM motor



RPI Part #BDB001
OEM Part #E-107

BRUSH

- 2 per package
 - Size: 1/4" x .190" x 21/32" long
 - Spring length: 1-1/8"
 - Copper shunt wire
- Fits:** Small brush Bodine motor with brush cap that has threaded O.D. and flat brass insert



RPI Part #DRB001
OEM Part #E-105

BRUSH

- 2 per package
 - Size: 1/4" x 3/8" x 15/16"
 - Radius: 5/8"
 - Spring length: 1-1/4"
 - Copper shunt wire
- Fits:** Large brush motor E-131

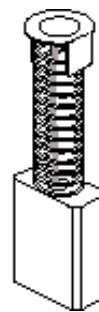

PLASTIC & METAL TUBING SNAKES

Plastic Tubing Snake RPI Part #RPT620

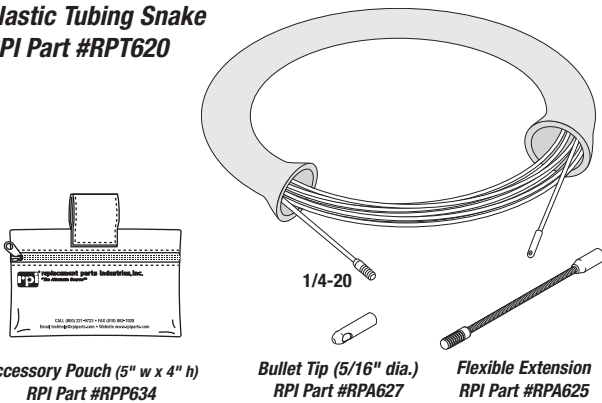

Accessory Pouch (5" w x 4" h)
RPI Part #RPP634

Bullet Tip (5/16" dia.)
RPI Part #RPA627

Flexible Extension
RPI Part #RPA625

Metal Tubing Snake RPI Part #RPT629

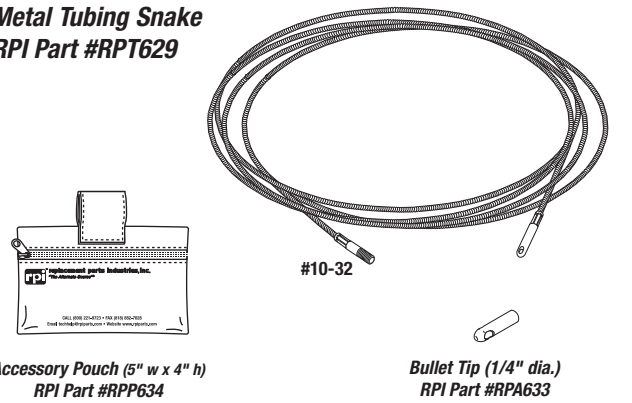

Accessory Pouch (5" w x 4" h)
RPI Part #RPP634

Bullet Tip (1/4" dia.)
RPI Part #RPA633

PLASTIC TUBING SNAKE RPI Part #RPT620



OEM Part #: (No OEM Part # Available)

- 15' of 3/16" dia. non-conductive fiberglass rod with PVC holder
- Includes Bullet Tip (RPI Part #RPA627), Flexible Extension (RPI Part #RPA625), and Accessory Pouch (RPI Part #RPP634)
- One end has fixed 3/16" dia. brass tip with 1/8" dia. hole; Opposite end has a 1/4-20 male thread adapter for adding attachments
- With Connector (RPI Part #RPA621), two Plastic Tubing Snakes can be joined together for those longer reach jobs
- Minimum bend radius: 2.5"

METAL TUBING SNAKE RPI Part #RPT629



OEM Part#: (No OEM Part # Available)

- 12' of 1/8" dia. flex cable
- Includes Bullet Tip (RPI Part #RPA633), and Accessory Pouch (RPI Part #RPP634)
- One end has a fixed 3/16" dia. brass tip with 1/8" dia. hole; Opposite end has a #10-32 male thread adapter for adding attachments
- With Connector (RPI Part #RPA631), two Metal Snakes can be joined together for those longer reach jobs
- Minimum bend radius: 3/4"

FLEXIBLE EXTENSION RPI Part #RPA625



- 3" long

Fits: Plastic Tubing Snake

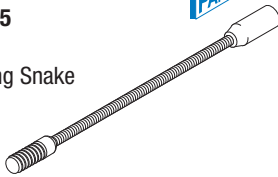

BULLET TIP (5/16" dia.) RPI Part #RPA627



- 5/16" dia. body with 3/16" dia. hole

Fits: Plastic Tubing Snake

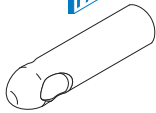

FIBER-OPTIC PULLER (5/16" dia.) RPI Part #RPA623



- Includes (1) #6-32 x 3/32" lg set screw to lock fiber-optic tube in place
- 5/16" dia. Bullet Tip
- 1-3/8" lg.

Fits: Plastic Tubing Snake

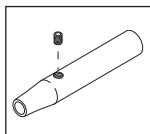

CONNECTOR (PLASTIC SNAKE) RPI Part #RPA621



- Allows two Plastic Snakes to be connected for a 30' reach

Fits: Plastic Tubing Snake

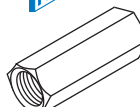

THE ATTACHMENTS SHOWN BELOW FIT BOTH SNAKES!

The Metal Snake requires the Adapter - RPI Part #RPA631

HOOK ATTACHMENT RPI Part #RPA624

- 3-5/8" lg
- Hook: 1-1/8" wide with a .40" wide opening

Fits: Both Snakes (Metal Snake requires Adapter - RPI Part #RPA631)

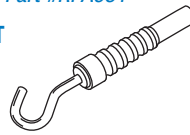

PULLING EYE RING RPI Part #RPA626

- 3/4" dia. pulling ring
- 5/16" dia. body

Fits: Both Snakes (Metal Snake requires Adapter - RPI Part #RPA631)

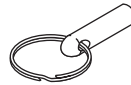

MAGNET ATTACHMENT RPI Part #RPA622

- 15/32" dia. magnet tip

Fits: Both Snakes (Metal Snake requires Adapter - RPI Part #RPA631)



ACCESSORY POUCH RPI Part #RPP634

- 5" w x 4" h
- 600 Denier Polyester
- Velcro® belt-loop flap

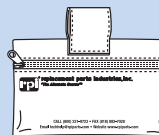

ADAPTER RPI Part #RPA631



- Allows a step-up for use with Plastic Snake attachments (Hook Attachment, Pulling Eye Ring, and Magnet Attachment)

Fits: Metal Snake

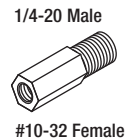

BULLET TIP (1/4" dia.) RPI Part #RPA633



- 1/4" dia. body with 3/16" dia. hole

Fits: Metal Snake

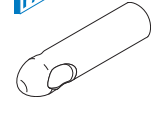

FIBER-OPTIC PULLER (1/4" dia.) RPI Part #RPA630



- Includes (1) #6-32 x 3/32" lg. set screw to lock fiber-optic tube in place
- 1/4" dia. Bullet Tip
- 1-1/8" lg.

Fits: Metal Snake

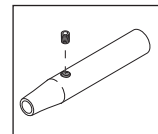

CONNECTOR (METAL SNAKE) RPI Part #RPA632



- Allows two Metal Snakes to be connected for a 24' reach

Fits: Metal Snake

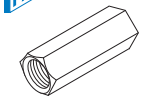

RPI Part #RPT766
OEM Part #32380

TIMER (30 MINUTE)

- 30 minutes with hold
- 15A per pole; 120/240V; DPST
- 1/4" Tabs
- Shaft: .250" dia. x .787 lg; "D" Flat
- Size: ~ 1.968" x 1.791" x 1.145" DP.
- Includes: Mounting screws
- Also available: Knob (RPI Part #TUK050)

Fits: 30 Minute Ultrasonic Cleaner

Models: L&R Ultrasonic Cleaners, Ney (Dentsply) Ultrasonic Cleaners, Patterson Dental Ultrasonic Cleaners & Henry Schein Dental Ultrasonic Cleaners

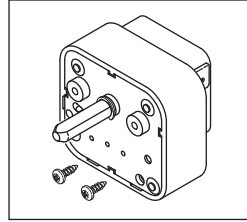

RPI Part #RPT767
OEM Part #40872

TIMER (60 MINUTE)

- 60 minutes without hold
- 15A per pole; 120/240V; DPST
- 1/4" Tabs
- Shaft: .250" dia. x .787 lg; "D" Flat
- Size: ~ 1.968" x 1.791" x 1.145" DP.
- Includes: Mounting screws
- Also available: Knob (RPI Part #TUK050)

Fits: 60 Minute Ultrasonic Cleaner

Models: L&R Ultrasonic Cleaners, Ney (Dentsply) Ultrasonic Cleaners, Patterson Dental Ultrasonic Cleaners & Henry Schein Dental Ultrasonic Cleaners

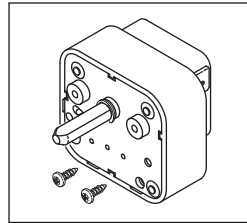

RPI Part #TUK050

OEM Part # (No OEM Part # Available)

KNOB

- Material: Black plastic
- Size: Fits .250" dia. 'D' Shaft; 1.61" OD x .85" tall

Fits: Timer

Models: L&R Ultrasonic Cleaners, Ney (Dentsply) Ultrasonic Cleaners, Patterson Dental Ultrasonic Cleaners & Henry Schein Dental Ultrasonic Cleaners

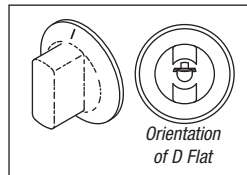

RPI Part #RPS768

OEM Part #32040

SWITCH

- Rocker Switch (on-off)
- 15A @ 250VAC, DPDT
- Illuminated green lens; black body
- Legend: I/O
- 3/16" Tabs
- Includes: Switch Cover (RPI Part #RPC769)
- Used as a Heater Switch or a Power Switch

Fits: Front / Side Panel

Models: L&R Ultrasonic Cleaners, Ney (Dentsply) Ultrasonic Cleaners, Patterson Dental Ultrasonic Cleaners & Henry Schein Dental Ultrasonic Cleaners

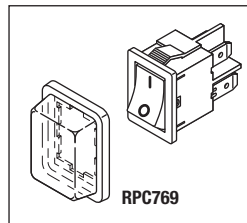

RPI Part #RPC769

OEM Part # (No OEM Part # Available)

SWITCH COVER

- Fits .82" x .59" switch bezel
- This rubber switch cover will extend the life of the switch by preventing moisture from entering into it
- Material: Clear silicone rubber
- Also included in: Switch (RPI Part #RPS768)

Fits: Switch

Models: L&R Ultrasonic Cleaners, Ney (Dentsply) Ultrasonic Cleaners, Patterson Dental Ultrasonic Cleaners & Henry Schein Dental Ultrasonic Cleaners

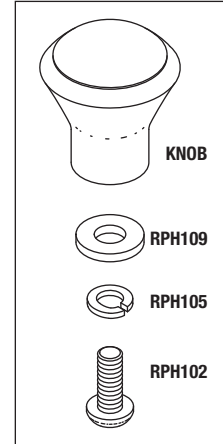
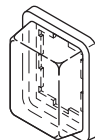

RPI Part #RPK801
OEM Part #40668

KNOB KIT

- Includes all parts as shown

Fits: Lid Cover

Models: L&R Ultrasonic Cleaners, Ney (Dentsply) Ultrasonic Cleaners, Patterson Dental Ultrasonic Cleaners & Henry Schein Dental Ultrasonic Cleaners

RPI Part #RPH109

OEM Part # (No OEM Part # Available)

#10 FLAT WASHER

- 25 per package
- Material: Stainless steel
- Also included in: Knob Kit (RPI Part #RPK801) and Hardware Kit (RPI Part #RPK402)

Fits: Lid Cover

Models: See Knob Kit (RPI Part #RPK801)



RPI Part #RPH105

OEM Part # (No OEM Part # Available)

#8 SPLIT LOCK WASHER

- 50 per package
- Material: Stainless steel
- Also included in: Knob Kit (RPI Part #RPK801) and Hardware Kit (RPI Part #RPK402)

Fits: Lid Cover

Models: See Knob Kit (RPI Part #RPK801)



RPI Part #RPH102

OEM Part # (No OEM Part # Available)

SCREW (8-32 x 1/2)

- 50 per package
- Material: Stainless steel
- Size: #8-32 x 1/2" lg.
- Also included in: Knob Kit (RPI Part #RPK801) and Hardware Kit (RPI Part #RPK402)

Fits: Lid Cover

Models: See Knob Kit (RPI Part #RPK801)

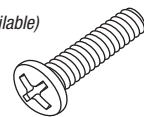

Dental Equipment

Models: L&R, Ney (Dentsply), Patterson Dental and Henry Schein® Dental Ultrasonic Cleaners

RPI Part #RPB640

OEM Part # (No OEM Part # Available)

BUMPER

- 4 per package
- Material: Polyurethane
- Size: ~ 1/2" square x 15/64" H
- Self adhesive backing

Fits: Chassis

Models: L&R Ultrasonic Cleaners, Ney (Dentsply) Ultrasonic Cleaners, Patterson Dental Ultrasonic Cleaners & Henry Schein Dental Ultrasonic Cleaners

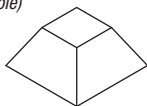

RPI Part #RPH742

OEM Part # (No OEM Part # Available)

PHILLIPS PAN HEAD SCREW #6

- 25 per package
- Material: Zinc plated steel
- Size: #6 self tapping screw x 1/2" lg.

Fits: Chassis

Models: L&R Ultrasonic Cleaners, Ney (Dentsply) Ultrasonic Cleaners, Patterson Dental Ultrasonic Cleaners & Henry Schein Dental Ultrasonic Cleaners

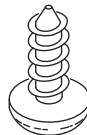

RPI Part #RPC557

OEM Part # (No OEM Part # Available)

HOSPITAL GRADE POWER CORD

- Length: 8 ft.
- 16/3 SJT, 60°C; 13A @ 125VAC
- Plug Type: NEMA 5-15P
- Connector Type: EN60320-C13; gray

Fits: Power Input Module

Models: L&R Ultrasonic Cleaners, Ney (Dentsply) Ultrasonic Cleaners, Patterson Dental Ultrasonic Cleaners & Henry Schein Dental Ultrasonic Cleaners

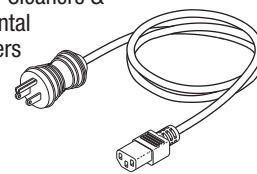

RPI Part #RPH800

OEM Part #32409



FUSE HOLDER

- 3/16" quick connect / solder tabs
- Accommodates metric 5mm x 20mm fuse
- 16A @ 250VAC
- Mounting hole size: .500" dia.
- Includes: mounting hardware

Fits: Rear Panel

Models: L&R Ultrasonic Cleaners, Ney (Dentsply) Ultrasonic Cleaners, Patterson Dental Ultrasonic Cleaners & Henry Schein Dental Ultrasonic Cleaners

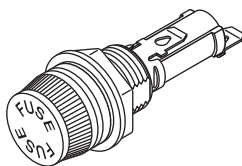

RPI Part #RPC028

OEM Part # (No OEM Part # Available)

HOSPITAL GRADE POWER CORD

- Length: 10 ft.
- 18/3 SJT, 60°C; 10A @ 125VAC
- Plug Type: NEMA 5-15P
- Connector Type: None; gray
- Use Strain Relief Bushing (RPI Part #RPB164) when replacing power cord

Fits: Chassis

Models: L&R Ultrasonic Cleaners, Ney (Dentsply) Ultrasonic Cleaners, Patterson Dental Ultrasonic Cleaners & Henry Schein Dental Ultrasonic Cleaners

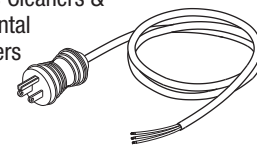

RPI Part #RPK538

OEM Part # (No OEM Part # Available)

FUSE KIT (5mm x 20mm TIME DELAY)

- Most Fuses to fit the variety of Ultrasonic Cleaners on the market can be found in this Kit. Also, see our other Fuse Kits in the General Shop Aids Section of our Catalog
- Kit includes 18-compartment Storage Case (RPI Part #RPB417)
- Fuses are also sold separately in quantities indicated below

Models: L&R Ultrasonic Cleaners, Ney (Dentsply) Ultrasonic Cleaners, Patterson Dental Ultrasonic Cleaners & Henry Schein Dental Ultrasonic Cleaners

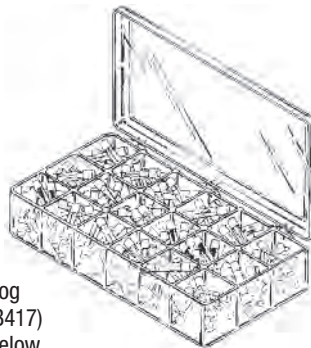

RPI PART #	OEM PART #	AMPS	VOLTS	TYPE	QTY
RPF521	No OEM Part # Available	1/32A	250V	Glass	5
RPF522	No OEM Part # Available	1/20A	250V	Glass	5
RPF523	No OEM Part # Available	1/10A	250V	Glass	5
RPF524	No OEM Part # Available	1/8A	250V	Glass	5
RPF525	No OEM Part # Available	1/5A	250V	Glass	5
RPF368	No OEM Part # Available	1/4A	250V	Glass	5
RPF526	No OEM Part # Available	2/5A	250V	Glass	5
RPF527	No OEM Part # Available	1/2A	250V	Glass	5
RPF528	No OEM Part # Available	4/5A	250V	Glass	5
RPF529	32025	1A	250V	Glass	5
RPF530	No OEM Part # Available	1-1/4A	250V	Glass	5
RPF531	32027	2A	250V	Glass	5
RPF532	32028	2-1/2A	250V	Glass	5
RPF533	No OEM Part # Available	4A	250V	Glass	5
RPF534	32030	5A	250V	Glass	5
RPF535	30125	8A	250V	Glass	5
RPF536	No OEM Part # Available	10A	250V	Glass	5
RPF537	31226	15A	250V	Glass	5

RPI Part #RPB164

OEM Part # (No OEM Part # Available)

STRAIN RELIEF BUSHING

- 8 per package
- Type: SR-6N3-4
- Cord Type: .325" - .360" round cable
- Mounting Hole: 5/8" dia. x 1/8" thk max
- Also available: Strain Relief Bushing Pliers (RPI Part #RPT172)

Fits: Chassis

Models: L&R Ultrasonic Cleaners, Ney (Dentsply) Ultrasonic Cleaners, Patterson Dental Ultrasonic Cleaners & Henry Schein Dental Ultrasonic Cleaners

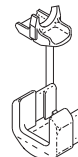

RPI Part #RPT604

OEM Part # (No OEM Part # Available)

DRAIN TUBING

- 1/4" ID x 3/8" OD
- Material: Clear flexible PVC; 68 Duro
- Sold by the foot (reel not included)

Fits: Drain Port

Models: L&R Ultrasonic Cleaners, Ney (Dentsply) Ultrasonic Cleaners, Patterson Dental Ultrasonic Cleaners & Henry Schein Dental Ultrasonic Cleaners

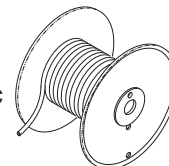

Cavitron® Models: BOBCAT® 25 KHz - G115, BOBCAT® Pro - G130, DualSelect™ Dispensing System - G118, JET Plus™ - G132, JET Plus™ - G137, JET with SPS™ - G120, Plus™ Scaler - G131, Plus™ Scaler - G136, Prophy-JET® Air Polishing System - G122, Prophy-Jet® - G138, Select™ Scaler 25K - G121, Select™ SPS™ 30K - G124, SPS™ Surface Mount Ultrasonic Scaler - G98a, SPS™ Ultrasonic Scaler - G119, & Touch™ Scaler - G1000

For Models These Parts Fit, See Page 1608.

WARNING: Incoming water supply line pressure to the Scaler must be 25 psi (172 kPa) to 60 psi (414 kPa). Water supply line must be shut off or disconnected when Scaler is not in use.

RPI Part #DSK021
OEM Part # (No OEM Part # Available)

WATER FILTER KIT

- Includes all parts as shown
 - See **WARNING** above
 - See **SERVICE TIP** below
- Fits:** Water Supply Line Assembly

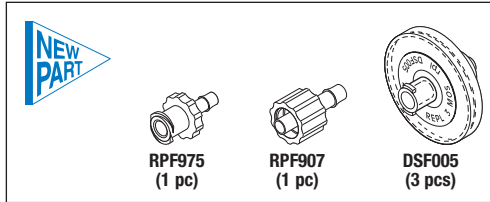

Just need the Disc Filter?



RPI Part #DSF005
OEM Part #90158

DISC FILTER (WATER)

- 10 per package
 - 20 Micron, 25 mm; Ports: Luer lock
 - Maximum Pressure Rating: 60 psi (414 kPa)
 - See **WARNING** above
 - See **SERVICE TIP** below
- Fits:** Luer Lock Fittings on Water Supply Hose Assembly and Water Supply Line Assembly

RPI Part #DSK001
OEM Part #90172

RETROFIT WATER FILTER KIT

- Includes all parts as shown
 - See **WARNING** above
 - See **SERVICE TIP** below
- Fits:** Water Supply Hose Assembly (Braided)

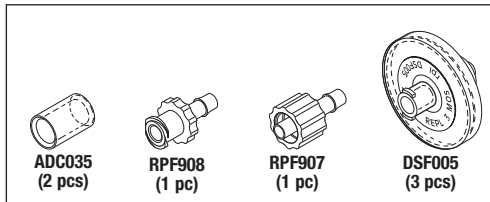

SERVICE TIP: Replace the Disc Filter (Water) (RPI Part #DSF005) every 3 months or when the water filter becomes discolored to prevent reduced water flow to the system.

RPI Part #DSA002
OEM Part #60367

DUCKBILL FILTER ASSEMBLY

- Includes all parts as shown
 - Clear plastic housing with 1/16" barbs, Hex body design for easy replacement of internal parts
- Fits:** Powder Chamber

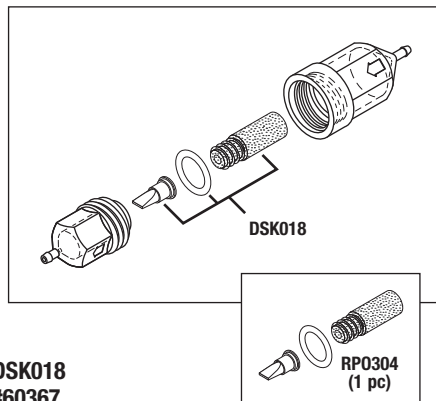

Just need the Repair Kit?

RPI Part #DSK018
OEM Part #60367

REPAIR KIT (DUCKBILL FILTER ASSEMBLY)

- Includes all parts as shown

SERVICE TIP: The Luer Locks below can also be used for water hose in-line connection repairs.

LUER LOCKS (1/8" BARB)

- 10 per package
 - Material: Clear polycarbonate
- Fits:** 1/8" or 3 mm ID tubing



RPI Part #RPF974
OEM Part # (No OEM Part # Available)
LUER LOCK (MALE x 1/8" BARB)

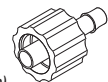

RPI Part #RPF975
OEM Part #621065001
LUER LOCK (FEMALE x 1/8" BARB)

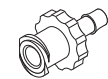

LUER LOCKS (5/32" BARB)

- 10 per package
 - Material: Clear polycarbonate
- Fits:** .150" (4 mm) ID tubing

RPI Part #RPF907
OEM Part #621066001
LUER LOCK (MALE x 5/32" BARB)

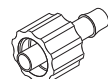

RPI Part #RPF908
OEM Part #621065001
LUER LOCK (FEMALE x 5/32" BARB)

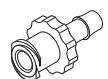

RPI Part #RP0924
OEM Part #62605

O-RING (GREEN)

- 12 per package
 - Size: .145" ID x .285" OD x .070" C/S; Material: Viton®, Duro: 75
- Fits:** Insert Stack Groove; for Insert Types: Classic P, SLI, PEC, Jet Air Polishing Insert, Cavitron MED



RPI Part #RP0342
OEM Part #62351

O-RING (BLACK)

- 12 per package
 - Size: .145" ID x .285" OD x .070" C/S; Material: Viton®, Duro: 75
- Fits:** Insert Stack Groove; for Insert Types: TFI, FSI, FSI-SLI, Bellissima, Cavitron THINsert (Dental Ultrasonic Scalers)



Call Us Toll-Free Monday–Friday, 8:00 AM–4:30 PM (Pacific Time), (800) 221-9723

Dental Equipment

Cavitron® Models: BOBCAT® 25 Khz - G115, BOBCAT® Pro - G130, DualSelect™ Dispensing System - G118, JET Plus™ - G132, JET Plus™ - G137, JET with SPST™ - G120, Plus™ Scaler - G131, Plus™ Scaler - G136, Prophy-JET® Air Polishing System - G122, Prophy-Jet® - G138, Select™ Scaler 25K - G121, Select™ SPST™ 30K - G124, SPST™ Surface Mount Ultrasonic Scaler - G98a, SPST™ Ultrasonic Scaler - G119, & Touch™ Scaler - G100

For Models These Parts Fit, See Page 1608.

WARNING: Incoming water supply line pressure to the Scaler must be 25 psi (172 kPa) to 60 psi (414 kPa). Water supply line must be shut off or disconnected when Scaler is not in use.

RPI Part #DSA047
OEM Part #90125



WATER SUPPLY LINE ASSEMBLY

- Includes all parts as shown
- Replace the Disc Filter (Water) every 3 months or when the Disc Filter (Water) becomes discolored to prevent reduced water flow to the system. The RPI Water Supply Line Assembly includes two (2) extra Disc Filters (Water) plus a PM Log for your convenience.
- See **WARNING** above
- Also available: Disc Filter (Water) (10-pack) (RPI Part #DSF005), Union Fitting (3/16") (RPI Part #DSF048), Male Connector (3/16" Push-In x #10-32 Male) (RPI Part #RPF976), Quick Disconnect, Female (Panel Mount 1/4" Poly) (RPI Part #RPF920), Cord Strap (White 6") (RPI Part #RPS672), and Cord Clip (RPI Part #ADC058)

Fits: 3/16" Push-In Union Fitting(s)/Cavitron to water source

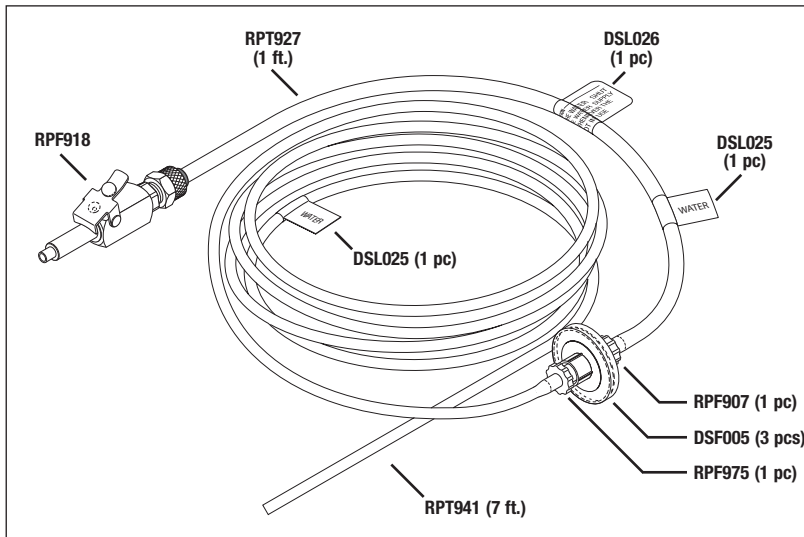

RPI Part #DSA046

OEM Part # (No OEM Part # Available)



WATER SUPPLY HOSE ASSEMBLY (BRAIDED)

- Includes all parts as shown
- Replace the Disc Filter (Water) every 3 months or when the Disc Filter (Water) becomes discolored to prevent reduced water flow to the system. The RPI Water Supply Hose Assembly includes two (2) extra Disc Filters (Water) plus a PM Log for your convenience.
- See **WARNING** above
- Also available: Disc Filter (Water) (10-pack) (RPI Part #DSF005), Quick Disconnect, Female (Panel Mount 1/4" Poly) (RPI Part #RPF920), Cord Strap (White 6") (RPI Part #RPS672), and Cord Clip (RPI Part #ADC058)

Fits: 1/4" Polyflo Fitting/Cavitron to water source

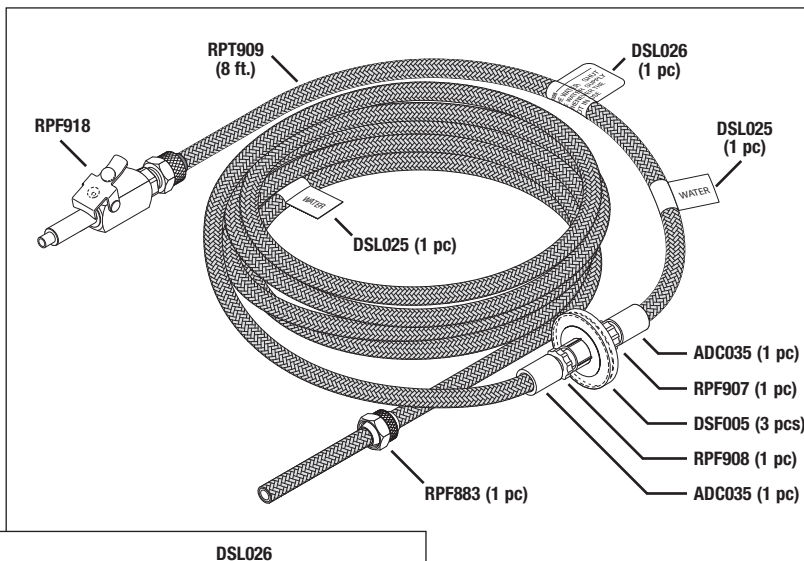

Just need the Water Hose with PolyFlo Nuts and Labels?

RPI Part #DSH003
OEM Part #60388

WATER HOSE (BRAIDED BLUE)

- Includes all parts as shown
- Also available: Male Quick Disconnect (1/4" Poly Auto Shut-Off) (RPI Part# RPF918) and Cord Strap (White 6") (RPI Part #RPS672)

Fits: Cavitron to Water Source

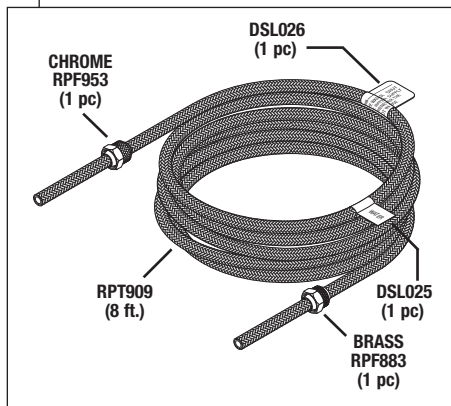

RPI Part #RPS672
OEM Part # (No OEM Part # Available)

CORD STRAP (WHITE 6")

- 3 per package
- Size: .5" wide x 6" lg.
- White strap with white button
- Use to strap air and water supply lines, power cords, cables, and wires

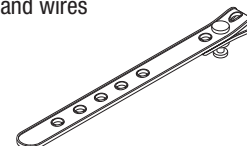

For Water Supply Hose Accessories, See Page 1602.

FAX: (818) 882-7028 • E-MAIL: order@rpiarts.com • WEBSITE: www.rpiarts.com

Cavitron® Models: BOBCAT® 25 KHz - G115, BOBCAT® Pro - G130, DualSelect™ Dispensing System - G118, JET Plus™ - G132, JET Plus™ - G137, JET with SPS™ - G120, Plus™ Scaler - G131, Plus™ Scaler - G136, Prophy-JET® Air Polishing System - G122, Prophy-Jet® - G138, Select™ Scaler 25K - G121, Select™ SPS™ 30K - G124, SPS™ Surface Mount Ultrasonic Scaler - G98a, SPS™ Ultrasonic Scaler - G119, & Touch™ Scaler - G1000

For Models These Parts Fit, See Page 1608.

WATER SUPPLY HOSE ACCESSORIES

RPI Part #RPF918
OEM Part #79521

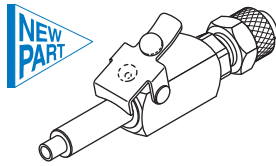

QUICK DISCONNECT, MALE
(1/4" POLY AUTO SHUT-OFF)

- Used with air or water lines
 - Material: Chrome plated brass with auto shut-off
 - Includes: Polyflo Nut (1/4" Chrome) (RPI Part #RPF953)
- Fits:** 1/4" Air and Water Lines

RPI Part #RPF920
OEM Part # (No OEM Part # Available)

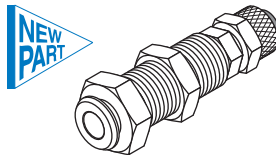

QUICK DISCONNECT, FEMALE
(PANEL MOUNT 1/4" POLY)

- Used with air or water lines
 - Material: Chrome plated brass with auto shut-off
 - Mounting hole size: 1/2" dia.
 - Includes: Polyflo Nut (1/4" Chrome) (RPI Part #RPF953)
- Fits:** 1/4" Air and Water Lines

CHROME

RPI Part #RPF953
OEM Part # (No OEM Part # Available)

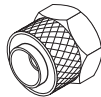

POLYFLO NUT (1/4" CHROME)

- 5 Per package
 - Material: Chrome plated brass
 - Includes: Polyflo Sleeve/Ferrule (1/4") (RPI Part #ADS032)
 - Included in: Water Hose (Braided Blue) (RPI Part #DSH003), Air Hose (Braided Gray) (RPI Part #DSH009), Male Quick Disconnect, (1/4" Poly Auto Shut-Off) (RPI Part #RPF918), and Female Quick Disconnect (1/4" Poly Auto Shut-Off) (RPI Part #RPF920)
- Fits:** Quick Connect to Air or Water Line

BRASS

RPI Part #RPF883
OEM Part # (No OEM Part # Available)



POLYFLO NUT (1/4" BRASS)

- 5 per package
 - Fits: 1/4" OD plastic tube
 - Material: Brass
 - Includes: Polyflo Sleeve/Ferrule (1/4") (RPI Part #ADS032)
 - Included in: Water Hose (Braided Blue) (RPI Part #DSH003), Air Hose (Braided Gray) (RPI Part #DSH009), and Water Supply Hose Assembly (Braided) (RPI Part #DSA046)
- Fits:** Water and Air Hoses

RPI Part #ADS032
OEM Part # (No OEM Part # Available)



POLYFLO SLEEVE/FERRULE (1/4")

- 25 per package
 - 1/4" Polyflo black plastic
- Fits:** 1/4" OD Tubing, Polyflo Nuts

RPI Part #DSL025
OEM Part # (No OEM Part # Available)

WATER WATER

LABEL (WATER)

- 3 per package
- Included in: Water Supply Line Assembly (RPI Part #DSA047), Water Supply Hose Assembly (Braided) (RPI Part #DSA046), and Water Hose (Braided Blue) (RPI Part #DSH003)

RPI Part #DSL026
OEM Part # (No OEM Part # Available)

CAUTION
ALWAYS CLOSE THE WATER SHUT OFF VALVE IN THE WATER SUPPLY TO THE UNIT WHENEVER THE UNIT IS NOT IN USE.

LABEL (CAUTION)

- 3 per package
- Included in: Water Supply Line Assembly (RPI Part #DSA047), Water Supply Hose Assembly (Braided) (RPI Part #DSA046), and Water Hose (Braided Blue) (RPI Part #DSH003)

TUBING (.107" ID x 3/16" OD BLUE)

- Available by the foot or in a box of 100 ft.
 - Size: .107" ID x 3/16" OD blue polyurethane
- Fits:** 1/8" Barb or 3/16" Push-in Fitting

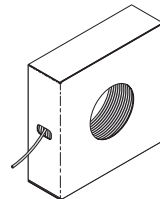

Just Ask For:

RPI Part #RPT941
TUBING (.107" ID x 3/16" OD BLUE) - Sold by the Foot



RPI Part #RXT001
TUBING (.107" ID x 3/16" OD BLUE) - Box of 100 ft.

TUBING (.160" ID x 1/4" OD BLUE)

- Available by the foot or in a box of 100 ft.
 - Size: .160" ID x 1/4" OD blue polyurethane
- Fits:** 1/4" Polyflo Fitting, 1/4" Push-in Fitting, and 5/32" Luer Lock Barb fitting

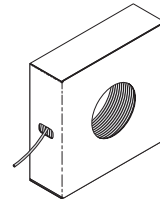

Just Ask For:



RPI Part #RPT927
TUBING (.160" ID x 1/4" OD BLUE) - Sold by the Foot



RPI Part #RPT999
TUBING (.160" ID x 1/4" OD BLUE) - Box of 100 ft.

BRAIDED TUBING (1/4" OD BLUE)

- Available by the foot or in a box of 100 ft.
 - Size: .150" ID x .250" OD PVC tubing with blue over braided sleeve
- Fits:** 1/4" Polyflo or 5/32" Barb

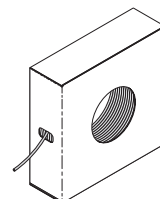

Just Ask For:

RPI Part #RPT909
BRAIDED TUBING (1/4" OD BLUE) - Sold by the Foot

RPI Part #RPT910
BRAIDED TUBING (1/4" OD BLUE) - Box of 100 ft.

Call Us Toll-Free Monday-Friday, 8:00 AM-4:30 PM (Pacific Time), (800) 221-9723

Dental Equipment

Cavitron® Models: BOBCAT® 25 KHz - G115, BOBCAT® Pro - G130, DualSelect™ Dispensing System - G118, JET Plus™ - G132, JET Plus™ - G137, JET with SPST™ - G120, Plus™ Scaler - G131, Plus™ Scaler - G136, Prophy-JET® Air Polishing System - G122, Prophy-Jet® - G138, Select™ Scaler 25K - G121, Select™ SPST™ 30K - G124, SPST™ Surface Mount Ultrasonic Scaler - G98a, SPST™ Ultrasonic Scaler - G119, & Touch™ Scaler - G100

For Models These Parts Fit, See Page 1608.

**RPI Part #DSA008
OEM Part #63856**

HOSE ASSEMBLY & FILTER (AIR)

- Includes all parts as shown
- Also available: Braided Tubing (1/4" OD Gray) (Box of 100 ft.) (RPI Part #RPT912), Braided Tubing (1/4" OD Gray) (RPI Part #RPT911) - sold by the foot, Quick Disconnect, Female (Panel Mount 1/4" Poly) (RPI Part #RPF920), Cord Strap (White 6") (RPI Part #RPS672), and Cord Clip (RPI Part #ADC058)

Fits: Cavitron to Air Source

Just need the Air Hoses with PolyFlo Nuts and Labels?

**RPI Part #DSH009
OEM Part #80786**

AIR HOSE (BRAIDED GRAY)

- Includes all parts as shown
- Also available: Braided Tubing (1/4" OD Gray) (Box of 100 ft.) (RPI Part #RPT912), Braided Tubing (1/4" OD Gray) (RPI Part #RPT911) - sold by the foot, Cord Strap (White 6") (RPI Part #RPS672), and Cord Clip (RPI Part #ADC058)

Fits: Cavitron to Air Source

RPI Part #DSL024

OEM Part # (No OEM Part # Available)

LABEL (AIR)

- 3 per package
- Included in: Hose Assembly & Filter (Air) (RPI Part #DSA008) and Air Hose (Braided Gray) (RPI Part #DSH009)



**RPI Part #RPA915
OEM Part #90088**

AIR FILTER SSEMBLY

- Ports: #10-32 (M5 x 0.8)
- Manual drain
- Includes all parts as shown

Fits: Air Source to Cavitron/ 1/4" Polyflo Air Hose

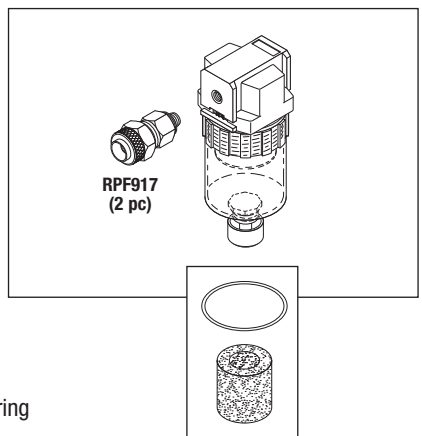

Just need the Filter Element?

RPI Part #RPE916

OEM Part # (No OEM Part # Available)

FILTER ELEMENT

- 5 Micron
- Includes: Filter element and O-ring

Fits: Air Filter Assembly

Just need the PolyFlo Fitting?

RPI Part #RPF917

OEM Part # (No OEM Part # Available)

POLYFLO FITTING (1/4" TUBE x #10-32 MALE)

- 5 per package
- Material: Brass with rubber sealing washer
- For use with most plastic and soft metal tubing

Fits: Air Filter Assembly

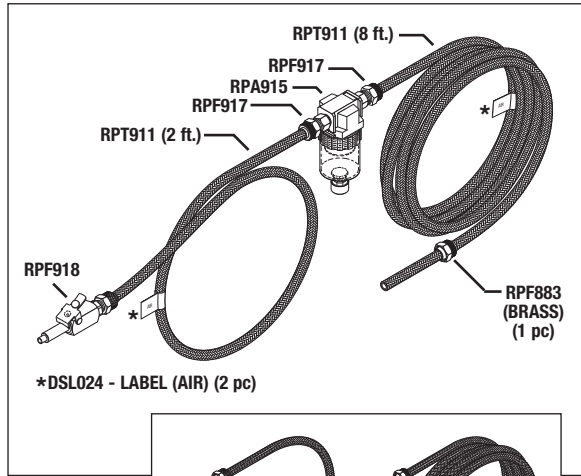
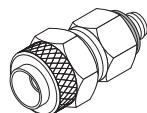

*DSL024 - LABEL (AIR) (2 pc)

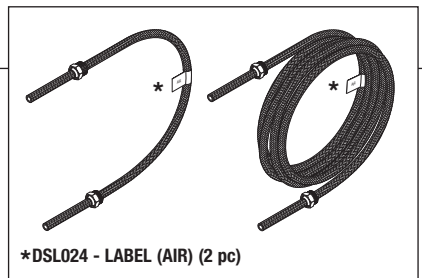

*DSL024 - LABEL (AIR) (2 pc)

RPI Part #RPS672

OEM Part # (No OEM Part # Available)

CORD STRAP (WHITE 6")

- 3 per package
- Size: .5" wide x 6" lg.
- White strap with white button
- Use to strap air and water supply lines, power cords, cables, and wires

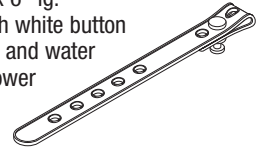

SERVICE TIP: These Quick Disconnects can be used for your Air and Water Lines.

RPI Part #RPF918

OEM Part #79521



QUICK DISCONNECT, MALE (1/4" POLY AUTO SHUT-OFF)

- Used with air or water lines
- Material: Chrome plated brass with auto shut-off
- Includes: Polyflo Nut (1/4" Chrome) (RPI Part #RPF953)

Fits: 1/4" Air and Water Lines

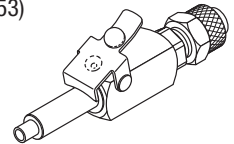

RPI Part #RPF920

OEM Part # (No OEM Part # Available)



QUICK DISCONNECT, FEMALE (PANEL MOUNT 1/4" POLY)

- Used with air or water lines
- Material: Chrome plated brass with auto shut-off
- Mounting hole size: 1/2" dia.
- Includes: Polyflo Nut (1/4" Chrome) (RPI Part #RPF953)

Fits: 1/4" Air and Water Lines

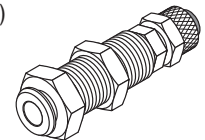

BRAIDED TUBING (1/4" OD GRAY)

- Available by the foot or in a box of 100 ft.
- Size: .150" ID x .250" OD PVC tubing with gray over braided sleeve

Fits: 1/4" Polyflo or 5/32" Barb

Just Ask For:

**RPI Part #RPT911
BRAIDED TUBING (1/4" OD GRAY) - Sold by the Foot**

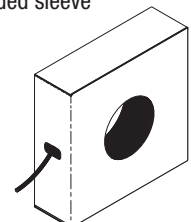

**RPI Part #RPT912
BRAIDED TUBING (1/4" OD GRAY) - Box of 100 ft.**

Cavitron® Models: BOBCAT® 25 KHz - G115, BOBCAT® Pro - G130, DualSelect™ Dispensing System - G118, JET Plus™ - G132, JET Plus™ - G137, JET with SPST™ - G120, Plus™ Scaler - G131, Plus™ Scaler - G136, Prophy-JET® Air Polishing System - G122, Prophy-Jet® - G138, Select™ Scaler 25K - G121, Select™ SPST™ 30K - G124, SPST™ Surface Mount Ultrasonic Scaler - G98a, SPST™ Ultrasonic Scaler - G119, & Touch™ Scaler - G1000

FOOT CONTROLS

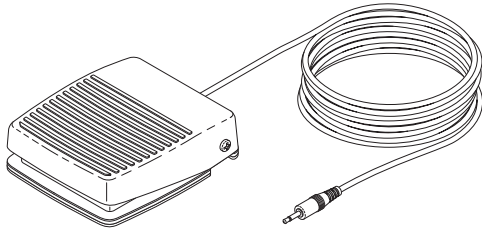

RPI Part #DSF012
OEM Part #565162005

FOOT CONTROL

- 2 Switch boost feature
- 8 foot long black #22 AWG shielded cord with .097" diameter pin molded plug
- Size: 3.44" W x 4.00" L x 1.09" H
- Non-skid base and raised ribs on pedal for positive traction

Fits: Cavitron G124

Model: Cavitron® Select™ SPST™ 30K - G124

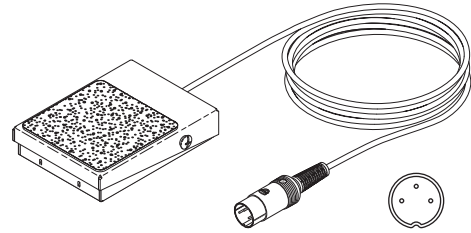

RPI Part #DSF039
OEM Part #77885

FOOT CONTROL

- Single switch position
- 8 foot long gray #24 AWG shielded cord with 3 pin round plug
- Size: 2.63" W x 3.53" L x .85" H
- Non-skid base and pedal for positive traction

Fits: Cavitron G115

Model: Cavitron® BOBCAT® 25 KHz - G115

3 PIN
CONFIGURATION

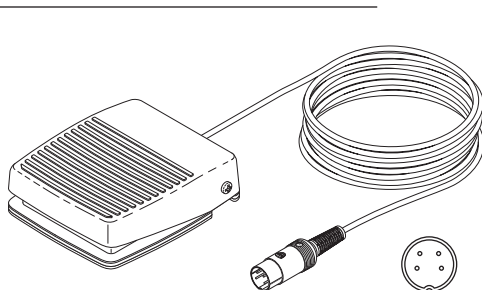

RPI Part #DSF013
OEM Part #565138002, 565138003

FOOT CONTROL

- 2 Switch boost feature
- 8 foot long gray #24 AWG shielded cord with 4 pin round plug
- Size: 3.44" W x 4.00" L x 1.09" H
- Non-skid base and raised ribs on pedal for positive traction

Fits: Cavitrons G119, G120, & G122

Models: Cavitron® SPST™ Ultrasonic Scaler - G119, Cavitron® JET with SPST™ - G120, and Cavitron® Prophy-JET® Air Polishing System - G122

4 PIN
CONFIGURATION

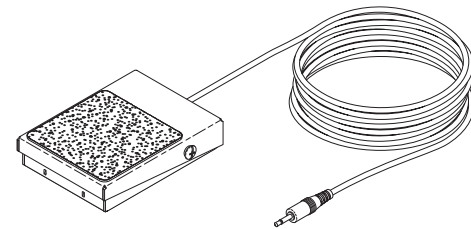

RPI Part #DSF040
OEM Part #565162002

FOOT CONTROL

- Single switch position
- 8 foot long black #22 AWG shielded cord with .097" diameter pin molded plug
- Size: 2.63" W x 3.53" L x .85" H
- Non-skid base and pedal for positive traction

Fits: Cavitron G121

Model: Cavitron® Select™ Scaler 25K - G121

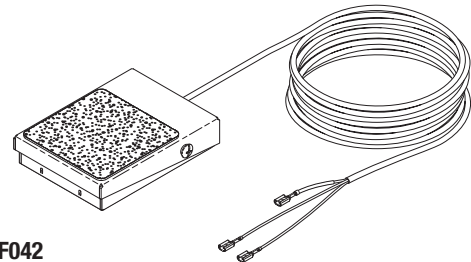

RPI Part #DSF042
OEM Part #565162006

FOOT CONTROL

- Single switch position
- 8 foot long gray #24 AWG shielded cord, three wire with 3/16" quick connect terminals
- Size: 2.63" W x 3.53" L x .85" H
- Non-skid base and pedal for positive traction

Fits: Cavitron G130

Model: Cavitron® BOBCAT® Pro - G130

Dental Equipment

Cavitron® Models: BOBCAT® 25 KHz - G115, BOBCAT® Pro - G130, DualSelect™ Dispensing System - G118, JET Plus™ - G132, JET Plus™ - G137, JET with SPST™ - G120, Plus™ Scaler - G131, Plus™ Scaler - G136, Prophy-JET® Air Polishing System - G122, Prophy-Jet® - G138, Select™ Scaler 25K - G121, Select™ SPST™ 30K - G124, SPST™ Surface Mount Ultrasonic Scaler - G98a, SPST™ Ultrasonic Scaler - G119, & Touch™ Scaler - G100

For Models These Parts Fit, See Page 1608.

WATER SOLENOID VALVES

**RPI Part #DSV006
OEM Part #571070003**

SOLENOID VALVE (WATER)

- Ports: 1/8" FPT; 2 way; N.C.
 - 24VDC, 60Hz., 3W; 6" lg. wires with 2 pin connector
 - Material: Stainless steel body; Viton® seals
 - Includes all parts as shown
- Fits:** Water Chassis

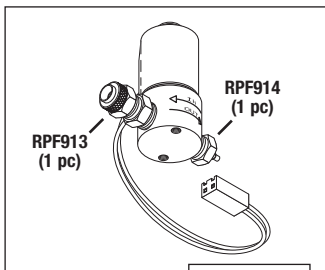

Just need the Repair Kit?

RPI Part #DSK016

OEM Part # (No OEM Part # Available)

SOLENOID VALVE REPAIR KIT

- Includes: Plunger with spring and O-ring
 - Also available: Double Ended Spanner Wrench (RPI Part #RPT501)
- Fits:** Solenoid Valve (Water)

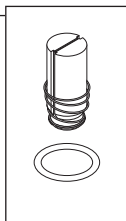

Just need the Coil?

RPI Part #DSC017

OEM Part # (No OEM Part # Available)

COIL (SOLENOID VALVE)

- 24VDC, 3W (488Ω), 6" lg. wires with 2 pin connector
- Fits:** Solenoid Valve (Water)

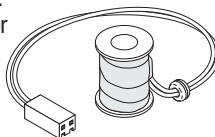

**RPI Part #DSV015
OEM Part #571070002**

SOLENOID VALVE (WATER)

- Ports: 1/8" FPT; 2 way; N.C.
 - 24VDC, 60Hz., 3W; 6" lg. wires with 2 pin connector
 - Material: Stainless steel body; Viton® seals
 - Includes all parts as shown
- Fits:** Water Chassis

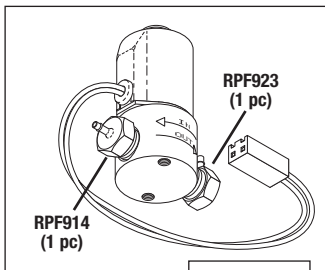

Just need the Repair Kit?

RPI Part #DSK016

OEM Part # (No OEM Part # Available)

SOLENOID VALVE REPAIR KIT

- Includes: Plunger with spring and O-ring
 - Also available: Double Ended Spanner Wrench (RPI Part #RPT501)
- Fits:** Solenoid Valve (Water)

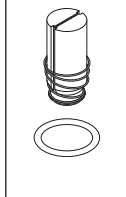

Just need the Coil?

RPI Part #DSC017

OEM Part # (No OEM Part # Available)

COIL (SOLENOID VALVE)

- 24VDC, 3W (488Ω), 6" lg. wires with 2 pin connector
- Fits:** Solenoid Valve (Water)

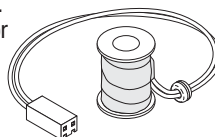

**RPI Part #DSV019
OEM Part #81258**

SOLENOID VALVE (WATER)

- Ports: 1/8" FPT; 2 way; N.C.
 - 24VAC, 50-60Hz., 6W; 6" lg. wires with 2 pin connector
 - Material: Brass body; Buna N seals
 - Includes all parts as shown
- Fits:** Transformer Mount and Lavage Assembly

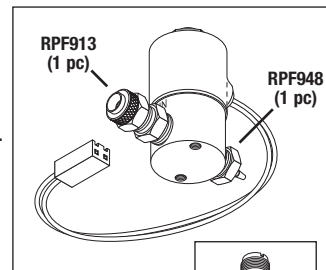

Just need the Repair Kit?

RPI Part #DSK020

OEM Part # (No OEM Part # Available)

SOLENOID VALVE REPAIR KIT

- Includes: Plunger with spring, O-ring and bonnet
- Fits:** Solenoid Valve (Water)

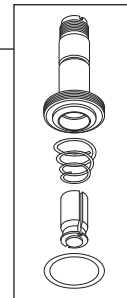

RPI Part #RPF913

OEM Part # (No OEM Part # Available)

POLYFLO FITTING (1/4" TUBE x 1/8" MPT)

- 5 per package
 - Material: Brass body with plastic sleeve/ferrule
 - Also available: Polyflo Nut (RPI Part #RPF883)
 - Included in: Solenoid Valve (Water) (RPI Part #'s DSV006 & DSV019)
- Fits:** 1/4" OD Plastic Tubing x 1/8" FPT Ports

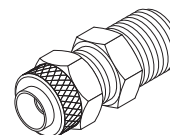

RPI Part #RPF914

OEM Part # (No OEM Part # Available)

ADAPTOR (1/16" BARB x 1/8" MPT)

- 5 per package
 - Material: Brass
 - Included in: Solenoid Valve (Water) (RPI Part #'s DSV006 & DSV015)
- Fits:** 1/16" ID Plastic Tubing x 1/8" FPT Ports

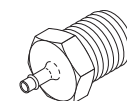

RPI Part #RPF923

OEM Part #63827

ADAPTOR ELBOW (1/16" BARB x 1/8" MPT)

- 5 per package
 - Material: Brass
 - Included in: Solenoid Valve (Water) (RPI Part #DSV015)
- Fits:** 1/16" ID Plastic Tubing x 1/8" FPT Port



RPI Part #RPF948

OEM Part # (No OEM Part # Available)

ADAPTOR (1/16" BARB x 1/8" MPT)

- 5 per package
 - Material: Nickel plated brass
 - See the special **NOTE** to the right
 - Included in: Solenoid Valve (Water) (RPI Part #DSV019)
- Fits:** 1/16" ID Plastic Tubing x 1/8" FPT Ports

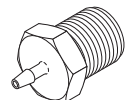

NOTE: This Adaptor has a unique orifice that allows for the precise control of the solenoid valve output.

Cavitron® Models: BOBCAT® 25 KHz - G115, BOBCAT® Pro - G130, DualSelect™ Dispensing System - G118, JET Plus™ - G132, JET Plus™ - G137, JET with SPST™ - G120, Plus™ Scaler - G131, Plus™ Scaler - G136, Prophy-JET® Air Polishing System - G122, Prophy-Jet® - G138, Select™ Scaler 25K - G121, Select™ SPST™ 30K - G124, SPST™ Surface Mount Ultrasonic Scaler - G98a, SPST™ Ultrasonic Scaler - G119, & Touch™ Scaler - G1000

For Models These Parts Fit, See Page 1608.

SOLENOID VALVE (PINCH)

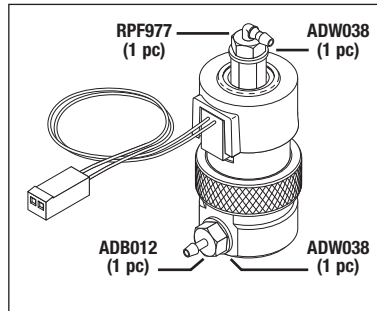

RPI Part #DSV011
OEM Part #629194002

SOLENOID VALVE (PINCH)

- Ports: #10-32 Female
 - 24 VDC, 0.67 W, 0.86 Ω, 4.50" lg. wires with 2 pin connector
 - Includes all parts as shown
 - Also available: Pinch Tubing (RPI Part #RXT016)
- Fits:** Chassis Bracket

RPI Part #RPF977
OEM Part #6390253



ELBOW FITTING (1/16" BARB x #10-32 MALE)

- 10 per package; Material: Natural polypropylene
- Fits:** Pinch Valve and Manifold Regulator Assembly



RPI Part #RXT016
OEM Part #61631



PINCH TUBING (1/16" ID x 1/8" OD RED)

- Sold by the foot (reel not included)
 - Material: Red PVC
 - Also available: Uni-Clamp (RPI Part #ADC034) and Sleeve Clamp (1/8") (RPI Part #RXC023)
- Fits:** Pinch Valves, 1/16" Barb Fittings

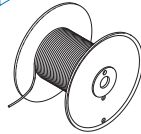

RPI Part #ADB012
OEM Part # (No OEM Part # Available)

BARB (1/16" BARB x #10-32 MALE)

- 10 per package; Nickel plated brass
- Fits:** 1/16" ID Tubing

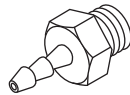

RPI Part #ADW038
OEM Part # (No OEM Part # Available)

FLAT WASHER

- 50 per package; Material Nylon®
 - Size: .187" ID x .312" OD x .031" thk
- Fits:** #10-32 male thread port



CHECK VALVE KIT

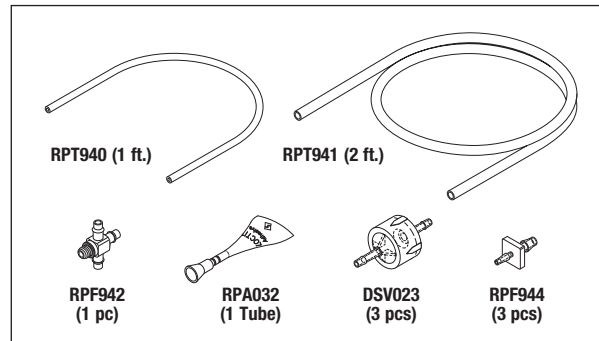

RPI Part #DSK022
OEM Part #81167

CHECK VALVE KIT

- Includes all parts as shown
 - All parts also sold separately
 - This is an upgrade kit for units without check valves or with dual metallic check valves installed
- Fits:** Mounting Plate Assembly

RPI Part #DSV023
OEM Part #629211001

CHECK VALVE

- 3 per package
 - Size: .67" OD x .46" lg. body with 1/8" hose barbs
 - Material: Clear plastic body, silicone diaphragm
 - Temperature: 180°F max; Pressure: 50 PSI max
- Fits:** Mounting Plate Assembly

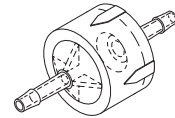

RPI Part #RPF942
OEM Part #623064002

CROSS FITTING (1/8" BARB x #10-32 MALE)

- 5 per package
 - Material: Nickel plated brass
 - Includes: Sealing washer
- Fits:** Quick Connect to Bottle "A" and 1/8" ID Tubing

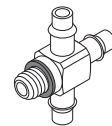

RPI Part #RPF944
OEM Part #621068001

ADAPTOR FITTING (1/16" BARB x 1/8" BARB)

- 10 per package
 - Material: Clear polypropylene
- Fits:** 1/16" ID and 1/8" ID Tubing

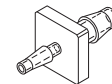

RPI Part #ADC034
OEM Part # (No OEM Part # Available)

UNI-CLAMP

- 20 per package; Material: Plastic
 - Also available: Universal Sleeve Tool (RPI Part #RPT296)
- Fits:** 1/8" OD Tubing with 1/16" Barb



RPI Part #RXC023
OEM Part # (No OEM Part # Available)

SLEEVE CLAMP (1/8")

- 20 per package; Material: Plastic
 - Also available: Universal Sleeve Tool (RPI Part #RPT296)
- Fits:** 1/8" OD Tubing with 1/16" Barb



RPI Part #ADC035
OEM Part # (No OEM Part # Available)

SLEEVE CLAMP

- 20 per package; Material: Plastic
 - Included in: Retrofit Water Filter kit (RPI Part #DSK001)
 - Also available: Universal Sleeve Tool (RPI Part #RPT296)
- Fits:** 1/4" OD Tubing with 1/8" Barb

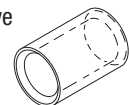

Dental Equipment

Cavitron® Models: BOBCAT® 25 KHz - G115, BOBCAT® Pro - G130, DualSelect™ Dispensing System - G118, JET Plus™ - G132, JET Plus™ - G137, JET with SPS™ - G120, Plus™ Scaler - G131, Plus™ Scaler - G136, Prophy-JET® Air Polishing System - G122, Prophy-Jet® - G138, Select™ Scaler 25K - G121, Select™ SPS™ 30K - G124, SPS™ Surface Mount Ultrasonic Scaler - G98a, SPS™ Ultrasonic Scaler - G119, & Touch™ Scaler - G100

For Models These Parts Fit, See Page 1608.

NEEDLE VALVE (WATER)

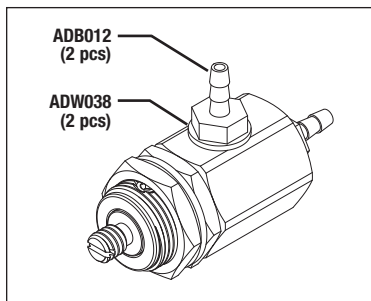

RPI Part #DSV027
OEM Part #629202001



NEEDLE VALVE (WATER)

- Ports: #10-32 Female with 1/16" barb fittings
- Material: Nickel plated brass
- Includes all parts as shown
- Fits:** Front panel

TUBING (1/16" ID)

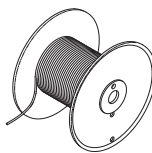

RPI Part #RPT973
OEM Part #625072001

TUBING (1/16" ID x 3/16" OD BLACK)

- Material: Hi-Temp Black Viton
- Ratings: -30°F to 400°F max
- Sold by the foot (reel not included)
- Fits:** 1/16" Barb Fittings

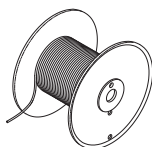

RPI Part #RPT940
OEM Part #61963

TUBING (1/16" ID x 1/8" OD CLEAR)

- Material: Polyurethane
- Sold by the foot (reel not included)
- Fits:** 1/16" Barb Fittings

SERVICE TIP: Use with Tubing (.107" ID x 3/16" OD Blue) (RPI Part #RPT941)

360° Swivel Action!

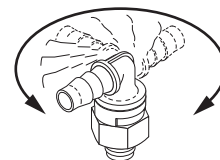

RPI Part #RPF978
OEM Part # (No OEM Part # Available)



SWIVEL ELBOW (1/8" BARB x #10-32 MALE)

- 2 per package; Black Nylon®
- Also available: Flat Washer (Nylon) (RPI Part #ADW038)
- See **Service Tip** above
- Fits:** Solenoid Valve, #10-32 Female Ports

RPI Part #RPF976
OEM Part # (No OEM Part # Available)



MALE CONNECTOR (3/16" PUSH-IN x #10-32 MALE)

- 2 per package; Nickel plated brass
- Note: This fitting has an internal hex and will require a 3/32" Hex Key for installation.
- See **Service Tip** above
- Fits:** Solenoid Valve to Water Source

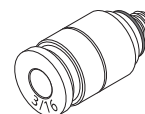

TRANSISTOR, FUSES & POWER CORDS

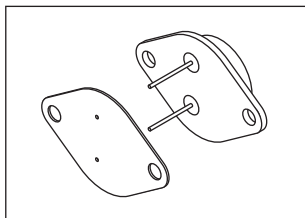

RPI Part #DST014
OEM Part #574335001, 61350

TRANSISTOR

- Includes: Darlington transistor and insulation gasket
- Fits:** Electrical Chassis

RPI Part #RPF922
OEM Part #60537

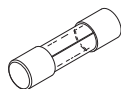

FUSE (630MA, 250V) 5MM x 20MM TIME DELAY

- 5 per package; Type: Glass
- For use with **220V units**
- Fits:** PCB Fuse Holder

RPI Part #RPF524
OEM Part #557034018

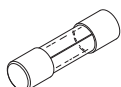

FUSE (1/8A, 250V) 5MM x 20MM TIME DELAY

- 5 per package; Type: Glass
- For use with **120V units**
- Fits:** Power Entry Module

- Color: Gray
- Plug: NEMA 5-15P
- Connector: EN60320-C13
- Also available: Cord Strap (White 6") (RPI Part #RPS672)
- Fits:** Power Input Module

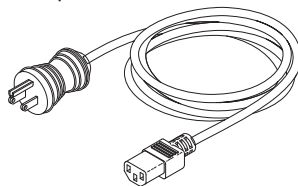

RPI Part #RPC557
OEM Part #554102003

HOSPITAL GRADE POWER CORD (13A @ 125VAC, 8 ft.)

- Length: 8 ft. • 16/3 SJT, 105°C

RPI Part #RPC869
OEM Part # (No OEM Part # Available)

HOSPITAL GRADE POWER CORD (13A @ 125VAC, 3 ft.)

- Length: 3 ft. • 16/3 SJT, 105°C

RPI Part #RPC868
OEM Part # (No OEM Part # Available)

HOSPITAL GRADE POWER CORD (13A @ 125VAC, 1.5 ft.)

- Length: 1.5 ft. • 16/3 SJT, 105°C

RPI Part #DSF048
OEM Part #623072001



UNION CONNECTOR (3/16" PUSH-IN)

- Includes all parts as shown
- See **Service Tip** above
- Fits:** Chassis Bracket to 3/16" OD Water Supply Line

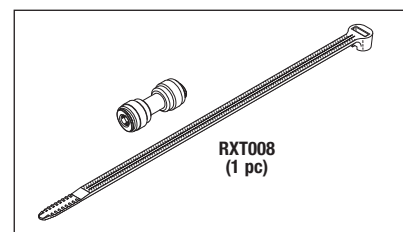

RPI Part #RXT008
OEM Part #712-00004



CABLE TIE (.270" W x 8.75" lg. WHITE)

- 25 per package
- Bundle dia.: .16" min/2.00" max
- Fits:** Union Connector 3/16" to Chassis Bracket

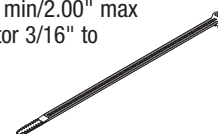

Cavitron® Models: BOBCAT® 25 KHz - G115, BOBCAT® Pro - G130, DualSelect™ Dispensing System - G118, JET Plus™ - G132, JET Plus™ - G137, JET with SPST™ - G120, Plus™ Scaler - G131, Plus™ Scaler - G136, Prophy-JET® Air Polishing System - G122, Prophy-Jet® - G138, Select™ Scaler 25K - G121, Select™ SPST™ 30K - G124, SPS™ Surface Mount Ultrasonic Scaler - G98a, SPS™ Ultrasonic Scaler - G119, & Touch™ Scaler - G1000

Complete list of RPI Parts to fit Dentsply Cavitron® Ultrasonic Scalers!

RPI Part #	OEM Part #	Description	BOBCAT® 25 KHz - G115	BOBCAT® Pro - G130	DualSelect™ Dispensing System - G118	JET Plus™ - G132	JET Plus™ - G137	JET with SPST™ - G120	Plus™ Scaler - G131	Plus™ Scaler - G136	Prophy-JET® Air Polishing System - G122	Prophy-Jet® - G138	Select™ Scaler 25K - G121	Select™ SPST™ 30K - G124	SPS™ Surface Mount Ultrasonic Scaler - G98a	SPS™ Ultrasonic Scaler - G119	Touch™ Scaler - G1000
ADB012	No OEM Part # Available	Barb - 10/pkg															
ADC034	No OEM Part # Available	Uni-Clamp - 20/pkg															
ADC035	No OEM Part # Available	Sleeve Clamp - 20/pkg															
ADC058	No OEM Part # Available	Cord Clip - 10/pkg															
ADS032	No OEM Part # Available	Polyflo Sleeve/Ferrule (1/4") - 25/pkg															
ADW038	No OEM Part # Available	Flat Washer - 50/pkg															
DSA002	60367	Duckbill Filter Assembly															
DSA008	63856	Hose Assembly & Filter (Air)															
DSA046	No OEM Part # Available	Water Supply Hose Assembly (Braided)															
DSA047	90125	Water Supply Line Assembly															
DSC017	No OEM Part # Available	Coil (Solenoid Valve)															
DSF005	90158	Disc Filter (Water) - 10/pkg															
DSF012	565162005	Foot Control															
DSF013	565138002, 565138003	Foot Control															
DSF039	77885	Foot Control															
DSF040	565162002	Foot Control															
DSF042	565162006	Foot Control															
DSF048	623072001	Union Connector (3/16" Push-In)															
DSH003	60388	Water Hose (Braided Blue)															
DSH009	80786	Air Hose (Braided Gray)															
DSK001	90172	Retrofit Water Filter Kit															
DSK016	No OEM Part # Available	Solenoid Valve Repair Kit															
DSK018	60367 (complete Assy.)	Repair Kit (Duckbill Filter Assembly)															
DSK020	No OEM Part # Available	Solenoid Valve Repair Kit															
DSK021	No OEM Part # Available	Water Filter Kit															
DSK022	81167	Check Valve Kit															
DSL024	No OEM Part # Available	Label (Air) - 3/pkg															
DSL025	No OEM Part # Available	Label (Water) - 3/pkg															
DSL026	No OEM Part # Available	Label (Caution) - 3/pkg															
DST014	574335001, 61350	Transistor															
DSV006	571070003	Solenoid Valve (Water)															
DSV011	629194002	Solenoid Valve (Pinch)															
DSV015	571070002	Solenoid Valve (Water)															
DSV019	81258	Solenoid Valve (Water)															
DSV023	629211001	Check Valve															
DSV027	629202001	Needle Valve (Water)															
RPA915	90088	Air Filter Assembly															
RPC557	554102003	Hospital Grade Power Cord (13A @ 125VAC, 8 ft.)															
RPC868	554102003	Hospital Grade Power Cord (13A @ 125VAC, 1.5 ft.)															
RPC869	554102003	Hospital Grade Power Cord (13A @ 125VAC, 3 ft.)															
RPE916	No OEM Part # Available	Filter Element															
RPF524	557034018	Fuse (1/8A, 250V) 5mm x 20mm Time Delay - 5/pkg															
RPF883	No OEM Part # Available	Polyflo Nut (1/4" Brass) - 5/pkg															
RPF907	621066001	Luer Lock (Male x 5/32" Barb) - 10/pkg															
RPF908	621065001	Luer Lock (Female x 5/32" Barb) - 10/pkg															
RPF913	No OEM Part # Available	Polyflo Fitting (1/4" Tube x 1/8" MPT) - 5/pkg															
RPF914	No OEM Part # Available	Adaptor (1/16" Barb x 1/8" MPT) - 5/pkg															
RPF917	No OEM Part # Available	Polyflo Fitting (1/4" Tube x #10-32 Male) - 5/pkg															
RPF918	79521	Quick Disconnect, Male (1/4" Poly Auto Shut-Off)															
RPF920	No OEM Part # Available	Quick Disconnect, Female (Panel Mount 1/4" Poly)															
RPF922	60537	Fuse (630MA, 250V) 5mm x 20mm Time Delay - 5/pkg															
RPF923	63827	Adaptor Elbow (1/16" Barb X 1/8" MPT) - 5/pkg															
RPF942	623064002	Cross Fitting (1/8" Barb x #10-32 Male) - 5/pkg															
RPF944	621068001	Adaptor Fitting (1/16" Barb x 1/8" Barb) - 10/pkg															
RPF948	No OEM Part # Available	Adaptor (1/16" Barb x 1/8" MPT) - 5/pkg															
RPF953	No OEM Part # Available	Polyflo Nut (1/4" Chrome) - 5/pkg															
RPF974	No OEM Part # Available	Luer Lock (Male x 1/8" Barb) - 10/pkg															
RPF975	621065001	Luer Lock (Female x 1/8" Barb) - 10/pkg															
RPF976	No OEM Part # Available	Male Connector (3/16" Push-In x #10-32 Male) - 2/pkg															
RPF977	6390253	Elbow Fitting (1/16" Barb x #10-32 Male) - 10/pkg															
RPF978	No OEM Part # Available	Swivel Elbow (1/8" Barb x #10-32 Male) - 2/pkg															
RPO304	No OEM Part # Available	O-Ring - 12/pkg															
RPO342	62351	O-Ring (Black) - 12/pkg															
RPO924	62605	O-Ring (Green) - 12/pkg															
RPS672	No OEM Part # Available	Cord Strap (White 6") - 3/pkg															
RPT296	No OEM Part # Available	Universal Sleeve Tool															
RPT909	No OEM Part # Available	Braided Tubing (1/4" OD Blue) - per ft.															
RPT910	No OEM Part # Available	Braided Tubing (1/4" OD Blue) (Box of 100 ft.)															
RPT911	No OEM Part # Available	Braided Tubing (1/4" OD Gray) - per ft.															
RPT912	No OEM Part # Available	Braided Tubing (1/4" OD Gray) (Box of 100 ft.)															
RPT927	No OEM Part # Available	Tubing (.160" ID x 1/4" OD Blue) - per ft.															
RPT940	61963	Tubing (1/16" ID x 1/8" OD Clear Polyurethane) - per ft.															
RPT941	625075001	Tubing (.107" ID x 3/16" OD Blue) - per ft.															
RPT973	625072001	Tubing (1/16" ID x 3/16" OD Black) - per ft.															
RPT999	No OEM Part # Available	Tubing (.160" ID x 1/4" OD Blue) (Box of 100 ft.)															
RXT001	625075001	Tubing (.107" ID x 3/16" OD Blue) (Box of 100 ft.)															
RXT008	712-00004	Cable Tie (.270" W x 8.75" Lg. White) - 25/pkg															
RXT016	61631	Pinch Tubing (1/16" ID x 1/8" OD Red) - per ft.															

Call Us Toll-Free Monday-Friday, 8:00 AM-4:30 PM (Pacific Time), (800) 221-9723

Dental Equipment

Cavitron® Models: BOBCAT® 25 KHz - G115, BOBCAT® Pro - G130, DualSelect™ Dispensing System - G118, JET Plus™ - G132, JET Plus™ - G137, JET with SPST™ - G120, Plus™ Scaler - G131, Plus™ Scaler - G136, Prophy-JET® Air Polishing System - G122, Prophy-Jet® - G138, Select™ Scaler 25K - G121, Select™ SPS™ 30K - G124, SPS™ Surface Mount Ultrasonic Scaler - G98a, SPS™ Ultrasonic Scaler - G119, & Touch™ Scaler - G1000

NOTES:

Lined area for notes, consisting of multiple horizontal lines.

SECTION

4

PAGE

1609

UPDATED

10/18

RPI Part #VPC069
OEM Part # See Chart Below



SOLIDS COLLECTOR (3/4")

- Ports: 3/4" FPT
- Material: Black plastic body with clear plastic bowl
- Includes: Bowl, Bowl Gasket (RPI Part #VPG080) and Screen (50 Mesh) (RPI Part #VPS076)

Fits: Manifold Assembly

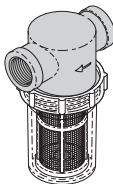

RPI Part #VPC070
OEM Part # See Chart Below



SOLIDS COLLECTOR (1")

- Ports: 1" FPT
- Material: Black plastic body with clear plastic bowl
- Includes: Bowl, Bowl Gasket (RPI Part #VPG081) and Screen (20 Mesh) (RPI Part #VPS079)

Fits: Manifold Assembly

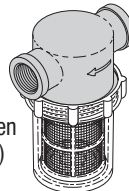

RPI Part #VPC071
OEM Part # See Chart Below



SOLIDS COLLECTOR (1-1/4")

- Ports: 1-1/4" FPT
- Material: Black plastic body with clear plastic bowl
- Includes: Bowl, Bowl Gasket (RPI Part #VPG081) and Screen (20 Mesh) (RPI Part #VPS079)

Fits: Manifold Assembly

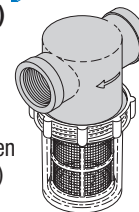

RPI Part #VPS076
OEM Part # See Chart Below



SCREEN (50 MESH)

- Material: Stainless steel screen; Blue plastic cage
- Size: 1.73" OD x 3.77" lg.

Fits: Solids Collector (3/4")

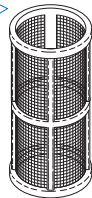

RPI Part #VPS077
OEM Part # See Chart Below



SCREEN (20 MESH)

- Material: Stainless steel screen; Red plastic cage
- Size: 1.73" OD x 3.77" lg.

Fits: Solids Collector (3/4")



RPI Part #VPG080
OEM Part # See Chart Below



BOWL GASKET

- 3 per package
- Material: Buna N (Nitrile)
- Size: 2.23" OD x .13" Square

Fits: Solids Collector Assembly (3/4")



RPI Part #VPS078
OEM Part # See Chart Below



SCREEN (50 MESH)

- Material: Stainless steel screen, Blue plastic cage
- Size: 2.47" OD x 4.25" lg.

Fits: Solids Collector (1") and (1-1/4")

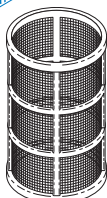

RPI Part #VPS079
OEM Part # See Chart Below



SCREEN (20 MESH)

- Material: Stainless steel screen; Red plastic cage
- Size: 2.47" OD x 4.25" lg.

Fits: Solids Collector (1") and (1-1/4")

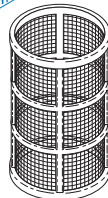

RPI Part #VPG081
OEM Part # See Chart Below



BOWL GASKET

- 3 per package
- Material: Buna N (Nitrile)
- Size: 3.13" OD x .13" Square

Fits: Solids Collector Assembly (1" & 1-1/4")



RPI Part #VPK072
OEM Part # See Chart Below



SOLIDS COLLECTOR REPLACEMENT KIT

- Includes all parts as shown
- Fits:** Solids Collector Assy. 3/4"

ALSO AVAILABLE BY THE CASE OF 12!



RPI Part #VPK074
OEM Part # See Chart Below



SOLIDS COLLECTOR REPLACEMENT KIT

- Includes all parts as shown
- Fits:** Solids Collector Assy. 1" and 1-1/4"

ALSO AVAILABLE BY THE CASE OF 8!

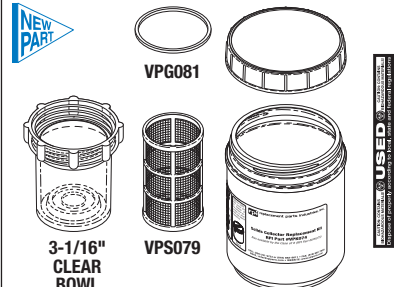

RPI Part #VPK073
OEM Part # See Chart Below

SOLIDS COLLECTOR REPLACEMENT KIT (CASE OF 12)

- Includes: (12) Solids Collector Replacement Kits (RPI Part #VPK072)

RPI Part #VPK075
OEM Part # See Chart Below

SOLIDS COLLECTOR REPLACEMENT KIT (CASE OF 8)

- Includes: (8) Solids Collector Replacement Kits (RPI Part #VPK074)

RPI PART #	DESCRIPTION	AIR TECHNIQUES	APOLLO/MIDMARK®	DENTALEZ®/CUSTOM AIR/RAMVAC	MATRIX/MIDMARK®	MIDMARK®	TECH WEST
VPC069	Solids Collector (3/4")	55862	PCC50705	64545040	62937301	62937301	VFA-40
VPC070	Solids Collector (1")		PCV50706	64501940		77005147	
VPC071	Solids Collector (1-1/4")	55612	PCV50708		77005155	77005155	
VPG080	Bowl Gasket - 3/pkg	55625		No OEM Part # Available	77007018	77007018	VFG-100
VPG081	Bowl Gasket - 3/pkg	No OEM Part # Available	MRP70936	No OEM Part # Available	77005158	77005158	
VPK072	Solids Collector Replacement Kit	55880	AVA60001	No OEM Part # Available	77005167	77005167	VFB-100
VPK073	Solids Collector Replacement Kit (Case of 12)	No OEM Part # Available	No OEM Part # Available	No OEM Part # Available	77005177	77005177	No OEM Part # Available
VPK074	Solids Collector Replacement Kit	55094	AVA600012	64568122	77005180	77005180	
VPK075	Solids Collector Replacement Kit (Case of 8)	No OEM Part # Available	No OEM Part # Available	No OEM Part # Available	77005181 & 77005178	77005181 & 77005178	
VPS076	Screen (50 Mesh)	No OEM Part # Available	No OEM Part # Available	No OEM Part # Available	No OEM Part # Available	No OEM Part # Available	No OEM Part # Available
VPS077	Screen (20 Mesh)	No OEM Part # Available	No OEM Part # Available	No OEM Part # Available	No OEM Part # Available	No OEM Part # Available	No OEM Part # Available
VPS078	Screen (50 Mesh)	No OEM Part # Available	No OEM Part # Available	No OEM Part # Available	No OEM Part # Available	No OEM Part # Available	
VPS079	Screen (20 Mesh)	No OEM Part # Available	No OEM Part # Available	No OEM Part # Available	77005079	77005079	

Call Us Toll-Free Monday-Friday, 8:00 AM-4:30 PM (Pacific Time), (800) 221-9723

Dental Equipment

Air Techniques, Apollo/Midmark®, DentalEZ®/Custom Air/RamVac, Matrix/Midmark®, Midmark® & Tech West

DENTAL VACUUM UNITS - Air Techniques, Apollo/Midmark®, DentalEZ®/Custom Air/RamVac, Matrix/Midmark®, Midmark® & Tech West

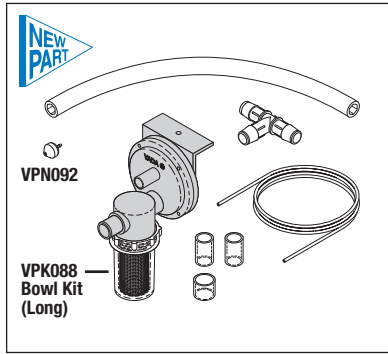

RPI Part #VPV083
OEM Part #4512266

CUSPIDOR DRAIN VALVE (VADA TRAP)

- Automatic drain for dental cuspidor
- Connects to central vacuum system and eliminates conventional plumbing drain
- Allows installation where a gravity drain is not available or practical
- Includes all parts as shown
- Included in: Sink Drain Valve Assembly (RPI Part #VPK082)

Fits: Dental Cuspidors
Models: All Vada Traps

Note: Adapts all OEM dental delivery cuspidors to a central vacuum line when there is not a normal gravity drain available.

RPI Part #VPN092

OEM Part #

(No OEM Part # Available)

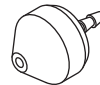

CLEAN OUT-NIPPLE

- Material: Black plastic tip with 1/16" barb
- Fits:** Vada Trap
Models: All Vada Traps

RPI Part #VPK088

OEM Part #

(No OEM Part # Available)



BOWL KIT (LONG)

- Includes all parts as shown
 - Bowl Height: 2.67" tall
- Fits:** Sink and Cuspidor Drain Valve Assemblies (Vada Trap) Serial Number 00001 and After
Models: All Vada Traps

RPI Part #VPK087

OEM Part #

(No OEM Part # Available)

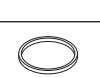

BOWL KIT (SHORT)

- Includes all parts as shown
 - Bowl Height: 1.34" tall
- Fits:** Sink and Cuspidor Drain Valve Assemblies Manufactured Before September 1997 and All Units Without Serial Numbers
Models: All Vada Traps

RPI Part #VPG091

OEM Part #

(No OEM Part # Available)



BOWL GASKET

- 3 per package
 - Material: Silicone rubber
 - Size: 1.43" OD x 1.28" ID x .11" thk
- Fits:** Sink and Cuspidor Drain Valve Assembly
Models: All Vada Traps

RPI Part #VPS090

OEM Part #

(No OEM Part # Available)



SCREEN (LONG)

- Size: 1" dia. x 2.62" lg.
 - Material: 20 Mesh stainless steel
- Fits:** Sink and Cuspidor Drain Valve Assemblies (Vada Trap) Serial #00001 and After
Models: All Vada Traps

RPI Part #VPS089

OEM Part #

(No OEM Part # Available)



SCREEN (SHORT)

- Size: 1" dia. x 1.34" lg.
 - Material: 20 Mesh stainless steel
- Fits:** Sink and Cuspidor Drain Valve Assemblies (Vada Trap) Manufactured Before September 1997 and All Units Without Serial Numbers
Models: All Vada Traps

RPI Part #VPA084

OEM Part # (No OEM Part # Available)

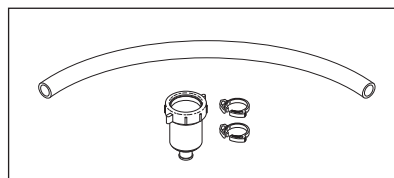

SINK ADAPTOR

- Connects to 1-1/2" sink drain tailpiece and reduces to 5/8" tubing connector to connect to vacuum system
- Includes all parts as shown
- Included in: Sink Drain Valve Assembly (RPI Part #VPK082)

Fits: Standard or Operator Sinks

Models: All Vada Traps

RPI Part #VPK082

OEM Part #45R062

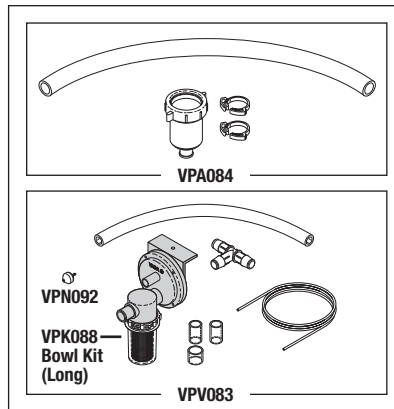

SINK DRAIN VALVE ASSEMBLY

- Automatic drain for standard or operator sink 1-1/2" tailpiece
- Connects to central vacuum system and eliminates conventional plumbing drain
- Allows installation where a gravity drain is not available or practical
- Includes: Sink Adapter (RPI Part #VPA084) and Cuspidor Drain Valve (RPI Part #VPV083)
- Also available: Diaphragm (RPI Part #VPD086) and Bowl Kit (Long) (RPI Part #VPK088)

Fits: Standard or Operator Sinks

Models: All Vada Traps

Note: Adapts all OEM sinks to a central vacuum line when there is not a normal gravity drain available.

RPI Part #VPD085

OEM Part #

(No OEM Part # Available)

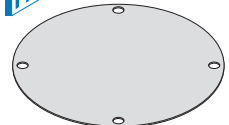

DIAPHRAGM

- Material: Silicone rubber
 - Size: 3" dia. with four mounting holes
- Fits:** Sink and Cuspidor Drain Valve Assemblies (Vada Trap) and Units Without Serial Numbers
Models: All Vada Traps

RPI Part #VPD086

OEM Part #

(No OEM Part # Available)

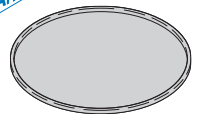

DIAPHRAGM

- Material: Silicone rubber
- Size: 2-9/16" dia. without mounting holes
- Also available: Sink Drain Valve Assembly (RPI Part #VPK082) and Cuspidor Drain Valve (RPI Part #VPV083)

Fits: Sink and Cuspidor Drain Valve Assemblies (Vada Trap) Serial Number 0001 and above (Including All Vada Traps Sold By RPI)
Models: All Vada Traps

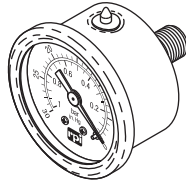

RPI Part #GOG046
OEM Part # See Chart Below

VACUUM GAUGE

- Size: 1-1/2" dia.
- Dual Scale: 0 to 30 In. Hg (0 to 1 Bar)
- Material: Stainless steel case and bezel
- Port: 1/8" MPT center back mount
- Fits:** Manifold Assembly



Liquid Filled!

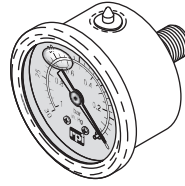

RPI Part #VPG044
OEM Part # See Chart Below

VACUUM GAUGE (LIQUID FILLED)

- Size: 1-1/2" dia.
- Dual Scale: 0 to 30 In. Hg (0 to 1 Bar)
- Material: Stainless steel case and bezel
- Port: 1/8" MPT center back mount
- Fits:** Manifold Assembly

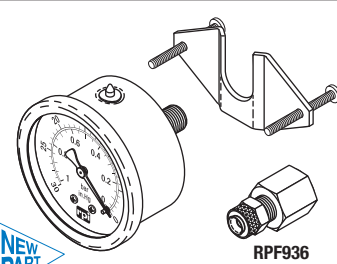

RPI Part #VPG094
OEM Part # See Chart Below

VACUUM GAUGE

- Size: 2.0" dia.
- Dual Scale: 0 to 30 In. Hg (0 to 1 Bar)
- Material: Stainless steel case and bezel
- Port: 1/4" MPT center back mount
- Includes all parts as shown
- Fits:** Manifold Assembly

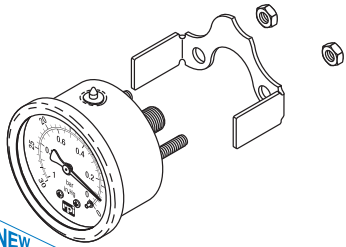

RPI Part #VPG045
OEM Part # See Chart Below

VACUUM GAUGE

- Size: 2.0" dia.
- Dual Scale: 0 to 30 In. Hg (0 to 1 Bar)
- Material: Stainless steel case and bezel
- Port: 1/8" MPT center back mount
- Includes all parts as shown
- Fits:** Manifold Assembly



Liquid Filled!

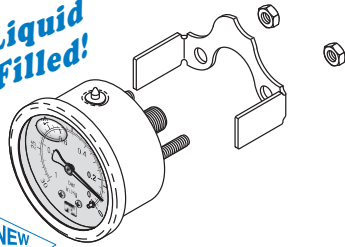

RPI Part #VPG046
OEM Part # See Chart Below

VACUUM GAUGE (LIQUID FILLED)

- Size: 2.0" dia.
- Dual Scale: 0 to 30 In. Hg (0 to 1 Bar)
- Material: Stainless steel case and bezel
- Port: 1/8" MPT center back mount
- Includes all parts as shown
- Fits:** Manifold Assembly

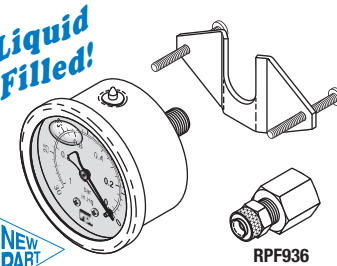

RPI Part #VPG095
OEM Part # See Chart Below

VACUUM GAUGE (LIQUID FILLED)

- Size: 2.0" dia.
- Dual Scale: 0 to 30 In. Hg (0 to 1 Bar)
- Material: Stainless steel case and bezel
- Port: 1/4" MPT center back mount
- Includes all parts as shown
- Fits:** Manifold Assembly

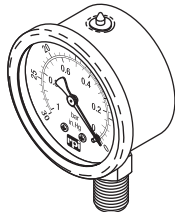

RPI Part #VPG047
OEM Part # See Chart Below

VACUUM GAUGE

- Size: 2.0" dia.
- Dual Scale: 0 to 30 In. Hg (0 to 1 Bar)
- Material: Stainless steel case and bezel
- Ports: 1/4" MPT bottom mount
- Fits:** Manifold Assembly



Liquid Filled!

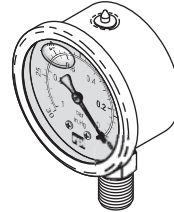

RPI Part #VPG048
OEM Part # See Chart Below

VACUUM GAUGE (LIQUID FILLED)

- Size: 2.0" dia.
- Dual Scale: 0 to 30 In. Hg (0 to 1 Bar)
- Material: Stainless steel case and bezel
- Port: 1/4" MPT bottom mount
- Fits:** Manifold Assembly



RPI Part #RPF936
OEM Part # See Chart Below

FEMALE CONNECTOR (1/4" POLY x 1/4" FPT)

- 2 per package
- Size: 1/4" Polyflo x 1/4" FPT
- Material: Brass
- Includes: Brass polyflo sleeve
- Fits:** Vacuum Gauge

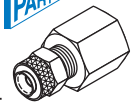

RPI PART #	DESCRIPTION	AIR TECHNIQUES	APOLLO/MIDMARK®	DENTALEZ®/CUSTOM AIR/RAMVAC	MATR/MIDMARK®	MIDMARK®	TECH WEST
GOG046	Vacuum Gauge	55616			62947800	62947800	
VPG044	Vacuum Gauge (Liquid Filled)	55616			62947800	62947800	
VPG045	Vacuum Gauge	55680					
VPG046	Vacuum Gauge (Liquid Filled)	55680					
VPG047	Vacuum Gauge		014-0550-00	64568188			VPG-100
VPG048	Vacuum Gauge (Liquid Filled)		014-0550-00	64568188			VPG-100
VPG094	Vacuum Gauge			64568134			
VPG095	Vacuum Gauge (Liquid Filled)			64568134			
RPF936	Female Connector (1/4" Poly x 1/4" FPT) - 2/pkg			No OEM Part # Available			

Call Us Toll-Free Monday-Friday, 8:00 AM-4:30 PM (Pacific Time), (800) 221-9723

Dental Equipment

Air Techniques, Apollo/Midmark®, DentalEZ®/Custom Air/RamVac, Matrix/Midmark®, Midmark® & Tech West

Air Techniques, Apollo/Midmark®, DentalEZ®/Custom Air/RamVac, Matrix/Midmark®, Midmark® & Tech West

DENTAL VACUUM UNITS -

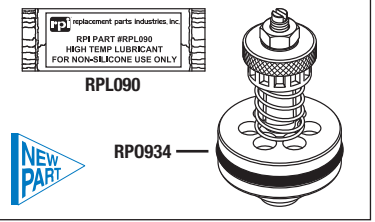

RPI Part #VPV059
OEM Part # See Chart Below

VACUUM RELIEF VALVE
 • Includes all parts as shown
 • Also available: Filter Element and Screen (RPI Part #VPE064)
Fits: Manifold Assembly



RPI Part #RPO934
OEM Part # See Chart Below
Industry Part #AS578-220

O-RING
 • 3 per package
 • Size: 1.359" ID x 1.637" OD x .139" C/S
 • Material: Buna-N (Nitrile), 70 Duro
Fits: Vacuum Relief Valve

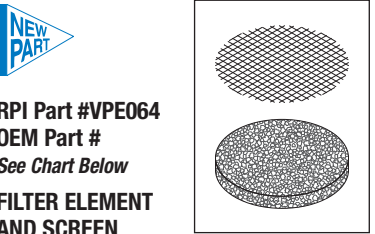

RPI Part #VPE064
OEM Part # See Chart Below
FILTER ELEMENT AND SCREEN
 • Size: 1.88" OD x .25" thk. foam filter
 • Includes: PM sticker
Fits: Vacuum Relief Valve Assembly



RPI Part #VPE065
OEM Part # See Chart Below
FILTER ELEMENT
 • Size: 2.00" OD x 1.00" lg. foam filter
 • Includes: PM sticker
Fits: Vacuum Relief Valve Assembly

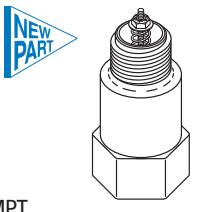

RPI Part #VPV063
OEM Part # See Chart Below
VACUUM RELIEF VALVE (3/4")
 • 3/4" FPT x 3/4" MPT
 • Material: Grey PVC body; EPDM seal
 • Preset @ approx. 5 lb (adjustable)
 • Adjusting nut 1-1/2 turn = 1 lb. force
 • Also available: Filter Element (RPI Part #VPE068)
Fits: Manifold Assembly

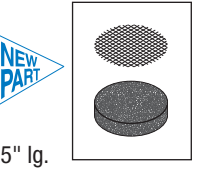

RPI Part #VPE068
OEM Part # See Chart Below
FILTER ELEMENT AND SCREEN
 • Size: .88" OD x .25" lg.
 • Includes: PM sticker
Fits: Vacuum Relief Valve Assembly

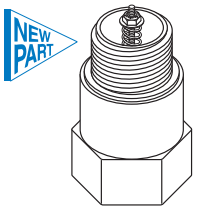

RPI Part #VPV060
OEM Part # See Chart Below
VACUUM RELIEF VALVE (1")
 • 1" FPT x 1" MPT
 • Material: White PVC body; EPDM seal
 • Preset @ approx. 5 lb (adjustable)
 • Adjusting nut 1-1/2 turn = 1 lb. force
 • Also available: Foam Element (RPI Part #CMF013)
Fits: Manifold Assembly

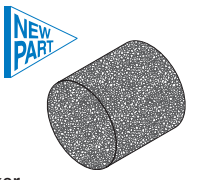

RPI Part #CMF013
OEM Part # See Chart Below
FILTER ELEMENT
 • Size: 2.00" OD x 2.00" lg. foam filter
 • Includes: PM sticker
Fits: Vacuum Relief Valve Assembly

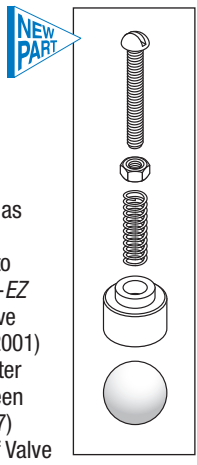

RPI Part #VPK062
OEM Part # See Chart Below
VACUUM RELIEF VALVE REPAIR KIT
 • Includes all parts as shown
 • Allows customer to rebuild the Dental-EZ Vacuum Relief Valve (OEM Part #64622001)
 • Also available: Filter Element and Screen (RPI Part #VPE067)
Fits: Vacuum Relief Valve

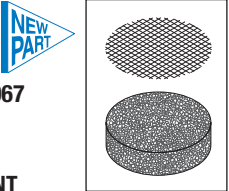

RPI Part #VPE067
OEM Part # See Chart Below
FILTER ELEMENT AND SCREEN
 • Size: 1.65" OD x .50" lg. foam filter
 • Includes: PM sticker
 • Also available: Vacuum Relief Valve Repair Kit (RPI Part #VPK062) and Filter Assembly (RPI Part #VPF066)
Fits: Filter Assembly

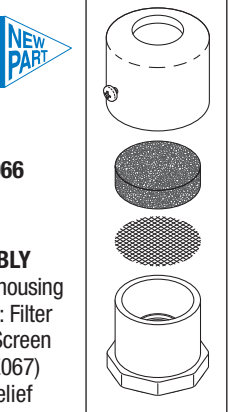

RPI Part #VPF066
OEM Part # See Chart Below
FILTER ASSEMBLY
 • Material: PVC housing
 • Also available: Filter Element and Screen (RPI Part #VPE067)
Fits: Vacuum Relief Valve

RPI PART #	DESCRIPTION	AIR TECHNIQUES	APOLLO/MIDMARK®	DENTALEZ®/CUSTOM AIR/RAMVAC	MATRIX/MIDMARK®	MIDMARK®	TECH WEST
CMF013	Filter Element		20207400 & 202047500				
RP0934	O-ring - 3/pkg	No OEM Part # Available					
VPE064	Filter Element and Screen	55713					
VPE065	Filter Element				62935604	62935604	
VPE067	Filter Element and Screen			64568145			
VPE068	Filter Element and Screen						No OEM Part # Available
VPF066	Filter Assembly			64568159			
VPK062	Vacuum Relief Valve Repair Kit			No OEM Part # Available			
VPV059	Vacuum Relief Valve	55865					
VPV060	Vacuum Relief Valve (1")		PVW85980 & PW85981				
VPV063	Vacuum Relief Valve (3/4")						VRV-100

RPI Part #VPV057

OEM Part # See Chart Below

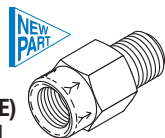

CHECK VALVE (1/4" IN-LINE)

- Cracking Pressure: 1.0 PSI
 - Ports: 1/4" FPT Inlet x 1/4" MPT Outlet
 - Material: Brass body, Buna-N (Nitrile) seal
- Fits:** Manifold Assembly

RPI Part #VPV058

OEM Part #

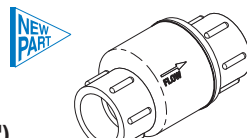

CHECK VALVE (3/4")

- Ports: 3/4" Slip x 3/4" Slip Schedule 40
 - Material: White PVC plastic
- Fits:** Manifold Assembly



RPI Part #VPG039

OEM Part # See Chart Below

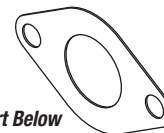

MANIFOLD GASKET

Fits: Manifold Assembly

RPI Part #VPV055

OEM Part #

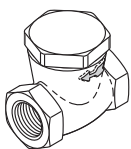

See Chart Below

CHECK VALVE (3/8")

- Ports: 3/8" FPT
 - Material: Bronze body
 - The RPI Check Valve is a rebuildable valve with a Buna-N (Nitrile) seal - It's the RPI Advantage!
 - Also available: Check Valve Repair Kit (RPI Part #VPK050)
- Fits:** Manifold Assembly

RPI Part #VPV051

OEM Part #

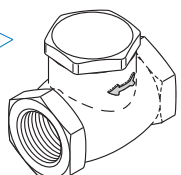

See Chart Below

CHECK VALVE (3/4")

- Ports: 3/4" FPT
 - Material: Bronze body
 - The RPI Check Valve is a rebuildable valve with a Buna-N (Nitrile) seal - It's the RPI Advantage!
 - Also available: Check Valve Repair Kit (RPI Part #VPK052)
- Fits:** Manifold Assembly



RPI Part #VPG040

OEM Part # See Chart Below

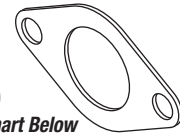

MANIFOLD GASKET

Fits: Manifold Assembly

RPI Part #VPV049

OEM Part #

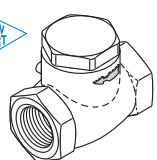

See Chart Below

CHECK VALVE (1/2")

- Ports: 1/2" FPT
 - Material: Bronze body
 - The RPI Check Valve is a rebuildable valve with a Buna-N (Nitrile) seal - It's the RPI Advantage!
 - Also available: Check Valve Repair Kit (RPI Part #VPK050)
- Fits:** Manifold Assembly

RPI Part #VPK052

OEM Part # See Chart Below

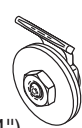

CHECK VALVE REPAIR KIT (3/4")

- Material: Buna-N (Nitrile) seat
- Fits: Only Fits** RPI's Check Valve (3/4") (RPI Part #VPV051)



RPI Part #VPG041

OEM Part # See Chart Below

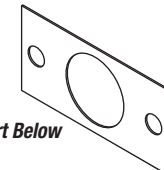

MANIFOLD GASKET

Fits: Manifold Assembly

RPI Part #VPK050

OEM Part # See Chart Below



CHECK VALVE REPAIR KIT (1/2" & 3/8")

- Material: Buna-N (Nitrile) seal
- Fits: Only Fits** Check Valve (1/2") (RPI Part #VPV049) and Check Valve (3/8") (RPI Part #VPV055)

RPI Part #VPV053

OEM Part #

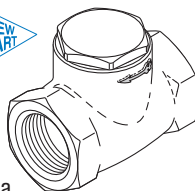

See Chart Below

CHECK VALVE (1")

- Ports: 1" FPT
 - Material: Bronze body
 - The RPI Check Valve is a rebuildable valve with a Buna-N (Nitrile) seal - It's the RPI Advantage!
 - Also available: Check Valve Repair Kit (RPI Part #VPK054)
- Fits:** Manifold Assembly



RPI Part #VPG042

OEM Part # See Chart Below

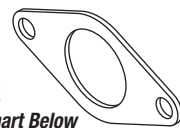

MANIFOLD GASKET

Fits: Manifold Assembly

RPI Part #VPK054

OEM Part # See Chart Below



CHECK VALVE REPAIR KIT (1")

- Material: Buna-N (Nitrile) seat
- Fits: Only Fits** RPI's Check Valve (1") (RPI Part #VPV053)



RPI Part #VPG043

OEM Part # See Chart Below

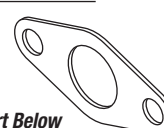

MANIFOLD GASKET

Fits: Manifold Assembly

RPI PART #	DESCRIPTION	AIR TECHNIQUES	APOLLO/MIDMARK®	DENTAL EZ®/CUSTOM AIR/RAMVAC	MATRX/MIDMARK®	MIDMARK®	TECH WEST
VPG039	Manifold Gasket	55617					
VPG040	Manifold Gasket				61203200	61203200	
VPG041	Manifold Gasket		MMS71167				
VPG042	Manifold Gasket			64568137			
VPG043	Manifold Gasket						MG-100
VPG093	Manifold Gasket		MMS71165				
VPK050	Check Valve Repair Kit (1/2" & 3/8")		No OEM Part # Available	No OEM Part # Available			
VPK052	Check Valve Repair Kit (3/4")	No OEM Part # Available	No OEM Part # Available	No OEM Part # Available	No OEM Part # Available	No OEM Part # Available	
VPK054	Check Valve Repair Kit (1")		No OEM Part # Available	No OEM Part # Available			
VPV049	Check Valve (1/2")		PW50656				
VPV051	Check Valve (3/4")	56105	PW50657	64568191	770002003	770002003	
VPV053	Check Valve (1")		PW50658	64568193			
VPV055	Check Valve (3/8")			64622311			
VPV057	Check Valve (1/4" In-Line)	56056					
VPV058	Check Valve (3/4")						CVF-750

Call Us Toll-Free Monday-Friday, 8:00 AM-4:30 PM (Pacific Time), (800) 221-9723

Dental Equipment

Air Techniques, Apollo/Midmark®, DentalEZ®/Custom Air/RamVac, Matrix/Midmark®, Midmark® & Tech West

RPI Part #VPA001
OEM Part #64568196



WATER CONTROL ASSEMBLY (1 HP)

- Fully assembled for easy installation
- 0.5 GPM flow
- 24VAC solenoid valve
- Includes all parts as shown

Fits: 1 HP Wet Ring Vacuum System

Models: DentalEZ/Custom Air/
RamVac: CV-101 FS

See our website
www.rpiparts.com
for an Exploded View of
the Water Control Assembly!

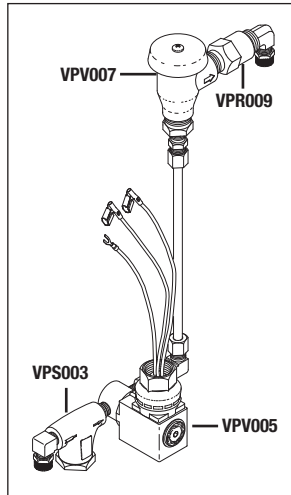

RPI Part #VPA002
OEM Part #64568197



WATER CONTROL ASSEMBLY (2 HP)

- Fully assembled for easy installation
- 1.0 GPM flow
- 24VAC solenoid valve
- Includes all parts as shown

Fits: 2 HP Wet Ring Vacuum Systems

Models: DentalEZ/Custom Air/
RamVac: CV-102 FS

See our website
www.rpiparts.com
for an Exploded View of
the Water Control Assembly!

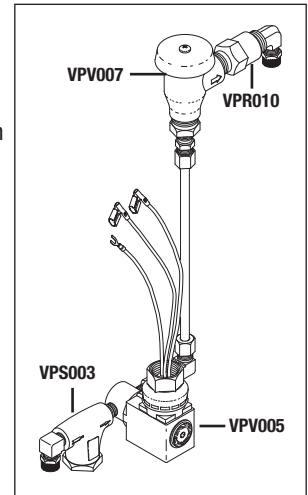

With RPI, now you have a choice to replace the Strainer or just the Strainer Element – It's the RPI Advantage!

RPI Part #VPS003
OEM Part # See Chart Below

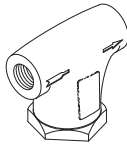

STRAINER (WATER-1/8")

- Material: Lead free cast copper silicon alloy
- Ports: 1/8" FPT
- Also available: Strainer Element (RPI Part #VPE004)
- Included in: Water Control Assembly (RPI Part #VPA001 & VPA002)

Fits: Water Control Assembly

STRAINER ELEMENT

RPI Part #VPE004
OEM Part # See Chart Below



STRAINER ELEMENT

- Material: 40 mesh stainless steel
- Includes all parts as shown
- Also available: Strainer (Water-1/8") (RPI Part #VPS003)

Fits: Water Control Assembly



SEALING WASHER

RPI Part #VPS011
OEM Part # See Chart Below

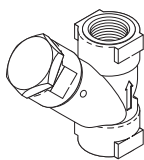

STRAINER (WATER-1/4")

- Material: Plastic
- Ports: 1/4" FPT
- Also available: Strainer Element (RPI Part #VPE012)

Fits: Water Control Assembly

STRAINER ELEMENT

RPI Part #VPE012
OEM Part # See Chart Below



STRAINER ELEMENT

- Material: 100 mesh stainless steel
- Includes all parts as shown
- Also available: Strainer (Water-1/4") (RPI Part #VPS011)

Fits: Water Control Assembly



RP0318

RPI Part #VPS013
OEM Part # See Chart Below

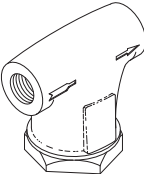

STRAINER (WATER-1/4")

- Material: Lead free cast copper silicon alloy
- Ports: 1/4" FPT
- Also available: Strainer Element (RPI Part #VPE014)

Fits: Water Control Assembly

STRAINER ELEMENT

RPI Part #VPE014
OEM Part # See Chart Below



STRAINER ELEMENT

- Material: 60 mesh stainless steel
- Includes all parts as shown
- Also available: Strainer (Water-1/4") (RPI Part #VPS013)

Fits: Water Control Assembly



RP0325

RPI PART #	DESCRIPTION	AIR TECHNIQUES	APOLLO/MIDMARK®	DENTALEZ®/CUSTOM AIR/RAMVAC	MATRIX/MIDMARK®	MIDMARK®	TECH WEST
VPE004	Strainer Element	No OEM Part # Available		No OEM Part # Available			No OEM Part # Available
VPE012	Strainer Element					No OEM Part # Available	
VPE014	Strainer Element	No OEM Part # Available	No OEM Part # Available		No OEM Part # Available		
VPS003	Strainer (Water-1/8")	55526		64568135 (includes fittings)			No OEM Part # Available
VPS011	Strainer (Water-1/4")					65962000	
VPS013	Strainer (Water-1/4")	55909	PCB50960		77005145		

FAX: (818) 882-7028 • E-MAIL: order@rpiparts.com • WEBSITE: www.rpiparts.com

Air Techniques, Apollo/Midmark®, DentalEZ®/Custom Air/RamVac, Matrix/Midmark®, Midmark® & Tech West

DENTAL VACUUM UNITS -

SECTION

4

PAGE
1705

UPDATED
09/15

With RPI, now you have a choice to replace the Solenoid Valve or repair it with one of our exclusive Kits – It's the RPI Advantage!

RPI Part #VPV005

OEM Part # See Chart Below

SOLENOID VALVE ASSEMBLY

- Ports: 1/8" FPT; 2-way; N.O.
- 24VAC, 60Hz., 8.5W; 18" lg. wires
- Material: Stainless steel body; Viton seals
- Includes all parts as shown
- Included in: Water Control Assembly (RPI Part #'s VPA001 & VPA002)

Fits: Water Control Assembly

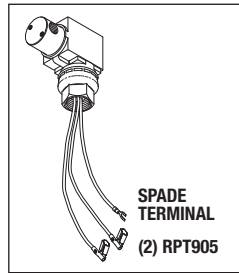

REPAIR KIT

RPI Part #VPK006

OEM Part # See Chart Below

SOLENOID VALVE REPAIR KIT

- Includes all parts as shown
- Also available: Solenoid Valve Assembly (RPI Part #'s VPV005, VPV015 & VPV038)

Fits: Solenoid Valve Assembly

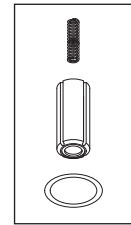

RPI Part #VPV015

OEM Part # See Chart Below

SOLENOID VALVE ASSEMBLY

- Ports: 1/8" FPT; 2-way; N.C.
- 120VAC, 60Hz., 8.5W; 1/4" Tabs
- Material: Stainless steel body; Viton seals

Fits: Water Control Assembly

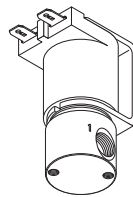

REPAIR KIT

RPI Part #VPK006

OEM Part # See Chart Below

SOLENOID VALVE REPAIR KIT

- Includes all parts as shown
- Also available: Solenoid Valve Assembly (RPI Part #'s VPV005, VPV015 & VPV038)

Fits: Solenoid Valve Assembly

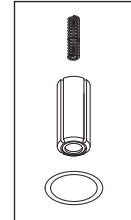

RPI Part #VPV038

OEM Part # See Chart Below

SOLENOID VALVE ASSEMBLY

- Ports: 1/8" FPT; 2-way; N.C.
- 220VAC, 50Hz., 8.5W; 1/4" Tabs
- Material: Stainless steel body; Viton seals

Fits: Water Control Assembly

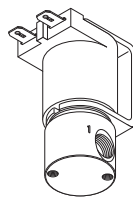

REPAIR KIT

RPI Part #VPK006

OEM Part # See Chart Below

SOLENOID VALVE REPAIR KIT

- Includes all parts as shown
- Also available: Solenoid Valve Assembly (RPI Part #'s VPV005, VPV015 & VPV038)

Fits: Solenoid Valve Assembly

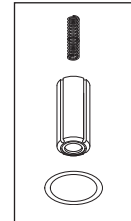

RPI Part #VPV017

OEM Part # See Chart Below

SOLENOID VALVE ASSEMBLY

- Ports: 1/8" FPT; 2-way; N.C.
- 120VAC, 60Hz., 7W; 12" lg. wires
- Material: Stainless steel body; Nitrile (Buna-N) seals
- Includes all parts as shown

Fits: Water Control Assembly

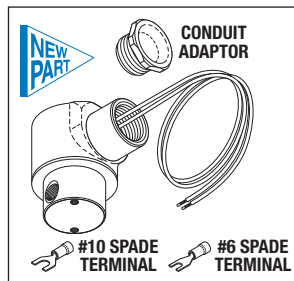

REPAIR KIT

RPI Part #VPK018

OEM Part # See Chart Below

SOLENOID VALVE REPAIR KIT

- Includes all parts as shown
- Also available: Solenoid Valve Assembly (RPI Part #'s VPV017 & VPV036)

Fits: Water Control Solenoid Valve

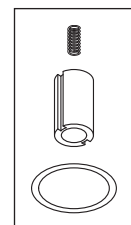

Note: When replacing the Solenoid Valve (RPI Part #VPV017) in units that require the Upgrade Kit (OEM Part #55020), see our website www.rpiparts.com for additional fittings and hardware parts available.

RPI Part #VPV036

OEM Part # See Chart Below

SOLENOID VALVE ASSEMBLY

- Ports: 1/8" FPT; 2-way; N.C.
- 240VAC, 60Hz., 7W; 12" lg. wires
- Material: Stainless steel body; Nitrile (Buna-N) seals
- Includes all parts as shown

Fits: Water Control Assembly

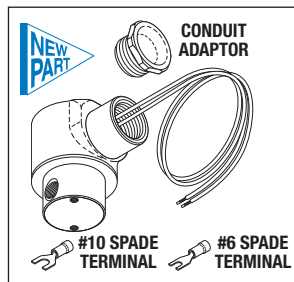

REPAIR KIT

RPI Part #VPK018

OEM Part # See Chart Below

SOLENOID VALVE REPAIR KIT

- Includes all parts as shown
- Also available: Solenoid Valve Assembly (RPI Part #'s VPV017 & VPV036)

Fits: Water Control Solenoid Valve

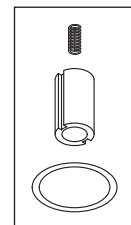

RPI PART #	DESCRIPTION	AIR TECHNIQUES	APOLLO/MIDMARK®	DENTALEZ®/CUSTOM AIR/RAMVAC	MATR X/MIDMARK®	MIDMARK®
VPK006	Solenoid Valve Repair Kit		No OEM Part # Available	No OEM Part # Available	No OEM Part # Available	No OEM Part # Available
VPK018	Solenoid Valve Repair Kit	No OEM Part # Available				
VPV005	Solenoid Valve Assembly			64568156		
VPV015	Solenoid Valve Assembly		PW10470		77005146 & 77001620	77005146 & 77001620
VPV017	Solenoid Valve Assembly	55387				
VPV036	Solenoid Valve Assembly	55040, 55060, 55080, 55107 & 55116				
VPV038	Solenoid Valve Assembly		PW10472			77001621

Call Us Toll-Free Monday–Friday, 8:00 AM–4:30 PM (Pacific Time), (800) 221-9723

Dental Equipment

Air Techniques, Apollo/Midmark®, DentalEZ®/Custom Air/RamVac, Matrix/Midmark®, Midmark® & Tech West

With RPI, now you have a choice to replace the Solenoid Valve or repair it with one of our exclusive Kits – It's the RPI Advantage!

RPI Part #VPV019

OEM Part # See Chart Below



SOLENOID VALVE ASSEMBLY

- Ports: 1/8" FPT; 2-way; N.C.
 - 120VAC, 60Hz., 6.3W; 18" lg. wires
 - Material: Stainless steel body; Viton seals
 - Includes all parts as shown
- Fits:** Water Control Assembly

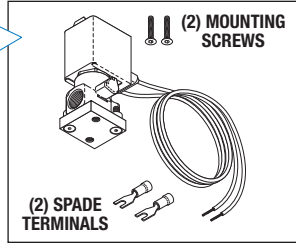

RPI Part #VPK020

OEM Part # See Chart Below



SOLENOID VALVE REPAIR KIT

- Includes all parts as shown
 - Also available: Solenoid Valve Assembly (RPI Part #'s VPV019 & VPV037)
- Fits:** Solenoid Valve Assembly

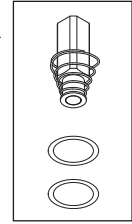

RPI Part #VPV037

OEM Part # See Chart Below



SOLENOID VALVE ASSEMBLY

- Ports: 1/8" FPT; 2-way; N.C.
 - 220VAC, 60HZ., 6.3W; 18" lg. wires
 - Material: Stainless steel body; Viton seals
 - Includes all parts as shown
- Fits:** Water Control Assembly

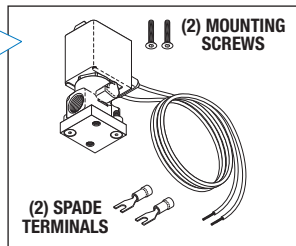

RPI Part #VPK020

OEM Part # See Chart Below



SOLENOID VALVE REPAIR KIT

- Includes all parts as shown
 - Also available: Solenoid Valve Assembly (RPI Part #'s VPV019 & VPV037)
- Fits:** Solenoid Valve Assembly

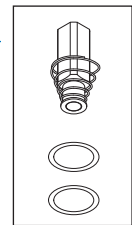

RPI Part #VPV034

OEM Part # See Chart Below



SOLENOID VALVE ASSEMBLY

- Ports: 1/8" FPT; 2-way; N.C.
 - 120VAC; 60Hz., 8W; 24" lg. wires
 - Material: Stainless steel body; Nitrile (Buna-N) seals
 - Includes all parts as shown
- Fits:** Water Control Assembly

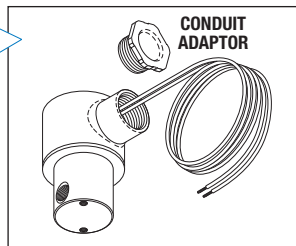

RPI Part #VPK035

OEM Part # See Chart Below



SOLENOID VALVE REPAIR KIT

- Includes all parts as shown
 - Also available: Solenoid Valve Assembly (RPI Part #VPV034)
- Fits:** Solenoid Valve Assembly

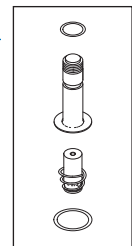

RPI PART #	DESCRIPTION	AIR TECHNIQUES	APOLLO/MIDMARK®	DENTALEZ®/CUSTOM AIR/RAMVAC	MATRIX/MIDMARK®	MIDMARK®	TECH WEST
VPK020	Solenoid Valve Repair Kit	No OEM Part # Available					
VPK035	Solenoid Valve Repair Kit						No OEM Part # Available
VPV019	Solenoid Valve Assembly	55519					
VPV034	Solenoid Valve Assembly						PSV-115
VPV037	Solenoid Valve Assembly	55518					

With RPI, now you have a choice to replace the Anti-Syphon Valve or repair it with one of our Kits – It's the RPI Advantage!

APOLLO BRAND

RPI Part #VPV021

OEM Part # See Chart Below



ANTI-SYPHON VALVE (1/4")

- Material: Brass; Silicone seal
 - Ports: 1/4" FPT
- Fits:** Water Control Assembly

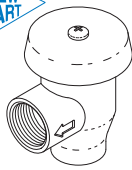

APOLLO BRAND

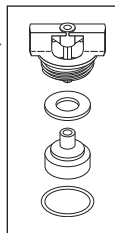

RPI Part #VPK008

OEM Part # See Chart Below

ANTI-SYPHON VALVE REPAIR KIT

- Includes all parts as shown
 - Material: Silicone seal
 - Used to repair the **Apollo** brand Anti-Syphon Valve (1/4" & 3/8") **Only**
 - For Watts brand Anti-Syphon Valve Repair Kit, use RPI Part #VPK016
- Fits:** Apollo Anti-Syphon Valves (RPI Part #'s VPV007 and VPV021)

WATTS BRAND

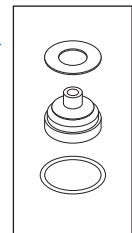

RPI Part #VPK016

OEM Part # See Chart Below

ANTI-SYPHON VALVE REPAIR KIT

- Includes all parts as shown
 - Material: Silicone seal
 - Used to repair the **Watts** brand Anti-Syphon Valve (1/4" & 3/8") **Only**
 - For Apollo brand Anti-Syphon Valve Repair Kit, use RPI Part #VPK008
- Fits:** Watts 1/4" and 3/8" Anti-Syphon Valves

APOLLO BRAND

RPI Part #VPV007

OEM Part # See Chart Below



ANTI-SYPHON VALVE (3/8")

- Material: Brass; Silicone seal
 - Ports: 3/8" FPT
 - Included in: Water Control Assembly (RPI Part #'s VPA001 & VPA002)
- Fits:** Water Control Assembly

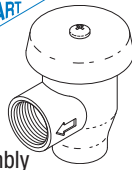

RPI PART #	DESCRIPTION	AIR TECHNIQUES	APOLLO/MIDMARK®	DENTALEZ®/CUSTOM AIR/RAMVAC	MATRIX/MIDMARK®	MIDMARK®	TECH WEST
VPK008	Anti-Syphon Valve Repair Kit	55517	No OEM Part # Available	64568016A	77005073	77005073	No OEM Part # Available
VPK016	Anti-Syphon Valve Repair Kit	55517	No OEM Part # Available	64568016A	77005073	77005073	No OEM Part # Available
VPV007	Anti-Syphon Valve (3/8")	55525		64622011			
VPV021	Anti-Syphon Valve (1/4")		PW50595		77005072	77005072	PVB100

FAX: (818) 882-7028 • E-MAIL: order@rpiparts.com • WEBSITE: www.rpiparts.com

Air Techniques, Apollo/Midmark®, DentalEZ®/Custom Air/RamVac, Matrix/Midmark®, Midmark® & Tech West

DENTAL VACUUM UNITS -

SECTION 4

PAGE 1707

UPDATED 09/15

RPI Part #VPR009
OEM Part # See Chart Below

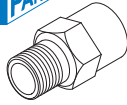

FLOW REGULATOR (0.5 GPM)

- Material: Nickel plated brass
- Ports: 3/8" FPT x 3/8" MPT
- Included in: Water Control Assembly (1 HP) (RPI Part #VPA001)

Fits: Water Control Assembly

RPI Part #VPR010
OEM Part # See Chart Below

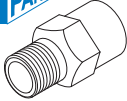

FLOW REGULATOR (1 GPM)

- Material: Nickel plated brass
- Ports: 3/8" FPT x 3/8" MPT
- Included in: Water Control Assembly (2 HP) (RPI Part #VPA002)

Fits: Water Control Assembly

RPI Part #VPR022
OEM Part # See Chart Below

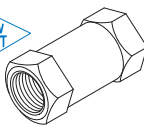

FLOW REGULATOR (0.13 GPM)

- Material: Nickel plated brass
- Ports: 3/8" FPT

Fits: Water Control Assembly

RPI Part #VPR023
OEM Part # See Chart Below

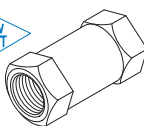

FLOW REGULATOR (0.19 GPM)

- Material: Nickel plated brass
- Ports: 3/8" FPT

Fits: Water Control Assembly

RPI Part #VPR024
OEM Part # See Chart Below

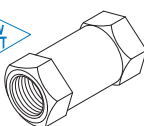

FLOW REGULATOR (0.25 GPM)

- Material: Nickel plated brass
- Ports: 3/8" FPT

Fits: Water Control Assembly

RPI Part #VPR025
OEM Part # See Chart Below

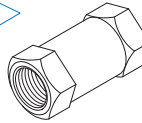

FLOW REGULATOR (1 GPM)

- Material: Nickel plated brass
- Ports: 3/8" FPT

Fits: Water Control Assembly

RPI Part #VPR026
OEM Part # See Chart Below

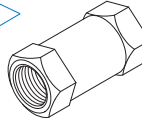

FLOW REGULATOR (.50 GPM)

- Material: Nickel plated brass
- Ports: 3/8" FPT

Fits: Water Control Assembly

RPI Part #VPR027
OEM Part # See Chart Below

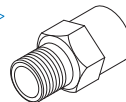

FLOW REGULATOR (0.75 GPM)

- Material: Nickel plated brass
- Ports: 3/8" FPT x 3/8" MPT

Fits: Water Control Assembly

RPI Part #VPR028
OEM Part # See Chart Below

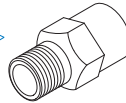

FLOW REGULATOR (1.5 GPM)

- Material: Nickel plated brass
- Ports: 3/8" FPT x 3/8" MPT

Fits: Water Control Assembly

RPI Part #VPR030
OEM Part # See Chart Below



FLOW REGULATOR (.19 GPM)

- Material: Brass
- Size: 1/4" Polyflo x 1/4" MPT

Fits: Water Control Assembly

RPI Part #VPR031
OEM Part # See Chart Below



FLOW REGULATOR (.19 GPM)

- Material: Brass
- Size: 1/4" Push-in fitting x 1/4" MPT
- See our website www.rpiparts.com for the quantity required for specific models

Fits: Vacuum System

RPI Part #VPR032
OEM Part # See Chart Below

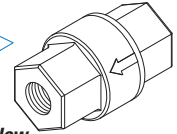

FLOW REGULATOR (.26 GPM)

- Material: Black plastic
- Ports: 1/4" FPT
- For use with vacuum pumps equipped with water recyclers only
- See our website www.rpiparts.com for the quantity required for specific models

Fits: Water Injection Assembly

RPI Part #VPR033
OEM Part # See Chart Below

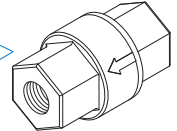

FLOW REGULATOR (.73 GPM)

- Material: Black plastic
- Ports: 1/4" FPT
- For use with vacuum pumps not equipped with water recyclers
- See our website www.rpiparts.com for the quantity required for specific models

Fits: Water Injection Assembly

RPI Part #VPV029
OEM Part # See Chart Below

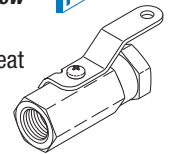

VALVE (SHUT OFF)

- Material: Brass; PTFE seat
- Ports: 1/4" FPT
- -40°F to 300°F
- 1000 PSI Max

Fits: Water Control Assembly

RPI PART #	DESCRIPTION	AIR TECHNIQUES	APOLLO/MIDMARK®	DENTALEZ®/CUSTOM AIR/RAMVAC	MATRIX/MIDMARK®	MIDMARK®	TECH WEST
VPR009	Flow Regulator (0.5 GPM)	55523		64568192			
VPR010	Flow Regulator (1 GPM)			64622010			
VPR022	Flow Regulator (0.13 GPM)			6-4622-018			
VPR023	Flow Regulator (0.19 GPM)		PW50505				
VPR024	Flow Regulator (0.25 GPM)			6-4622-019			
VPR025	Flow Regulator (1 GPM)	56010					
VPR026	Flow Regulator (0.50 GPM)		PW50507				
VPR027	Flow Regulator (0.75 GPM)	55524					
VPR028	Flow Regulator (1.5 GPM)	56011					
VPR030	Flow Regulator (.19 GPM)				10362300		
VPR031	Flow Regulator (.19 GPM)					20202900	
VPR032	Flow Regulator (.26 GPM)						WIN-RP
VPR033	Flow Regulator (.73 GPM)						WIN-2P
VPV029	Valve (Shut Off)				61301100	61301100	

Call Us Toll-Free Monday-Friday, 8:00 AM-4:30 PM (Pacific Time), (800) 221-9723

Dental Equipment

Air Techniques, Apollo/Midmark®, DentalEZ®/Custom Air/RamVac, Matrix/Midmark®, Midmark® & Tech West

RPI Part #RPT905
OEM Part # (No OEM Part # Available)



FLAG TERMINAL (1/4" QC)

- 20 per package
- Mating Tab Size: .250" x .032"
- Wire Range: #22-18 AWG
- Style: Right Angle, Female Non-Insulated
- Also available: Terminal Crimp Tool (RPI Part #RPT482)

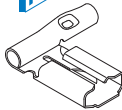

RPI Part #RPF228
OEM Part # (No OEM Part # Available)

MALE CONNECTOR

- 5 per package
 - Material: Brass
 - Size: 3/16" Tubing x 1/4" MPT;
 - Hex Size: 1/2"
 - Fits: 1/4" O.D. tube
- Fits:** Water Control Assembly

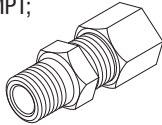

RPI Part #RPF231
OEM Part # (No OEM Part # Available)

MALE ELBOW

- 5 per package
 - Material: Brass
 - Size: 1/4" tubing x 1/8" MPT
- Fits:** Water Control Assembly

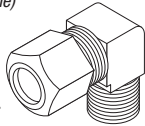

RPI Part #RPF883
OEM Part # (No OEM Part # Available)



POLYFLO NUT (1/4")

- 5 per package
 - Material: Brass
 - Fits: 1/4" O.D. plastic tube
- Fits:** Water Control Assembly

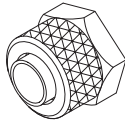

RPI Part #RPF884
OEM Part # (No OEM Part # Available)



ADAPTOR (1/8" MPT x 1/8" MPT)

- 5 per package
 - Material: Brass
 - Size: 1/8" MPT x 1/8" MPT
- Fits:** Water Control Assembly

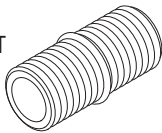

RPI Part #RPF885
OEM Part # (No OEM Part # Available)



ELBOW (1/4" POLY x 1/8" MPT)

- 2 per package
 - Material: Brass
- Fits:** Water Control Assembly

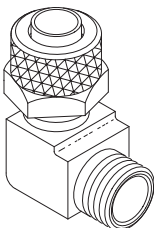

RPI Part #RPF886
OEM Part # (No OEM Part # Available)



ADAPTOR (1/8" MPT x 1/4" MPT)

- 2 per package
 - Material: Brass
- Fits:** Water Control Assembly

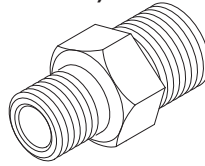

RPI Part #RPF887
OEM Part # (No OEM Part # Available)



ADAPTOR (1/4" FPT x 1/4" FPT)

- 2 per package
 - Material: Brass
- Fits:** Water Control Assembly

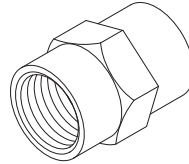

RPI Part #RPF888
OEM Part # (No OEM Part # Available)



ADAPTOR (1/8" MPT x 1/4" FPT)

- 2 per package
 - Material: Brass
- Fits:** Water Control Assembly

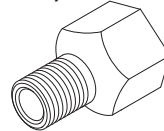

RPI Part #RPF889
OEM Part # (No OEM Part # Available)



ELBOW (1/8" FPT x 1/8" MPT)

- 2 per package
 - Material: Brass
- Fits:** Water Control Assembly

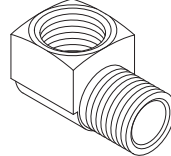

RPI Part #RPF890
OEM Part # (No OEM Part # Available)



ELBOW (1/4" FPT x 1/4" MPT)

- 2 per package
 - Material: Brass
- Fits:** Water Control Assembly

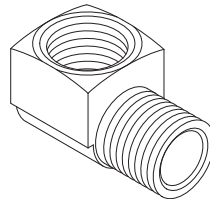

RPI Part #RPF891
OEM Part # (No OEM Part # Available)



ADAPTOR (1/8" FPT x 1/8" MPT)

- 2 per package
 - Material: Brass
- Fits:** Water Control Assembly

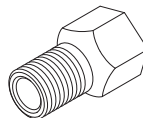

RPI Part #RPF892
OEM Part # (No OEM Part # Available)



ADAPTOR (1/8" FPT x 3/8" MPT)

- 2 per package
 - Material: Brass
- Fits:** Water Control Assembly

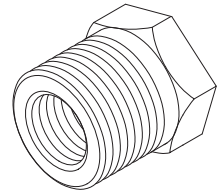

RPI Part #RPF893
OEM Part # (No OEM Part # Available)



ELBOW (1/4" POLY x 3/8" MPT)

- 2 per package
 - Material: Brass
- Fits:** Water Control Assembly

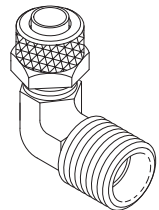

RPI Part #RPA459
OEM Part # (No OEM Part # Available)

PIPE SEALANT 567

- .20 fl. oz. (6ml) per unit
- Temperature range: -65°F to 400°F (-54° to 204°C)

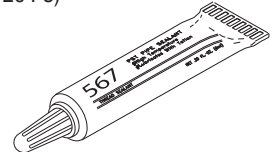

RPI Part #RPT579
OEM Part # (No OEM Part # Available)

1/4" TEFLON THREAD SEALING TAPE

- 5 per package
- 1/4" x 260" per unit

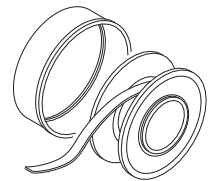

RPI Part #RPT580
OEM Part # (No OEM Part # Available)

1/2" TEFLON THREAD SEALING TAPE

- 5 per package
- 1/2" x 260" per unit

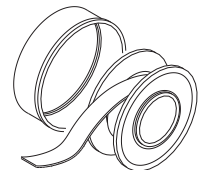

Air Techniques, Apollo/Midmark®, DentalEZ®/Custom Air/RamVac, Matrix/Midmark®, Midmark® & Tech West

DENTAL VACUUM UNITS -

SECTION
4
 PAGE
1709
 UPDATED
 09/15

RPI Part #VPV119
OEM Part # See Chart Below



CHECK VALVE (1")

- Cracking Pressure: 0.5 PSI
 - Ports: 1" FPT
 - Material: Bronze body; RPTFE seal
 - Size: 1.93" dia. x 3.50" lg.
- Fits:** Motor Assembly

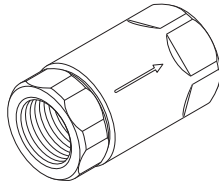

RPI Part #VPV120
OEM Part # See Chart Below



CHECK VALVE (1-1/2")

- Ports: 1-1/2" FPT
 - Material: Clear PVC
 - Size: 3.38" dia. x 5.75" lg.
- Fits:** Drain Assembly

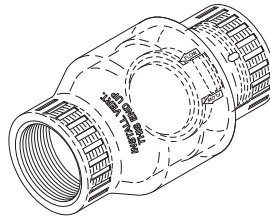

RPI Part #VPV122
OEM Part # See Chart Below



CHECK VALVE (1-1/2")

- Ports: 1-1/2" pipe compression fitting
 - Material: PVC; Nitrile (Buna N) seal
 - Size: 2.94" dia. x 5.25" lg.
 - Included in: Drain Assembly (RPI Part #VPA121)
- Fits:** Drain Assembly

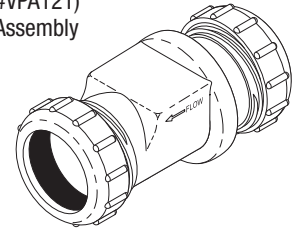

RPI Part #VPC136
OEM Part # See Chart Below



SOLIDS COLLECTOR (1-1/2")

- Ports: 1-1/2" FPT
 - Material: Black plastic body with clear plastic bowl
 - Includes: Bowl, Bowl Gasket (RPI Part #VPG081) and Screen (20 Mesh) (RPI Part #VPS140)
 - Also available: Screen (50 Mesh) (RPI Part #VPS139)
- Fits:** Separator Assembly

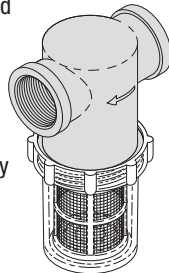

RPI Part #VPK137
OEM Part # See Chart Below



SOLIDS COLLECTOR REPLACEMENT KIT

- Includes all parts as shown
- Fits:** Solids Collector (1-1/2")

ALSO AVAILABLE BY THE CASE!

RPI Part #VPK138
OEM Part # See Chart Below

SOLIDS COLLECTOR REPLACEMENT KIT (CASE of 8)

- Includes: (8) Solids Collector Replacement Kits (RPI Part #VPK137)

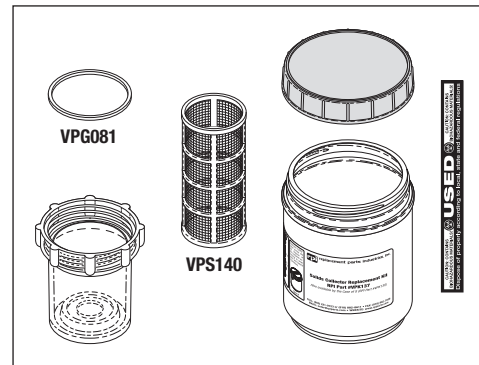

RPI Part #VPG081
OEM Part # See Chart Below

BOWL GASKET

- 3 per package
 - Material: Buna N (Nitrile)
 - Size: 3.13" OD x .13" Square
- Fits:** Solids Collector Assembly (1", 1-1/4" & 1-1/2")



RPI Part #VPS140
OEM Part # See Chart Below

SCREEN (20 MESH)

- Material: Stainless steel screen, Red plastic cage
 - Size: 2.47" OD x 5.46" lg.
- Fits:** Solids Collector (1-1/2")



RPI Part #VPS139
OEM Part # See Chart Below

SCREEN (50 MESH)











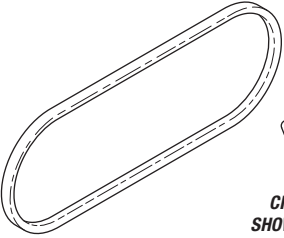

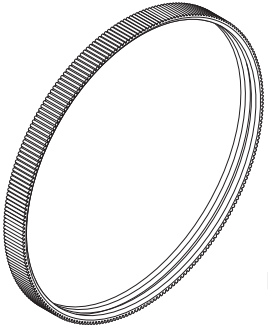
- Material: Stainless steel screen, Blue plastic cage
 - Size: 2.47" OD x 5.46" lg.
- Fits:** Solids Collector (1-1/2")

RPI PART #	DESCRIPTION	AIR TECHNIQUES	APOLLO/MIDMARK®	DENTALEZ®/CUSTOM AIR/RAMVAC	MATRIX/MIDMARK®	MIDMARK®
VPC136	Solids Collector (1-1/2")	H5181 & H5216	PVC50700 & AVAVPF2		62937303	62937303
VPG081	Bowl Gasket - 3/PKG	No OEM Part # Available	MRP70936	No OEM Part # Available	77005158	77005158
VPK137	Solids Collector Replacement Kit	H5217	AVA60031		77005169	77005169
VPK138	Solids Collector Replacement Kit (Case of 8)	No OEM Part # Available	AVA60030		77005179	77005179
VPS139	Screen (50 Mesh)	No OEM Part # Available	No OEM Part # Available		No OEM Part # Available	No OEM Part # Available
VPS140	Screen (20 Mesh)	No OEM Part # Available	No OEM Part # Available		77005079	No OEM Part # Available
VPV119	Check Valve (1")					014-0552-01
VPV120	Check Valve (1-1/2")	54075				014-0551-00
VPV122	Check Valve (1-1/2")	54139				

Call Us Toll-Free Monday–Friday, 8:00 AM–4:30 PM (Pacific Time), (800) 221-9723

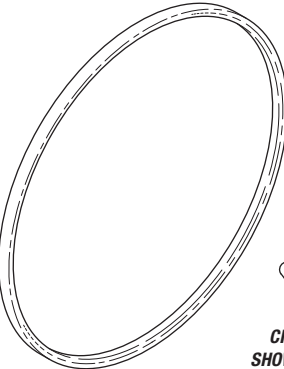
Dental Equipment

Air Techniques, Apollo/Midmark®, DentalEZ®/Custom Air/RamVac, MatrX/Midmark®, & Midmark®

IMAGE	RPI PART #	DESCRIPTION	DENTALEZ®/CUSTOM AIR/RAMVAC	MIDMARK®
 <p>CROSS SECTION SHOWN ACTUAL SIZE</p>	 VPB096	Drive Belt • Industry Part #4L370-A35F • V-Belt; Effective Belt Length: 37.0" • Size: .50" @ top x .31" thk.		016-1055-00 & 202110
	 VPB097	Drive Belt • Industry Part #4L380-A36F • V-Belt; Effective Belt Length: 38.0" • Size: .50" @ top x .31" thk.		016-1056-00
 <p>CROSS SECTION SHOWN ACTUAL SIZE</p>	 VPB098	Drive Belt • Industry Part #2/7M650JB • Effective Belt Length: 25.59" • Size: .63" @ top x .31" thk.	000273SP	
	 VPB099	Drive Belt • Industry Part #2/7MB670JB • Effective Belt Length: 26.38" • Size: .63" @ top x .31" thk.	000274SP	
	 VPB100	Drive Belt • Industry Part #2/7M580JB • Effective Belt Length: 22.83" • Size: .63" @ top x .31" thk.	002035SP	
	 VPB101	Drive Belt • Industry Part #2/7M600JB • Effective Belt Length: 23.62" • Size: .63" @ top x .31" thk.	002027SP	
	 VPB102	Drive Belt • Industry Part #2/7M545JB • Effective Belt Length: 21.46" • Size: .63" @ top x .31" thk.	002034SP	
 <p>CROSS SECTION SHOWN ACTUAL SIZE</p>	 VPB103	Drive Belt • Industry Part #A41 • V-Belt; Effective Belt Length: 43.0" • Size: .50" @ top x .31" thk. • All units require 2 Belts	0002163SP	
	 VPB104	Drive Belt • Industry Part #A42 • V-Belt; Effective Belt Length: 44.0" • Size: .50" @ top x .31" thk. • All units require 2 Belts	0002164SP	
	 VPB105	Drive Belt • Industry Part #A40 • V-Belt; Effective Belt Length: 42.0" • Size: .50" @ top x .31" thk. • All units require 2 Belts	0002360SP	



RPI Part #RPT954
OEM Part # (No OEM Part # Available)

BELT TENSIONER TESTER

- Range: 0-35 lbs. (0-15.9 kg) with a span of up to 170" lg. or belt deflection of up to 2.75"
- Includes: Pocket clip and clear storage tube
- Also available: O-Ring (RPI Part #RPO302) and O-Ring (RPI Part #RPO315)

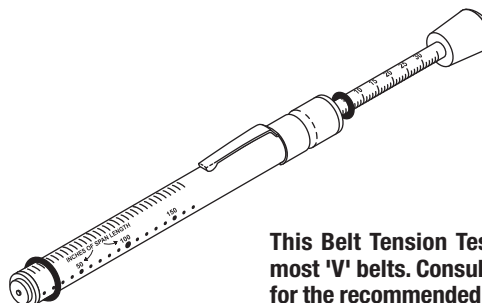

This Belt Tension Tester measures the belt tension of most 'V' belts. Consult the OEM or the belt manufacturer for the recommended belt tension for each drive system.

FAX: (818) 882-7028 • E-MAIL: order@rpiparts.com • WEBSITE: www.rpiparts.com

Air Techniques, Apollo/Midmark®, DentalEZ®/Custom Air/RamVac, MatrX/Midmark®, & Midmark®

DENTAL VACUUM UNITS -

SECTION

4

PAGE

1711

UPDATED

08/17



RPI Part #VPK128
OEM Part # See Chart Below

BRUSH KIT

- Includes all parts as shown
- Size: .25" x .25" x .69" lg.
- Radius: .38"; Spring Length: 1-1/16"
- OEM recommends replacement every 300 hours of use
- Also available: Pump Repair Kit (RPI Part #VPK127)

Fits: Liquid Evacuation Pump

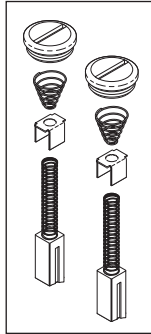

RPI Part #VPK127
OEM Part # See Chart Below

PUMP REPAIR KIT

- Includes: (1) Impeller and (1) gasket
- Also available: Brush Kit (RPI Part #VPK128)

Fits: Liquid Evacuation Pump

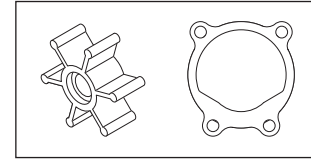

RPI Part #VPK123
OEM Part # See Chart Below

TANK WASHOUT KIT

- Includes: Adaptor (3/8" Push-In x 1/2" MPT) and (10 ft.) Tubing (1/4" ID x 3/8" OD Clear) (RPI Part #RPT959)
- Material: Clear polyethylene

Fits: CAS Tank (Cyclonic Action Separator)

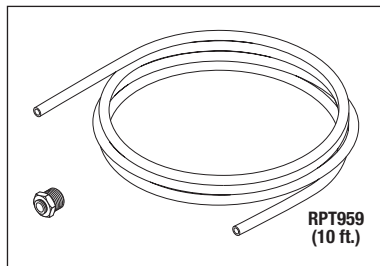

RPT959
(10 ft.)



RPI Part #RPT959
OEM Part # See Chart Below

TUBING (1/4" ID x 3/8" OD CLEAR)

- Sold by the foot (reel not included)
- Material: Clear polyethylene

Fits: 3/8" Polyflo Fitting or 1/4" Barb Fitting

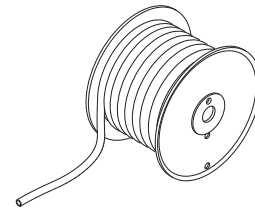

RPI Part #VPL131
OEM Part # See Chart Below

SYNTHETIC OIL (MOBIL 1®)

- Size: 1 Quart (.946 Liter) bottle
- 15W-50 (ISO grade 32)

Fits: Vacuum Unit

ALSO AVAILABLE BY THE CASE!

RPI Part #VPL132
OEM Part # See Chart Below

SYNTHETIC OIL (MOBIL 1®)
(CASE of 6)

- Case includes: (6) 1 Quart (.946 Liter) bottles



RPI Part #VPL133
OEM Part # See Chart Below

OIL-SYN GEARBOX (1 Qt.)

- Size: 1 Quart (.946 Liter) bottle
- Mobil SHC 630 (ISO grade 220)

Fits: Vacuum Unit

ALSO AVAILABLE BY THE CASE!

RPI Part #VPL134
OEM Part # See Chart Below

OIL-SYN GEARBOX
(CASE of 12)

- Case includes: (12) 1 Quart (.946 Liter) bottles



RPI PART #	DESCRIPTION	AIR TECHNIQUES	DENTAL EZ®/CUSTOM AIR/RAMVAC	MATR X/MIDMARK®	MIDMARK®
RPT959	Tubing (1/4" ID x 3/8" OD Clear Poly)	54601		77002004	77002004
VPK123	Tank Washout Kit			77008009 & 77002004	77008009 & 77002004
VPK127	Pump Repair Kit			77001507	77001507
VPK128	Brush Kit			77001506	77001506
VPL131	Synthetic oil (Mobil 1®)		No OEM Part # Available		
VPL132	Synthetic oil (Mobil 1®) (Case of 6)		380706		
VPL133	Oil-Syn Gearbox (1 Qt.)				064-0028-01
VPL134	Oil-Syn Gearbox (Case of 12)				No OEM Part # Available

Call Us Toll-Free Monday-Friday, 8:00 AM-4:30 PM (Pacific Time), (800) 221-9723

Dental Equipment

Air Techniques, Apollo/Midmark®, DentalEZ®/Custom Air/RamVac, Matrx/Midmark®, & Midmark®

Service Tip: Air filter life depends on vacuum usage, nature of environment, and amount of aspirated material. Inspect air filter every 1,000 hours and replace every 2,000 hours or when visibly dirty. Also, inspect the oil filter every 1,000 hours and change the oil filter element every 2,000 hours or when changing the oil.

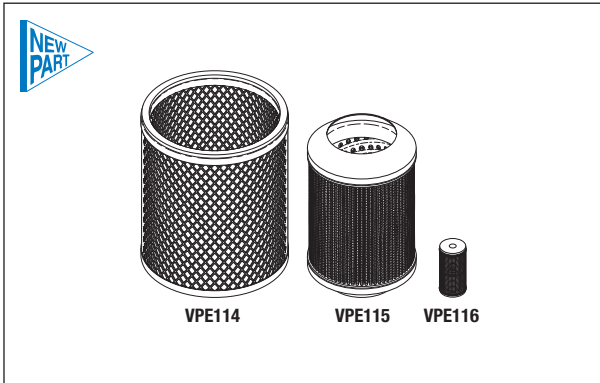

RPI Part #VPK113
OEM Part #003740

FILTER KIT

- See **Service Tip** below
 - Includes all parts as shown
- Fits:** Vacuum Controller Assembly

Models: DentalEZ/Custom Air/RamVac:
Bulldog 550, Bulldog QT1, Bulldog QT2, Bulldog QT3

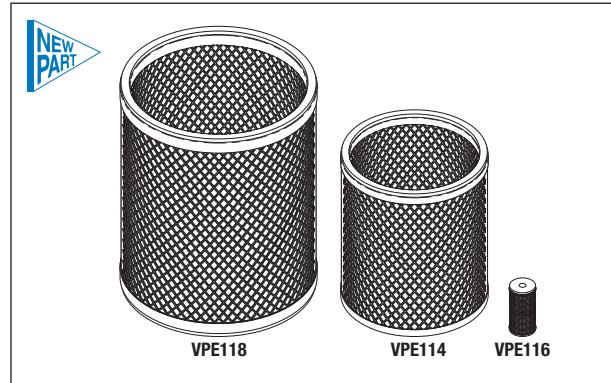

RPI Part #VPK117
OEM Part #003750

FILTER KIT

- See **Service Tip** below
 - Includes all parts as shown
- Fits:** Vacuum Controller Assembly

Models: DentalEZ/Custom Air/RamVac:
Bison 3, Bison 5, Bison 7, Bison 9



RPI Part #VPE116
OEM Part #310705

OIL FILTER ELEMENT

- Size: .78" OD x 1.62" lg.
- Material: 200 Mesh stainless steel and 2 Nitrile (Buna N) O-rings
- See **Service Tip** below
- Includes: PM Sticker

Fits: Vacuum Controller Assembly
Models: DentalEZ/Custom Air/RamVac:
Bison 3, Bison 5, Bison 7, Bison 9, Bulldog 550, Bulldog QT1, Bulldog QT2, Bulldog QT3

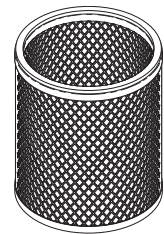

RPI Part #VPE114
OEM Part #003550SP

FILTER ELEMENT

- 5 Micron
- Size: 4.56" OD x 5.36" lg.
- See **Service Tip** below
- Includes: PM Sticker

Fits: Vacuum Controller Assembly
Models: DentalEZ/Custom Air/RamVac:
Bison 3, Bison 5, Bison 7, Bison 9, Bulldog 550, Bulldog QT1, Bulldog QT2, Bulldog QT3

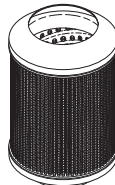

RPI Part #VPE115
OEM Part #003548SP

FILTER ELEMENT

- 3 Micron
- Size: 3.40" OD x 5.15" lg.
- See **Service Tip** below
- Includes: PM Sticker

Fits: Vacuum Controller Assembly
Models: DentalEZ/Custom Air/RamVac:
Bulldog 550, Bulldog QT1, Bulldog QT2, Bulldog QT3

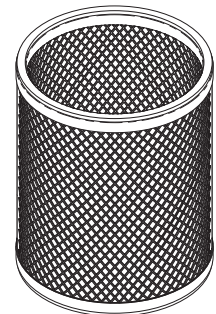

RPI Part #VPE118
OEM Part #003549SP

FILTER ELEMENT

- 5 Micron
- Size: 6.00" OD x 7.45" lg.
- See **Service Tip** below
- Includes: PM Sticker

Fits: Vacuum Controller Assembly
Models: DentalEZ/Custom Air/RamVac:
Bison 3, Bison 5, Bison 7, Bison 9



RPI Part #VPA125
OEM Part #002-1448-00

FLOAT ASSEMBLY (NEW)

- 2 Float Switches
- **Service Tip:** Earlier versions of the PowerVac had three float switches, later PowerVac models and all PowerVac G models used two float switches. The middle float switch was for the liquid Evacuation Pump Option. If you have a liquid Evacuation pump connected to an earlier Power Vac you must replace the float assembly with a three Float Switch Assembly (RPI Part #VPA126). If there is no Evacuation pump connected to the PowerVac, you can replace the float with this version of the two float switch assembly.
- Includes: Two float switches with harness, float assembly bracket, PVC tank adaptor, cable gland and plug assembly with cable clamp.

Fits: Separator Tank

Models: **Midmark®:** PowerVac G G3, PowerVac G G5, PowerVac G G6, PowerVac G G7, PowerVac G G10 & PowerVac G G14 (all Serial Numbers); PowerVac P3, PowerVac P5, PowerVac P6, PowerVac P7, PowerVac P10 & PowerVac P14 (Serial # V975825 to Present)

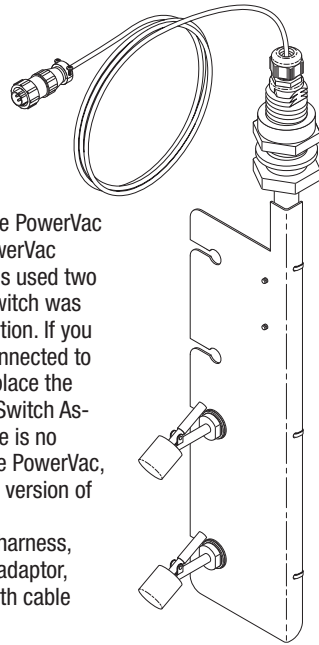

RPI Part #VPA126
OEM Part #015-2067-00

FLOAT ASSEMBLY (OLD)

- 3 Float Switches
- **Service Tip:** Earlier versions of the PowerVac had three float switches, later PowerVac models and all PowerVac G models used two float switches. The middle float was for the liquid Evacuation Pump Option. If you have a liquid Evacuation pump connected to an earlier Power Vac you can replace the float assembly with this three float switch assembly. If there is no Evacuation pump connected to the PowerVac, you can replace the float assembly with the two Float Switch Assembly (RPI Part #VPA125).
- Includes: Three float switches with harness, float assembly bracket, PVC tank adaptor, cable gland and plug assembly with cable clamp

Fits: Separator Tank

Models: **Midmark®:** PowerVac P3, PowerVac P5 & PowerVac P7 (Serial #V245092 to V975824 & 0611P3P0000 thru Present)

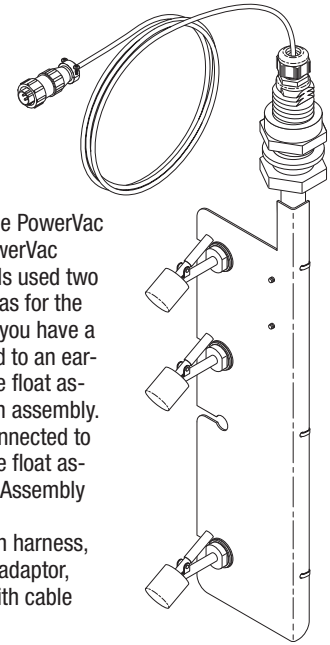

RPI Part #VPG106
OEM Part #053-1616-00

GASKET (SEPARATOR LID)

- Size: 12.62" OD X .46" thk.
- Material: Nitrile (Buna N); 70 Duro

Fits: Separator Lid and Tank

Models: **Midmark®:** PowerVac P3, PowerVac P5 & PowerVac P7 (Serial #V245092 to V975824 & 0611P3P0000 thru Present)

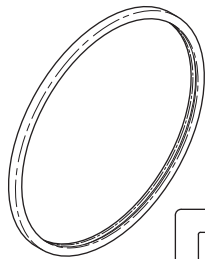

RPI Part #VPG108
OEM Part #65950000

FLANGE GASKET

- Size: 6.05" OD x .13" thk.
- Material: Nitrile (Buna N); 70 Duro

Fits: Separator Tank

Models: **Matrx/Midmark®:** DryMax 4000/8000

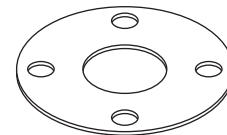

RPI Part #VPG107
OEM Part #053-2159-00

GASKET (SEPARATOR LID)

- Size: 21.50" OD x .34" thk.
- Material: Nitrile (Buna N); 70 Duro
- See **Note 1** below for quantity required for each model

Fits: Separator Lid and Tank

Models: **Midmark®:** PowerVac G G3, PowerVac G G5, PowerVac G G6, PowerVac G G7, PowerVac G G10 & PowerVac G G14, PowerVac P6, PowerVac P10 & PowerVac P14 (all Serial Numbers); PowerVac P3, PowerVac P5 & PowerVac P7 (Serial # V975825 to Present)

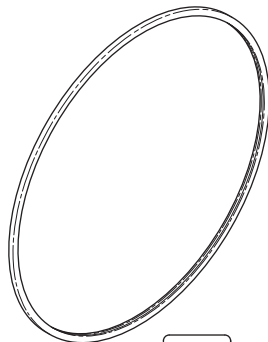

RPI Part #VPG109
OEM Part #54619

CAS COVER GASKET

- Size: 15.27" OD x .21" thk.
- Material: Nitrile (Buna N); 50 Duro with adhesive backing

Fits: CAS Cover (Cyclonic Action Separator)

Models: **Air techniques:** CAS 4-Gallon, CAS 4-Gallon with Guardian, CAS 8-Gallon (New Style), CAS 8-Gallon (Old Style), CAS 8-Gallon with Guardian & CAS 20-Gallon

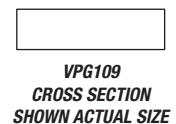
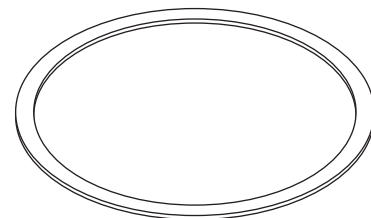

Note 1: **Midmark:** PowerVac P3, P5, P7, PowerVac G G3, G5, G7 have one separator tank; and PowerVac P6, P10, P14, PowerVac G G6, G10 & G14 have two separator tanks..

Dental Equipment

Air Techniques, Apollo/Midmark®, DentalEZ®/Custom Air/RamVac, Matrx/Midmark®, & Midmark®

RPI Part #VPV124
OEM Part #029-3811-00



VACUUM RELIEF VALVE

- Material: Dark grey plastic
- Preset @ approx. 5 lb. (adjustable)
- Includes: Vacuum Relief Valve (1" (RPI Part #VPV060) and Foam Element (RPI Part #CMF013)
- See **Note 1** below for quantity required for each model

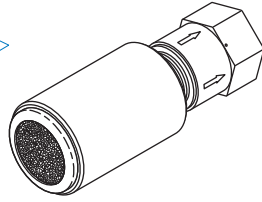

Fits: Separator Assembly

Models: **Midmark®:** PowerVac P3, PowerVac P5, PowerVac P6, PowerVac P7, PowerVac P10 & PowerVac P14

Note 1: **Midmark:** PowerVac P3, P5 & P7 require 1 each; and PowerVac P6, P10 & P14 require 2 each.

RPI Part #VPA121
OEM Part #54660



DRAIN ASSEMBLY

- Includes: Check Valve (1-1/2" (RPI Part #VPV122)

Fits: Separator Tank

Models: **Air techniques:** CAS 4-Gallon, CAS 8-Gallon (New Style), CAS 8-Gallon (Old Style) & CAS 20-Gallon

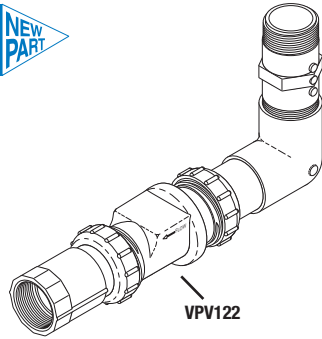

RPI Part #VPS129
OEM Part #62950600



FLOAT SWITCH (FAIL-SAFE)

- SPST; 24" lg.
- 1/2" MPT mounting thread
- Material: Polypropylene

Fits: Separator Tank

Models: **Matrx/Midmark®:** DryMax 4000/8000

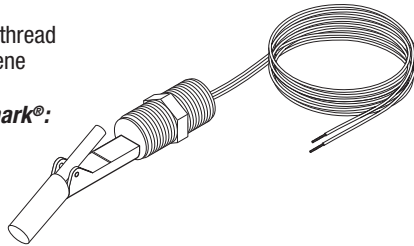

RPI Part #VPV141
OEM Part #77002144

VACUUM RELIEF VALVE (PLATFORM)

- Port: 3/4" MPT
- Material: PVC
- Includes: Vacuum Gauge (Liquid Filled) (RPI Part #VPG044) and Foam Element (RPI Part #CMF013)

Fits: Twin Intake Manifold Assembly or Platform Mount

Models: **Matrx/Midmark®:** Maximizer 1000-2P, Maximizer 2000-2P, Minimizer 1000-2P & Minimizer 2000-2P;

Midmark®: CV6, CV6R, CV10 & CV10R

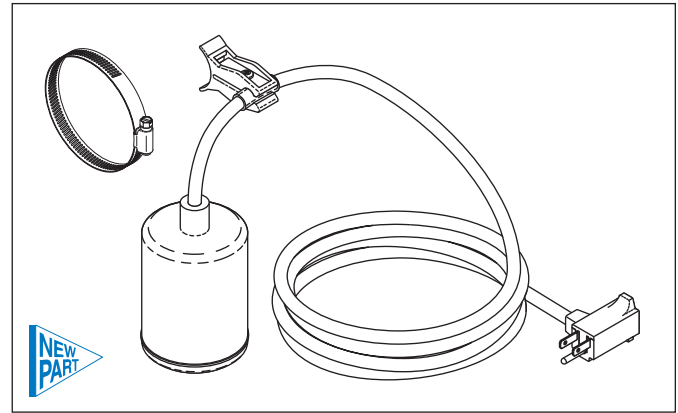
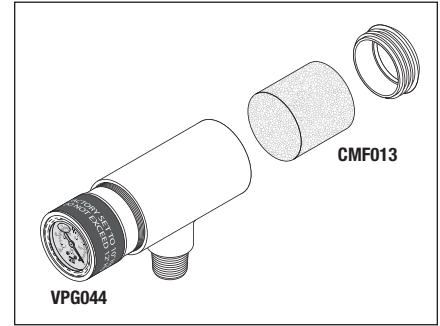

RPI Part #VPS130
OEM Part #62950500

FLOAT SWITCH (DIFFERENTIAL)

- 115VAC, N.O.
- Size: 3" dia. x 3" lg. float, with 10' lg. cable
- Includes: Hose clamp and pipe/cable clamp

Fits: Separator Tank

Models: **Matrx/Midmark®:** DryMax 4000/8000

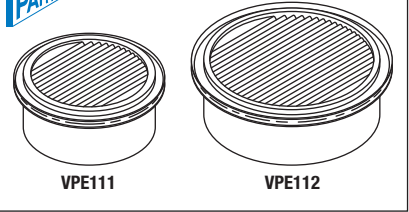

RPI Part #VPK110
OEM Part #005301SP

FILTER KIT

- Includes: Filter Element (RPI Part #VPE111), Filter Element (RPI Part #VPE112) and PM Stickers

Fits: Vacuum Controller Assembly

Model:

DentalEZ/Custom Air/RamVac: Badger

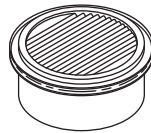

RPI Part #VPE111
OEM Part #004691SP

FILTER ELEMENT

- 5 Micron polyester filter
- Size: 3.00" OD x 1.00" lg.
- Includes: PM Sticker
- Included in: Filter Kit (RPI Part #VPK110)

Fits: Vacuum Controller Assembly

Model:

DentalEZ/Custom Air/RamVac: Badger

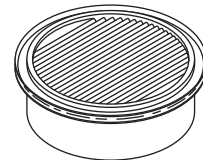

RPI Part #VPE112
OEM Part #004876SP

FILTER ELEMENT

- 5 Micron polyester filter
- Size: 4.00" OD x 1.38" lg.
- Includes: PM Sticker
- Included in: Filter Kit (RPI Part #VPK110)

Fits: Vacuum Controller Assembly

Model:

DentalEZ/Custom Air/RamVac: Badger

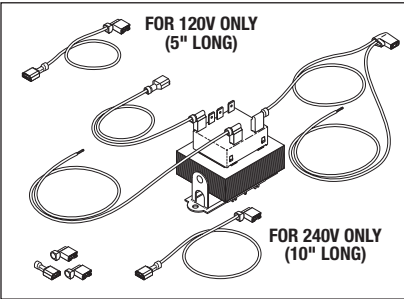

RPI Part #VPT142
OEM Part # See Chart Below

TRANSFORMER

- Primary: 120/208/240VAC; 50/60Hz.
 - Secondary: 24VAC @ 40A
 - Includes all parts as shown
- Fits:** Electrical Control Box

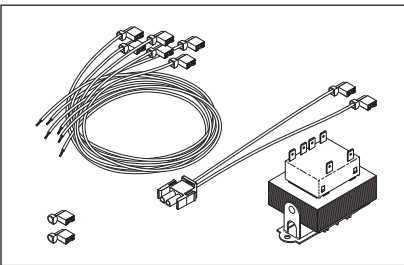

RPI Part #VPT143
OEM Part # See Chart Below

TRANSFORMER

- Primary: 120/208/240VAC; 50/60Hz.
 - Secondary: 24VAC @ 40A
 - Includes all parts as shown
- Fits:** Electrical Control Box

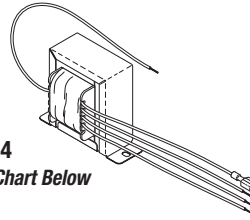

RPI Part #VPT144
OEM Part # See Chart Below

TRANSFORMER

- Primary: 115/230VAC; 50/60Hz.
 - Secondary: 24VAC @ 30A
- Fits:** Electrical Control Box

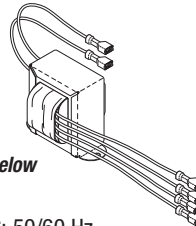

RPI Part #VPT145
OEM Part # See Chart Below

TRANSFORMER

- Primary: 115/230VAC; 50/60 Hz.
 - Secondary: 24VAC @ 40A
 - Auto-Reset thermal protector
- Fits:** Electrical Control Box

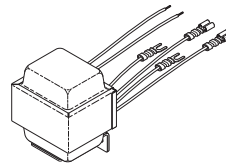

RPI Part #VPT146
OEM Part # See Chart Below

TRANSFORMER

- Primary: Dual 120VAC; 60Hz.
 - Secondary: 24VAC @ 25A
- Fits:** Electrical Control Box

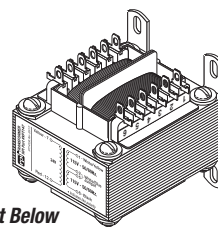

RPI Part #VPT147
OEM Part # See Chart Below

TRANSFORMER

- Primary: Dual 115/230VAC; 50/60Hz.
 - Secondary: 24VAC @ 3.33A
- Fits:** Electrical Control Box

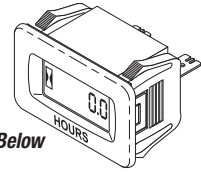

RPI Part #VPM171
OEM Part # See Chart Below

HOUR METER

- AC/DC voltage input
 - Panel cutout: .952" x 1.452"
 - Counts in Tenths, then whole numbers up to 99.999 hours (Non-resettable)
 - Internal lithium battery (Non-replaceable), Battery life of 12 years minimum
- Fits:** Electrical Control Box

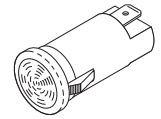

RPI Part #VPL180
OEM Part # See Chart Below

PILOT LIGHT (GREEN)

- 125VAC, 1/3W; 3/16" Tabs
 - .50" dia. mounting hole
- Fits:** Electrical Control Box

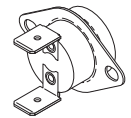

RPI Part #VPT172
OEM Part # See Chart Below

THERMOSTAT

- Opens @ 77°F and Closes at 95°F
 - 125VAC @ 15A / 250VAC @ 10A
 - 1/4" Tabs
- Fits:** Vacuum Base Unit

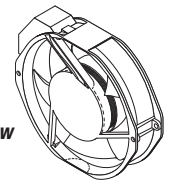

RPI Part #VPF181
OEM Part # See Chart Below

FAN

- 0.196A @ 230VAC
 - Size: 5.91" L x 6.38" H x 1.50" W
 - Aluminum housing; Polycarbonate impeller; Ball bearing construction
 - 3200 RPM; 212 CFM
- Fits:** Vacuum Base Unit

RPI PART #	DESCRIPTION	AIR TECHNIQUES	APOLLO/MIDMARK®	DENTAL EZ®/CUSTOM AIR/RAMVAC	MATRIX/MIDMARK®	MIDMARK®	TECH WEST
VPF181	Fan					20224500 & SEA95540	
VPL180	Pilot Light (Green)					015-1304-00	
VPM171	Hour Meter					20235600	
VPT142	Transformer	54623, 54375, 55866, 55867 & 56325					
VPT143	Transformer		ETR10500			002-1442-00 & 015-196-00	
VPT144	Transformer				77001471 & 77001434		
VPT145	Transformer			64568195			
VPT146	Transformer						PT-100
VPT147	Transformer	53182					
VPT172	Thermostat					65972500	

Call Us Toll-Free Monday-Friday, 8:00 AM-4:30 PM (Pacific Time), (800) 221-9723

Dental Equipment

Air Techniques, Apollo/Midmark®, DentalEZ®/Custom Air/RamVac, Matrix/Midmark®, Midmark® & Tech West

Air Techniques, Apollo/Midmark®, DentalEZ®/Custom Air/RamVac, Matrix/Midmark®, Midmark® & Tech West

DENTAL VACUUM UNITS -

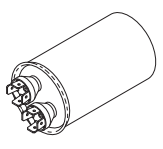

RPI Part #VPC152
OEM Part # See Chart Below
CAPACITOR (15µf, 370VAC)

- Run capacitor
- Size: 1.76" dia. x 2.37/2.95" lg.
- 15µf, 370VAC, 50/60Hz.
- Quad 1/4" Tabs

Fits: Motor Assembly

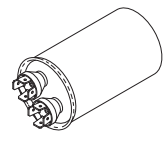

RPI Part #VPC153
OEM Part # See Chart Below
CAPACITOR (25µf, 370VAC)

- Run capacitor
- Size: 1.76" dia. x 2.95/3.00" lg.
- 25µf, 370VAC, 50/60Hz.
- Quad 1/4" Tabs

Fits: Motor Assembly

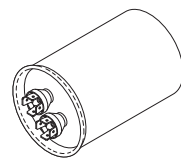

RPI Part #VPC154
OEM Part # See Chart Below
CAPACITOR (50µf, 480VAC)

- Run capacitor
- Size: 2.50" dia. x 3.75" lg.
- 50µf, 480VAC, 50/60Hz.
- Quad 1/4" Tabs
- Note: Fits Model STS-5: Serial #259 and above

Fits: Motor Assembly

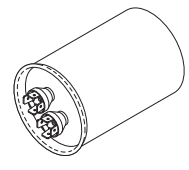

RPI Part #VPC155
OEM Part # See Chart Below
CAPACITOR (60µf, 440VAC)

- Run Capacitor
- Size: 2.50" dia x 3.75" lg.
- 60µf, 440VAC, 50/60Hz.
- Quad 1/4" Tabs
- Note: Fits Model STS-5: Serial #258 and below

Fits: Motor Assembly

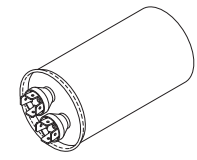

RPI Part #VPC156
OEM Part # See Chart Below
CAPACITOR (60µf, 370VAC)

- Run capacitor
- Size: 2.00" dia. x 3.62"/3.75" lg.
- 60µf, 370VAC, 50/60Hz.
- Quad 1/4" Tabs

Fits: Motor Assembly

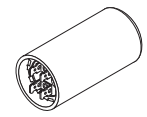

RPI Part #VPC157
OEM Part # See Chart Below
CAPACITOR (189-227µf, 125VAC)

- Start capacitor
- Size: 1.43" dia. x 2.75" lg.
- 189-227µf, 125VAC, 50/60Hz.
- Dual 1/4" Tabs

Fits: Motor Assembly

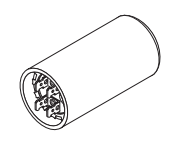

RPI Part #VPC158
OEM Part # See Chart Below
CAPACITOR (250-300µf, 110VAC)

- Start capacitor
- Size: 1.43" dia. x 2.75/3.38" lg.
- 250-300µf, 110VAC, 50/60Hz.
- Dual 1/4" Tabs

Fits: Motor Assembly

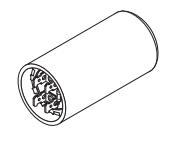

RPI Part #VPC159
OEM Part # See Chart Below
CAPACITOR (295-355µf, 125VAC)

- Start capacitor
- Size: 2.06" dia x 3.37" lg.
- 295-355µf, 125VAC, 50/60Hz.
- Dual 1/4" Tabs
- Includes: 68K bleed resistor installed

Fits: Motor Assembly

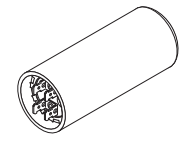

RPI Part #VPC161
OEM Part # See Chart Below
CAPACITOR (378-454µf, 110VAC)

- Start capacitor
- Size: 1.44/1.81" dia. x 3.38/3.65" lg.
- 378-454µf, 110VAC, 50/60Hz.
- Dual 1/4" Tabs

Fits: Motor Assembly

RPI PART #	DESCRIPTION	AIR TECHNIQUES	APOLLO/MIDMARK®	DENTALEZ®/CUSTOM AIR/RAMVAC	MATRIX/MIDMARK®	MIDMARK®	TECH WEST
VPC152	Capacitor (15µf, 370VAC)			No OEM Part # Available			
VPC153	Capacitor (25µf, 370VAC)				77001158		SMC-2
VPC154	Capacitor (50µf, 480VAC)	54323					
VPC155	Capacitor (60µf, 440VAC)	54323					
VPC156	Capacitor (60µf, 370VAC)					10560900	
VPC157	Capacitor (189-227µf, 125VAC)			No OEM Part # Available			
VPC158	Capacitor (250-300µf, 110VAC)	55683	HFA10010				
VPC159	Capacitor (295-355µf, 125VAC)	55684	HFA10040		77001458 & 77001459	77001458 & 77001459	
VPC161	Capacitor (378-454µf, 110VAC)				61894900		

FAX: (818) 882-7028 • E-MAIL: order@rpiparts.com • WEBSITE: www.rpiparts.com

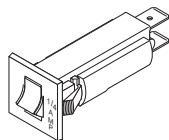

RPI Part #VPB164
OEM Part # See Chart Below

CIRCUIT BREAKER (1/4A)

- 1/4A @ 250VAC
- 1/4" Tabs
- Panel cutout: 5/8" dia.
- Push to reset
- **Important Note:** Verify the amperage of the circuit breaker you are replacing and be sure to use the same amperage.

Fits: Electrical Control Box

Models: Newer models of VacStar 50, VacStar 50H, VacStar 80 & VacStar 80H

Notes: VacStar 50, VacStar 50H, VacStar 80 & VacStar 80H require 2 each.

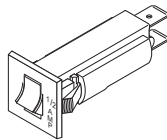

RPI Part #VPB182
OEM Part # See Chart Below

CIRCUIT BREAKER (1/2A)

- 1/2 A @ 250VAC
- 1/4" Tabs
- Panel cutout: 5/8" dia.
- Push to reset

Fits: Electrical Control Box

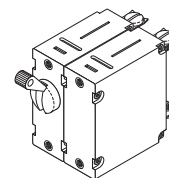

RPI Part #VPB168
OEM Part # See Chart Below

CIRCUIT BREAKER (15A)

- 15A @ 250VAC
- #8-32 screw lugs
- Panel cutout: 9/16" dia.
- On/Off switch

Fits: Electrical Control Box

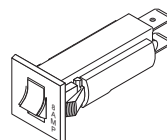

RPI Part #VPB165
OEM Part # See Chart Below

CIRCUIT BREAKER (8A)

- 8A @ 250VAC
- 1/4" Tabs
- Panel cutout: 5/8" dia.
- Push to reset

Fits: Electrical Control Box

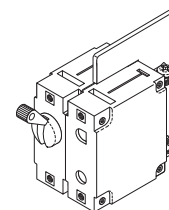

RPI Part #VPB169
OEM Part # See Chart Below

CIRCUIT BREAKER (16A)

- 16A @ 250VAC
- #10-32 screw lugs
- On/Off switch

Fits: Electrical Control Box

Notes: VacStar 50, VacStar 50H, VacStar 80 & VacStar 80H require 2 each.

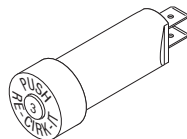

RPI Part #VPB167
OEM Part # See Chart Below

CIRCUIT BREAKER (3A)

- 3A @ 250VAC or 50VDC
- 1/4" Tabs
- Panel cutout: 5/8" dia.
- Push to reset
- **Important Note:** Verify the amperage of the circuit breaker you are replacing and be sure to use the same amperage.

Fits: Electrical Control Box

Models: Older models of VacStar 50, VacStar 50H, VacStar 80 & VacStar 80H

Notes: VacStar 50, VacStar 50H, VacStar 80 & VacStar 80H require 2 each.

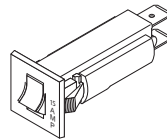

RPI Part #VPB166
OEM Part # See Chart Below

CIRCUIT BREAKER (15A)

- 15A @ 250VAC
- 1/4" Tabs
- Panel cutout: 5/8" dia.
- Push to reset

Fits: Electrical Control Box

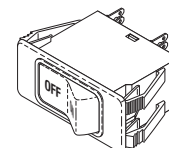

RPI Part #VPS170
OEM Part # See Chart Below

**POWER SWITCH/
 CIRCUIT BREAKER (1/2A)**

- 1/2A @ 250VAC or 50VDC
- Push-in panel mount; Dual blade terminals

Fits: Electrical Control Box

RPI PART #	DESCRIPTION	AIR TECHNIQUES	APOLLO/MIDMARK®	DENTALEZ®/CUSTOM AIR/RAMVAC	MIDMARK®
VPB164	Circuit Breaker (1/4A)	117690			
VPB165	Circuit Breaker (8A)			3801-911	
VPB166	Circuit Breaker (15A)			3801-120	
VPB167	Circuit Breaker (3A)	53180			
VPB168	Circuit Breaker (15A)	54247			
VPB169	Circuit Breaker (16A)	56149 & 56148			
VPB182	Circuit Breaker (1/2A)	117061			
VPS170	Power Switch/Circuit Breaker (1/2A)		ECS10422		ECS10422

Call Us Toll-Free Monday–Friday, 8:00 AM–4:30 PM (Pacific Time), (800) 221-9723

Dental Equipment

Air Techniques, Apollo/Midmark®, DentalEZ®/Custom Air/RamVac, Matrix/Midmark®, Midmark® & Tech West

Air Techniques, Apollo/Midmark®, DentalEZ®/Custom Air/RamVac, Matrix/Midmark®, Midmark® & Tech West

DENTAL VACUUM UNITS -

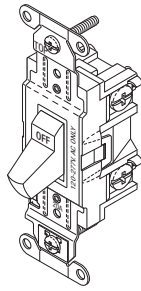

RPI Part #VPS177
OEM Part # See Chart Below

POWER SWITCH

- Toggle switch (On/Off)
- 20A @ 120/277VAC, SPDT
- Screw terminals

Fits: Electrical Control Box

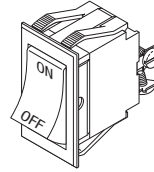

RPI Part #VPS179
OEM Part # See Chart Below

POWER SWITCH

- Rocker switch (On/Off)
- 20A @ 120/277VAC, SPDT
- Screw terminals
- Panel cutout: 1.450" x .830"

Fits: Electrical Control Box

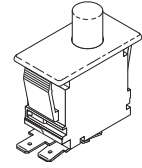

RPI Part #MIS255
OEM Part # See Chart Below

LIMIT SWITCH

- Momentary (on - off)
- 0.1A @ 125VAC, SPDT
- 3/16" tabs
- Panel cutout: 1.125" x .550"

Fits: Front Panel Controls and Front Box Assembly

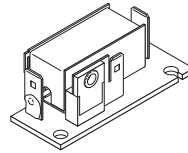

RPI Part #VPS173
OEM Part # See Chart Below

SWITCH (SOLID STATE 115VAC)

- 115VAC motor start switch
- (2) 1/4" and (1) 3/16" Tabs

Fits: Motor

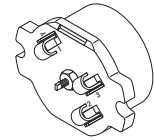

RPI Part #VPS175
OEM Part # See Chart Below

THERMAL OVERLOAD SWITCH

- Automatic reset
- Opens @ 302°F; Closes @ 239°F
- 120VAC @ 40A / 240VAC @ 30A

Fits: Electrical Control Box

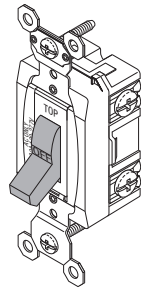

RPI Part #VPS178
OEM Part # See Chart Below

POWER SWITCH

- Toggle switch (On/Off)
- 20A @ 120/277VAC, SPDT
- Screw terminals

Fits: Electrical Control Box

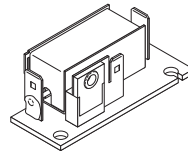

RPI Part #VPS174
OEM Part # See Chart Below

SWITCH (SOLID STATE 220VAC)

- 220VAC motor start switch
- (2) 1/4" and (1) 3/16" Tabs

Fits: Motor

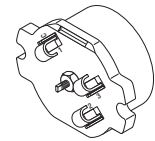

RPI Part #VPS176
OEM Part # See Chart Below

THERMAL OVERLOAD SWITCH

- Automatic reset
- Opens @ 275°F; Closes @ 216°F
- 120VAC @ 40A / 240VAC @ 30A

Fits: Electrical Control Box

RPI PART #	DESCRIPTION	AIR TECHNIQUES	APOLLO/MIDMARK®	MATRIX/MIDMARK®	MIDMARK®
MIS255	Limit Switch				015-1055-00 & 62977400
VPS173	Switch (Solid State 115VAC)	55681			
VPS174	Switch (Solid State 220VAC)	55682			
VPS175	Thermal Overload Switch	55677			
VPS176	Thermal Overload Switch	55698			
VPS177	Power Switch	85838			
VPS178	Power Switch		ECS10417	77001130	77001130
VPS179	Power Switch	55993			

FAX: (818) 882-7028 • E-MAIL: order@rpiparts.com • WEBSITE: www.rpiparts.com

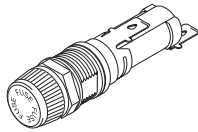

RPI Part #RPH638
OEM Part # See Chart Below

FUSE HOLDER

- Accommodates 1/4" x 1-1/4" fuse
 - 20A @ 250VAC
 - 3/16" Tabs
 - Mounting hole size: .500" dia.
 - Includes mounting hardware
- Fits:** Electrical Control Box

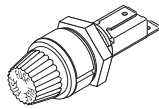

RPI Part #RPH988
OEM Part # See Chart Below

FUSE HOLDER

- Accommodates 1/4" x 1-1/4" fuse
 - 20A @ 250VAC
 - 3/16" Tabs
 - Mounting hole size: .500" dia.
 - Includes mounting hardware
 - Also available for Tech West Vacuums:
Fuse (1/4A, 250V) (RPI Part #RPF059)
- Fits:** Electrical Control Box

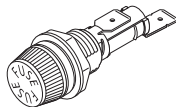

RPI Part #RPH989
OEM Part # See Chart Below

FUSE HOLDER

- Accommodates 1/4" x 1-1/4" fuse
 - 20A @ 250VAC
 - 1/4" Tabs
 - Mounting hole size: .500" dia.
 - Includes mounting hardware
- Fits:** Electrical Control Box

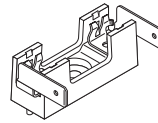

RPI Part #RPH990
OEM Part # See Chart Below

FUSE HOLDER

- Accommodates 1/4" x 1-1/4" fuse
 - 30A @ 250VAC
 - 1/4" Tabs
 - Surface mount
- Fits:** Electrical Control Box

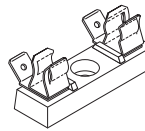

RPI Part #RPH991
OEM Part # See Chart Below

FUSE HOLDER

- Accommodates 1/4" x 1-1/4" fuse
 - 30A @ 250VAC
 - 1/4" Tabs
 - Surface mounting
- Fits:** Electrical Control Box

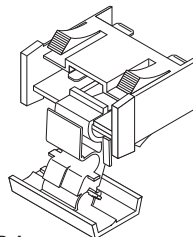

RPI Part #RPH992
OEM Part # See Chart Below

FUSE HOLDER

- Accommodates 1/4" x 1-1/4" fuse
 - 15A @ 250VAC
 - 1/4" Tabs
 - Flip-Top, shock-safe, squeeze cover to open
 - Panel cutout: .688" x 1.455"
 - Fuse carrier holds spare fuse
- Fits:** Electrical Control Box

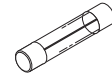

RPI Part #RPF996
OEM Part # See Chart Below

FUSE (150mA, 250V)

- 1/4" x 1-1/4" - TIME DELAY
- 5 per package
 - Type: 3 Glass AG; time delay
- Fits:** Fuse Holder

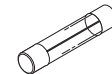

RPI Part #RPF994
OEM Part # See Chart Below

FUSE (3/10A, 250V)

- 1/4" x 1-1/4" - TIME DELAY
- 5 per package
 - Type: 3 Glass AG, time delay
- Fits:** Fuse Holder

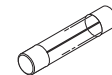

RPI Part #RPF995
OEM Part # See Chart Below

FUSE (1/8A, 250V)

- 1/4" x 1-1/4" - TIME DELAY
- 5 per Package
 - Type: 3 Glass AG; time delay
- Fits:** Fuse Holder

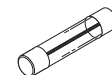

RPI Part #RPF993
OEM Part # See Chart Below

FUSE (3/4A, 250V)

- 1/4" x 1-1/4" - TIME DELAY
- 5 per package
 - Type: 3 Glass AG; time delay
- Fits:** Fuse Holder

RPI PART #	DESCRIPTION	AIR TECHNIQUES	APOLLO/MIDMARK®	DENTALEZ®/CUSTOM AIR/RAMVAC	MATRIX/MIDMARK®	MIDMARK®	TECH WEST
RPF993	Fuse (3/4A, 250V)				77001402		
RPF994	Fuse (3/10A, 250V)			64568131	63882538		
RPF995	Fuse (1/8A, 250V)					015-0346-36	
RPF996	Fuse (150mA, 250V)			64568130			
RPH638	Fuse Holder	90219					
RPH988	Fuse Holder						FH-100
RPH989	Fuse Holder		EMS10935			65927500	
RPH990	Fuse Holder				62977600	015-1534-00	
RPH991	Fuse Holder			64561004			
RPH992	Fuse Holder				61884100		

Call Us Toll-Free Monday-Friday, 8:00 AM-4:30 PM (Pacific Time), (800) 221-9723

Dental Equipment

Air Techniques, Apollo/Midmark®, DentalEZ®/Custom Air/RamVac, Matrix/Midmark®, Midmark® & Tech West

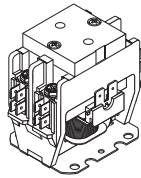

RPI Part #VPR148
OEM Part # See Chart Below

RELAY (ELECTRICAL CONTACTOR)

- Coil: 24VAC, 11 ohms
- 2 pole; Contacts rated at 30A
- 1/4" Tabs

Fits: Vacuum Electrical Control Box

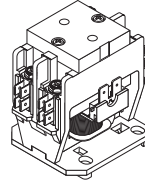

RPI Part #VPR150
OEM Part # See Chart Below

RELAY (ELECTRICAL CONTACTOR)

- Coil: 24VAC, 11 ohms
- 2 pole; Contacts rated at 30A
- 1/4" Quad Tabs
- DIN mounting bracket (35mm Style)

Fits: Vacuum Electrical Control Box

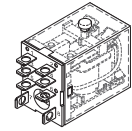

RPI Part #VPR162
OEM Part # See Chart Below

RELAY

- Coil: 24VAC, 180 ohms
- DPDT rated at 10Amps
- Plug-in or solder terminals
- LED indicator and Push-to-Test button
- Also available: Relay Socket (RPI Part #VPS163)

Fits: Vacuum Electrical Control Box

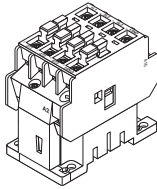

RPI Part #VPR149
OEM Part # See Chart Below

RELAY (ELECTRICAL CONTACTOR)

- Coil: 24VDC
- 3 pole; Contacts rated at 30A
- Screw terminals

Fits: Vacuum Electrical Control Box

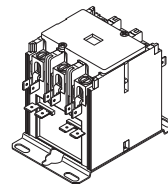

RPI Part #VPR151
OEM Part # See Chart Below

RELAY (ELECTRICAL CONTACTOR)

- Coil: 24VAC, 7 ohms
- 3 pole; Contacts rated at 40A
- 1/4" Dual Tabs

Fits: Vacuum Electrical Control Box

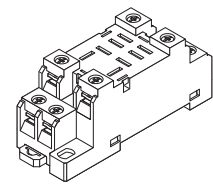

RPI Part #VPS163
OEM Part # See Chart Below

RELAY SOCKET

- Accommodates track or screw mount
- Also available: Relay (RPI Part #VPR162)

Fits: Vacuum Electrical Control Box

RPI PART #	DESCRIPTION	AIR TECHNIQUES	APOLLO/MIDMARK®	DENTALEZ®/CUSTOM AIR/RAMVAC	MATRIX/MIDMARK®	MIDMARK®	TECH WEST
VPR148	Relay (Electrical Contractor)	55857 & 55407		64568133		015-2817-00	PR-100
VPR149	Relay (Electrical Contractor)				62899901		
VPR150	Relay (Electrical Contractor)		No OEM Part # Available			015-2029-00	
VPR151	Relay (Electrical Contractor)	54498					
VPR162	Relay					015-2018-00	
VPS163	Relay Socket					015-2020-00	

NOTES: _____

DENTAL VACUUM UNITS - Air Techniques, Apollo/Midmark®, DentalEZ®/Custom Air/RamVac, Matrix/Midmark®, Midmark® & Tech West

Models: DV5, DV7, DV10, DV12, SC3, SC5, SC7, SC10, & SC12

New PM Kits to fit

**A-dec®/Dean®
Dental Compressors
and Dental Vacuum Units!**

PM Kits to fit A-dec/Dean Dental Compressors

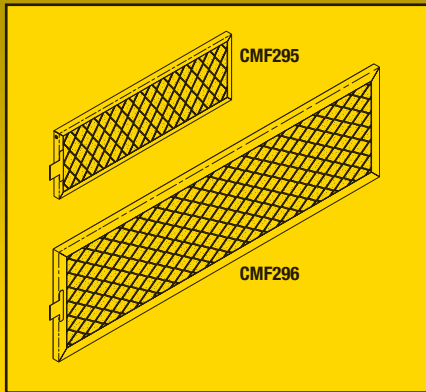

RPI Part #CMK293
OEM Part #A0050

COMPRESSOR PM KIT

- For Oil-less dual, triple and quad headed compressors
- All parts also sold separately
- Includes all parts as shown plus a PM Sticker and PM checklist
- See *the RPI Advantage* below

Fits: Compressor Body
Models: SC3, SC5 & SC7

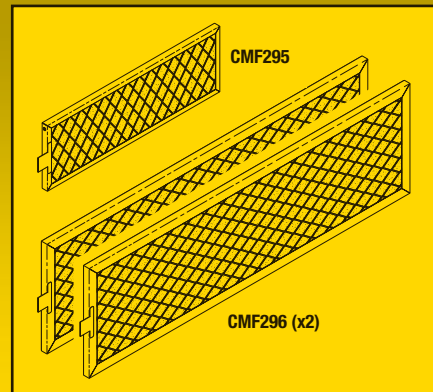

RPI Part #CMK294
OEM Part #A0150

COMPRESSOR PM KIT

- For Oil-less 5 and 6 headed compressors
- All parts also sold separately
- Includes all parts as shown plus a PM Sticker and PM checklist
- See *the RPI Advantage* below

Fits: Compressor Body
Models: SC10 & SC12

PM Kit to fit A-dec/Dean Dental Vacuum Units



RPI Part #VPK183
OEM Part #A0049

VACUUM PM KIT

- **Service Tip:** Air filter life depends on vacuum usage, nature of environment, and amount of aspirated material. Inspect air filter every 1,000 hours and replace every 2,000 hours or when visibly dirty.
- All parts also sold separately
- Includes all parts as shown plus a PM Sticker and PM checklist
- See *the RPI Advantage* below

Fits: Inside Separator Tank and Drain Assembly
Models: DV5, DV7, DV10 & DV12

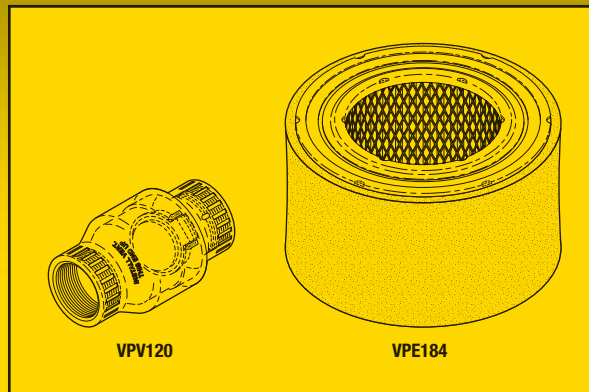

RPI Filters and PM Kits include a PM Sticker that can be attached to the compressor or vacuum unit for recording the date that the filters were replaced. It's the RPI Advantage!



replacement parts industries, inc.

CALL (800) 221-9723 • FAX (818) 882-7028 • EMAIL order@riparts.com • WEBSITE www.riparts.com

The above parts are manufactured by Replacement Parts Industries, Inc. to fit the equipment noted. All product names used in this document are trademarks or registered trademarks of their respective holders. 2010AD Show 02/21

Air Filters to fit A-dec/Dean Dental Compressors!

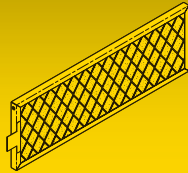

RPI Part #CMF295

OEM Part # (OEM Part # Not Available)

AIR FILTER

- Size: 9.87" lg. x 3.25" wide
- Material: 60 PPI Quadrafoam, color black, aluminum frame and stainless steel mesh
- Included in: Compressor PM Kit (RPI Part #CMK293) and Compressor PM Kit (RPI Part #CMK294)
- See *the RPI Advantage* on reverse side

Fits: Compressor Body

Models: SC3, SC5, SC7, SC10 & SC12

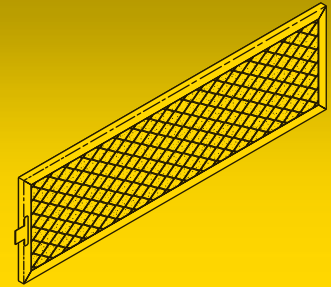

RPI Part #CMF296

OEM Part # (OEM Part # Not Available)

AIR FILTER

- Size: 18.44" lg. x 5.44" wide
- Material: 25 PPI Quadrafoam, color green, aluminum frame and stainless steel mesh
- Included in: Compressor PM Kit (RPI Part #CMK293) and Compressor PM Kit (RPI Part #CMK294)
- See *the RPI Advantage* on reverse side

Fits: Compressor Body

Models: SC3, SC5, SC7, SC10 & SC12

New Parts to fit A-dec/Dean Dental Compressors & Vacuums!

ADDRESS SERVICES REQUESTED

PERMIT NO. 2399
VAN NUYS, CA
U.S. POSTAGE PAID
PRESORTED STANDARD

625 Cochran Street • Simi Valley, California • 93065
replacement parts industries, inc.



Parts to fit A-dec/Dean Dental Vacuum Units!

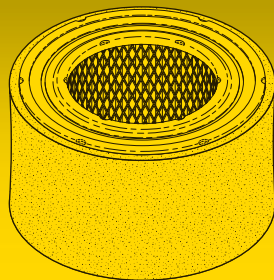

RPI Part #VPE184

OEM Part # (OEM Part # Not Available)

FILTER ELEMENT

- 5 micron
- Size 7.88" OD x 4.81" lg.
- Included in: Vacuum PM Kit (RPI Part #VPK183)
- See *the RPI Advantage* on reverse side

Fits: Inside Separator Tank

Models: DV5, DV7, DV10 & DV12

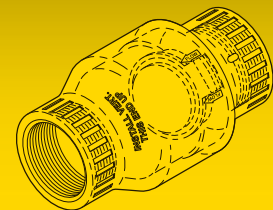

RPI Part #VPV120

OEM Part # (OEM Part # Not Available)

CHECK VALVE (1-1/2")

- Ports: 1-1/2" FPT
- Material: Clear PVC
- Size: 3.38" dia. x 5.75" lg.
- Included in: Vacuum PM Kit (RPI Part #VPK183)

Fits: Inside Separator Tank and Drain Assembly

Models: DV5, DV7, DV10 & DV12

DentalEZ®/Custom Air/RamVac, MatrX Medical, MatrX/Midmark® & Midmark®



PM Kits and More to fit DENTAL VACUUM UNITS!



RPI Part #VPK185
OEM Part #77000796
(Filter Element) &
77007063 (Purge Muffler)



VACUUM PM KIT

- For single headed vacuum systems
- Includes: (1 pkg) Filter Element (RPI Part #VPE188), Purge Muffler (RPI Part #VPM190), PM sticker, and PM checklist
- Also available: Filter Cap (RPI Part #VPC189)

Fits: Vacuum Pump

Models: *Midmark:* PM-1;
Matrx Medical • MatrX/Midmark: PM-75



RPI Part #VPK187
OEM Part #77000796
(Filter Element) &
77007063 (Purge Muffler)



VACUUM PM KIT

- For triple headed vacuum systems
- Includes: (3 pkgs) Filter Element (RPI Part #VPE188), (3) Purge Muffler (RPI Part #VPM190), PM sticker, and PM checklist
- Also available: Filter Cap (RPI Part #VPC189)

Fits: Vacuum Pump

Models: *Midmark:* PM-4;
Matrx Medical • MatrX/Midmark: PM-75-3



RPI Part #VPK186
OEM Part #77000796
(Filter Element) &
77007063 (Purge Muffler)



VACUUM PM KIT

- For dual headed vacuum systems
- Includes: (2 pkgs) Filter Element (RPI Part #VPE188), (2) Purge Muffler (RPI Part #VPM190), PM sticker, and PM checklist
- Also available: Filter Cap (RPI Part #VPC189)

Fits: Vacuum Pump

Models: *Midmark:* PM-3;
Matrx Medical • MatrX/Midmark: PM-75-2



RPI Part #VPE188
OEM Part #77000796



FILTER ELEMENT

- 2 per package
- Size: 1.25" OD x 2.19" lg.
- Felt elements
- Includes: (2) Filters, (2 pcs) O-Ring (RPI Part #RX0086) and PM sticker
- Also available: Filter Cap (RPI Part #VPC189)
- See **Note** below for quantity required for each model

Fits: Vacuum Pump

Models: *Midmark:* PM-1, PM-3 & PM-4;
Matrx Medical • MatrX/Midmark: PM-75, PM-75-2 & PM-75-3



RPI Part #VPM190
OEM Part #77007063



PURGE MUFFLER

- Port Size: 3/8" MPT
- Size: 11/16" hex x 1-1/2" lg.
- Material: 40 micron sintered bronze

Fits: Vacuum Pump

Models: *Midmark:* PM-1, PM-3 & PM-4;
Matrx Medical • MatrX/Midmark: PM-75,
PM-75-2 & PM-75-3



RPI Part #RX0086
OEM Part #7700789



O-RING

- 2 per package
- Size: 1.362" ID x 1.568" OD x .103" C/S
- Material: Nitrile (Buna-N); Duro 70

Fits: Vacuum Pump

Models: *Midmark:* PM-1, PM-3 & PM-4;
Matrx Medical • MatrX/Midmark: PM-75,
PM-75-2 & PM-75-3



RPI Part #VPC189
OEM Part #77000788



FILTER CAP

- 2 per package
- Also available: O-Ring (RPI Part #RX0086)
- See **Notes** below for quantity required for each model
- Holds Filter Element (RPI Part #VPE188)

Fits: Vacuum Pump

Models: *Midmark:* PM-1, PM-3 & PM-4;
Matrx Medical • MatrX/Midmark: PM-75,
PM-75-2 & PM-75-3

Note: *Midmark:* PM-1 requires 1 package, PM-3 requires 2 packages, PM-4 requires 3 packages;
Matrx/Midmark: PM-75 requires 1 package, PM-75-2 requires 2 packages, and PM-75-3 requires 3 packages.



replacement parts industries, inc. A Healthcare Components Group Company
CALL (800) 221-9723 • FAX (818) 882-7028 • EMAIL order@rpiparts.com • WEBSITE www.rpiparts.com

The above parts are manufactured by Replacement Parts Industries, Inc. to fit the equipment noted. All product names used in this document are trademarks or registered trademarks of their respective holders. 2007VP Show 03/22



RPI Part #VPK192
OEM Part # (No OEM Part # Available)

VACUUM PM KIT

- Includes: Oil Filter Media Kit (RPI Part #VPK193), Muffler (RPI Part #VPM194), Instant Gasket Sealant (RPI Part #RXS087), (3) Synthetic Oil (Mobil 1®) (RPI Part #VPL131), (1 pkg) Disposal Bag (RPI Part #RPB838), (1 pkg) Absorbent Pad (RPI Part #RPP958), and PM sticker
- Also available: Grommet (RPI Part #VPG205)

Fits: Oil Reservoir
Models: *DentalEZ/Custom Air/RamVac:* Bulldog 550, Bulldog QT1, Bulldog QT2 & Bulldog QT3



RPI Part #VPK196
OEM Part # (No OEM Part # Available)

VACUUM PM KIT

- Includes: Oil Filter Media Kit (RPI Part #VPK197), Muffler (RPI Part #VPM198), Instant Gasket Sealant (RPI Part #RXS087), (5) Synthetic Oil (Mobil 1®) (RPI Part #VPL131), (1 pkg) Disposal Bag (RPI Part #RPB838), (1 pkg) Absorbent Pad (RPI Part #RPP958), and PM Sticker
- Also available: Grommet (RPI Part #VPG205), Float Switch (Low Oil) (RPI Part #VPS201), and Float Switch (Water In Oil) (RPI Part #VPS202)

Fits: Oil Reservoir
Models: *DentalEZ/Custom Air/RamVac:* Bison 3 & Bison 5

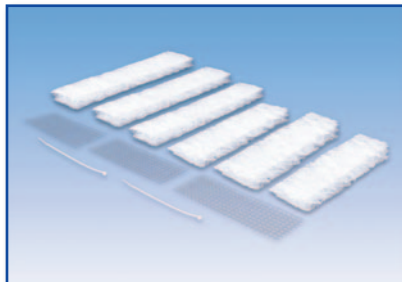

RPI Part #VPK193
OEM Part #003727SP

OIL FILTER MEDIA KIT

- Includes: Filter media, galvanized mesh, (2 pcs) Cable Tie (RPI Part #RPT661), and PM sticker
- Included in: PM Kit (RPI Part #VPK192)

Fits: Lid Assembly
Models: *DentalEZ/Custom Air/RamVac:* Bulldog 550, Bulldog QT1, Bulldog QT2 & Bulldog QT3

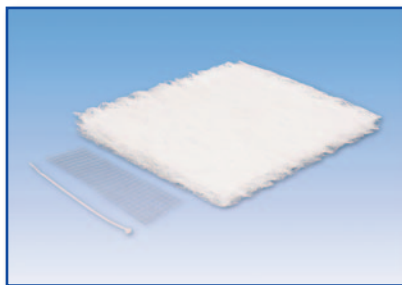

RPI Part #VPK197
OEM Part #003729SP

OIL FILTER MEDIA KIT

- Includes: Filter media, galvanized mesh, (1 pc) Cable Tie (RPI Part #RPT661), and PM sticker
- Included in: PM Kit (RPI Part #VPK196) and PM Kit (RPI Part #VPK200)

Fits: Lid, Oil Reservoir Assembly
Models: *DentalEZ/Custom Air/RamVac:* Bison 3, Bison 5, Bison 7 & Bison 9



RPI Part #VPM198
OEM Part #003684SP

MUFFLER

- Material: Zinc plated steel case, stainless steel screen mesh
- Port Size: 2" MPT; Size: 2-3/8" hex x 5-19/32" lg.
- Includes: Mounting screw
- Included in: PM Kit (RPI Part #'s VPK196 & VPK200)

Fits: Reservoir
Models: *DentalEZ/Custom Air/RamVac:* Bison 3, Bison 5, Bison 7 & Bison 9



RPI Part #VPM194
OEM Part #003682SP

MUFFLER

- Material: Zinc plated steel case, stainless steel screen mesh
- Port Size: 1-1/2" MPT; Size: 2.00" hex x 4-15/16" lg.
- Includes: Mounting screw
- Included in: PM Kit (RPI Part #VPK192)

Fits: Reservoir
Models: *DentalEZ/Custom Air/RamVac:* Bulldog 550, Bulldog QT1, Bulldog QT2 & Bulldog QT3



RPI Part #RPB838
OEM Part # (No OEM Part # Available)

DISPOSAL BAG

- 3 per package
 - Used oil collection and disposal bag
- Models:** *DentalEZ/Custom Air/RamVac:* Bulldog 550, Bulldog QT1, Bulldog QT2, Bulldog QT3, Bison 3, Bison 5, Bison 7 & Bison 9



RPI Part #VPK200
OEM Part # (No OEM Part # Available)

VACUUM PM KIT

- Includes: Oil Filter Media Kit (RPI Part #VPK197), (2) Muffler (RPI Part #VPM198), Instant Gasket Sealant (RPI Part #RXS087), (5) Synthetic Oil (Mobil 1®) (RPI Part #VPL131), (1 pkg) Disposal Bag (RPI Part #RPB838), (1 pkg) Absorbent Pad (RPI Part #RPP958), and PM Sticker
- Also available: Grommet (RPI Part #VPG205), Float Switch (Low Oil) (RPI Part #VPS201), and Float Switch (Water In Oil) (RPI Part #VPS202)

Fits: Oil Reservoir
Models: *DentalEZ/Custom Air/RamVac:* Bison 7 & Bison 9

RPI Part #RXS087
OEM Part # (No OEM Part # Available)
Industry Part #Loctite 40478



INSTANT GASKET SEALANT

- 3.04 fl. oz. (90ml) aerosol can
- Material: Black silicone; Temperature range: -65° to 450°F
- Included in: PM Kit (RPI Part #'s VPK192, VPK196 & VPK200)

Fits: Oil Reservoir Lid Assembly
Models: *DentalEZ/Custom Air/RamVac:* Bulldog 550, Bulldog QT1, Bulldog QT2, Bulldog QT3, Bison 3, Bison 5, Bison 7 & Bison 9



RPI Part #VPL131
OEM Part # (No OEM Part # Available)

SYNTHETIC OIL (MOBIL 1®)

- Size: 1 Quart (.946 Liter) bottle
- 15W-50 (ISO grade 32)
- Also available: Synthetic Oil (Mobil 1®) (Case of 6) (RPI Part #VPL132)

Fits: Vacuum Unit
Models: *DentalEZ/Custom Air/RamVac:* Bulldog 550, Bulldog QT1, Bulldog QT2, Bulldog QT3, Bison 3, Bison 5, Bison 7 & Bison 9



RPI Part #RPP958
OEM Part # (No OEM Part # Available)

ABSORBENT PAD

- 3 per package; Size: 9-1/4" x 14-1/2"
- Can be used for oil drip collection and spills

Models: *DentalEZ/Custom Air/RamVac:* Bulldog 550, Bulldog QT1, Bulldog QT2, Bulldog QT3, Bison 3, Bison 5, Bison 7 & Bison 9

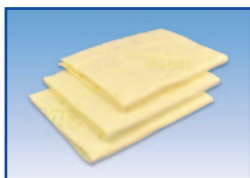

RPI Part #VPG205
OEM Part #000473

GROMMET

- 1-5/8" OD x 7/8" ID x 7/16" Thk.
- 1-1/4" dia. x .062" Panel Cutout
- Material: Nitrile (Buna-N)

Fits: Reservoir Tank/Moisture Alarm assemblies
Models: *DentalEZ/Custom Air/RamVac:* Bison 3, Bison 5, Bison 7 & Bison 9



RPI Part #VPS201
OEM Part #005093

FLOAT SWITCH (LOW OIL)

- Ports: 1/8" MPT; 36" Leads
- Vertical mount, N.C.
- Also available: Float Switch (Water In Oil) (RPI Part #VPS202), Pipe Sealant 567 (RPI Part #RPA459), Butt Connector (RPI Part #RPT011), Instant Gasket Sealant (RPI Part #RXS087), Disposal Bag (RPI Part #RPB838), Absorbent Pad (RPI Part #RPP958) and Synthetic Oil (Mobil 1®) (RPI Part #VPL131)

Fits: Oil Reservoir
Models: *DentalEZ/Custom Air/RamVac:* Bison 3, Bison 5, Bison 7 & Bison 9



RPI Part #VPS202
OEM Part #005094

FLOAT SWITCH (WATER IN OIL)

- Ports: 1/8" MPT; 36" Leads
- Vertical mount, N.O.
- Also available: Float Switch (Low Oil) (RPI Part #VPS201), Pipe Sealant 567 (RPI Part #RPA459), Butt Connector (RPI Part #RPT011), Instant Gasket Sealant (RPI Part #RXS087), Disposal Bag (RPI Part #RPB838), Absorbent Pad (RPI Part #RPP958) and Synthetic Oil (Mobil 1®) (RPI Part #VPL131)

Fits: Oil Reservoir
Models: *DentalEZ/Custom Air/RamVac:* Bison 3, Bison 5, Bison 7 & Bison 9

NEW PM KITS AND MORE FOR DENTAL VACUUM UNITS!

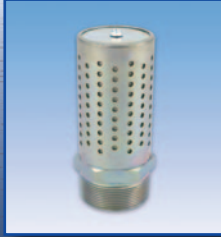

NEW PM KITS AND MORE TO FIT DENTAL VACUUM UNITS!

ADDRESS SERVICES REQUESTED

RESORTED STANDARD
U.S. POSTAGE PAID
VAN NUYS, CA
PERMIT NO. 2399

replacement parts industries, inc.
625 Cochran Street • Simi Valley, California • 93065

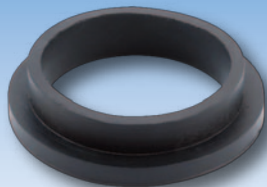

RPI Part #VPG195
OEM Part #000505

SPUD GASKET

- 2" round gasket
- Material: Black rubber
- Also available: Filter Kit (RPI Part #VPK113), Filter Kit (RPI Part #VPK117), Filter Element (RPI Part #VPE114), Filter Element (RPI Part #VPE115), and Filter Element (RPI Part #VPE118)

Fits: Vacuum Controller Assembly

Models: *DentalEZ/Custom Air/RamVac:* Bulldog 550, Bulldog QT1, Bulldog QT2, Bulldog QT3, Bison 3, Bison 5, Bison 7 & Bison 9



RPI Part #VPS191
OEM Part #30126601

VACUUM SWITCH

- 115/230VAC
- Contacts: N.C. DPST
- Factory set to: On @ 13"Hg. - Off @ 20"Hg.
- 1/4-18 NPSF Input Port - 3 Knock-outs for 1/2" NPT Conduit
- Also available: Pipe Sealant 567 (RPI Part #RPA459)

Fits: Vacuum Pump

Models: *Midmark:* PM-1, PM-3 & PM-4;

Matrx Medical • Matrx/Midmark: PM-75, PM-75-2 & PM-75-3

DentalEZ®/Custom Air/RamVac, MatrX Medical, MatrX/Midmark® & Midmark®



NEW MOISTURE ALARM ASSEMBLIES, PM KITS & MORE TO FIT DENTAL VACCUUM UNITS!

RPI Part #VPK185
OEM Part #77000796 (Filter Element) &
77007063 (Purge Muffler)

VACUUM PM KIT

- For single headed vacuum systems
- Includes: (1 pkg) Filter Element (RPI Part #VPE188), Purge Muffler (RPI Part #VPM190), PM sticker, and PM checklist

Fits: Vacuum Pump

Models: *Midmark:* PM-1;

Matrx Medical • MatrX/Midmark: PM-75



RPI Part #VPK186
OEM Part #77000796 (Filter Element) &
77007063 (Purge Muffler)

VACUUM PM KIT

- For dual headed vacuum systems
- Includes: (2 pkgs) Filter Element (RPI Part #VPE188), (2) Purge Muffler (RPI Part #VPM190), PM sticker, and PM checklist

Fits: Vacuum Pump

Models: *Midmark:* PM-3;

Matrx Medical • MatrX/Midmark: PM-75-2



RPI Part #VPK187
OEM Part #77000796 (Filter Element) &
77007063 (Purge Muffler)

VACUUM PM KIT

- For triple headed vacuum systems
- Includes: (3 pkgs) Filter Element (RPI Part #VPE188), (3) Purge Muffler (RPI Part #VPM190), PM sticker, and PM checklist

Fits: Vacuum Pump

Models: *Midmark:* PM-4;

Matrx Medical • MatrX/Midmark: PM-75-3



RPI Part #VPE188
OEM Part #77000796

FILTER ELEMENT

- 2 per package
- Size: 1.25" OD x 2.19" lg.; Felt elements
- Includes: (2) Filters, (1 pkg) O-Ring (RPI Part #RX0086) and PM sticker
- See **Note Regarding Quantities Required** for each model to the right

Fits: Vacuum Pump

Models: *Midmark:* PM-1, PM-3 & PM-4;

Matrx Medical • MatrX/Midmark: PM-75, PM-75-2 & PM-75-3



Also Available ...

RPI Part #VPC189
OEM Part #77000788

FILTER CAP

- 2 per package
 - Also available: O-Ring (RPI Part #RX0086)
 - See **Note Regarding Quantities Required** for each model below
 - Holds Filter Element (RPI Part #VPE188)
- Fits:** Vacuum Pump
- Models:** *Midmark:* PM-1, PM-3 & PM-4;
Matrx Medical • MatrX/Midmark: PM-75, PM-75-2 & PM-75-3



x2

RPI Part #RX0086
OEM Part #7700789

O-RING

- 2 per package
 - Size: 1.362" ID x 1.568" OD x .103" C/S
 - Material: Nitrile (Buna-N); Duro 70
 - See **Note Regarding Quantities Required** for each model below
- Fits:** Vacuum Pump
- Models:** *Midmark:* PM-1, PM-3 & PM-4;
Matrx Medical • MatrX/Midmark: PM-75, PM-75-2 & PM-75-3



x2

RPI Part #VPM190
OEM Part #77007063

PURGE MUFFLER

- Port Size: 3/8" MPT
- Size: 11/16" hex x 1-1/2" lg.
- Material: 40 micron sintered bronze
- See **Note Regarding Quantities Required** for each model below

Fits: Vacuum Pump

Models: *Midmark:* PM-1, PM-3 & PM-4;

Matrx Medical • MatrX/Midmark: PM-75, PM-75-2 & PM-75-3



Note Regarding Quantities Required

OEM	Model	Quantity Required
Midmark	PM-1	1 package
Midmark	PM-3	2 packages
Midmark	PM-4	3 packages
Matrx/Midmark	PM-75	1 package
Matrx/Midmark	PM-75-2	2 packages
Matrx/Midmark	PM-75-3	3 packages



replacement parts industries, inc. A Healthcare Components Group Company
 CALL (800) 221-9723 • FAX (818) 882-7028 • EMAIL order@rpiparts.com • WEBSITE www.rpiparts.com

The above parts are manufactured by Replacement Parts Industries, Inc. to fit the equipment noted. All product names used in this document are trademarks or registered trademarks of their respective holders. 2007VP RD2 Show 05/22



RPI Part #VPK192
OEM Part # (No OEM Part # Available)

VACUUM PM KIT

- Includes: Oil Filter Media Kit (RPI Part #VPK193), Muffler (RPI Part #VPM194), Instant Gasket Sealant (RPI Part #RXS087), (3) Synthetic Oil (Mobil 1®) (RPI Part #VPL131), (1 pkg) Disposal Bag (RPI Part #RPB838), (1 pkg) Absorbent Pad (RPI Part #RPP958), and PM sticker
- Also available: Grommet (RPI Part #VPG205) and Moisture Alarm Assembly (RPI Part #VPA203)

Fits: Oil Reservoir
Models: *DentalEZ/Custom Air/RamVac:* Bulldog 550, Bulldog QT1, Bulldog QT2 & Bulldog QT3



RPI Part #VPK196
OEM Part # (No OEM Part # Available)

VACUUM PM KIT

- Includes: Oil Filter Media Kit (RPI Part #VPK197), Muffler (RPI Part #VPM198), Instant Gasket Sealant (RPI Part #RXS087), (5) Synthetic Oil (Mobil 1®) (RPI Part #VPL131), (1 pkg) Disposal Bag (RPI Part #RPB838), (1 pkg) Absorbent Pad (RPI Part #RPP958), and PM Sticker
- Also available: Grommet (RPI Part #VPG205), Moisture Alarm Assembly (RPI Part #VPA204), Float Switch (Low Oil) (RPI Part #VPS201), and Float Switch (Water In Oil) (RPI Part #VPS202)

Fits: Oil Reservoir
Models: *DentalEZ/Custom Air/RamVac:* Bison 3 & Bison 5

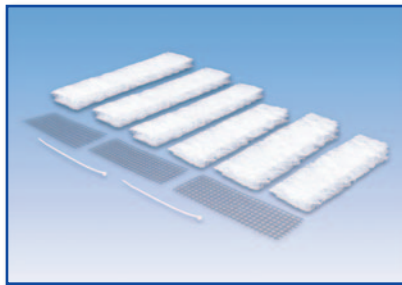

RPI Part #VPK193
OEM Part #003727SP

OIL FILTER MEDIA KIT

- Includes: Filter media, galvanized mesh, (2 pcs) Cable Tie (RPI Part #RPT661), and PM sticker
- Included in: PM Kit (RPI Part #VPK192)

Fits: Lid Assembly
Models: *DentalEZ/Custom Air/RamVac:* Bulldog 550, Bulldog QT1, Bulldog QT2 & Bulldog QT3

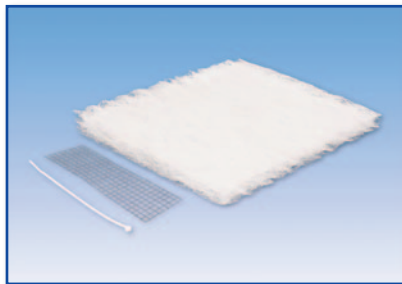

RPI Part #VPK197
OEM Part #003729SP

OIL FILTER MEDIA KIT

- Includes: Filter media, galvanized mesh, (1 pc) Cable Tie (RPI Part #RPT661), and PM sticker
- Included in: PM Kit (RPI Part #VPK196) and PM Kit (RPI Part #VPK200)

Fits: Lid, Oil Reservoir Assembly
Models: *DentalEZ/Custom Air/RamVac:* Bison 3, Bison 5, Bison 7 & Bison 9

RPI Part #VPM198
OEM Part #003684SP

MUFFLER

- Material: Zinc plated steel case, stainless steel screen mesh
- Port Size: 2" MPT; Size: 2-3/8" hex x 5-19/32" lg.
- Includes: Mounting screw
- Included in: PM Kit (RPI Part #'s VPK196 & VPK200)

Fits: Reservoir
Models: *DentalEZ/Custom Air/RamVac:* Bison 3, Bison 5, Bison 7 & Bison 9



RPI Part #VPM194
OEM Part #003682SP

MUFFLER

- Material: Zinc plated steel case, stainless steel screen mesh
- Port Size: 1-1/2" MPT; Size: 2.00" hex x 4-15/16" lg.
- Includes: Mounting screw
- Included in: PM Kit (RPI Part #VPK192)

Fits: Reservoir
Models: *DentalEZ/Custom Air/RamVac:* Bulldog 550, Bulldog QT1, Bulldog QT2 & Bulldog QT3



RPI Part #RPB838
OEM Part # (No OEM Part # Available)

DISPOSAL BAG

- 3 per package
 - Used oil collection and disposal bag
- Models:** *DentalEZ/Custom Air/RamVac:* Bulldog 550, Bulldog QT1, Bulldog QT2, Bulldog QT3, Bison 3, Bison 5, Bison 7 & Bison 9





RPI Part #VPK200
OEM Part # (No OEM Part # Available)

VACUUM PM KIT

- Includes: Oil Filter Media Kit (RPI Part #VPK197), (2) Muffler (RPI Part #VPM198), Instant Gasket Sealant (RPI Part #RXS087), (5) Synthetic Oil (Mobil 1®) (RPI Part #VPL131), (1 pkg) Disposal Bag (RPI Part #RPB838), (1 pkg) Absorbent Pad (RPI Part #RPP958), and PM Sticker
- Also available: Grommet (RPI Part #VPG205), Moisture Alarm Assembly (RPI Part #VPA204), Float Switch (Low Oil) (RPI Part #VPS201), and Float Switch (Water In Oil) (RPI Part #VPS202)

Fits: Oil Reservoir
Models: *DentalEZ/Custom Air/RamVac:* Bison 7 & Bison 9

RPI Part #RXS087
OEM Part # (No OEM Part # Available)
Industry Part #Loctite 40478

INSTANT GASKET SEALANT

- 3.04 fl. oz. (90ml) aerosol can
- Material: Black silicone; Temperature range: -65° to 450°F
- Included in: PM Kit (RPI Part #'s VPK192, VPK196 & VPK200)

Fits: Oil Reservoir Lid Assembly
Models: *DentalEZ/Custom Air/RamVac:* Bulldog 550, Bulldog QT1, Bulldog QT2, Bulldog QT3, Bison 3, Bison 5, Bison 7 & Bison 9



RPI Part #VPL131
OEM Part # (No OEM Part # Available)

SYNTHETIC OIL (MOBIL 1®)

- Size: 1 Quart (.946 Liter) bottle
- 15W-50 (ISO grade 32)
- Also available: Synthetic Oil (Mobil 1®) (Case of 6) (RPI Part #VPL132)

Fits: Vacuum Unit
Models: *DentalEZ/Custom Air/RamVac:* Bulldog 550, Bulldog QT1, Bulldog QT2, Bulldog QT3, Bison 3, Bison 5, Bison 7 & Bison 9



RPI Part #RPP958
OEM Part # (No OEM Part # Available)

ABSORBENT PAD

- 3 per package; Size: 9-1/4" x 14-1/2"
- Can be used for oil drip collection and spills

Models: *DentalEZ/Custom Air/RamVac:* Bulldog 550, Bulldog QT1, Bulldog QT2, Bulldog QT3, Bison 3, Bison 5, Bison 7 & Bison 9

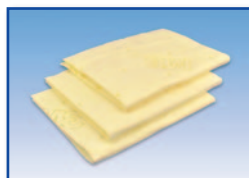

RPI Part #VPA203
OEM Part #002854

MOISTURE ALARM ASSEMBLY

- Material: Urethane housing; 23-1/4" lg. cable
- Includes: Grommet (RPI Part #VPG205)

Fits: Vacuum Controller Enclosure
Models: *DentalEZ/Custom Air/RamVac:* Bulldog 550, Bulldog QT1, Bulldog QT2 & Bulldog QT3



RPI Part #VPA204
OEM Part #002855

MOISTURE ALARM ASSEMBLY

- Material: Urethane housing; 14-1/4" lg. cable
- Includes: Grommet (RPI Part #VPG205)

Fits: Vacuum Controller Enclosure
Models: *DentalEZ/Custom Air/RamVac:* Bison 3, Bison 5, Bison 7 & Bison 9



RPI Part #VPG205
OEM Part #000473

GROMMET

- Size: 1-5/8" OD x 7/8" ID x 7/16" Thk.
- Panel Cutout: 1-1/4" dia. x .062" Thk.
- Material: Nitrile (Buna-N)
- Included in: Moisture Alarm Assembly (RPI Part #VPA203) and Moisture Alarm Assembly (RPI Part #VPA204)

Fits: Reservoir Tank/Moisture Alarm assemblies
Models: *DentalEZ/Custom Air/RamVac:* Bison 3, Bison 5, Bison 7, Bison 9, Bulldog 550, Bulldog QT1, Bulldog QT2 & Bulldog QT3



RPI Part #VPS201
OEM Part #005093

FLOAT SWITCH (LOW OIL)

- Ports: 1/8" MPT; 36" Leads
- Vertical mount, N.C.

Fits: Oil Reservoir
Models: *DentalEZ/Custom Air/RamVac:* Bison 3, Bison 5, Bison 7 & Bison 9



RPI Part #VPS202
OEM Part #005094

FLOAT SWITCH (WATER IN OIL)

- Ports: 1/8" MPT; 36" Leads
- Vertical mount, N.O.

Fits: Oil Reservoir
Models: *DentalEZ/Custom Air/RamVac:* Bison 3, Bison 5, Bison 7 & Bison 9



NEW MOISTURE ALARM ASSEMBLIES TO FIT DENTAL VACUUM UNITS!



RPI Part #VPA203
OEM Part #002854

MOISTURE ALARM ASSEMBLY

- Material: Urethane housing; 23-1/4" lg. cable
- Includes: Grommet (RPI Part #VPG205)

Fits: Vacuum Controller Enclosure

Models: DentalEZ/Custom Air/RamVac: Bulldog 550, Bulldog QT1, Bulldog QT2 & Bulldog QT3



RPI Part #VPA204
OEM Part #002855

MOISTURE ALARM ASSEMBLY

- Material: Urethane housing; 14-1/4" lg. cable
- Includes: Grommet (RPI Part #VPG205)

Fits: Vacuum Controller Enclosure

Models: DentalEZ/Custom Air/RamVac: Bison 3, Bison 5, Bison 7 & Bison 9

NEW PM KITS AND MORE TO FIT DENTAL VACUUM UNITS!

ADDRESS SERVICES REQUESTED

PERMIT NO. 2399
VAN NUYS, CA
U.S. POSTAGE PAID
PRESORTED STANDARD

replacement parts industries, inc.
625 Cochran Street • Simi Valley, California • 93065

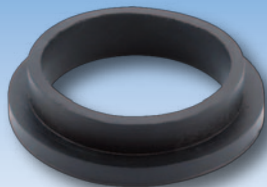

RPI Part #VPG195
OEM Part #000505

SPUD GASKET

- 2" round gasket
- Material: Black rubber
- Also available: Filter Kit (RPI Part #VPK113), Filter Kit (RPI Part #VPK117), Filter Element (RPI Part #VPE114), Filter Element (RPI Part #VPE115), and Filter Element (RPI Part #VPE118)

Fits: Vacuum Controller Assembly

Models: DentalEZ/Custom Air/RamVac: Bison 3, Bison 5, Bison 7, Bison 9, Bulldog 550, Bulldog QT1, Bulldog QT2 & Bulldog QT3



RPI Part #VPS191
OEM Part #30126601

VACUUM SWITCH





- 115/230VAC
- Contacts: N.C. DPST
- Factory set to: On @ 13"Hg. - Off @ 20"Hg.
- 1/4-18 NPSF Input Port - 3 Knock-outs for 1/2" NPT Conduit
- Also available: Pipe Sealant 567 (RPI Part #RPA459)

Fits: Vacuum Pump



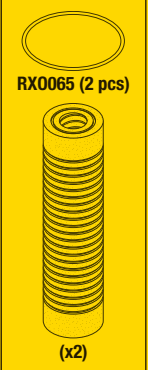

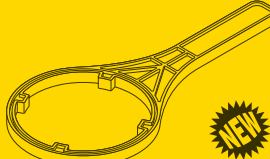
Models: Midmark: PM-1, PM-3 & PM-4;

Matrx Medical • Matrx/Midmark: PM-75, PM-75-2 & PM-75-3



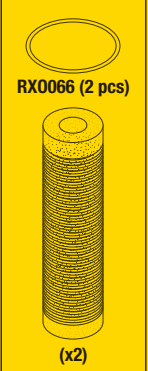

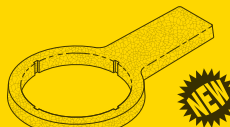
New Parts For Utility Room Water Control Systems!

<p>RPI Part #WCE003 OEM Part #53035; PFM85240; 77000300; WFE-750</p> <p>FILTER ELEMENT (5 MICRON)</p> <ul style="list-style-type: none"> • 2 per package • Size: 2.50" OD x 9.88" lg. • Includes all parts as shown and PM Stickers • Recommended annual replacement for the Filter Element <p>Fits: 3/4" Filter Housing Assembly Models: See <i>Models</i> below</p>	<p></p> <p></p> <p>RX0065 (2 pcs)</p> <p>(x2)</p>	<p>RPI Part #RX0065 OEM Part #53106; MRP70950; 77007010</p> <p>O-RING</p> <ul style="list-style-type: none"> • 2 per package • Size: 3.859" ID x 4.137" OD x .139" C/S • Material: Nitrile (Buna-N), 70 Duro <p>Fits: 3/4" Filter Housing Assembly Models: See <i>Models</i> below</p>	<p></p> <p>RPI Part #WCT007 OEM Part #MMS71173; 7700069</p> <p>SPANNER WRENCH</p> <ul style="list-style-type: none"> • Wrench for 4.83" OD bowl <p>Fits: 4.83" ID Filter Housing Assembly Models: See <i>Models</i> below</p> <p></p> <p></p>
--	---	--	--

Models: Air Techniques: 53020 & 53020-1; Apollo/Midmark: ASAHWFB34, ASAHWFB34B, ASAHWFB34C, ASAWCFB34, ASAWCFB34B, ASAWCFB34C, ASAWFB34, ASAWFB34B & ASAWFB34C; Matrx Medical: FBR-34R; Midmark: 77002146; Tech West: WB-750, WB-750-RC, WBF-750 & WBF-750-RC

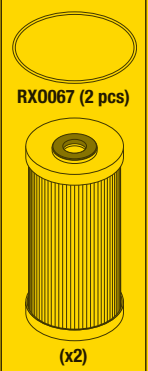
<p>RPI Part #WCE004 OEM Part #64520006</p> <p>FILTER ELEMENT (5 MICRON)</p> <ul style="list-style-type: none"> • 2 per package • Size: 2.50" OD x 9.88" lg. • Includes all parts as shown and PM Stickers • Recommended annual replacement for the Filter Element <p>Fits: 3/4" Filter Housing Assembly Models: See <i>Models</i> below</p>	<p></p> <p></p> <p>RX0066 (2 pcs)</p> <p>(x2)</p>	<p>RPI Part #RX0066 OEM Part # (No OEM Number Available)</p> <p>O-RING</p> <ul style="list-style-type: none"> • 2 per package • Size: 3.484" ID x 3.762" OD x .139" C/S • Material: Nitrile (Buna-N), 70 Duro <p>Fits: 3/4" Filter Housing Assembly Models: See <i>Models</i> below</p>	<p></p> <p>RPI Part #WCT008 OEM Part # (No OEM Number Available)</p> <p>SPANNER WRENCH</p> <ul style="list-style-type: none"> • Wrench for 3.86" OD bowl <p>Fits: 3.86" ID Filter Housing Assembly Models: See <i>Models</i> below</p> <p></p> <p></p>
--	--	---	---

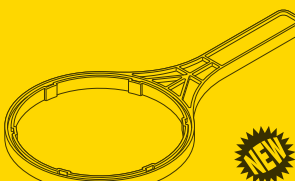
Models: DentalEZ/Custom Air/Ramvac: WC110, WC210 & WC230

<p>RPI Part #WCE010 OEM Part # 53153; PFM85241; 77000473; 64520012; WPE-100</p> <p>FILTER ELEMENT (5 MICRON)</p> <ul style="list-style-type: none"> • 2 per package • Size: 4.50" OD x 9.75" lg. • Includes all parts as shown and PM Stickers • Recommended annual replacement for the Filter Element <p>Fits: 1", 1-1/4", and 1-1/2" Filter Housing Assembly Models: See <i>Models</i> below</p>	<p></p> <p></p> <p>RX0067 (2 pcs)</p> <p>(x2)</p>	<p>RPI Part #RX0067 OEM Part #53172-1; MRP70951; 65977200; 64553032</p> <p>O-RING</p> <ul style="list-style-type: none"> • 2 per package • Size: 5.510" ID x 5.850" OD x .170" C/S • Material: Nitrile (Buna-N), 70 Duro <p>Fits: 1", 1-1/4", and 1-1/2" Filter Housing Assembly Models: See <i>Models</i> below</p>	<p></p> <p>RPI Part #WCT012 OEM Part #77000063</p> <p>SPANNER WRENCH</p> <ul style="list-style-type: none"> • Wrench for 6.05" OD bowl <p>Fits: 6.05" ID Filter Housing Assembly Models: See <i>Models</i> below</p> <p></p> <p></p>
---	---	--	---

Models: Air Techniques: 53170 & 53171; Apollo/Midmark®: ASAWFB100, ASAWFB100B, ASAWFB100C, ASAWFB125, ASAWFB125C, ASAWFB150 & ASAWFB125C; DentalEZ: WC-300, WC-310, WC-400 & WC-410; Matrx Medical: FBP-100R, FBP-125R & FBP-150R; Midmark®: 77002147, 77002148 & 77002149; Tech West: WBF-100 & WBF-100-RC;



RPI Parts for ... Dental Utility Room Water Control Systems!

- Air Techniques
- Apollo/Midmark®
- DentalEZ/Custom Air/Ramvac
- Matrx/Midmark®
- Midmark®
- Tech West

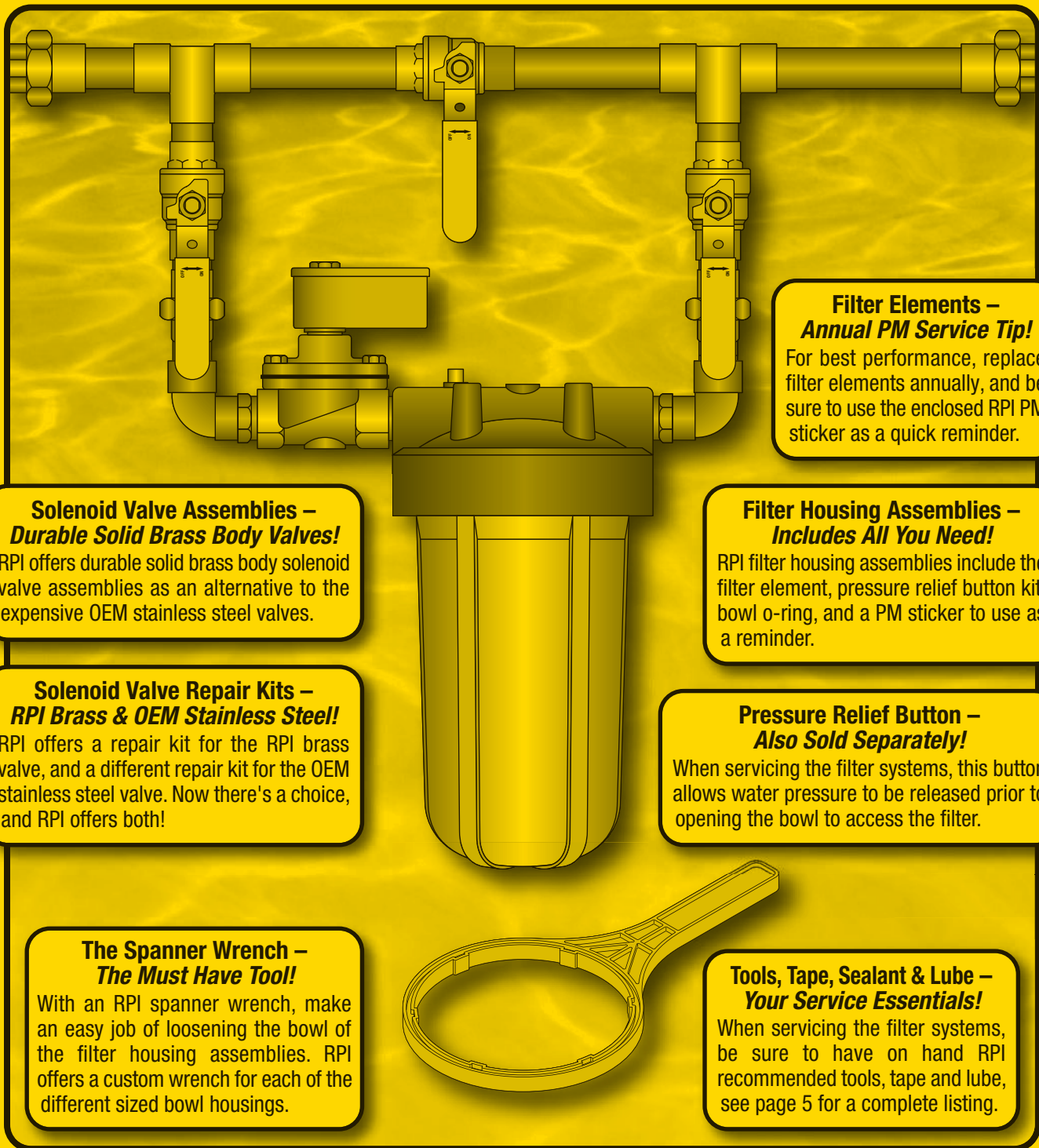

Solenoid Valve Assemblies – Durable Solid Brass Body Valves!
RPI offers durable solid brass body solenoid valve assemblies as an alternative to the expensive OEM stainless steel valves.

Solenoid Valve Repair Kits – RPI Brass & OEM Stainless Steel!
RPI offers a repair kit for the RPI brass valve, and a different repair kit for the OEM stainless steel valve. Now there's a choice, and RPI offers both!

The Spanner Wrench – The Must Have Tool!
With an RPI spanner wrench, make an easy job of loosening the bowl of the filter housing assemblies. RPI offers a custom wrench for each of the different sized bowl housings.

Filter Elements – Annual PM Service Tip!
For best performance, replace filter elements annually, and be sure to use the enclosed RPI PM sticker as a quick reminder.

Filter Housing Assemblies – Includes All You Need!
RPI filter housing assemblies include the filter element, pressure relief button kit, bowl o-ring, and a PM sticker to use as a reminder.

Pressure Relief Button – Also Sold Separately!
When servicing the filter systems, this button allows water pressure to be released prior to opening the bowl to access the filter.

Tools, Tape, Sealant & Lube – Your Service Essentials!
When servicing the filter systems, be sure to have on hand RPI recommended tools, tape and lube, see page 5 for a complete listing.

DENTAL WATER CONTROLS – Air Techniques, Apollo/Midmark®, DentalEZ/Custom Air/Ramvac, Matrx/Midmark®, Midmark®, & Tech West



replacement parts industries, inc.

CALL (800) 221-9723 • FAX (818) 882-7028 • EMAIL order@rpiparts.com • WEBSITE www.rpiparts.com

The above parts are manufactured by Replacement Parts Industries, Inc. to fit the equipment noted. All product names used in this document are trademarks or registered trademarks of their respective holders. 1905WC SHOW 08/20



Models: Air Techniques: 53020 & 53020-1; Apollo/Midmark: ASAHWFB34, ASAHWFB34B, ASAHWFB34C, ASAWCFB34, ASAWCFB34B, ASAWCFB34C, ASAWFB34, ASAWFB34B & ASAWFB34C; Matrix/Midmark: FBR-34R; Midmark: 77002146; Tech West: WB-750, WB-750-RC, WBF-750 & WBF-750-RC

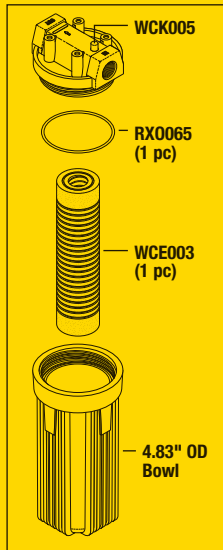

RPI Part #WCA001
OEM Part #53058;
53097; PFM70330;
7700077; WFB-750

FILTER HOUSING ASSEMBLY

- Ports: 3/4" FPT
 - 5 Micron Filtration
 - Includes all parts as shown and PM Sticker
 - Also available: Spanner Wrench (RPI Part #WCT007)
 - Recommended annual replacement for the Filter Element (5 Micron) (RPI Part #WCE003)
- Fits: Water Control Systems**

RPI Part #WCE003
OEM Part #53035; PFM85240;
77000300; WFE-750

FILTER ELEMENT (5 MICRON)

- 2 per package
 - Size: 2.50" OD x 9.88" lg.
 - Includes all parts as shown and PM Stickers
 - Recommended annual replacement for the Filter Element
- Fits: 3/4" Filter Housing Assembly**



RPI Part #RX0065
OEM Part #53106;
MRP70950; 77007010

O-RING

- 2 per package
 - Size: 3.859" ID x 4.137" OD x .139" C/S
 - Material: Nitrile (Buna-N), 70 Duro
 - Included in: Filter Element (5 Micron) (RPI Part #WCE003)
- Fits: 3/4" Filter Housing Assembly**

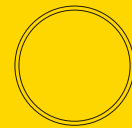

RPI Part #WCK005
OEM Part # (No OEM Number Available)

PRESSURE RELIEF BUTTON KIT

- Includes all parts as shown
- Fits: Water Control Systems**

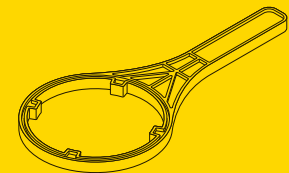
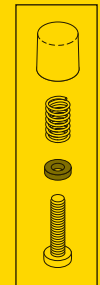

RPI Part #WCT007
OEM Part #MMS71173; 7700069

SPANNER WRENCH

- Wrench for 4.83" OD Bowl
- Fits: 4.83" OD Filter Housing Assembly**

Models: DentalEZ/Custom Air/Ramvac: WC110, WC210 & WC230

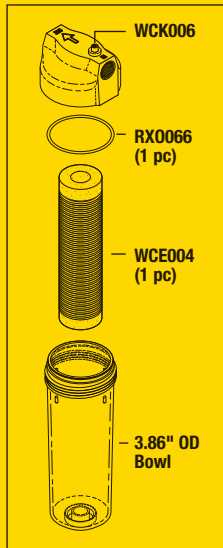

RPI Part #WCA002
OEM Part #64545021

FILTER HOUSING ASSEMBLY

- Ports: 3/4" FPT
 - 5 Micron Filtration
 - Includes all parts as shown and PM Sticker
 - Also available: Spanner Wrench (RPI Part #WCT008)
 - Recommended annual replacement for the Filter Element (5 Micron) (RPI Part #WCE004)
- Fits: Water Control Systems**

RPI Part #WCE004
OEM Part #64520006

FILTER ELEMENT (5 MICRON)

- 2 per package
 - Size: 2.50" OD x 9.88" lg.
 - Includes all parts as shown and PM Stickers
 - Recommended annual replacement for the Filter Element
- Fits: 3/4" Filter Housing Assembly**

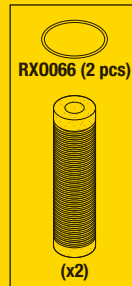

RPI Part #RX0066
OEM Part # (No OEM Number Available)

O-RING

- 2 per package
 - Size: 3.484" ID x 3.762" OD x .139" C/S
 - Material: Nitrile (Buna-N), 70 Duro
 - Included in: Filter Element (5 Micron) (RPI Part #WCE004)
- Fits: 3/4" Filter Housing Assembly**



RPI Part #WCK006
OEM Part # (No OEM Number Available)

PRESSURE RELIEF BUTTON KIT

- Includes all parts as shown
- Fits: Water Control Systems**

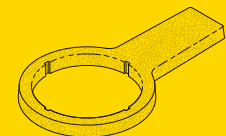

RPI Part #WCT008
OEM Part # (No OEM Number Available)

SPANNER WRENCH

- Wrench for 3.86" OD Bowl
- Fits: 3.86" OD Filter Housing Assembly**

Models: Air Techniques: 53170 & 53171; Apollo/Midmark: ASAWFB100, ASAWFB100B & ASAWFB100C; Matrix/Midmark: FBP-100R; Midmark: 77002147; Tech West: WBF-100 & WBF-100-RC

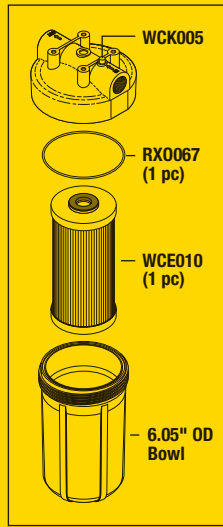

RPI Part #WCA009
OEM Part #53172;
77000073; 64545051;
WFB-1

FILTER HOUSING ASSEMBLY

- Ports: 1" FPT
 - 5 Micron Filtration
 - Includes all parts as shown and PM Sticker
 - Also available: Spanner Wrench (RPI Part #WCT012)
 - Recommended annual replacement for the Filter Element (5 Micron) (RPI Part #WCE010)
- Fits:** Water Control Systems

RPI Part #WCE010
OEM Part #53153;
PFM85241; 77000473;
64520012; WPE-100

FILTER ELEMENT (5 MICRON)

- 2 per package
 - Size: 4.50" OD x 9.75" lg.
 - Includes all parts as shown and PM Stickers
 - Recommended annual replacement for the Filter Element
- Fits:** 1", 1-1/4", and 1-1/2" Filter Housing Assy.

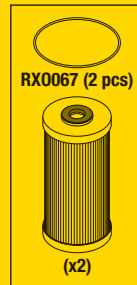

RPI Part #RX0067
OEM Part #53172-1;
MRP70951; 65977200;
64553032

O-RING

- 2 per package
 - Size: 5.510" ID x 5.850" OD x .170" C/S
 - Material: Nitrile (Buna-N), 70 Duro
 - Included in: Filter Element (5 Micron) (RPI Part #WCE010)
- Fits:** 1", 1-1/4", and 1-1/2" Filter Housing Assy.

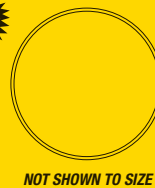

RPI Part #WCK005

OEM Part # (No OEM Number Available)

PRESSURE RELIEF BUTTON KIT

- Includes all parts as shown
- Fits:** Water Control Systems



RPI Part #WCT012

OEM Part #77000063

SPANNER WRENCH

- Wrench for 6.05" OD Bowl
- Fits:** 6.05" OD Filter Housing Assembly

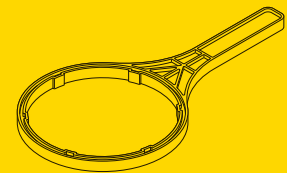

Models: Apollo/Midmark: ASAWFB150 & ASAWFB150C; Matrix/Midmark: FBP-150R; Midmark: 77002149

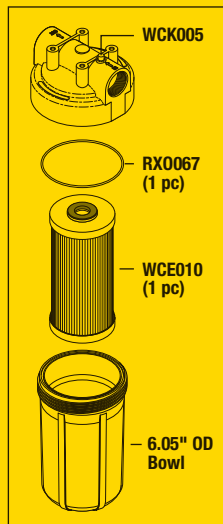

RPI Part #WCA014
OEM Part #7700073

FILTER HOUSING ASSEMBLY

- Ports: 1-1/2" FPT
 - 5 Micron Filtration
 - Includes all parts as shown and PM Sticker
 - Also available: Spanner Wrench (RPI Part #WCT012)
 - Recommended annual replacement for the Filter Element (5 Micron) (RPI Part #WCE010)
- Fits:** Water Control Systems

RPI Part #WCE010
OEM Part #53153;
PFM85241; 77000473;
64520012; WPE-100

FILTER ELEMENT (5 MICRON)

- 2 per package
 - Size: 4.50" OD x 9.75" lg.
 - Includes all parts as shown and PM Stickers
 - Recommended annual replacement for the Filter Element
- Fits:** 1", 1-1/4", and 1-1/2" Filter Housing Assy.

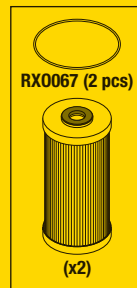

RPI Part #RX0067
OEM Part #53172-1;
MRP70951; 65977200;
64553032

O-RING

- 2 per package
 - Size: 5.510" ID x 5.850" OD x .170" C/S
 - Material: Nitrile (Buna-N), 70 Duro
 - Included in: Filter Element (5 Micron) (RPI Part #WCE010)
- Fits:** 1", 1-1/4", and 1-1/2" Filter Housing Assy.

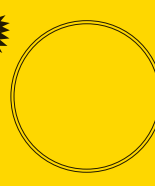

RPI Part #WCK005

OEM Part # (No OEM Number Available)

PRESSURE RELIEF BUTTON KIT

- Includes all parts as shown
- Fits:** Water Control Systems



RPI Part #WCT012

OEM Part #77000063

SPANNER WRENCH

- Wrench for 6.05" OD Bowl
- Fits:** 6.05" OD Filter Housing Assembly

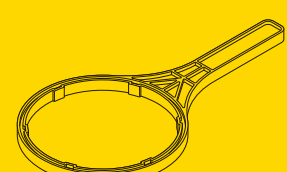

Models: Apollo/Midmark: ASAWFB125 & ASAWFB125C; DentalEZ/Custom Air/Ramvac: WC400 & WC410; Matrix/Midmark: FBP-125R; Midmark: 77002148

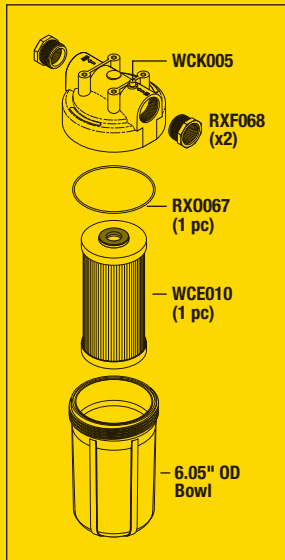

RPI Part #WCA013
OEM Part #7700073; 64622048; 64622102

FILTER HOUSING ASSEMBLY

- Ports: 1-1/4" FPT
 - 5 Micron Filtration
 - Includes all parts as shown and PM Sticker
 - Also available: Spanner Wrench (RPI Part #WCT012)
 - Recommended annual replacement for the Filter Element (5 Micron) (RPI Part #WCE010)
- Fits:** Water Control Systems



RPI Part #WCE010
OEM Part #53153; PFM85241; 77000473; 64520012; WPE-100

FILTER ELEMENT (5 MICRON)

- 2 per package
 - Size: 4.50" OD x 9.75" lg.
 - Includes all parts as shown and PM Stickers
 - Recommended annual replacement for the Filter Element
- Fits:** 1", 1-1/4", and 1-1/2" Filter Housing Assy.

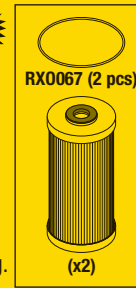

RPI Part #WCK005
OEM Part # (No OEM Number Available)

PRESSURE RELIEF BUTTON KIT

- Includes all parts as shown

Fits: Water Control Systems

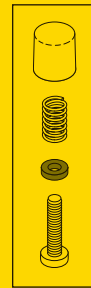

RPI Part #RXF068
OEM Part # (No OEM Number Available)

ADAPTOR (1-1/2" MPT x 1-1/4" FPT)

- Material: White PVC
- Fits:** 1-1/2" Filter Housing Assembly



RPI Part #RX0067
OEM Part #53172-1; MRP70951; 65977200; 64553032

O-RING

- 2 per package
 - Size: 5.510" ID x 5.850" OD x .170" C/S
 - Material: Nitrile (Buna-N), 70 Duro
 - Included in: Filter Element (5 Micron) (RPI Part #WCE010)
- Fits:** 1", 1-1/4", and 1-1/2" Filter Housing Assy.

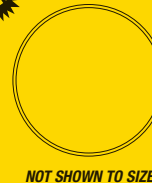

RPI Part #WCT012
OEM Part #77000063

SPANNER WRENCH

- Wrench for 6.05" OD Bowl
- Fits:** 6.05" OD Filter Housing Assembly

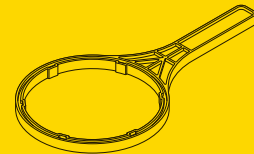

Service Essentials - Tools, Tape, Sealant and Lube

RPI Part #RPA459
OEM Part # (No OEM Number Available)

PIPE SEALANT 567

- .20 fl. oz. (6ml) per unit
- Temperature range: -65°F to 400°F (-54° to 204°C)

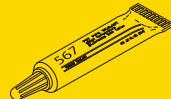

RPI Part #RPT579
OEM Part # (No OEM Number Available)

1/4" TEFLON THREAD SEALING TAPE

- 5 per package
- 1/4" x 260" per unit



RPI Part #RPL090
OEM Part # (No OEM Part # Available)

HIGH TEMP LUBRICANT

- 5 per package; 1/2 gram per unit
- Used on purge valves, pump packaging, gate valves, butterfly valves, sanitary valves, rubber and plastic o-rings, stems and pistons



RPI Part #RPT580
OEM Part # (No OEM Number Available)

1/2" TEFLON THREAD SEALING TAPE

- 5 per package
- 1/2" x 260" per unit



RPI Part #ILS014
OEM Part # (No OEM Part # Available)

SPANNER WRENCH

- Size: .525" ID x .875" HEX x .250" THK
- Replacement end attachment for Double Ended Spanner Wrench (RPI Part #RPT501) or use as a stand alone Spanner Nut

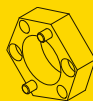

RPI Part #RPT501
OEM Part # (No OEM Part # Available)

DOUBLE ENDED SPANNER WRENCH

- Size: .875" HEX x 7" lg.
- Material: Aluminum handle with stainless steel end attachments
- Includes all parts as shown

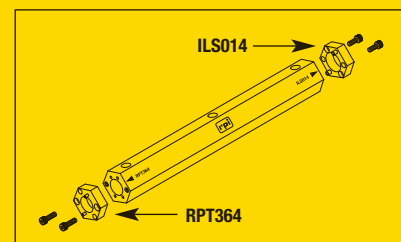

Models: Air Techniques: 53020, 53021; DentalEZ/Custom Air/Ramvac: WC210, WC230



Brass Body

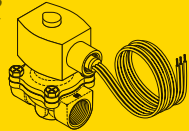

RPI Part #WCV018
OEM Part #53031 (Brass);
64622129 (SS)

SOLENOID VALVE

- 24VAC; Ports: 3/4" FPT
- Also available: Solenoid Valve Repair Kit (RPI Part #WCK020) for **brass** body solenoid valves. For OEM solenoid valves with **stainless steel** bodies, ask for the Solenoid Valve Repair Kit (RPI Part #WCK021).

Fits: Water Control Assembly

RPI BRASS VALVE REPAIR KIT

RPI Part #WCK020
OEM Part # (No OEM Number Available)

SOLENOID VALVE REPAIR KIT

- Includes all parts as shown
- **ONLY** Fits the **Brass Body** Solenoid Valve

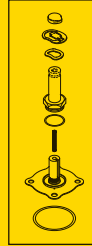

OEM S.S. VALVE REPAIR KIT

RPI Part #WCK021
OEM Part # (No OEM Number Available)

SOLENOID VALVE REPAIR KIT

- Includes all parts as shown plus a spanner nut
- **ONLY** Fits the DentalEZ **Stainless Steel** Body Valve #64622129

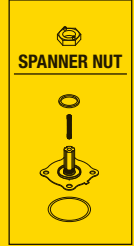

Models: Air Techniques: 53170 & 53173; DentalEZ/Custom Air/Ramvac: WC300



Brass Body

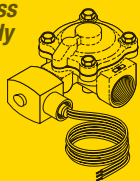

RPI Part #WCV026
OEM Part #53154 (Brass);
64622130 (SS)

SOLENOID VALVE

- 24VAC; Ports: 1" FPT
- Also available: Solenoid Valve Repair Kit (RPI Part #WCK028) for **brass** body solenoid valves. For OEM solenoid valves with **stainless steel** bodies, ask for the Solenoid Valve Repair Kit (RPI Part #WCK035).

Fits: Water Control Assembly

RPI BRASS VALVE REPAIR KIT

RPI Part #WCK028
OEM Part # (No OEM Number Available)

SOLENOID VALVE REPAIR KIT

- Includes all parts as shown
- **ONLY** Fits the **Brass Body** Solenoid Valve

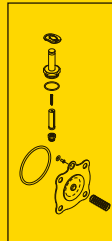

OEM S.S. VALVE REPAIR KIT

RPI Part #WCK035
OEM Part # (No OEM Number Available)

SOLENOID VALVE REPAIR KIT

- Includes all parts as shown
- **ONLY** Fits the DentalEZ **Stainless Steel** Body Valve #64622130

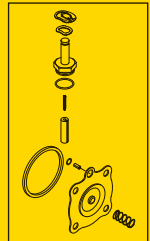

Models: DentalEZ/Custom Air/Ramvac: WC110



Brass Body

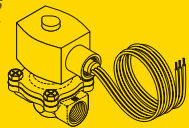

RPI Part #WCV015
OEM Part #64622128 (SS)

SOLENOID VALVE

- 24VAC; Ports: 1/2" FPT
- Also available: Solenoid Valve Repair Kit (RPI Part #WCK016) for **brass** body solenoid valves. For OEM solenoid valves with **stainless steel** bodies, ask for the Solenoid Valve Repair Kit (RPI Part #WCK011).

Fits: Water Control Assembly

RPI BRASS VALVE REPAIR KIT

RPI Part #WCK016
OEM Part # (No OEM Number Available)

SOLENOID VALVE REPAIR KIT

- Includes all parts as shown
- **ONLY** Fits the **Brass Body** Solenoid Valve

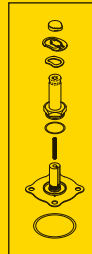

OEM S.S. VALVE REPAIR KIT

RPI Part #WCK011
OEM Part # (No OEM Number Available)

SOLENOID VALVE REPAIR KIT

- Includes all parts as shown plus a spanner nut
- **ONLY** Fits the DentalEZ **Stainless Steel** Body Valve #64622128

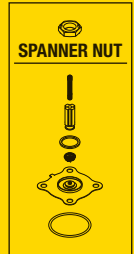

Models: Air Techniques: 53171 & 53174; Apollo/Midmark: ASAWB100 & ASAWFB100; Matrix/Midmark: FBP-100R; Midmark: 77002147



Brass Body

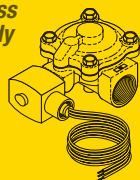

RPI Part #WCV029
OEM Part #53155 (Brass);
PVV10476 (Brass); 65976500 (SS)

SOLENOID VALVE

- 120VAC; Ports: 1" FPT
- Also available: Solenoid Valve Repair Kit (RPI Part #WCK028) for **brass** body solenoid valves. For OEM solenoid valves with **stainless steel** bodies, ask for the Solenoid Valve Repair Kit (RPI Part #WCK030).

Fits: Water Control Assembly

RPI BRASS VALVE REPAIR KIT

RPI Part #WCK028
OEM Part # (No OEM Number Available)

SOLENOID VALVE REPAIR KIT

- Includes all parts as shown
- **ONLY** Fits the **Brass Body** Solenoid Valve

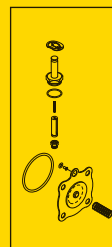

OEM S.S. VALVE REPAIR KIT

RPI Part #WCK030
OEM Part #77001648

SOLENOID VALVE REPAIR KIT

- Includes all parts as shown
- **ONLY** Fits the Midmark **Stainless Steel** body Valve #65976500

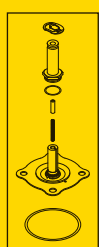



replacement parts industries, inc.

625 Cochran Street • Simi Valley, California • 93065

PRESORTED STANDARD
U.S. POSTAGE PAID
VAN NUYS, CA
PERMIT NO. 2399

ADDRESS SERVICES REQUESTED

Models: **Matrx/Midmark:** FBP-34R; **Midmark:** 77002146

RPI Part #WCV023
OEM Part #62970303 (SS)

SOLENOID VALVE

- 120VAC; Ports: 3/4" FPT
- Also available: Solenoid Valve Repair Kit (RPI Part #CSK050) for **brass** body solenoid valves. For OEM solenoid valves with **stainless steel** bodies, ask for the Solenoid Valve Repair Kit (RPI Part #WCK024).

Fits: Water Control Assembly

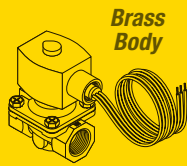

Brass Body

RPI BRASS VALVE REPAIR KIT

RPI Part #CSK050
OEM Part # (No OEM Number Available)

SOLENOID VALVE REPAIR KIT

- Includes all parts as shown
- **ONLY** Fits the **Brass Body** Solenoid Valve

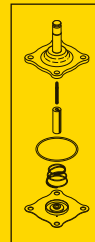

OEM S.S. VALVE REPAIR KIT

RPI Part #WCK024
OEM Part #77000997

SOLENOID VALVE REPAIR KIT

- Includes all parts as shown
- **ONLY** Fits the **Midmark Stainless Steel Body Valve #62970303**

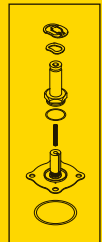

Models: **Matrx/Midmark:** 77002149 (Newer Matrx), 77000045 (Older Matrx); **Midmark:** 77002149

RPI Part #WCV032
OEM Part #65910800 (SS)

SOLENOID VALVE

- 120vac; Ports: 1-1/2" FPT
- Also available: Solenoid Valve Repair Kit (RPI Part #WCK033) for **brass** body solenoid valves. For OEM solenoid valves with **stainless steel** bodies, ask for the Solenoid Valve Repair Kit (RPI Part #WCK034).

Fits: Water Control Assembly

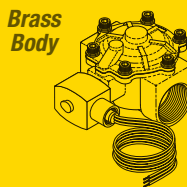

Brass Body

RPI BRASS VALVE REPAIR KIT

RPI Part #WCK033
OEM Part # (No OEM Number Available)

SOLENOID VALVE REPAIR KIT

- Includes all parts as shown
- **ONLY** For the **Brass Body** Solenoid Valve

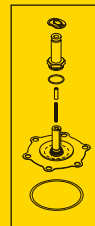

OEM S.S. VALVE REPAIR KIT

RPI Part #WCK034
OEM Part #77000967

SOLENOID VALVE REPAIR KIT

- Includes all parts as shown
- **ONLY** Fits the **Midmark Stainless Steel Body Valve #65910800**

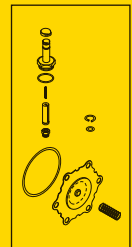

Models: **Air Techniques:** 53020-1 & 53021-1

RPI Part #WCV022
OEM Part #53031-1 (Brass)

SOLENOID VALVE

- 120VAC; Ports: 3/4" FPT
- Fits:** Water Control Assembly

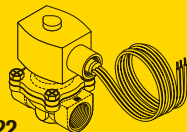

Brass Body

REPAIR KIT

RPI Part #WCK020
OEM Part # (No OEM Number Available)

SOLENOID VALVE REPAIR KIT

- Includes all parts as shown
- Fits:** Solenoid Valve

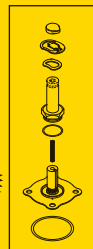

Models: **Tech West:** WB-100-RC & WBF-100-RC

RPI Part #WCV025
OEM Part #WMV-100

SOLENOID VALVE

- 120VAC; Ports: 1" FPT
- Fits:** Water Control Assembly

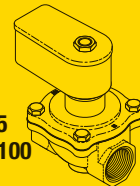

Brass Body

REPAIR KIT

RPI Part #WCK027
OEM Part # (No OEM Number Available)

SOLENOID VALVE REPAIR KIT

- Includes all parts as shown
- Fits:** Solenoid Valve



Models: **Midmark:** 77002148

RPI Part #WCV031
OEM Part #65976900 (Brass)

SOLENOID VALVE

- 120VAC; Ports: 1-1/4" FPT
- Fits:** Water Control Assembly

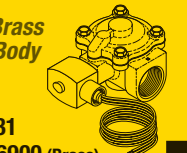

Brass Body

REPAIR KIT

RPI Part #WCK028
OEM Part # (No OEM Number Available)

SOLENOID VALVE REPAIR KIT

- Includes all parts as shown
- Fits:** Solenoid Valve



Models: **Tech West:** WB-750-RC & WBF-750-RC

RPI Part #WCV017
OEM Part #WMV-750

SOLENOID VALVE

- 120VAC; Ports: 3/4" FPT
- Fits:** Water Control Assembly

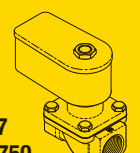

Brass Body

REPAIR KIT

RPI Part #WCK019
OEM Part # (No OEM Number Available)

SOLENOID VALVE REPAIR KIT

- Includes all parts as shown
- Fits:** Solenoid Valve

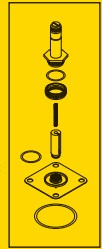

RPI Parts for Dental Utility Room Water Control Systems!

Models these RPI Parts fit							
RPI PART #	DESCRIPTION	AIR TECHNIQUES	APOLLO/ MIDMARK®	DENTAL EZ®/ CUSTOM AIR/RAMVAC	MATRIX/MIDMARK®	MIDMARK®	TECH WEST
FILTER ELEMENTS							
WCE003	FILTER ELEMENT (5 MICRON)	53020 & 53020-1	ASAHWF34, ASAHWF34B, ASAHWF34C, ASAWCFB34, ASAWCFB34B, ASAWCFB34C, ASAWFB34, ASAWFB34B & ASAWFB34C		FBR-34R	77002146	WBF-750 & WBF-750-RC
WCE004	FILTER ELEMENT (5 MICRON)			WC110, WC210 & WC230			
WCE010	FILTER ELEMENT (5 MICRON)	53170 & 53171	ASAWFB100, ASAWFB100B, ASAWFB100C, ASAWFB125, ASAWFB125C, ASAWFB150 & ASAWFB150C	WC300, WC310, WC400 & WC410	FBP-100R, FBP-125R & FBP-150R	77002147, 77002148 & 77002149	WBF-100 & WBF-100-RC
FILTER HOUSING ASSEMBLIES							
WCA001	FILTER HOUSING ASSEMBLY	53020 & 53020-1	ASAHWF34, ASAHWF34B, ASAHWF34C, ASAWCFB34, ASAWCFB34B, ASAWCFB34C, ASAWFB34, ASAWFB34B & ASAWFB34C		FBR-34R	77002146	WBF-750 & WBF-750-RC
WCA002	FILTER HOUSING ASSEMBLY			WC110, WC210 & WC230			
WCA009	FILTER HOUSING ASSEMBLY	53170 & 53171	ASAWFB100, ASAWFB100B & ASAWFB100C		FBP-100R	77002147	WBF-100, WBF-100-RC
WCA013	FILTER HOUSING ASSEMBLY		ASAWFB125 & ASAWFB125C	WC400 & WC410	FBP-125R	77002148	
WCA014	FILTER HOUSING ASSEMBLY		ASAWFB150 & ASAWFB150C		FBP-150R	77002149	
O-RINGS							
RX0065	O-RING	53020 & 53020-1	ASAHWF34, ASAHWF34B, ASAHWF34C, ASAWCFB34, ASAWCFB34B, ASAWCFB34C, ASAWFB34, ASAWFB34B & ASAWFB34C		FBR-34R	77002146	WB-750, WB-750-RC, WBF-750 & WBF-750-RC
RX0066	O-RING			WC110, WC210 & WC230			
RX0067	O-RING	53170 & 53171	ASAWFB100, ASAWFB100B, ASAWFB100C, ASAWFB125, ASAWFB125C, ASAWFB150 & ASAWFB150C	WC300, WC310, WC400 & WC410	FBP-100R, FBP-125R & FBP-150R	77002147, 77002148 & 77002149	WBF-100 & WBF-100-RC
PRESSURE RELIEF BUTTON KITS							
WCK005	PRESSURE RELIEF BUTTON KIT	3/4" & 1" Water Control Systems	ASAHWF34, ASAHWF34B, ASAHWF34C, ASAWCFB34, ASAWCFB34B, ASAWCFB34C, ASAWFB34, ASAWFB34B, ASAWFB34C, ASAWFB100, ASAWFB100B, ASAWFB100C, ASAWFB125, ASAWFB125C, ASAWFB150 & ASAWFB150C	WC400 & WC410	3/4", 1", 1-1/4" & 1-1/2" Water Control Systems	3/4", 1", 1-1/4" & 1-1/2" Water Control Systems	WBF-750, WBF-750-RC, WBF-100 & WBF-100-RC
WCK006	PRESSURE RELIEF BUTTON KIT			WC110, WC210 & WC230			
SOLENOID VALVES							
WCV015	SOLENOID VALVE			WC110			
WCV017	SOLENOID VALVE						WB-750-RC & WBF-750-RC
WCV018	SOLENOID VALVE	53020 & 53021		WC210 & WC230			
WCV022	SOLENOID VALVE	53020-1 & 53021-1					
WCV023	SOLENOID VALVE				FBR-34R	77002146	
WCV025	SOLENOID VALVE						WB-100-RC & WBF-100-RC
WCV026	SOLENOID VALVE	53170 & 53173		WC300			
WCV029	SOLENOID VALVE	53171 & 53174	ASAWB100, ASAWFB100		FBP-100R	77002147	
WCV031	SOLENOID VALVE					77002148	
WCV032	SOLENOID VALVE				77002149 (Newer Matrix) & 77000045 (Older Matrix)	77002149	
SOLENOID VALVE REPAIR KITS							
CSK050	SOLENOID VALVE REPAIR KIT				FBR-34R	77002146	
WCK011	SOLENOID VALVE REPAIR KIT			WC110			
WCK016	SOLENOID VALVE REPAIR KIT			WC110			
WCK019	SOLENOID VALVE REPAIR KIT						WB-750-RC & WBF-750-RC
WCK020	SOLENOID VALVE REPAIR KIT	53020, 53021, 53020-1 & 53021-1		WC210 & WC230			
WCK021	SOLENOID VALVE REPAIR KIT			WC210 & WC230			
WCK024	SOLENOID VALVE REPAIR KIT					77002146	
WCK027	SOLENOID VALVE REPAIR KIT						WB-100-RC & WBF-100-RC
WCK028	SOLENOID VALVE REPAIR KIT	53170, 53171, 53173 & 53174	ASAWB100, ASAWFB100	WC300	FBP-100R	77002147 & 77002148	
WCK030	SOLENOID VALVE REPAIR KIT					77002147	
WCK033	SOLENOID VALVE REPAIR KIT				77002149 (Newer Matrix) & 77000045 (Older Matrix)	77002149	
WCK034	SOLENOID VALVE REPAIR KIT				FBP-150R	77002149	
WCK035	SOLENOID VALVE REPAIR KIT			WC300			
SPANNER WRENCHES							
ILS014	SPANNER WRENCH	53020, 53020-1, 53021, 53021-1, 53170, 53171, 53173 & 53174	ASAWB34, ASAWB34C, ASAWB100, ASAWB100C, ASAWB125, ASAWB125C, ASAWB150, ASAWB150C, ASAWCFB34, ASAWCFB34C, ASAWFB34, ASAWFB34C, ASAWFB100, ASAWFB100C, ASAWFB125, ASAWFB125C, ASAWFB150, ASAWFB150C, ASAHWF34 & ASAHWF34C	WC110, WC210, WC230 & WC300	FBP-12R, FBP-34R, FBP-100R, FBP-125R & FBP-150R	77002146, 77002147, 77002148 & 77002149	WB-100, WB-100-RC, WB-750, WB-750-RC, WBF-100, WBF-100-RC, WBF-750 & WBF-750-RC
RPT501	DOUBLE ENDED SPANNER WRENCH	53020, 53020-1, 53021, 53021-1, 53170, 53171, 53173 & 53174	ASAWB34, ASAWB34C, ASAWB100, ASAWB100C, ASAWB125, ASAWB125C, ASAWB150, ASAWB150C, ASAWCFB34, ASAWCFB34C, ASAWFB34, ASAWFB34C, ASAWFB100, ASAWFB100C, ASAWFB125, ASAWFB125C, ASAWFB150, ASAWFB150C, ASAHWF34 & ASAHWF34C	WC110, WC210, WC230 & WC300	FBP-12R, FBP-34R, FBP-100R, FBP-125R & FBP-150R	77002146, 77002147, 77002148 & 77002149	WB-100, WB-100-RC, WB-750, WB-750-RC, WBF-100, WBF-100-RC, WBF-750 & WBF-750-RC
WCT007	SPANNER WRENCH	53020 & 53020-1	ASAHWF34, ASAHWF34B, ASAHWF34C, ASAWCFB34, ASAWCFB34B, ASAWCFB34C, ASAWFB34, ASAWFB34B & ASAWFB34C		FBR-34R	77002146	WB-750, WB-750-RC, WBF-750 & WBF-750-RC
WCT008	SPANNER WRENCH			WC110, WC210 & WC230			
WCT012	SPANNER WRENCH	53170 & 53171	ASAWFB100, ASAWFB100B, ASAWFB100C, ASAWFB125, ASAWFB125C, ASAWFB150 & ASAWFB150C	WC300, WC310, WC400 & WC410	FBP-100R, FBP-125R & FBP-150R	77002147, 77002148 & 77002149	WBF-100 & WBF-100-RC
ACCESSORIES							
RPA459	PIPE SEALANT 567	53020, 53020-1, 53021, 53170, 53171, 53173 & 53174	ASAWB100, ASAHWF34, ASAHWF34B, ASAHWF34C, ASAWCFB34, ASAWCFB34B, ASAWCFB34C, ASAWFB34, ASAWFB34B, ASAWFB34C, ASAWFB100, ASAWFB100C, ASAWFB125, ASAWFB125C, ASAWFB150 & ASAWFB150C	WC110, WC210, WC230, WC300, WC400 & WC410	FBR-34R, FBP-100R, FBP-125R, FBP-150R, 77002149 (Newer Matrix) & 77000045 (Older Matrix)	77002146, 77002147, 77002148 & 77002149	WB-100-RC, WBF-100-RC, WBF-750 & WBF-750-RC
RPL090	HIGH TEMP LUBRICANT	53020, 53020-1, 53021, 53170, 53171, 53173 & 53174	ASAWB34, ASAWB34C, ASAWB100, ASAWB100C, ASAWB125, ASAWB125C, ASAWB150, ASAWB150C, ASAWCFB34, ASAWCFB34C, ASAWFB34, ASAWFB34B, ASAWFB34C, ASAWFB100, ASAWFB100C, ASAWFB125, ASAWFB125C, ASAWFB150, ASAWFB150C, ASAHWF34 & ASAHWF34C	WC110, WC210, WC230 & WC300	FBP-12R, FBP-34R, FBP-100R, FBP-125R & FBP-150R		WB-100, WB-100-RC, WB-750, WB-750-RC, WBF-100, WBF-100-RC, WBF-750 & WBF-750-RC
RPT579	1/4" TEFLON THREAD SEALING TAPE	53020, 53020-1, 53021, 53170, 53171, 53173 & 53174	ASAWB100, ASAHWF34, ASAHWF34B, ASAHWF34C, ASAWCFB34, ASAWCFB34B, ASAWCFB34C, ASAWFB34, ASAWFB34B, ASAWFB34C, ASAWFB100, ASAWFB100B, ASAWFB100C, ASAWFB125, ASAWFB125C, ASAWFB150 & ASAWFB150C	WC110, WC210, WC230, WC300, WC400 & WC410	FBR-34R, FBP-100R, FBP-125R, FBP-150R, 77002149 (Newer Matrix) & 77000045 (Older Matrix)	77002146, 77002147, 77002148 & 77002149	WB-100-RC, WBF-100-RC, WBF-750 & WBF-750-RC
RPT580	1/2" TEFLON THREAD SEALING TAPE	53020, 53020-1, 53021, 53170, 53171, 53173 & 53174	ASAWB100, ASAHWF34, ASAHWF34B, ASAHWF34C, ASAWCFB34, ASAWCFB34B, ASAWCFB34C, ASAWFB34, ASAWFB34B, ASAWFB34C, ASAWFB100, ASAWFB100B, ASAWFB100C, ASAWFB125, ASAWFB125C, ASAWFB150 & ASAWFB150C	WC110, WC210, WC230, WC300, WC400 & WC410	FBR-34R, FBP-100R, FBP-125R, FBP-150R, 77002149 (Newer Matrix) & 77000045 (Older Matrix)	77002146, 77002147, 77002148 & 77002149	WB-100-RC, WBF-100-RC, WBF-750 & WBF-750-RC
RXF068	ADAPTOR (1-1/2" MPT x 1-1/4" FPT)		ASAWFB125 & ASAWFB125C	WC400 & WC410	FBP-125R	77002148	



Proud to be a Healthcare Components Group brand ...



HEALTHCARE
Components Group

DENTAL WATER CONTROLS -

Air Techniques, Apollo/Midmark, DentaleEZ/
Custom Air/Ramvac, Matrx/Midmark,
Midmark, & Tech West

New
Parts
to fit

Dental Utility Room Water Control Systems!



RPI Part #WCP036
OEM Part #64637011

POWER SUPPLY

- 24VAC/50VA Class 2 plug-in with thermal cut-out
- Includes: Case with mounting tab and screw terminals

Fits: Wall Power Plug

Models: DentaleZ/Custom Air/Ramvac: WC110, WC210, WC230 & WC300



RPI Part #WCP037
OEM Part #77000067; 77000068

LOW VOLTAGE CONTROL RELAY

- Provides switching for high current loads
- Coil: 24VAC
- DPST; contacts rated 100VA @ 120VAC, 50VA @ 240VAC

Fits: Low Voltage Control Assembly

Models: Matrx Medical • Matrx/Midmark: FBP-12R, FBP-34R, FBP-100R, FBP-125R, FBP-150R, 77000041, 77000042, 77000043, 77000044 & 77000045
Midmark®: 77002146, 77002147, 77002148 & 77002149



RPI Part #RXC041
OEM Part #EC-115

HOSPITAL GRADE POWER CORD (15A @ 125VAC, 10 ft.)

- Length: 10 ft. with jacket stripped 8"; Color: Gray
- 12/3 SJT, 105°C; 15A @ 125VAC
- Plug: NEMA 5-15P; Connector: None .453" O.D. cord
- Includes: (3 ea) #6 spade terminals

Fits: Relay Control 24V 115V

Models: Tech West: WB-100-RC, WB-750-RC, WBF-100-RC & WBF-750-RC

RPI Part #VPT146
OEM Part #PT-100

TRANSFORMER

- Primary: Dual 120VAC; 60Hz.
- Secondary: 24VAC @ 25A

Fits: Electrical Control Box/Relay Control 24V/115-230V

Models: Tech West: WB-100-RC, WB-750-RC, WBF-100-RC & WBF-750-RC



RPI Part #VPR148
OEM Part #55857 & 55407

RELAY (ELECTRICAL CONTACTOR)

- Coil: 24VAC, 11 ohms
- 2 pole, contacts rated at 30A; 1/4" Tabs

Fits: Vacuum Electrical Control Box/Relay Control 24V/115-230V

Models: Tech West: WB-100-RC, WB-750-RC, WBF-100-RC & WBF-750-RC

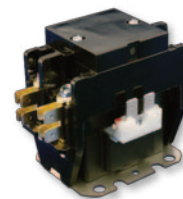

RPI Part #CAS042
OEM Part #TS-100

ON/OFF SWITCH ASSEMBLY

- Toggle switch (On-Off)
- 3A @ 250VAC; SPST
- 6" lg. #18 AWG wires
- Panel cutout: 1/2" dia.
- Includes: On-Off legend plate, mounting hardware, and (1 pc) Flag Terminal (1/4" QC) (RPI Part #RPT905)

Fits: Control Panel

Models: Tech West: WB-100-RC, WB-750-RC, WBF-100-RC & WBF-750-RC



RPI Part #RPH988
OEM Part #FH-100

FUSE HOLDER

- Accommodates 1/4" x 1-1/4" fuse; 20A @ 250VAC
- 3/16" Tabs
- Mounting hole size: .500" dia.
- Includes mounting hardware
- Also available for Tech West Vacuums: Fuse (1/4A, 250V) (RPI Part #RPF059)

Fits: Electrical Control Box/Relay Control 24V/115-230V

Models: Tech West: WB-100-RC, WB-750-RC, WBF-100-RC & WBF-750-RC



replacement parts industries, inc.

Add this page to your RPI catalog – Section 4, Page 1902

CALL (800) 221-9723 • FAX (818) 882-7028 • EMAIL order@ripiparts.com • WEBSITE www.rpiparts.com

The above parts are manufactured by Replacement Parts Industries, Inc. to fit the equipment noted. All product names used in this document are trademarks or registered trademarks of their respective holders. Web 08/22

SECTION

4

PAGE

1902

UPDATED

08/22

New Parts to fit Dental Utility Room Water Control Systems!



RPI Part #VPT142

OEM Part #54623, 54375, 55866, 55867, 56325, 85934, 86637, 85275 & 85362

TRANSFORMER

- Primary: 120/208/240VAC; 50/60Hz.
- Secondary: 24VAC @ 40A
- Size: 2-5/8" L x 2-3/16" W x 2-3/16" H; 1/4" Tabs
- Includes all parts as shown

Fits: Electrical Control Box/Relay Control 24V/115-230V

Models: Air Techniques: 53170, 53171, 53020, 53020-1, 53173, 53174, 53021 & 53021-1



RPI Part #RPC554

OEM Part # (No OEM Part # Available)

HOSPITAL GRADE POWER CORD (15A @ 125VAC, 8 ft.)

- Length: 8 ft.; Color: Gray
- 14/3 SJT, 105°C; 15A @ 125VAC
- Plug: NEMA 5-15P
- Connector Type: EN60320-C13

Fits: 24 Volt Water System Transformers

Models: Air Techniques: 53170, 53171, 53020, 53020-1, 53173, 53174, 53021 & 53021-1

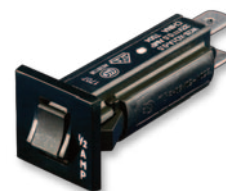

RPI Part #VPB182

OEM Part #117061

CIRCUIT BREAKER (1/2A)

- 1/2 Amp @ 250VAC
- 1/4" Tabs
- Panel cutout: 5/8" dia.
- Push to reset

Fits: Electrical Control Box/24 Volt Water System Transformers

Models: Air Techniques: 53170, 53171, 53020, 53020-1, 53173, 53174, 53021 & 53021-1



RPI Part #RPR583

OEM Part # (No OEM Part # Available)

AC INLET RECEPTACLE

- C13 style connector; 1/4" Tabs
- 15A @ 250VAC
- Fits panel cut-out: .787" x 1.083" (20mm x 27.5mm);
Mounting Holes: .134" dia. (3.4mm) @ 1.575" (40mm) centers

Fits: Panel/24 Volt Water System Transformers

Models: Air Techniques: 53170, 53171, 53020, 53020-1, 53173, 53174, 53021 & 53021-1



replacement parts industries, inc. A Healthcare Components Group Company

CALL (800) 221-9723 • FAX (818) 882-7028 • EMAIL order@rpiparts.com • WEBSITE www.rpiparts.com

OEM MODEL Section 5 Page #'s

ECG/EKG & EEG

BURDICK

Atria 3000	203
DC-175	201
DC-180	201
DC-185	200-201
DC-190	200
DC-195	201
E100	200
E200	200
E310	200
E320	200
E350 & E350I	202-203
E500 TW	200
E550	202-203
E560	202-203
E600	200
Eclipse	202-203
Eclipse 4	203
Eclipse 400	203
Eclipse 8	203
Eclipse 800	203
Eclipse 850	203
Eclipse LE	202-203
Eclipse LEI	202-203
Eclipse LEII	203
Eclipse Plus	203
EK-1	201-203
EK-2	201-203
EK-3	201-203
EK-4	201-203
EK-5	200-203
EK-5A	200-203
EK-6	200
EK-7	200
EK-8	200-201
EK-10	201-203
EK-670	200
Elite	202-203
Elite II	202-203
MC-600	200
Medic 3	202
Medic 4	202
Medic 5	202
MW200	201
MW225	201
PA-100	201
PA-101	201
PA-104	201
PA-107	201
Sirecust 630	202
Sirecust DU	202
TMS-302	200
UT420	201
UT4300	201

OEM MODEL Section 5 Page #'s

ESU

COVIDIEN/VALLEYLAB

Force 1C	600 & 602
Force 2-2	600-603
Force 2-8	600, 602 & 603
Force 4	600, 602 & 603
Force 30	600, 602 & 603
Force 40	600, 602 & 603
Force EZ	600, 602 & 603
Force EZ-8	600, 602 & 603
Force EZ-8C	600, 602 & 603
Force EZ-C	600, 602 & 603
Force FX	600-603
Force FX-8	600-603
Force FX-8C	600-603
Force FX-C	600-603
Force Triad	600 & 602

NON-INVASIVE BLOOD PRESSURE MONITORS

GE/CRITIKON

Dinamap™ 8100	300-301
Dinamap™ 8100T	300-301
Dinamap™ 8110	301
Dinamap™ 8120	301
Dinamap™ 9300	300-301
Dinamap™ 9340	300-301
Dinamap™ 9350	301
Dinamap™ 9400	301
Dinamap™ 9500XL	301

PATIENT, HOLTER & TELEMETRY CABLES

PATIENT, HOLTER & TELEMETRY CABLES

Accessories	402 & 417
Cables to fit GE Acquisition Modules	405
Din/Unshielded	402-403
Dual/Shielded	404-405
Dual/Shielded to fit GE Multi-Link®	405
Fixed	400-401
Holter Cables	406
Telemetry Cables	406-407

(continued)

PATIENT & HOLTER CABLE LEADWIRES

LEADWIRES & LEADWIRE SETS

Accessories	402 & 417
Bonded Leadwire Sets to fit GE Multi-Link®	408
Combined Leadwire Sets to fit GE Multi-Link® ...	409
Din/Unshielded Disposable Leadwire Sets ..	415-416
Din/Unshielded Individual Leadwires	412
Din/Unshielded Leadwire Sets	411-412
Dual/Shielded Disposable Leadwire Sets	416-417
Dual/Shielded Individual Leadwires	414
Dual/Shielded Leadwire Sets	413
Leadwire Sets to fit GE Multi-Link®	410
Veterinary Din/Unshielded Individual Leadwires .	419
Veterinary Din/Unshielded Leadwire Sets	418
Veterinary Dual/Shielded Individual Leadwires ..	419
Veterinary Dual/Shielded Leadwire Sets	418-419

WELCH ALLYN WALL TRANSFORMERS

WELCH ALLYN WALL TRANSFORMERS

767	500-501
11600 Ophthalmoscope	501
11605 Ophthalmoscope	501
11610 Ophthalmoscope	501
11710 Ophthalmoscope	501
11800 Ophthalmoscope	501
11810 Ophthalmoscope	501
11820 Ophthalmoscope	501
12400 Strabismoscope	501
18000 Retinoscope	501
20000 Otoscope	501
20200 Otoscope	501
20202 Otoscope	501
21700 Otoscope	501
23810 Otoscope	501
23820 Otoscope	501
25000 Otoscope	501
25020 Otoscope	501
25200 Otoscope	501
26530 Illuminator	501
27000 Illuminator	501
27050 Illuminator	501
28100 Tongue Blade Holder	501
43700 Episcopes	501
43300 Illuminator	501
43700 Episcopes	501
73500 Handler Adapter	501
74710	500-501

Patient, Holter & Telemetry Cables

PATIENT CABLE TYPE Found on Page #'s	FIXED 400-401	DIN/ UNSHIELDED 402-403	DUAL/ SHIELDED 404-405
PATIENT, HOLTER & TELEMETRY CABLES			
ABBOTT AAEMM, AAXM, ABBV, ABBY SERIES, ABEM, ABTM & EX-50 • Leadwire sets also available, see pages 408-419.		KCA004	KEC010
ABBOTT EKR50 & EXPI • Leadwire sets also available, see pages 408-419.			KEC010
ABBOTT LIFECARE 5100 & 5200 • Leadwire sets also available, see pages 408-419.	KCB008 ¹ KEB012 ²	KCA007	KCC009
ACCUCORE/PIC/VITALCOM TELEMETRY SYSTEM 3 LEAD ^KCB028 (Telemetry cable), see page 406.	KCB028^		
ACCUCORE/PIC/VITALCOM TELEMETRY SYSTEM 4 LEAD ^KDB002 (Telemetry cable), see page 407.	KDB002^		
ACCUCORE/PIC/VITALCOM TELEMETRY SYSTEM 5 LEAD ^KEB015 (Telemetry cable), see page 407.	KEB015^		
ADVANCED TECH LABS SEE ATL			
AGILENT SEE HEWLETT PACKARD/AGILENT/ZYMED/PHILIPS MEDICAL			
A.I.R. 3000 HOLTER (3 Channel 7 LEAD) ^ KGA001 (Holter cable), see page 406. • Leadwire sets also available, see pages 408-419.		KGA001^	
AIR SHIELDS/HILL ROM/VICKER/NARCO HRRM-71, HRRM-72, PORTAFIB I, PORTAFIB II, & SYSTEM 6 NEONATAL • Leadwire sets also available, see pages 408-419.	KCB002	KCA001	KCC003
AIR SHIELDS/HILL ROM/VICKER/NARCO PORTAFIB III & SYSTEM 5 NEW • Leadwire sets also available, see pages 408-419.	KCB002	KCA001	KCC003 ¹ KEC010 ²
AMERICAN OPTICAL 1125, 1700 & PULSAR 4 • Leadwire sets also available, see pages 408-419.	KCB002	KCA001	KCC003
AMERICAN OPTICAL 5260, 5330, 26125 & 33167 • Leadwire sets also available, see pages 408-419.	KCB002	KCA001	
ATL 400; 800; 800 PLUS; VERA MARK; and ULTRAMARK 4, 4 PLUS, 5, 7 & 9 • Leadwire sets also available, see pages 408-419.	KCB002	KCA001	KCC003
BECTON DICKINSON SEE ELECTRODYNE/BECTON DICKINSON/DATAMEDIX/PPG			
BIOCHEM INT'L 3101, 3404, 6100, 9100, ADVISOR & AUTOCORR • Leadwire sets also available, see pages 408-419.	KCB002	KCA001	KCC003
BIONET CARDIOCARE 2000 & CARDIOTOUCH 3000	KKB002		
BIRTCHER 300, 335 & 337	KEB014 ³		
BIRTCHER 365 CARDIOTRACER, 375 CARDIOTRACER & 375-11	KKB002		
BRAEMER DL125 & DL1700 ^ KGA001 (Holter cable), see page 406. • Leadwire sets also available, see pages 408-419.		KGA001^	
BURDICK/SIEMENS ATRIA 3000; ECLIPSE 4, 8, 400, 800, 850, 850 PLUS; ECLIPSE LE II; PLUS	KKB008		
BURDICK/SIEMENS EK-1, EK-2, EK-3, EK-4, EK-5 & EK-5A	KEB014 ³		

¹ 3 Leadwire Patient Cable ² 5 Leadwire Patient Cable ³ Old RPI Part #BUC009

PATIENT CABLE TYPE Found on Page #'s	FIXED 400-401	DIN/ UNSHIELDED 402-403	DUAL/ SHIELDED 404-405
PATIENT, HOLTER & TELEMETRY CABLES (continued)			
BURDICK/SIEMENS E350, E350 I, E550, E560, EK-10, ECLIPSE LE, ECLIPSE LEI, ELITE & ELITE II		KKB003	
BURDICK/SIEMENS MA521 • Leadwire sets also available, see pages 408-419.			KCC034
BURDICK/SIEMENS MEDIC 3, MEDIC 4 & MEDIC 5 • Leadwire sets also available, see pages 408-419.	KCB002	KCA001	KCC003 ¹ KEC010 ²
BURDICK/SIEMENS SIRECUST 630 & SIRECUST DU • Leadwire sets also available, see pages 408-419.	KCB002	KCA001	KCC003
CAMBRIDGE VS-1, VS-2 & VS-3		KEB014 ³	
COLIN MED. INST. BP 308, BP 308E, BP 408 & CMB 3000 • Leadwire sets also available, see pages 408-419.		KCA004	
COROMETRICS 115, 116, 118 & 151 ^ KCD033 (Patient Cable - 3 Lead Multi-Link [®]), see page 405. • Leadwire sets also available, see pages 408-419.			KCD033^
COROMETRICS 505, 506, 515 & 515A • Leadwire sets also available, see pages 408-419.		KCA013	
COROMETRICS 556 • Leadwire sets also available, see pages 408-419.	KCB002	KCA001	
CRITICARE SYS. 1100 & 1508		KEB012	
CRITICARE SYS. 504 US • Leadwire sets also available, see pages 408-419.		KCA004	
CRITICARE SYS. 602-A USP & POET 2 • Leadwire sets also available, see pages 408-419.	KCB002	KCA001	KCC003 ¹ KEC010 ²
CRITIKON INC. 8700 SERIES, 9700 SERIES, DINAMAP, DINAMAP PLUS, DINAMAP PRO & DINAMAP MPS • Leadwire sets also available, see pages 408-419.	KCB008	KCA007	KCC009
DATAMEDIX SEE ELECTRODYNE/BECTON DICKINSON/DATAMEDIX/PPG			
DATASCOPE 2000 (RESP), 2001 (RESP), 2002 (RESP), 2100 (RESP), 2200 (RESP), EL (RESP) & PASSPORT (RESP) • Leadwire sets also available, see pages 408-419.	KCB002	KCA001	KCC003
DATASCOPE 2000 (ECG), 2001 (ECG), 2002 (ECG), 2100 (ECG), 2200 (ECG), 3000, BALLOON PUMP, MD-3, MD-3A, MD-4, PASSPORT (ECG), EL (ECG), PASSPORT XG, PASSPORT IL, PASSPORT XL, SPECTRUM, SYS 82, SYS 83, SYS 90, SYS 90T, SYS 97 & TRIO • Leadwire sets also available, see pages 408-419.		KCA016	
DATASCOPE TELEMETRY 3 LEAD ^ KCB028 (Telemetry cable), see page 406.	KCB028^		
DATASCOPE TELEMETRY 4 LEAD ^ KCB002 (Telemetry cable), see page 407.	KDB002^		
DATASCOPE TELEMETRY 5 LEAD ^ KEB015 (Telemetry cable), see page 407.	KEB015^		
DATEX 245P, AESPIRE, AS/3, AS/3 COMPACT, CARDIOCAP I, CARDIOCAP II, CS/3, S/5, S/5 COMPACT, S/5 LIGHT & SATELLITE PLUS • Leadwire sets also available, see pages 408-419.			KCC034 ¹ KEC010 ²

(continued)

Patient, Holter & Telemetry Cables

PATIENT CABLE TYPE Found on Page #'s	FIXED 400-401	DIN/ UNSHIELDED 402-403	DUAL/ SHIELDED 404-405
---	------------------	-------------------------------	------------------------------

PATIENT, HOLTER & TELEMETRY CABLES (continued)

DMI 3 CH RECORDER ^ <i>KGA001 (Holter cable), see page 406.</i> • Leadwire sets also available, see pages 408-419.		KGA001 [^]	
ELECTRODYNE/BECTON DICKINSON/ DATAMEDIX/PPG MD3A • Leadwire sets also available, see pages 408-419.			KEC010
ELECTRODYNE/BECTON DICKINSON/ DATAMEDIX/PPG GUARDIAN 1001 & GUARDIAN N1001 • Leadwire sets also available, see pages 408-419.	KCB002	KCA001	KCC003 ¹ KEC010 ²
GE MEDICAL SEE MARQUETTE/GE MEDICAL			
HEWLETT PACKARD/AGILENT/ZYMED/ PHILIPS MEDICAL DEFIBRILLATOR (12 PIN): M3500B & M5500B • Leadwire sets also available, see pages 408-419.		KCA010 ¹ KEA005 ²	KCC012 ¹ KEC007 ²
HEWLETT PACKARD/AGILENT/ZYMED/ PHILIPS MEDICAL DEFIBRILLATOR (8 PIN): M3500B & M5500B • Leadwire sets also available, see pages 408-419.		KCA022 ^{1 4 5} KCA025 ^{1 5} KEA017 ^{2 5}	
HEWLETT PACKARD/AGILENT/ZYMED/ PHILIPS MEDICAL C3 BEDSIDE MONITOR: 862474, 862475, 862478, 862479 & M1205A; CODEMASTER XL & DEFIBRILLATOR (12 PIN): M1722A & M1722B; DEFIBRILLATOR: M3535A & M3536A; ECG MODULE: M1001B, M1002A & M1002B; ECG MONITOR: 78352C (12 PIN), M1001A, M1165A, M1166A & M1167A; INTELL/VUE: M8001A MP20, M8002A MP30, M8003A MP40, M8004A MP50, M8005A MP60, M8007A MP70 & M8010A MP90; MERLIN CMS: M1175A; MMS PATIENT MONITOR: M3001A; NEONATAL MONITOR: 78834C; TELEMETRY MONITOR: M2601A; VERIDIA CMS: M1177A; VERIDIA PATIENT MONITOR: M3000A, M3046A & M4375A • Leadwire sets also available, see pages 408-419.		KCA010 ¹ KEA005 ²	KCC012 ¹ KEC007 ²
HEWLETT PACKARD/AGILENT/ZYMED/ PHILIPS MEDICAL CODEMASTER XL & DEFIBRILLATOR (8 PIN): M1723A & M1723B; DEFIBRILLATOR: 43100A (8 PIN), 43110A (8 PIN), 43110M, 43110MC, 43120A (8 PIN), 43200A, 78619A, 78620A, 78660A, 78660B, 78661A, 78661B, 78670A, 78671A; ECG MODULE: 78211A (8 PIN); ULTRASOUND: 77000A, 77020A, 77020AC, 77020AR, 77030A, 77035A, 77040A, M2400A, M2406A, M2475A (8 PIN), M2475B, SONOS 500, SONOS 4500, SONOS 5500, SONOS 7506 & 77025A SONOS • Leadwire sets also available, see pages 408-419.		KCA022 ^{1 4 5} KCA025 ^{1 5} KEA017 ^{2 5}	
HEWLETT PACKARD/AGILENT/ZYMED/ PHILIPS MEDICAL CODEMASTER XL & DEFIBRILLATOR (8 PIN): M1722A & M1722B; DEFIBRILLATOR (8 PIN): M3500B + M5500B; ECG MODULE: 78208A & 78210A; ECG MONITOR: 778330A, 78331A, 78332A, 78333A, 78341A, 78342A, 78345A, 78346A, 78351A, 78352A (8 PIN), 78353A, 78353B, 78354A, 78532A, 78532B, 78534A, 78534B & 78534C • Leadwire sets also available, see pages 408-419.		KCA022 ^{1 4 5} KCA025 ^{1 5} KEA017 ^{2 5}	
HEWLETT PACKARD/AGILENT/ZYMED/ PHILIPS MEDICAL DEFIBRILLATOR (6 PIN): 43100A, 43110A, 43120A & M3921A; PORTABLE PATIENT MONITOR: M3921A • Leadwire sets also available, see pages 408-419.	KCB002	KCA001	KCC003

¹ 3 Leadwire Patient Cable ² 5 Leadwire Patient Cable ³ Old RPI Part #BUC009
⁴ Old RPI Part #HPC008 ⁵ Pin colors are White, Green, & Black

PATIENT CABLE TYPE Found on Page #'s	FIXED 400-401	DIN/ UNSHIELDED 402-403	DUAL/ SHIELDED 404-405
---	------------------	-------------------------------	------------------------------

PATIENT, HOLTER & TELEMETRY CABLES (continued)

HEWLETT PACKARD/AGILENT/ZYMED/ PHILIPS MEDICAL EGG MONITOR: 1500A, 1500B, 1504A, 1506A, 1511A & 1511B			KEB030 ⁶
HEWLETT PACKARD/AGILENT/ZYMED/ PHILIPS MEDICAL 10 LEAD FIXED CABLE: M1770A PAGewriter 300Pi, M1771A PAGewriter 200 & M1772A PAGewriter 100			KKB006
HEWLETT PACKARD/AGILENT/ZYMED/ PHILIPS MEDICAL HOLTER MONITOR: Tri-Track 1100-005 & Tri-Track 1100-008 ^ <i>KGA001 (Holter cable), see page 406.</i>			KGA001 [^]
HEWLETT PACKARD/AGILENT/ZYMED/ PHILIPS MEDICAL 78100A SAFETY TELEMETRY ^ <i>KCB029 (Telemetry cable), see page 406.</i>			KCB029 ^{7 ^}
HEWLETT PACKARD/AGILENT/ZYMED/ PHILIPS MEDICAL M2601A TELEMETRY TRANSMITTER ^ <i>KCB031 (Telemetry cable), see page 406.</i> ^ <i>KCB032 (Telemetry cable), see page 407.</i> ^ <i>KEB018 (Telemetry cable), see page 407.</i> ^ <i>KEB019 (Telemetry cable), see page 407.</i>			KCB031 ^{1 ^} KCB032 ^{1 ^} KEB018 ^{2 ^} KEB019 ^{2 ^}
HEWLETT PACKARD/AGILENT/ZYMED/ PHILIPS MEDICAL 5 LEAD TELEMETRY: DIGITRACK 2020 ^ <i>KEB015 (Telemetry cable), see page 407.</i>			KEB015 [^]
HEWLETT PACKARD/AGILENT/ZYMED/ PHILIPS MEDICAL 4 LEAD TELEMETRY ^ <i>KCB002 (Telemetry cable), see page 407.</i>			KDB002 [^]
HILL ROM SEE AIR SHIELDS/HILL ROM/VICKER/NARCO			
INSTROMEDIX KING OF HEARTS ^ <i>KBB001 (Telemetry cable), see page 406.</i>			KBB001 [^]
INVIVO RESEARCH MILLENNIA, 3500 & 3550 • Leadwire sets also available, see pages 408-419.	KCB002	KCA001	KCC003 ¹ KEC010 ²
INVIVO RESEARCH OMNI-TRACK 300, M6, M12, NVS & TVS • Leadwire sets also available, see pages 408-419.		KCA004	KEC010
IREX SYSTEM III • Leadwire sets also available, see pages 408-419.			KCA013
IREX 880 • Leadwire sets also available, see pages 408-419.	KCB008	KCA007	KCC009
IVY BIOMEDICAL 101 (Before 1989), 402, 700 & 3100 • Leadwire sets also available, see pages 408-419.	KCB002	KCA001	KCC003
KERNS & WHITE KEC-56 • Leadwire sets also available, see pages 408-419.			KCA013
LASER SYSTEMS VISTA1 • Leadwire sets also available, see pages 408-419.	KCB002	KCA001	KCC003
LUMISCOPE 5 LEAD ECG CABLE • Leadwire sets also available, see pages 408-419.			KEA017 ⁵
MARQUETTE/GE MEDICAL 3 CH HOLTER CABLE ^ <i>KGA001 (Holter cable), see page 406.</i> • Leadwire sets also available, see pages 408-419.			KGA001 [^]

⁴ Old RPI Part #HPC004 ⁵ Old RPI Part #HPC006 ⁶ Old RPI Part #HPC005
⁷ Pin colors are White, Red, & Black

(continued)

PATIENT CABLE TYPE Found on Page #'s	FIXED 400-401	DIN/ UNSHIELDED 402-403	DUAL/ SHIELDED 404-405
PATIENT, HOLTER & TELEMETRY CABLES (continued)			
MARQUETTE/GE MEDICAL 900 DEFIB SERIES, 1200 DEFIB SERIES, & 1500 DEFIB SERIES • Leadwire sets also available, see pages 408-419.	KCB008 ¹ KEB012 ²	KCA007	KCC009
MARQUETTE/GE MEDICAL 1200 ST, HELLIGE MICROSMART, MAC 1200 & MAC 1600	KKB012		
MARQUETTE/GE MEDICAL APEXPRO TELEMETRY UNITS • Leadwire sets also available, see pages 408-419.			
MARQUETTE/GE MEDICAL CASE, CASE 8000, MAC 5000 & MAC 5000 ST ^ GEC020 (Acquisition Module cable), see page 405. • Leadwire sets also available, see pages 408-419.	GEC021^		
MARQUETTE/GE MEDICAL CASE 12, CASE 15, CASE 16, CENTRA, MAC 6, MAC 8, MAC 12, MAC PC, MAC VU & MAX-PERSONAL ^ GEC020 (Acquisition Module cable), see page 405.	GEC020^		
MARQUETTE/GE MEDICAL DASH 2000 PRO, DASH 3000 PRO, DASH 4000 PRO, DINAMAP PRO 100, EAGLE SYSTEMS, MAC-LAB, SOLAR 3000, SOLAR 8000, SOLAR 9500, TRAM 100, TRAM 200, TRAM 300, TRAM 400, TRAM 500, TRAM 600, TRAM 800, TRAM AR & UNITY SYSTEMS ^ KED021 (Patient Cable - 5 Lead Multi-Link®), see page 405. • Leadwire sets also available, see pages 408-419.		KCA019 ¹ KEA001 ²	KCC021 ¹ KEC003 ² KED021 ² ^
MARQUETTE/GE MEDICAL HELLIGE EK-51	KKB007		
MATRIX MEDICAL LIFE DEFENSE PLUS (DEFIB) • Leadwire sets also available, see pages 408-419.	KCB002	KCA001	KCC003
MDE SEE MEDICAL DATA ELEC.			
MEDICAL DATA ELEC. (MDE) 400673	KCB008		
MEDICAL DATA ELEC. (MDE) ESCORT 100, ESCORT 101, ESCORT 102, ESCORT 200, ESCORT 300 & PRISM (WITHOUT 90° CONNECTOR) • Leadwire sets also available, see pages 408-419.	KCB002	KCA001	KCC003
MEDICAL DATA ELEC. (MDE) ESCORT W/ HP OPTION • Leadwire sets also available, see pages 408-419.		KCA010 ¹ KEA005 ²	KCC012 ¹ KEC007 ²
MEDICAL DATA ELEC. (MDE) 3 LEAD TELEMETRY ^ KCB028 (Telemetry cable), see page 406.	KCB028^		
MEDICAL DATA ELEC. (MDE) 5 LEAD TELEMETRY ^ KEB015 (Telemetry cable), see page 407.	KEB015^		
MEDICAL RESEARCH LABS 260SL, 450SL, 521A, PRE-AMP 450, PORTAPAK 80, PORTAPAK 90 & PORTAPAK 1000 ISOLATED • Leadwire sets also available, see pages 408-419.	KCB002	KCA001	KCC003
MEDTRONIC SEE PHYSIO CONTROL/MEDTRONIC			
MENNEN MEDICAL TELEMETRY 4 LEAD ^ KDB002 (Telemetry cable), see page 407.	KDB002^		
MENNEN MEDICAL TELEMETRY 5 LEAD ^ KEB015 (Telemetry cable), see page 407.	KEB015^		
MIDMARK IQ MARK ^ KEB020 (Holter cable), see page 406.	KEB020^		

¹ 3 Leadwire Patient Cable ² 5 Leadwire Patient Cable ³ Old RPI Part #BUC009
⁴ Old RPI Part #HPC008 ⁵ Pin colors are White, Green, & Black

PATIENT CABLE TYPE Found on Page #'s	FIXED 400-401	DIN/ UNSHIELDED 402-403	DUAL/ SHIELDED 404-405
PATIENT, HOLTER & TELEMETRY CABLES (continued)			
MINDRAY BENEVIEW T5, BENEVIEW T6, BENEVIEW T8 & MPM MODULE • Leadwire sets also available, see pages 408-419.		KEA005	KEC007
MORTARA INC. ELI 250	KKB007		
MTM 2 CH HOLTER CABLE ^ KEA004 (Holter cable), see page 406. • Leadwire sets also available, see pages 408-419.		KEA004^	
MTM 3 CH HOLTER CABLE ^ KGA001 (Holter cable), see page 406. • Leadwire sets also available, see pages 408-419.		KGA001^	
NARCO SEE AIR SHIELDS/HILL ROM/VICKER/NARCO			
NELLCOR/PURTAN BENNET 791018, MBP-4000, N-200, N-250 & N-1000 • Leadwire sets also available, see pages 408-419.	KCB002	KCA001	KCC003 ¹ KEC010 ²
NIHON KODEN ECG: 5151A, 5403A, 6151A, 6306A, 6353A, 6543A, 6551A, 7514A, 8110A, 8240A, 8330A, 8350A, 8370A & 9340A	KKB002		
NIHON KODEN BSM-8301A, BSM-8302, BSM-8500A, BSM-8502, OEC-5102A (Serial#20156), OEC-6105A (Serial#>22026), OEC-7102A, OEC-8108, TEC-5200A, TEC-7100A, TEC-7200A, TEC-7300A & 8000 SERIES (DEFIB) • Leadwire sets also available, see pages 408-419.		KCA004	KEC010
NORTH AMERICAN DRAEGER VITALERT 1000 & VITALERT 2000 • Leadwire sets also available, see pages 408-419.		KCA004	KEC010
NOVAMATRIX MED LIFE DEFENSE 1 • Leadwire sets also available, see pages 408-419.		KCA004	KEC010
PACE TECH MINIMAX 4000CL, MINIPACK 300, MINIPACK 3000, MINIPACK 3100, VITALMAX 2100, VITALMAX 2200, VITALMAX 4000, VITALMAX 4000CL, VITALMAX 4100 & VITALMAX 800 PLUS • Leadwire sets also available, see pages 408-419.	KCB002	KCA001	KCC003
PARKS ELECTRONICS 2 CH HOLTER CABLE ^ KEA004 (Holter cable), see page 406. • Leadwire sets also available, see pages 408-419.		KEA004^	
PC SCIENTIFIC 2 CH HOLTER CABLE 3 CH HOLTER CABLE ^ KEA004 (Holter cable), see page 406. ^^ KGA001 (Holter cable), see page 406. • Leadwire sets also available, see pages 408-419.		KEA004^ KGA001^^	
PHILIPS MEDICAL SEE HEWLETT PACKARD/AGILENT/ZYMED/PHILIPS MEDICAL			
PHYSIO CONTROL/MEDTRONIC LIFEPAK 6	KEB012		
PHYSIO CONTROL/MEDTRONIC LIFEPAK 12 & LIFEPAK 20 • Leadwire sets also available, see pages 408-419.	KCB036	KCA035	
PHYSIO CONTROL/MEDTRONIC LIFEPAK 5, LIFEPAK 7, LIFEPAK 8, LIFEPAK 9, LIFEPAK 10, LIFEPAK 510, VSM-1, VSM-2, VSM-2ESF & VSM-3 W/O RESISTORS • Leadwire sets also available, see pages 408-419.	KCB008 ¹ KEB012 ²	KCA007	KCC009

¹ Old RPI Part #HPC004 ² Old RPI Part #HPC006 ³ Old RPI Part #HPC005
⁴ Pin colors are White, Red, & Black

(continued)

Patient, Holter & Telemetry Cables

PATIENT CABLE TYPE Found on Page #'s	FIXED 400-401	DIN/ UNSHIELDED 402-403	DUAL/ SHIELDED 404-405
---	------------------	-------------------------------	------------------------------

PATIENT, HOLTER & TELEMETRY CABLES (continued)

PIC SEE ACCUCORE/PIC/VITAL.COM			
PPG SEE ELECTRODYNE/BECTON DICKINSON/DATAMEDIX/PPG			
PROTOCOL SYS./WELCH ALLYN PROPAQ 206 EL (HP OPTION) • Leadwire sets also available, see pages 408-419.			KCC012 ^① KCA010 ^②
PROTOCOL SYS./WELCH ALLYN 6200, ATLAS, ENCORE, PROPAQ 102, PROPAQ 103, PROPAQ 104, PROPAQ 106, PROPAQ CS & ULTRASMART • Leadwire sets also available, see pages 408-419.	KCB002	KCA001	KCC003
PURTAN BENNET SEE NELLCOR/PURTAN BENNET			
QUINTON Q-STRESS ^ KKB010 (Patient Cable - 10 Lead Fixed Pinch), see page 401. ^^ KKB011 (Patient Cable - 10 Lead Fixed Snap), see page 401.	KKB010^ KKB011^^		
QUINTON Q-TEL 3LD TELEMETRY ^ KCB028 (Telemetry cable), see page 406.	KCB028^		
QUINTON Q-TEL 4LD TELEMETRY ^ KDB002 (Telemetry cable), see page 407.	KDB002^		
QUINTON 365 ^ KEB015 (Telemetry cable), see page 407.	KEB015^		
ROZINN ELECTRONICS 151 3 CH 7 LD ^ KGA001 (Holter cable), see page 406. • Leadwire sets also available, see pages 408-419.		KGA001^	
ROZINN ELECTRONICS 151 3 CH 5 LD ^ KEA004 (Holter cable), see page 406. • Leadwire sets also available, see pages 408-419.		KEA004^	
SCHILLER 3 CH HOLTER ^ KGA001 (Holter cable), see page 406. • Leadwire sets also available, see pages 408-419.		KGA001^	
SCHILLER AT-1, AT-2, AT-2 PLUS & AT-10	KKB007		
SIEMENS SEE BURDICK/SIEMENS			
SIMONSEN & WELLS 3 LD TELEMETRY ^ KCB028 (Telemetry cable), see page 406.	KCB028^		
SIMONSEN & WELLS 4 LD TELEMETRY ^ KDB002 (Telemetry cable), see page 407.	KDB002^		
SIMONSEN & WELLS 8000 (New Generation), Athena, Diascope 1 & Diascope 2 • Leadwire sets also available, see pages 408-419.			KCC034
SPACE LABS ULTRAVIEW MONITORS (90496) • Leadwire sets also available, see pages 408-419.			KEC016
SPACE LABS 900 RESP W/O RESISTORS	KEB012		
SPACE LABS 400 Series, 500 Series, 900 Series, 701S, 703S, 720S, 4045, 90408, 90418, 90470, 90600 Series, 90700 SERIES, TEK-413, TEK-414, TEK-511, TEK-512, TEK-514 & TEK-521 • Leadwire sets also available, see pages 408-419.		KCA004	KEC010

PATIENT CABLE TYPE Found on Page #'s	FIXED 400-401	DIN/ UNSHIELDED 402-403	DUAL/ SHIELDED 404-405
---	------------------	-------------------------------	------------------------------

PATIENT, HOLTER & TELEMETRY CABLES (continued)

TEMTECH LIFEGUARD 9, M401, M501 & M503	KEB012		
VICKER SEE AIR SHIELDS/HILL ROM/VICKER/NARCO			
VITAL.COM SEE ACCUCORE/PIC/VITAL.COM			
WELCH ALLYN SEE PROTOCOL SYS./WELCH ALLYN			
ZOLL D-90, M SERIES, PD-1200, PD-1400, PD-1600 & PD-2000 • Leadwire sets also available, see pages 408-419.	KCB002	KCA001	
ZYMED SEE HEWLETT PACKARD/AGILENT/ZYMED/PHILIPS MEDICAL			

① 3 Leadwire Patient Cable
⑦ Old RPI Part #HPC008

② 5 Leadwire Patient Cable
⑧ Pin colors are White, Green, & Black

③ Old RPI Part #BUC009

④ Old RPI Part #HPC004
⑨ Pin colors are White, Red, & Black

⑤ Old RPI Part #HPC006

⑥ Old RPI Part #HPC005

RPI Part #BUK041
OEM Part #844842

LEAD SELECTOR KNOB

- Size: ~1.13" OD x .77" lg.
 - Shaft size: 1/4"
 - Includes: Set screws
- Fits:** Control Panel
Models: EK-5 & EK-5A

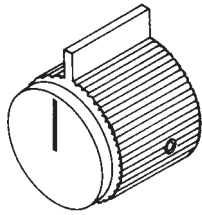

RPI Part #BUK042
OEM Part #844845

SENSITIVITY KNOB

- Size: ~.91" OD x .64" lg.
 - Shaft size: 1/4"
 - Includes: Set screws
- Fits:** Control Panel
Models: EK-5 & EK-5A

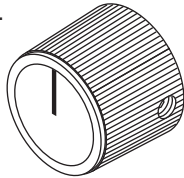

RPI Part #BUK043
OEM Part #844846

POSITION CONTROL KNOB

- Size: ~.72" OD x .58" lg.
 - Shaft size: 1/4"
 - Includes: Set screws
- Fits:** Control Panel
Models: EK-5 & EK-5A

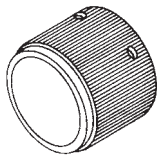

RPI Part #CAF011
OEM Part # 850404

RUBBER FOOT

- 4 per package
- Material: Black rubber with molded in steel washer
- Size: ~.75" OD x .50" lg.; #10 clearance hole

Fits: Base Plate

Models: EK-5, EK-5A, EK-6, EK-7, EK-8 & EK-670; DC-185, DC-190, E600, E500TW, MC-600 & TMS-302



RPI Part #BUR011
OEM Part #860405

DRIVE ROLLER

Fits: Back Plate and Center Plate
Models: EK-5 & EK-5A

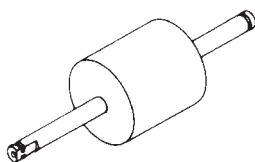

RPI Part #BUB012
OEM Part #850402
Industry Part #80XL025

TIMING DRIVE BELT

Fits: Drive Pulley
Models: EK-5 & EK-5A

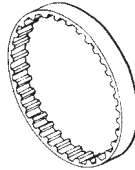

RPI Part #BUB013
OEM Part #850502
Industry Part #130XL025

TIMING BELT

Fits: Drive Pulley
Models: E100, E200, E310, E320, EK-8 & EK-670 (Serial #5999 and below)

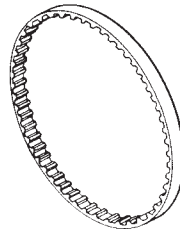

RPI Part #BUB014
OEM Part #850557
Industry Part #140XL025

TIMING BELT

Fits: Drive Pulley
Model: EK-670 (Serial #6000 and above)

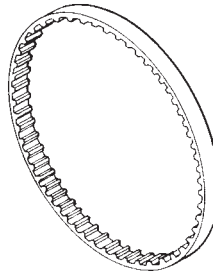

RPI Part #BUB027
OEM Part #833028

CIRCUIT BREAKER

- 0.5A@250VAC; 28VDC
 - Includes: Mounting hardware
- Fits:** Power Panel
Model: EK-5A

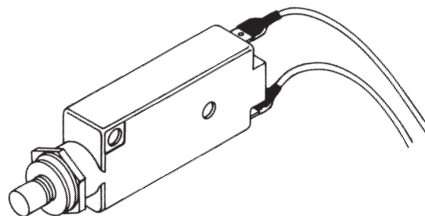

RPI Part #BUS005
OEM Part #860344

RECORD STYLUS

Fits: Galvanometer Assembly
Models: EK-3 & EK-4

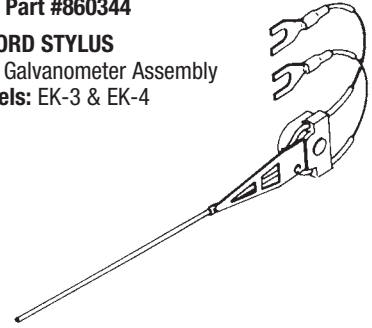

RPI Part #BUS006
OEM Part #860289

MARKING STYLUS

Fits: Recording Assembly
Model: EK-3

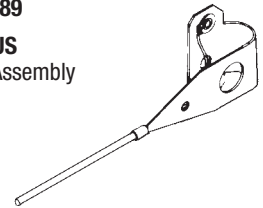

RPI Part #BUS007
OEM Part #860343

MARKING STYLUS

Fits: Recording Assembly
Model: EK-4

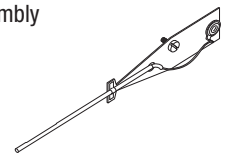

RPI Part #BUS008
OEM Part #860496

RECORD STYLUS

Fits: Galvanometer Assembly
Models: EK-5, EK-5A & EK-6

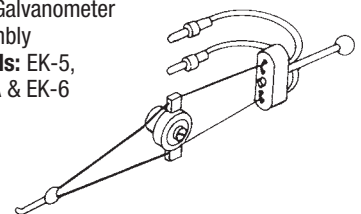

RPI Part #BUS025
OEM Part #861099

RECORD STYLUS

Fits: Galvanometer Assembly
Models: E100, E200, E310, E320, EK-7, EK-8 & EK-670

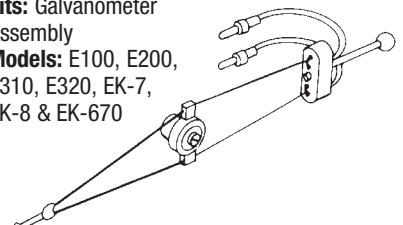

General Biomedical Equipment

Models: Atria 3000, DC Series, E Series, Eclipse Series, EK Series, Elite, MC Series, Medic Series, MW Series, PA Series, Sirecust Series, TMS Series & UT Series

RPI Part #BUT034
OEM Part #860497

TRANSDUCER ELEMENT
Fits: Galvanometer Assembly
Models: EK-5 & EK-5A

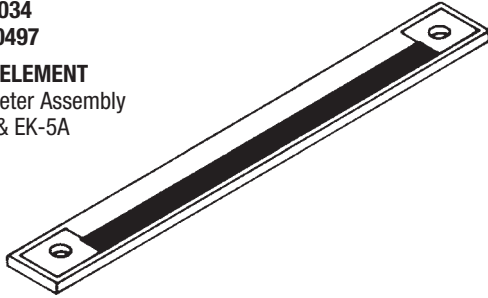

RPI Part #BUC028
OEM Part #813004

CAPACITOR
• 1000 MFD, 25VDC electrolytic
Fits: Chassis
Model: EK-5A

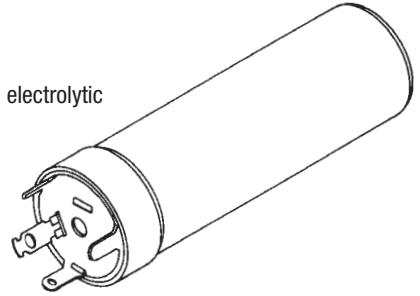

RPI Part #BUS030
OEM Part #827785

POWER SWITCH
• DPST
• 6A@125VAC;
3A@250VDC
• Includes: Mounting hardware
Fits: Control Panel
Models: DC-180, DC-185,
EK-5 & EK-5A

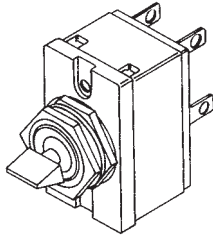

RPI Part #BUS032
OEM Part #827795

MARKER SWITCH
• Normally Open
• 3A@125VAC; 4A@14VDC
• Includes: Mounting hardware
Fits: Control Panel
Models: DC-175,
DC-195, EK-5A,
PA-100, PA-101,
PA-104 & PA-107

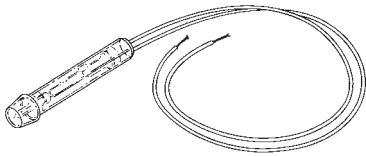
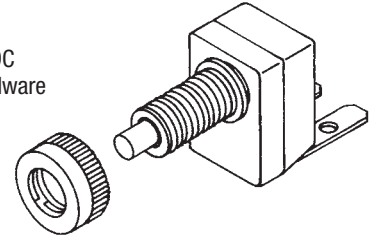

RPI Part #BUL026
OEM Part #831742

PILOT LIGHT (RED)
• 125VAC, 1/2W
Fits: Control Panel
Model: EK-5A

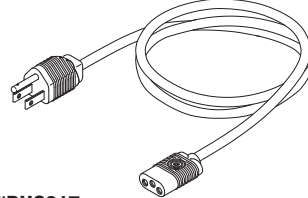

RPI Part #BUC017
OEM Part #097152

POWER CORD
• Length: ~8 ft.
• 18/3 SJT, 60°C; 7A@125VAC
• Plug Type: NEMA 5-15P
• Connector Type: BMI-3
• Color: Gray
Fits: AC Connector
Models: EK-1, EK-2, EK-3, EK-4,
EK-5, EK-5A & EK-8

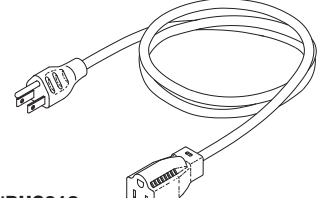

RPI Part #BUC018
OEM Part # (No OEM Part # Available)

EXTENSION CORD
• Length: ~8 ft.
• 16/3 SJT, 60°C; 13A@125VAC
• Plug Type: NEMA 5-15P
• Connector Type: NEMA 5-15R
• Color: Black
Fits: AC Connector
Models: Diathermy: MW200 & MW225;
Ultrasound: UT420 & UT4300

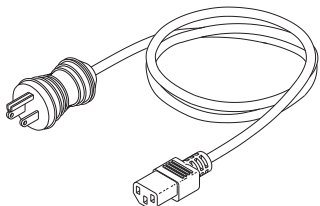

RPI Part #RPC557
OEM Part # (No OEM Part # Available)

HOSPITAL GRADE POWER CORD
• Length: ~8 ft.
• 16/3 SJT, 60°C; 13A@125VAC
• Plug Type: NEMA 5-15P
• Connector Type: EN60320-C13
• Color: Cool gray
Fits: Power Input Module
Model: EK-10

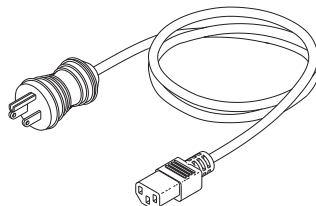

RPI Part #RPC558
OEM Part # (No OEM Part # Available)

HOSPITAL GRADE POWER CORD
• Length: ~18 ft.
• 16/3 SJT, 60°C; 13A@125VAC
• Plug Type: NEMA 5-15P
• Connector Type: EN60320-C13
• Color: Cool gray
Fits: Power Input Module
Model: EK-10

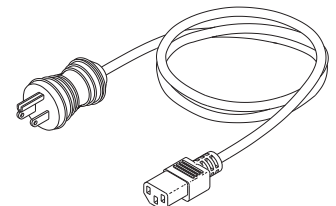

RPI Part #RPC559
OEM Part # (No OEM Part # Available)

HOSPITAL GRADE POWER CORD
• Length: ~25 ft.
• 16/3 SJT, 60°C; 13A@125VAC
• Plug Type: NEMA 5-15P
• Connector Type: EN60320-C13
• Color: Cool gray
Fits: Power Input Module
Model: EK-10

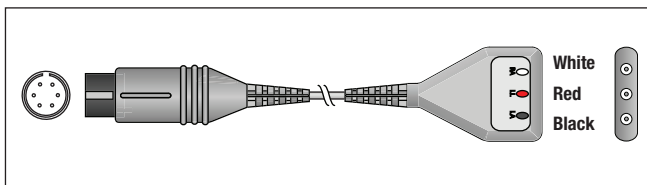

RPI Part #KCA001
OEM Part # (No OEM Part # Available)

PATIENT CABLE - 3 LEAD DIN

- Number of leads: 3
 - Length: ~10 ft.
 - Equipment End: 6-Pin; 1K Ω Resistors; Jumper E to C
 - Patient End: Din/Unshielded; .060" Pin (Safety)
 - Color: White, Red, and Black
 - Also available: Leadwire Adapter Kit (RPI Part #LAK001)
 - Suggested Leadwire Sets: Reusable Leadwire Sets (RPI Part #'s LKM002 and LKM005), Disposable Leadwire Sets (RPI Part #'s LDM301 and LDM308), and Veterinary Leadwire Set (RPI Part #LVM701)
- Models:** Medic 3, Medic 4, Medic 5, Sirecust 630 & Sirecust DU

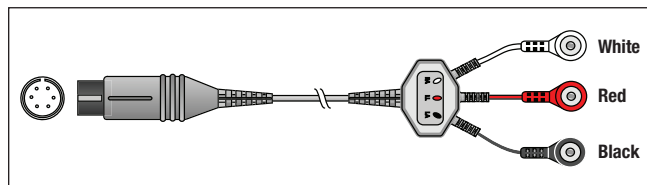

RPI Part #KCB002
OEM Part # (No OEM Part # Available)

PATIENT CABLE - 3 LEAD FIXED SNAP

- Number of leads: 3
 - Length: ~11 ft.
 - Equipment End: 6-Pin; 1K Ω Resistors; Jumper E to C
 - Patient End: Fixed Snap
 - Color: White, Red, and Black
- Models:** Medic 3, Medic 4, Medic 5, Sirecust 630 & Sirecust DU

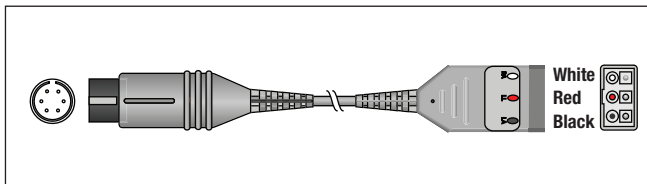

RPI Part #KCC003
OEM Part # (No OEM Part # Available)

PATIENT CABLE - 3 LEAD DUAL

- Number of leads: 3
 - Length: ~10 ft.
 - Equipment End: 6-Pin; 1K Ω Resistors; Jumper E to C
 - Patient End: Dual/Shielded; .060" Pin (Safety)
 - Color: White, Red, and Black
 - Suggested Leadwire Sets: Reusable Leadwire Sets (RPI Part #'s LKM014 and LKM017), Disposable Leadwire Sets (RPI Part #'s LDM305 and LDM312), and Veterinary Leadwire Set (RPI Part #LVM705)
- Models:** Medic 3, Medic 4, Medic 5, Sirecust 630 & Sirecust DU

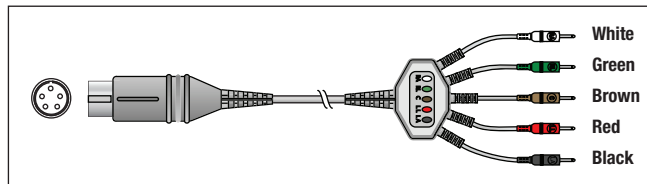

RPI Part #KEB014
OLD RPI Part #BUC009
OEM Part # (No OEM Part # Available)

PATIENT CABLE - 5 LEAD FIXED PIN

- Number of leads: 5
 - Length: ~8 ft.
 - Equipment End: 5-Pin
 - Patient End: Fixed .125" Pin
 - Color: White, Green, Brown, Red, and Black
 - Also available: Leadwire Adapter Kit (RPI Part #LAK001)
- Models:** EK-1, EK-2, EK-3, EK-4, EK-5 & EK-5A

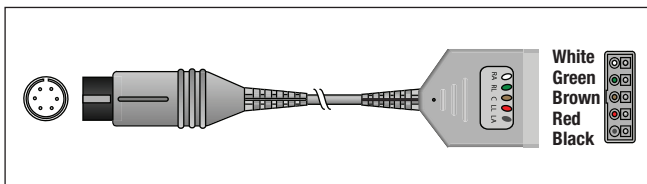

RPI Part #KEC010
OEM Part # (No OEM Part # Available)

PATIENT CABLE - 5 LEAD DUAL

- Number of leads: 5
 - Length: ~10 ft.
 - Equipment End: 6-Pin; 1K Ω Resistors
 - Patient End: Dual/Shielded; .060" Pin (Safety)
 - Color: White, Green, Brown, Red, and Black
 - Suggested Leadwire Sets: Reusable Leadwire Sets (RPI Part #'s LKM032 and LKM035), Disposable Leadwire Sets (RPI Part #'s LDM307 and LDM314), and Veterinary Leadwire Set (RPI Part #LVM707)
- Models:** Medic 3, Medic 4 & Medic 5

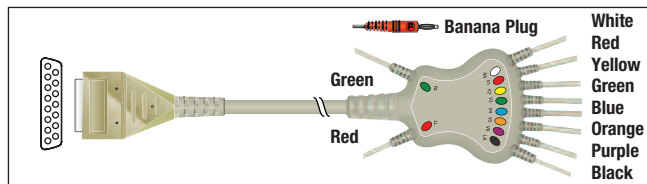

RPI Part #KKB003
OEM Part # (No OEM Part # Available)

PATIENT CABLE - 10 LEAD FIXED BANANA

- Number of leads: 10
 - Length: ~10 ft.
 - Equipment End: 15-Pin D-Sub
 - Patient End: Fixed Banana Plug
 - Color: White, Red, Yellow, Green, Blue, Orange, Purple, and Black
 - Also available: Leadwire Adapter Kit (RPI Part #LAK001)
- Models:** E350, E350 I, E550, E560, Eclipse, Eclipse LE, Eclipse LEI, Elite, Elite II & EK-10

(Continued on next page)

General Biomedical Equipment

Models: Atria 3000, DC Series, E Series, Eclipse Series, EK Series, Elite, MC Series, Medic Series, MW Series, PA Series, Sirecust Series, TMS Series & UT Series

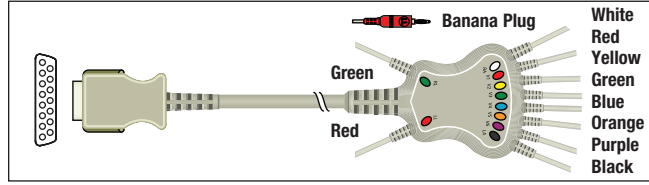

RPI Part #KKB008
OEM Part # *(No OEM Part # Available)*
PATIENT CABLE - 10 LEAD FIXED BANANA

- Number of leads: 10
 - Length: 10 ft.
 - Equipment End: 15-Pin D-Sub; 10K Ω Resistors
 - Patient End: Fixed Banana Plug
 - Color: White, Red, Yellow, Green, Blue, Orange, Purple, and Black
 - Also available: Leadwire Adapter Kit (RPI Part #LAK001)
- Model:** Atria 3000, Eclipse 4, Eclipse 400, Eclipse 8, Eclipse 800, Eclipse 850, Eclipse LE II & Plus

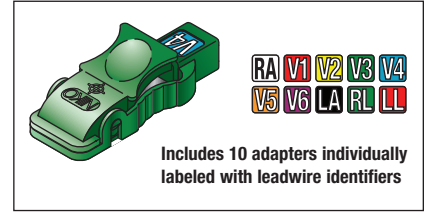

RPI Part #LAK001
OEM Part # *(No OEM Part # Available)*

LEADWIRE ADAPTER KIT

- Includes: 10 adapters individually labeled with leadwire identifiers
- Adapts banana plugs or pins to tab or snap electrodes
- Widest contact area for superior trace quality
- Flat, wide bodied design helps prevent twisting
- Durable construction - built to last

Model: Burdick: Atria 3000, E350, E350 I, E550, E560, Eclipse, Eclipse 4, Eclipse 400, Eclipse 8, Eclipse 800, Eclipse 850, Eclipse LE, Eclipse LEI, Eclipse LE II, Eclipse Plus, EK-1, EK-2, EK-3, EK-4, EK-5, EK-5A, EK-10 & Elite

NOTES:

RPI Part #GEP004
OEM Part #320413

PUMP ASSEMBLY

- Includes: Tubing (RPI Part #RPT645), Barbed Elbow Fitting (RPI Part #RPF641), Check Valve (RPI Part #RPV642), mounting bracket, hardware, pump and wire harness

Fits: Chassis

Models: Dinamap 8100, 8100T, 9300 & 9340

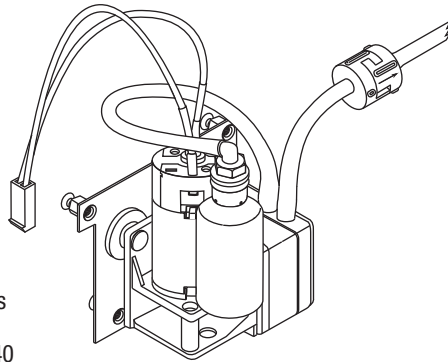

RPI Part #RPT645
OEM Part #740107

TUBING

- 1/8" ID x 1/4" OD
- Opaque Beige
- Blended Silicone
- Sold by the foot (Reel not included)
- USP class VI certified
- Temperature rated: -75 to 275°F; maximum pressure: 19 PSI
- Autoclavable

Fits: Pump Assembly

Models: Dinamap 8100, 8100T, 9300 & 9340

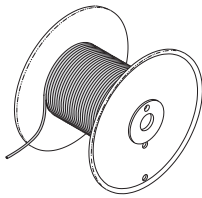

RPI Part #RPV642
OEM Part # 754116

CHECK VALVE

- 1/8" Barbs
- Polypropylene
- Cracking pressure: 0.11 PSI

Fits: Pump Assembly

Models: Dinamap 8100, 8100T, 9300 & 9340

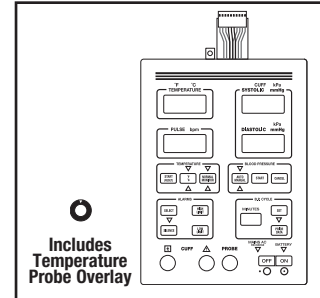
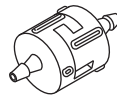

Includes Temperature Probe Overlay

RPI Part #GEK001
OEM Part #300918

FRONT PANEL OVERLAY - 8100T

- Includes: Temperature probe overlay

Fits: Front Panel

Model: Dinamap 8100T

RPI Part #GEK002
OEM Part #701252

FRONT PANEL OVERLAY - 8100

Fits: Front Panel

Model: Dinamap 8100

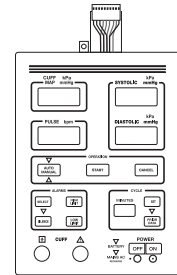

RPI Part #GEC009
OEM Part #316339

TEMPERATURE PROBE CONNECTOR

- Includes: Temperature probe overlay, 1/2" retaining ring and (1 piece) 4" White Cable Tie (RPI Part #RPT083)

• Wires to board

Fits: Case Bracket

Model: Dinamap 8100T

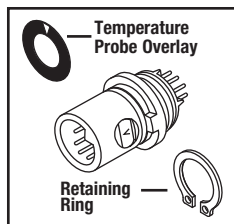
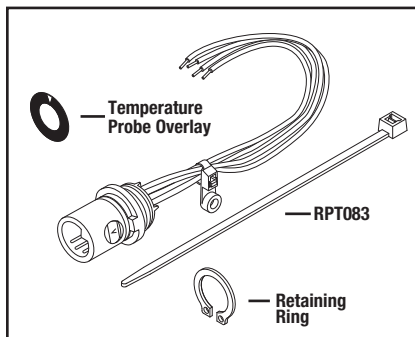

RPI Part #GEC008
OEM Part #300681

TEMPERATURE PROBE CONNECTOR

- Includes: Temperature probe overlay and 1/2" retaining ring

• Board mounted

Fits: Display PCB

Model: Dinamap 8100T

RPI Part #GEP014
OEM Part #320438

CALIBRATION PLUG

- 6,090Ω ± 1% between pins 3 and 6

Fits: Temperature Probe Connector

Model: Dinamap 8100T

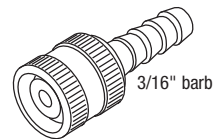
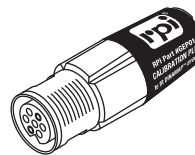

RPI Part #GEC012
OEM Part #754505

QUICK CONNECT (3/16" FEMALE)

- Material: Brass
- 5/16-24 screw connector with a 3/16" barb

• Includes: (1 piece) O-Ring (RPI Part #RP0313)

Fits: Dual Tubing Set

Models: 8100 & 8100T

RPI Part #RP0312
OEM Part #300593
Industry Part #AS568-004

O-RING

- 12 per package
- .070" ID x .210" OD x .070" X-Sec
- Material: Nitrile (Buna N); Duro: 70
- Included in: O-Ring Kit (RPI Part #RPK404)

Fits: Quick Connect (3/16" Female) (RPI Part #GEC012)

Models: 8100 & 8100T



General Biomedical Equipment

Models: DINAMAP™ 8100, 8100T, 8110, 8120, 9300, 9340, 9350, 9400 & 9500XL

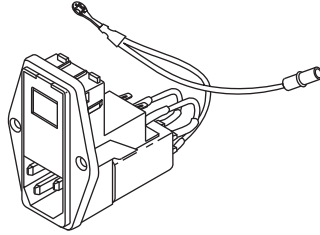

RPI Part #GEM015
OEM Part #320431

POWER INPUT MODULE

- Includes installed fuse holders and (2 pieces) 1/2A @ 250VAC Fuse (RPI Part #RPF043)

Fits: Chassis

Models: Dinamap 8100 & 8100T

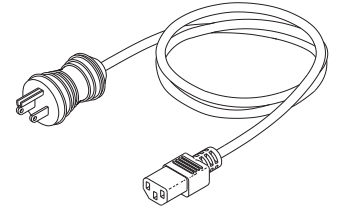

RPI Part #RPC558

OEM Part # (No OEM Part # Available)

HOSPITAL GRADE POWER CORD

- Length: ~18 ft.
- 16/3 SJT, 60°C: 13A@125VAC
- Plug Type: NEMA 5-15P
- Connector Type: EN60320-C13
- Color: Cool gray

Fits: Power Input Module

Models: Dinamap 8100 & 8100T

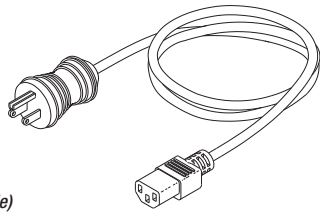

RPI Part #RPC557

OEM Part # (No OEM Part # Available)

HOSPITAL GRADE POWER CORD

- Length: ~8 ft.
- 16/3 SJT, 60°C: 13A@125VAC
- Plug Type: NEMA 5-15P
- Connector Type: EN60320-C13
- Color: Cool gray

Fits: Power Input Module

Models: Dinamap 8100 & 8100T

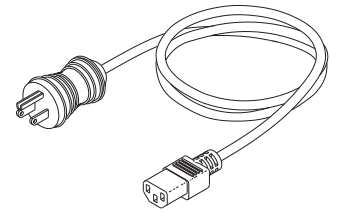

RPI Part #RPC559

OEM Part # (No OEM Part # Available)

HOSPITAL GRADE POWER CORD









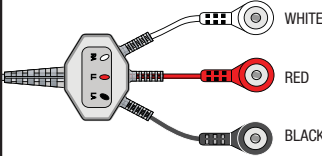

- Length: ~25 ft.
- 16/3 SJT, 60°C: 13A@125VAC
- Plug Type: NEMA 5-15P
- Connector Type: EN60320-C13
- Color: Cool gray

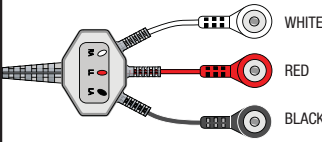
Fits: Power Input Module

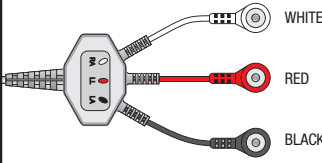
Models: Dinamap 8100 & 8100T

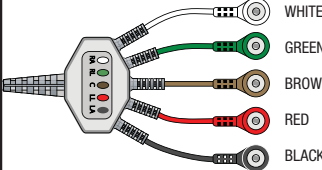
NOTES:

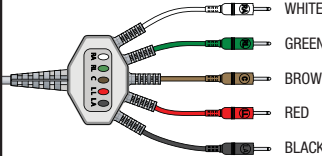
FIXED PATIENT CABLES

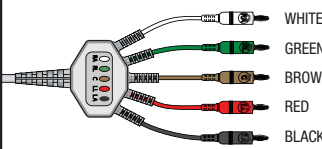
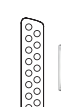
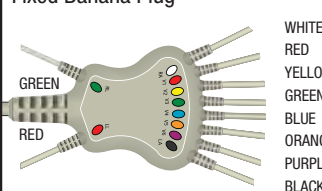









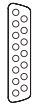

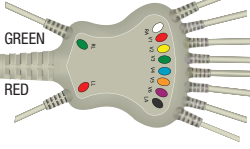

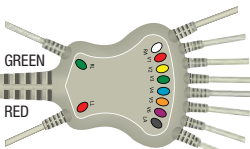
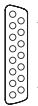
DESCRIPTION	EQUIPMENT END	PATIENT END	NOTES
RPI Part #KCB002 PATIENT CABLE - 3 LEAD FIXED SNAP • Number of Leads: 3 • Length: ~11 ft.	6-Pin; 1K Ω Resistors Jumper E to C 	Fixed Snap 	
RPI Part #KCB008 PATIENT CABLE - 3 LEAD FIXED SNAP • Number of Leads: 3 • Length: ~11 ft.	6-Pin Jumper E to B 	Fixed Snap 	
RPI Part #KCB036 OEM Part #11110-000029/3006218-02 PATIENT CABLE - 3 LEAD FIXED SNAP • Number of Leads: 3 • Length: ~10 ft.	12-Pin Right Angle 	Fixed Snap 	
RPI Part #KEB012 PATIENT CABLE - 5 LEAD FIXED SNAP • Number of Leads: 5 • Length: ~13 ft.	6-Pin 	Fixed Snap 	
RPI Part #KEB014 Old RPI Part #BUC009 PATIENT CABLE - 5 LEAD FIXED PIN • Number of Leads: 5 • Length: ~8 ft.	5-Pin 	Fixed .125" Pin 	<ul style="list-style-type: none"> • This cable replaces RPI Part #BUC009 • Also available: Leadwire Adapter Kit (RPI Part #LAK001)
RPI Part #KEB030 Old RPI Part #HPC005 PATIENT CABLE - 5 LEAD FIXED BANANA • Number of Leads: 5 • Length: ~13 ft.	6-Pin 	Fixed Banana Plug 	<ul style="list-style-type: none"> • This cable replaces RPI Part #HPC005 • Also available: Leadwire Adapter Kit (RPI Part #LAK001)
RPI Part #KKB002 PATIENT CABLE - 10 LEAD FIXED BANANA • Number of Leads: 10 • Length: ~10 ft.	15-Pin D-Sub 	Fixed Banana Plug 	<ul style="list-style-type: none"> • Also available: Leadwire Adapter Kit (RPI Part #LAK001)

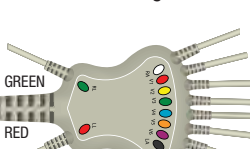
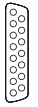
(continued on next page)

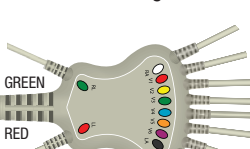
General Biomedical Equipment

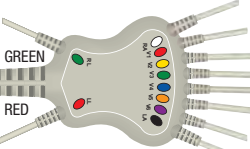
ECG, Monitoring & Defibrillators

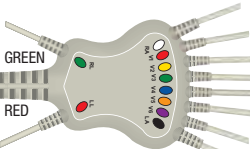
FIXED PATIENT CABLES *(Continued)*

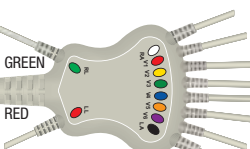

DESCRIPTION	EQUIPMENT END	PATIENT END	NOTES
RPI Part #KKB003 PATIENT CABLE - 10 LEAD FIXED BANANA • Number of Leads: 10 • Length: ~10 ft.	15-Pin D-Sub 	Fixed Banana Plug  	• Also available: Leadwire Adapter Kit (RPI Part #LAK001)
RPI Part #KKB006 PATIENT CABLE - 10 LEAD FIXED BANANA • Number of Leads: 10 • Length: ~10 ft.	15-Pin D-Sub; 20K Ω Resistors 	Fixed Banana Plug  	• Also available: Leadwire Adapter Kit (RPI Part #LAK001)
RPI Part #KKB007 PATIENT CABLE - 10 LEAD FIXED BANANA • Number of Leads: 10 • Length: ~10 ft.	15-Pin D-Sub; 10K Ω Resistors 	Fixed Banana Plug  	• Also available: Leadwire Adapter Kit (RPI Part #LAK001)
RPI Part #KKB008 PATIENT CABLE - 10 LEAD FIXED BANANA • Number of Leads: 10 • Length: ~10 ft.	15-Pin D-Sub; 10K Ω Resistors 	Fixed Banana Plug  	• Also available: Leadwire Adapter Kit (RPI Part #LAK001)
RPI Part #KKB010 OEM Part #60-00180-01/ 60-00184-01 PATIENT CABLE - 10 LEAD FIXED PINCH • Number of Leads: 10 • Length: ~18 ft.	12-Pin; 10K Ω Resistors 	Fixed Pinch  	
RPI Part #KKB011 OEM Part #60-00181-01/ 60-00185-01 PATIENT CABLE - 10 LEAD FIXED SNAP • Number of Leads: 10 • Length: ~18 ft.	12-Pin; 10K Ω Resistors 	Fixed Snap  	
RPI Part #KKB012 OEM Part #223 418 09 PATIENT CABLE - 10 LEAD FIXED BANANA • Number of Leads: 10 • Length: ~9 ft.	15-Pin D-Sub; 10K Ω Resistors 	Fixed Banana Plug  	• Also available: Leadwire Adapter Kit (RPI Part #LAK001)

NEW PART









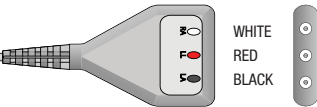

NEW PART

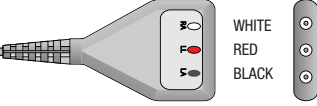
NEW PART

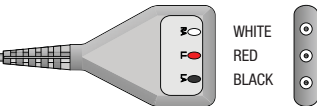
FIXED PATIENT CABLES ACCESSORIES (FOR BANANA & PIN STYLES)

DESCRIPTION	ACCESSORY	DETAILS
RPI Part #LAK001 LEADWIRE ADAPTER KIT	  Includes 10 adapters individually labeled with leadwire identifiers	<ul style="list-style-type: none"> • Includes 10 adapters individually labeled with leadwire identifiers • Adapts banana plugs or pins to tab or snap electrodes • Widest contact area for superior trace quality • Flat, wide bodied design helps prevent twisting • Durable construction - built to last

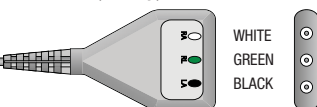
DIN/UNSHIELDED PATIENT CABLES

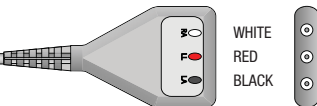









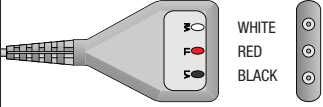

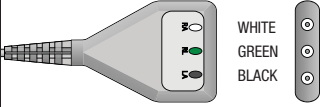
DESCRIPTION	EQUIPMENT END	PATIENT END	NOTES
RPI Part #KCA001 PATIENT CABLE - 3 LEAD DIN <ul style="list-style-type: none"> • Number of Leads: 3 • Length: ~10 ft. 	6-Pin; 1K Ω Resistors Jumper E to C 	Din/Unshielded .060" Pin (Safety) 	Reusable Leadwire Sets RPI Part #'s LKM002 & LKM005 Disposable Leadwire Sets RPI Part #'s LDM301 & LDM308 Veterinary Leadwire Set RPI Part #LVM701
RPI Part #KCA004 PATIENT CABLE - 3 LEAD DIN <ul style="list-style-type: none"> • Number of Leads: 3 • Length: ~10 ft. 	6-Pin; 1K Ω Resistors 	Din/Unshielded .060" Pin (Safety) 	Reusable Leadwire Sets RPI Part #'s LKM002 & LKM005 Disposable Leadwire Sets RPI Part #'s LDM301 & LDM308 Veterinary Leadwire Set RPI Part #LVM701
RPI Part #KCA007 PATIENT CABLE - 3 LEAD DIN <ul style="list-style-type: none"> • Number of Leads: 3 • Length: ~10 ft. 	6-Pin Jumper E to B 	Din/Unshielded .060" Pin (Safety) 	Reusable Leadwire Sets RPI Part #'s LKM002 & LKM005 Disposable Leadwire Sets RPI Part #'s LDM301 & LDM308 Veterinary Leadwire Set RPI Part #LVM701
RPI Part #KCA010 PATIENT CABLE - 3 LEAD DIN <ul style="list-style-type: none"> • Number of Leads: 3 • Length: ~10 ft. 	12-Pin; 1K Ω Resistors 	Din/Unshielded .060" Pin (Safety) 	Reusable Leadwire Sets RPI Part #'s LKM002 & LKM005 Disposable Leadwire Sets RPI Part #'s LDM301 & LDM308 Veterinary Leadwire Set RPI Part #LVM701
RPI Part #KCA013 PATIENT CABLE - 3 LEAD DIN <ul style="list-style-type: none"> • Number of Leads: 3 • Length: ~10 ft. 	5-Pin 	Din/Unshielded .060" Pin (Safety) 	Reusable Leadwire Sets RPI Part #'s LKM008 & LKM011 Disposable Leadwire Sets RPI Part #'s LDM302 & LDM309 Veterinary Leadwire Set RPI Part #LVM702
RPI Part #KCA016 PATIENT CABLE - 3 LEAD DIN <ul style="list-style-type: none"> • Number of Leads: 3 • Length: ~10 ft. 	6-Pin 	Din/Unshielded .060" Pin (Safety) 	Reusable Leadwire Sets RPI Part #'s LKM002 & LKM005 Disposable Leadwire Sets RPI Part #'s LDM301 & LDM308 Veterinary Leadwire Set RPI Part #LVM701

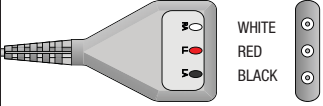
(continued on next page)

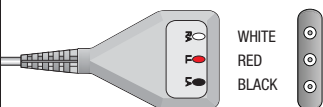
General Biomedical Equipment

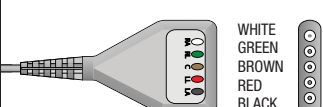



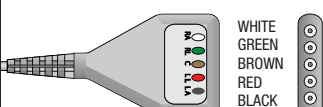







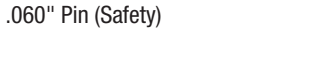

ECG, Monitoring & Defibrillators

DIN/UNSHIELDED PATIENT CABLES (Continued)

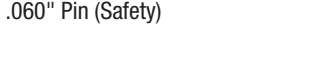
DESCRIPTION	EQUIPMENT END	PATIENT END	NOTES
RPI Part #KCA019 PATIENT CABLE - 3 LEAD DIN • Number of Leads: 3 • Length: ~10 ft.	11-Pin; Jumper 5 to 6 with 120M Ω Resistor 	Din/Unshielded .060" Pin (Safety) 	Reusable Leadwire Sets RPI Part #'s LKM002 & LKM005 Disposable Leadwire Sets RPI Part #'s LDM301 & LDM308 Veterinary Leadwire Set RPI Part #LVM701
RPI Part #KCA022 Old RPI Part #HPC004 PATIENT CABLE - 3 LEAD DIN • Number of Leads: 3 • Length: ~10 ft.	8-Pin; 1K Ω Resistors 	Din/Unshielded .060" Pin (Safety) 	Reusable Leadwire Sets RPI Part #'s LKM008 & LKM011 Disposable Leadwire Sets RPI Part #'s LDM302 & LDM309 Veterinary Leadwire Set RPI Part #LVM702
RPI Part #KCA025 PATIENT CABLE - 3 LEAD DIN • Number of Leads: 3 • Length: ~10 ft.	8-Pin; 1K Ω Resistors 	Din/Unshielded .060" Pin (Safety) 	Reusable Leadwire Sets RPI Part #'s LKM002 & LKM005 Disposable Leadwire Sets RPI Part #'s LDM301 & LDM308 Veterinary Leadwire Set RPI Part #LVM701
RPI Part #KCA035 OEM Part #11110-000029/ 3006218-02 PATIENT CABLE - 3 LEAD DIN • Number of Leads: 3 • Length: ~10 ft.	12-Pin Right Angle; 10K Ω Resistors 	Din/Unshielded .060" Pin (Safety) 	Reusable Leadwire Sets RPI Part #'s LKM002 & LKM005 Disposable Leadwire Sets RPI Part #'s LDM301 & LDM308 Veterinary Leadwire Set RPI Part #LVM701
RPI Part #KEA001 PATIENT CABLE - 5 LEAD DIN • Number of Leads: 5 • Length: ~10 ft.	11-Pin 	Din/Unshielded .060" Pin (Safety) 	Reusable Leadwire Sets RPI Part #'s LKM026, LKM029 & LKM030 Disposable Leadwire Sets RPI Part #'s LDM303 & LDM310 Veterinary Leadwire Set RPI Part #LVM703
RPI Part #KEA005 PATIENT CABLE - 5 LEAD DIN • Number of Leads: 5 • Length: ~10 ft.	12-Pin; 1K Ω Resistors 	Din/Unshielded .060" Pin (Safety) 	Reusable Leadwire Sets RPI Part #'s LKM026, LKM029 & LKM030 Disposable Leadwire Sets RPI Part #'s LDM303 & LDM310 Veterinary Leadwire Set RPI Part #LVM703
RPI Part #KEA017 Old RPI Part #HPC006 PATIENT CABLE - 5 LEAD DIN • Number of Leads: 5 • Length: ~10 ft.	8-Pin; 1K Ω Resistors 	Din/Unshielded .060" Pin (Safety) 	Reusable Leadwire Sets RPI Part #'s LKM026, LKM029 & LKM030 Disposable Leadwire Sets RPI Part #'s LDM303 & LDM310 Veterinary Leadwire Set RPI Part #LVM703

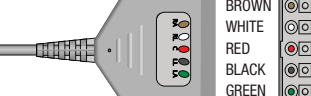

DUAL/SHIELDED PATIENT CABLES



DESCRIPTION	EQUIPMENT END	PATIENT END	NOTES
RPI Part #KCC003 PATIENT CABLE - 3 LEAD DUAL • Number of Leads: 3 • Length: ~10 ft.	6-Pin; 1K Ω Resistors Jumper E to C 	Dual/Shielded .060" Pin (Safety) 	Reusable Leadwire Sets RPI Part #'s LKM014 & LKM017 Disposable Leadwire Sets RPI Part #'s LDM305 & LDM312 Veterinary Leadwire Set RPI Part #LVM705
RPI Part #KCC009 PATIENT CABLE - 3 LEAD DUAL • Number of Leads: 3 • Length: ~10 ft.	6-Pin; Jumper E to B 	Dual/Shielded .060" Pin (Safety) 	Reusable Leadwire Sets RPI Part #'s LKM014 & LKM017 Disposable Leadwire Sets RPI Part #'s LDM305 & LDM312 Veterinary Leadwire Set RPI Part #LVM705
RPI Part #KCC012 PATIENT CABLE - 3 LEAD DUAL • Number of Leads: 3 • Length: ~10 ft.	12-Pin; 1K Ω Resistors 	Dual/Shielded .060" Pin (Safety) 	Reusable Leadwire Sets RPI Part #'s LKM014 & LKM017 Disposable Leadwire Sets RPI Part #'s LDM305 & LDM312 Veterinary Leadwire Set RPI Part #LVM705
RPI Part #KCC021 PATIENT CABLE - 3 LEAD DUAL • Number of Leads: 3 • Length: ~10 ft.	11-Pin; Jumper 5 to 6 with 120M Ω Resistor 	Dual/Shielded .060" Pin (Safety) 	Reusable Leadwire Sets RPI Part #'s LKM014 & LKM017 Disposable Leadwire Sets RPI Part #'s LDM305 & LDM312 Veterinary Leadwire Set RPI Part #LVM705
RPI Part #KCC034 OEM Part #545302 PATIENT CABLE - 3 LEAD DUAL • Number of Leads: 3 • Length: ~10 ft.	10-Socket; 4.7K Ω Resistors 	Dual/Shielded .060" Pin (Safety) 	Reusable Leadwire Sets RPI Part #'s LKM014 & LKM017 Disposable Leadwire Sets RPI Part #'s LDM305 & LDM312 Veterinary Leadwire Set RPI Part #LVM705
RPI Part #KEC003 PATIENT CABLE - 5 LEAD DUAL • Number of Leads: 5 • Length: ~10 ft.	11-Pin 	Dual/Shielded .060" Pin (Safety) 	Reusable Leadwire Sets RPI Part #'s LKM032 & LKM035 Disposable Leadwire Sets RPI Part #'s LDM307 & LDM314 Veterinary Leadwire Set RPI Part #LVM707
RPI Part #KEC007 PATIENT CABLE - 5 LEAD DUAL • Number of Leads: 5 • Length: ~10 ft.	12-Pin; 1K Ω Resistors 	Dual/Shielded .060" Pin (Safety) 	Reusable Leadwire Sets RPI Part #'s LKM032 & LKM035 Disposable Leadwire Sets RPI Part #'s LDM307 & LDM314 Veterinary Leadwire Set RPI Part #LVM707
RPI Part #KEC010 PATIENT CABLE - 5 LEAD DUAL • Number of Leads: 5 • Length: ~10 ft.	6-Pin; 1K Ω Resistors 	Dual/Shielded .060" Pin (Safety) 	Reusable Leadwire Sets RPI Part #'s LKM032 & LKM035 Disposable Leadwire Sets RPI Part #'s LDM307 & LDM314 Veterinary Leadwire Set RPI Part #LVM707

(continued on next page)

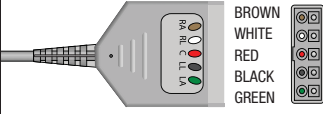

General Biomedical Equipment

ECG, Monitoring & Defibrillators

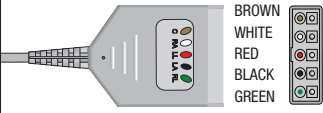
DUAL/SHIELDED PATIENT CABLES (Continued)

DESCRIPTION	EQUIPMENT END	PATIENT END	NOTES
RPI Part #KEC016 PATIENT CABLE - 5 LEAD DUAL • Number of Leads: 5 • Length: ~10 ft.	17-Pin; 1K Ω Resistors Jumper 1 to 3 with 16K Ω Resistor 	Dual/Shielded .060" Pin (Safety) 	Reusable Leadwire Sets RPI Part #'s LKM032 & LKM035 Disposable Leadwire Sets RPI Part #'s LDM307 & LDM314 Veterinary Leadwire Set RPI Part #LVM707
RPI Part #KEC022 OEM Part #545303 PATIENT CABLE - 5 LEAD DUAL • Number of Leads: 5 • Length: ~10 ft.	10-Socket; 4.7K Ω Resistors 	Dual/Shielded .060" Pin (Safety) 	Reusable Leadwire Sets RPI Part #'s LKM032 & LKM035 Disposable Leadwire Sets RPI Part #'s LDM307 & LDM314 Veterinary Leadwire Set RPI Part #LVM707



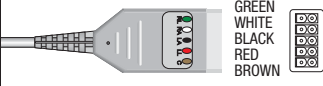

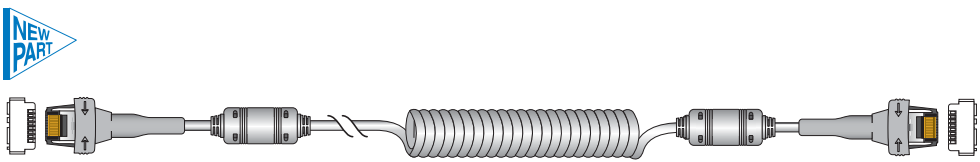
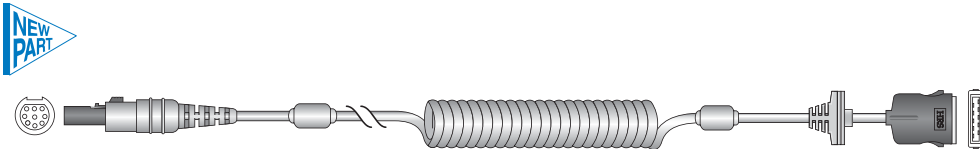

DUAL/SHIELDED PATIENT CABLES TO FIT GE MULTI-LINK®

DESCRIPTION	EQUIPMENT END	PATIENT END	NOTES
RPI Part #KCD033 OEM Part #1554AA0 PATIENT CABLE - 3 LEAD MULTI-LINK • Number of Leads: 3 • Length: ~10 ft.	12-Pin 	Dual/Shielded; Compatible with GE Multi-Link® 	Reusable Leadwire Sets RPI Part #'s LKM052 & LKM053
RPI Part #KED021 OEM Part #2017003-001/412931-001 PATIENT CABLE - 5 LEAD MULTI-LINK • Number of Leads: 5 • Length: ~10 ft.	11-Pin 	Dual/Shielded; Compatible with GE Multi-Link® 	Reusable Leadwire Sets RPI Part #'s LKM052, LKM053, LKM054, LKM055, LKM056 & LKM057

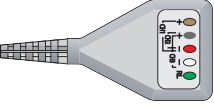

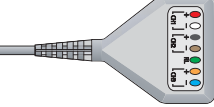

CABLES TO FIT GE ACQUISITION MODULES

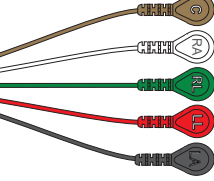
DESCRIPTION	
RPI Part #GEC020 OEM Part #700044-201/700044-202/700044-204 ACQUISITION MODULE CABLE • Length: ~17 ft. overall length Fits: AM4 Acquisition Module and AM5 Acquisition Module	
RPI Part #GEC021 OEM Part #2016560-002/2016560-003/700657-002/700657-003 ACQUISITION MODULE CABLE • Length: ~17 ft. overall length Fits: CAM 14 Acquisition Module	

HOLTER CABLES

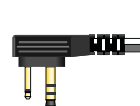
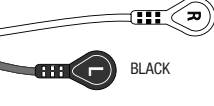
DESCRIPTION	EQUIPMENT END	PATIENT END	NOTES
RPI Part #KEA004 HOLTER CABLE - 5 LEAD 3 CHANNEL • Number of Leads: 5 • Length: ~30"	7-Socket; Jumper 1 to 5 and 2 to 6 	Din/Unshielded .060" Pin (Safety)  <ul style="list-style-type: none"> BROWN BLACK RED WHITE GREEN 	Reusable Leadwire Sets RPI Part #'s LKM026, LKM029 & LKM030 Disposable Leadwire Sets RPI Part #'s LDM303 & LDM310 Veterinary Leadwire Set RPI Part #LVM703
RPI Part #KGA001 HOLTER CABLE - 7 LEAD 3 CHANNEL • Number of Leads: 7 • Length: ~40"	7-Socket 	Din/Unshielded .060" Pin (Safety)  <ul style="list-style-type: none"> RED WHITE BLACK BROWN GREEN ORANGE BLUE 	Reusable Leadwire Sets RPI Part #'s LKM038 & LKM041 Disposable Leadwire Sets RPI Part #'s LDM304 & LDM311 Veterinary Leadwire Set RPI Part #LVM704
RPI Part #KEB020 OEM Part #3-370-0001 HOLTER CABLE - 5 LEAD FIXED SNAP • Number of Leads: 5 • Length: ~43" 	7-Socket 	Fixed Snap  <ul style="list-style-type: none"> BROWN WHITE GREEN RED BLACK 	

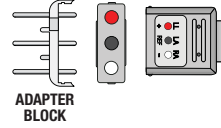
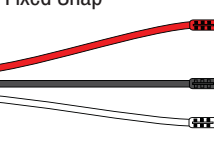
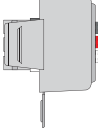
TELEMETRY CABLES





DESCRIPTION	EQUIPMENT END	PATIENT END	NOTES
RPI Part #KBB001 TELEMETRY CABLE - 2 LEAD SNAP • Number of Leads: 2 • Length: ~32"	Dual Phono Plug 90-Deg 	Fixed Snap  <ul style="list-style-type: none"> WHITE BLACK 	
RPI Part #KCB028 TELEMETRY CABLE - 3 LEAD SNAP • Number of Leads: 3 • Length: ~27"	7-Socket; Jumper 1 to 5 	Fixed Snap  <ul style="list-style-type: none"> RED WHITE BLACK 	• Also available: 3 Lead Organizer (RPI Part #LAR004)
RPI Part #KCB029 Old RPI Part #HPC008 TELEMETRY CABLE - 3 LEAD SNAP • Number of Leads: 3 • Length: ~30"	3-Lead Safety Block 	Fixed Snap  <ul style="list-style-type: none"> RED BLACK WHITE 	• This cable replaces RPI Part #HPC008 • Includes Adapter Block • Also available: 3 Lead Organizer (RPI Part #LAR004)
RPI Part #KCB031 TELEMETRY CABLE - 3 LEAD SNAP • Number of Leads: 3 • Length: ~30"	Dual/Shielded 	Fixed Snap  <ul style="list-style-type: none"> BLACK RED WHITE 	• Includes: 3 Lead Organizer (RPI Part #LAR004)

(continued on next page)

General Biomedical Equipment

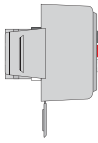
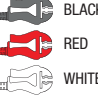
ECG, Monitoring & Defibrillators

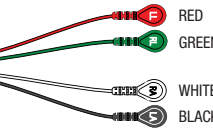
TELEMETRY CABLES *(Continued)*

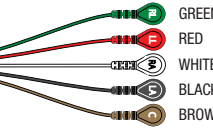
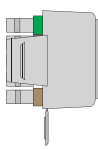
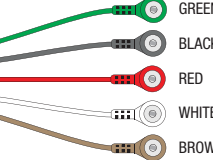
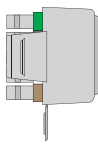
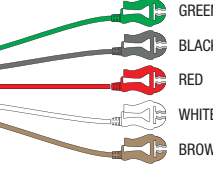
DESCRIPTION	EQUIPMENT END	PATIENT END	NOTES
RPI Part #KCB032 TELEMETRY CABLE - 3 LEAD PINCH • Number of Leads: 3 • Length: ~30"	Dual/Shielded 	Fixed Pinch 	<ul style="list-style-type: none"> Includes: 3 Lead Organizer (RPI Part #LAR004)
RPI Part #KDB002 TELEMETRY CABLE - 4 LEAD SNAP • Number of Leads: 4 • Length: ~27"	7-Socket 	Fixed Snap 	<ul style="list-style-type: none"> Also available: 5 Lead Organizer (RPI Part #LAR005)
RPI Part #KEB015 TELEMETRY CABLE - 5 LEAD SNAP • Number of Leads: 5 • Length: ~24"	7-Socket 	Fixed Snap 	<ul style="list-style-type: none"> Also available: 5 Lead Organizer (RPI Part #LAR005)
RPI Part #KEB018 TELEMETRY CABLE - 5 LEAD SNAP • Number of Leads: 5 • Length: ~30"	Dual/Shielded 	Fixed Snap 	<ul style="list-style-type: none"> Includes: 5 Lead Organizer (RPI Part #LAR005)
RPI Part #KEB019 TELEMETRY CABLE - 5 LEAD PINCH • Number of Leads: 5 • Length: ~30"	Dual/Shielded 	Fixed Pinch 	<ul style="list-style-type: none"> Includes: 5 Lead Organizer (RPI Part #LAR005)

NOTES: _____

REUSABLE: BONDED LEADWIRE SETS TO FIT GE MULTI-LINK®

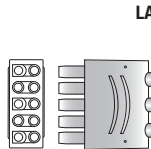
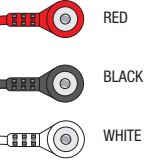
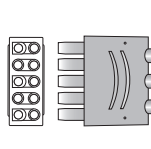
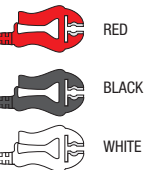
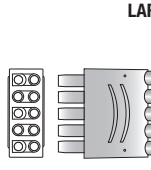
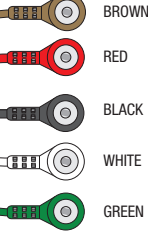
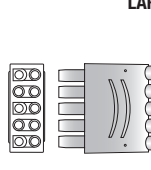
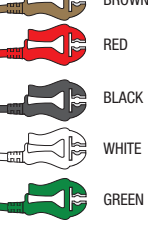
DESCRIPTION	EQUIPMENT END	PATIENT END
<p>RPI Part #LKM052 OEM Part #411203-001</p> <p>3 LEADWIRE SET - 30" MULTI-LINK/SNAP</p> <ul style="list-style-type: none"> • Number of Leads: 3 Bonded leadwires • Length: ~30" • Includes: 3 Lead Organizer (RPI Part #LAR004) <p>Also available:</p> <ul style="list-style-type: none"> • Bonded Leadwire Sets (RPI Part #'s LKM053, LKM054 & LKM055) & Combined Leadwire Sets (RPI Part #'s LKM056 & LKM057) <p>Fits: GE Multi-Link® Cable, Patient Cable - 5 Lead Multi-Link® (RPI Part #KED021) and Patient Cable - 3 Lead Multi-Link® (RPI Part #KCD033)</p>	<p>Dual/Shielded; Jumper 1 to 5 with 130M Ω Resistor; Compatible with GE Multi-Link®</p> 	<p>Snap</p> 
<p>RPI Part #LKM053 OEM Part #412682-001</p> <p>3 LEADWIRE SET - 30" MULTI-LINK/PINCH</p> <ul style="list-style-type: none"> • Number of Leads: 3 Bonded leadwires • Length: ~30" • Includes: 3 Lead Organizer (RPI Part #LAR004) <p>Also available:</p> <ul style="list-style-type: none"> • Bonded Leadwire Sets (RPI Part #'s LKM052, LKM054 & LKM055) & Combined Leadwire Sets (RPI Part #'s LKM056 & LKM057) <p>Fits: GE Multi-Link® Cable, Patient Cable - 5 Lead Multi-Link® (RPI Part #KED021) and Patient Cable - 3 Lead Multi-Link® (RPI Part #KCD033)</p>	<p>Dual/Shielded; Jumper 1 to 5 with 130M Ω Resistor; Compatible with GE Multi-Link®</p> 	<p>Pinch</p> 
<p>RPI Part #LKM054 OEM Part #411202-001</p> <p>5 LEADWIRE SET - 30" MULTI-LINK/SNAP</p> <ul style="list-style-type: none"> • Number of Leads: 5 Bonded leadwires • Length: ~30" • Includes: 5 Lead Organizer (RPI Part #LAR005) <p>Also available:</p> <ul style="list-style-type: none"> • Bonded Leadwire Sets (RPI Part #'s LKM052, LKM053 & LKM055) & Combined Leadwire Sets (RPI Part #'s LKM056 & LKM057) <p>Fits: GE Multi-Link® Cable and Patient Cable - 5 Lead Multi-Link® (RPI Part #KED021)</p>	<p>Dual/Shielded; Compatible with GE Multi-Link®</p> 	<p>Snap</p> 
<p>RPI Part #LKM055 OEM Part #412681-001</p> <p>5 LEADWIRE SET - 30" MULTI-LINK/PINCH</p> <ul style="list-style-type: none"> • Number of Leads: 5 Bonded leadwires • Length: ~30" • Includes: 5 Lead Organizer (RPI Part #LAR005) <p>Also available:</p> <ul style="list-style-type: none"> • Bonded Leadwire Sets (RPI Part #'s LKM052, LKM053 & LKM054) & Combined Leadwire Sets (RPI Part #'s LKM056 & LKM057) <p>Fits: GE Multi-Link® Cable and Patient Cable - 5 Lead Multi-Link® (RPI Part #KED021)</p>	<p>Dual/Shielded; Compatible with GE Multi-Link®</p> 	<p>Pinch</p> 

General Biomedical Equipment

ECG, Monitoring & Defibrillators

REUSABLE: COMBINED LEADWIRE SETS TO FIT GE MULTI-LINK®

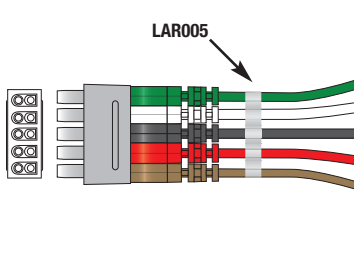
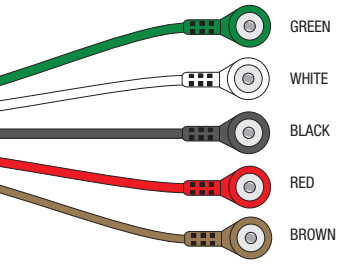
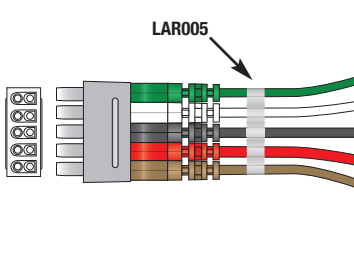
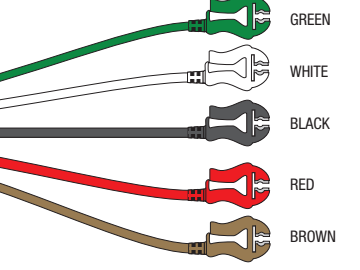
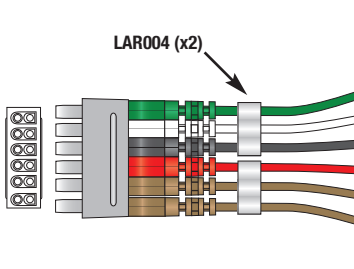
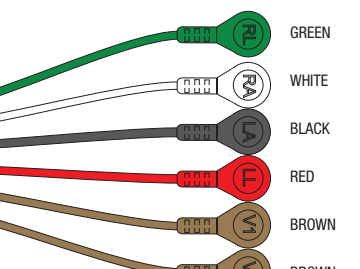
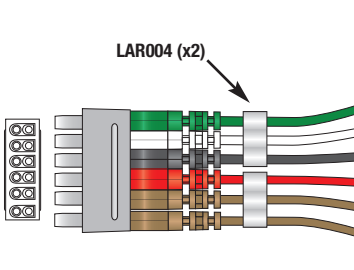
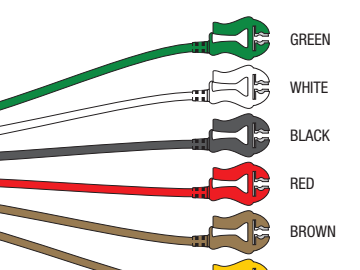
DESCRIPTION	EQUIPMENT END	PATIENT END
<p>RPI Part #LKM056 OEM Part #411200-001</p> <p>5 LEADWIRE SET - 30" MULTI-LINK/SNAP</p> <ul style="list-style-type: none"> Number of Leads: 5 individual leadwires with combiner Length: ~30" Includes: 5 Lead Organizer (RPI Part #LAR005) and combiner <p>Also available:</p> <ul style="list-style-type: none"> Bonded Leadwire Sets (RPI Part #'s LKM052, LKM053, LKM054 & LKM055) & Combined Leadwire Set (RPI Part #LKM057) <p>Fits: GE Multi-Link® Cable and Patient Cable - 5 Lead Multi-Link® (RPI Part #KED021)</p>	<p>Dual/Shielded; Compatible with GE Multi-Link®</p> 	<p>Snap</p> 
<p>RPI Part #LKM057 OEM Part #414556-001</p> <p>5 LEADWIRE SET - 30" MULTI-LINK/PINCH</p> <ul style="list-style-type: none"> Number of Leads: 5 individual leadwires with combiner Length: ~30" Includes: 5 Lead Organizer (RPI Part #LAR005) and combiner <p>Also available:</p> <ul style="list-style-type: none"> Bonded Leadwire Sets (RPI Part #'s LKM052, LKM053, LKM054 & LKM055) & Combined Leadwire Set (RPI Part #LKM056) <p>Fits: GE Multi-Link® Cable and Patient Cable - 5 Lead Multi-Link® (RPI Part #KED021)</p>	<p>Dual/Shielded; Compatible with GE Multi-Link®</p> 	<p>Pinch</p> 
<p>RPI Part #LKM058 OEM Part #421930-001</p> <p>6 LEADWIRE SET - 30" MULTI-LINK/SNAP</p> <ul style="list-style-type: none"> Number of Leads: 6 individual leadwires with combiner Length: ~30" Includes: (2) 3 Lead Organizer (RPI Part #LAR004) and 6 lead combiner <p>Also available:</p> <ul style="list-style-type: none"> Combined Leadwire Set (RPI Part #LKM059) 	<p>Dual/Shielded; Compatible with GE Multi-Link®</p> 	<p>Snap</p> 
<p>RPI Part #LKM059 OEM Part #421932-001</p> <p>6 LEADWIRE SET - 30" MULTI-LINK/PINCH</p> <ul style="list-style-type: none"> Number of Leads: 6 individual leadwires with combiner Length: ~30" Includes: (2) 3 Lead Organizer (RPI Part #LAR004) and 6 lead combiner <p>Also available:</p> <ul style="list-style-type: none"> Combined Leadwire Set (RPI Part #LKM058) 	<p>Dual/Shielded; Compatible with GE Multi-Link®</p> 	<p>Pinch</p> 



REUSABLE: LEADWIRE SETS TO FIT GE MULTI-LINK®







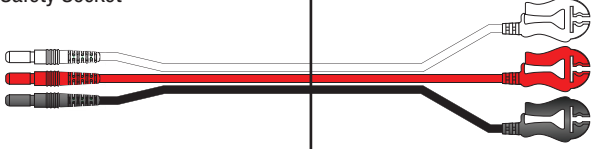

DESCRIPTION	EQUIPMENT END	PATIENT END
<p>RPI Part #LKM049 OEM Part #420101-002</p> <p>10 LEADWIRE SET - CAM 14/BANANA</p> <ul style="list-style-type: none"> • Number of Leads: 10 • Length: ~27": Red (V1), Yellow (V2), Green (V3), Blue (V4), Orange (V5), Violet (V6); and, ~37": Green (RL), White (RA), Black (LA) & Red (LL) • Includes: (2) 5 Lead Organizer (RPI Part #LAR005) <p>Also available:</p> <ul style="list-style-type: none"> • 10 Leadwire Set - CAM 14/Pinch (RPI Part #LKM050) & • 10 Leadwire Set - CAM 14/Snap (RPI Part #LKM051) <p>Fits: CAM 14 Module</p>	<p>Dual/Shielded; Compatible with GE Multi-Link®</p>	<p>Banana Plug</p>
<p>RPI Part #LKM050 OEM Part #420101-002</p> <p>10 LEADWIRE SET - CAM 14/PINCH</p> <ul style="list-style-type: none"> • Number of Leads: 10 • Length: ~27": Red (V1), Yellow (V2), Green (V3), Blue (V4), Orange (V5), Violet (V6); and, ~37": Green (RL), White (RA), Black (LA) & Red (LL) • Includes: (2) 5 Lead Organizer (RPI Part #LAR005) <p>Also available:</p> <ul style="list-style-type: none"> • 10 Leadwire Set - CAM 14/Banana (RPI Part #LKM049) & • 10 Leadwire Set - CAM 14/Snap (RPI Part #LKM051) <p>Fits: CAM 14 Module</p>	<p>Dual/Shielded; Compatible with GE Multi-Link®</p>	<p>Pinch</p>
<p>RPI Part #LKM051 OEM Part #420101-002</p> <p>10 LEADWIRE SET - CAM 14/SNAP</p> <ul style="list-style-type: none"> • Number of Leads: 10 • Length: ~27": Red (V1), Yellow (V2), Green (V3), Blue (V4), Orange (V5), Violet (V6); and, ~37": Green (RL), White (RA), Black (LA) & Red (LL) • Includes: (2) 5 Lead Organizer (RPI Part #LAR005) <p>Also available:</p> <ul style="list-style-type: none"> • 10 Leadwire Set - CAM 14/Banana (RPI Part #LKM049) & • 10 Leadwire Set - CAM 14/Pinch (RPI Part #LKM050) <p>Fits: CAM 14 Module</p>	<p>Dual/Shielded; Compatible with GE Multi-Link®</p>	<p>Snap</p>

General Biomedical Equipment

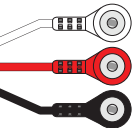
ECG, Monitoring & Defibrillators

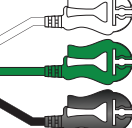
REUSABLE: DIN/UNSHIELDED LEADWIRE SETS

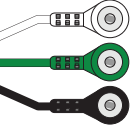
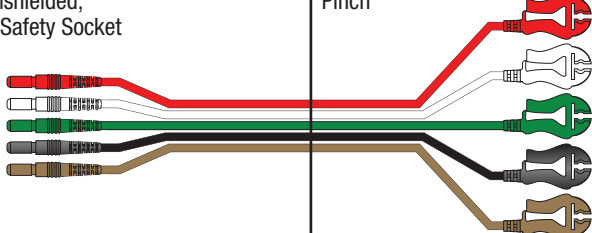
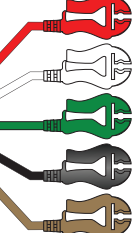
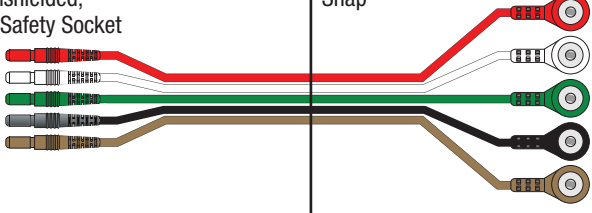
Accessories Also Available

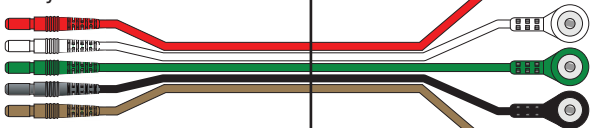
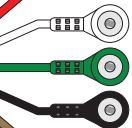
DESCRIPTION	EQUIPMENT END	PATIENT END
<p>RPI Part #LKM002 3 LEADWIRE SET - 24" DIN/PINCH • Number of Leads: 3 • Length: 24" Also available: • Disposable Leadwire Set (RPI Part #LDM308) & 3 Lead Organizer (RPI Part #LAR004)</p>	<p>Din/Unshielded; .060" Safety Socket</p> 	<p>Pinch</p>  <p>WHITE RED BLACK</p>
<p>RPI Part #LKM005 3 LEADWIRE SET - 24" DIN/SNAP • Number of Leads: 3 • Length: 24" Also available: • Disposable Leadwire Set (RPI Part #LDM301) & 3 Lead Organizer (RPI Part #LAR004)</p>	<p>Din/Unshielded; .060" Safety Socket</p> 	<p>Snap</p>  <p>WHITE RED BLACK</p>
<p>RPI Part #LKM008 3 LEADWIRE SET - 24" DIN/PINCH • Number of Leads: 3 • Length: 24" Also available: • Disposable Leadwire Set (RPI Part #LDM309) & 3 Lead Organizer (RPI Part #LAR004)</p>	<p>Din/Unshielded; .060" Safety Socket</p> 	<p>Pinch</p>  <p>WHITE GREEN BLACK</p>
<p>RPI Part #LKM011 Old RPI Part #HPC003 3 LEADWIRE SET - 24" DIN/SNAP • Number of Leads: 3 • Length: 24" Also available: • Disposable Leadwire Set (RPI Part #LDM302) & 3 Lead Organizer (RPI Part #LAR004)</p>	<p>Din/Unshielded; .060" Safety Socket</p> 	<p>Snap</p>  <p>WHITE GREEN BLACK</p>
<p>RPI Part #LKM026 5 LEADWIRE SET - 24" DIN/PINCH • Number of Leads: 5 • Length: 24" Also available: • Disposable Leadwire Set (RPI Part #LDM310) & 5 Lead Organizer (RPI Part #LAR005)</p>	<p>Din/Unshielded; .060" Safety Socket</p> 	<p>Pinch</p>  <p>RED WHITE GREEN BLACK BROWN</p>
<p>RPI Part #LKM029 5 LEADWIRE SET - 24" DIN/SNAP • Number of Leads: 5 • Length: 24" Also available: • 24" Disposable Leadwire Set (RPI Part #LDM303) & 5 Lead Organizer (RPI Part #LAR005)</p>	<p>Din/Unshielded; .060" Safety Socket</p> 	<p>Snap</p>  <p>RED WHITE GREEN BLACK BROWN</p>
<p>RPI Part #LKM030 Old RPI Part #HPC007 5 LEADWIRE SET - 40" DIN/SNAP • Number of Leads: 5 • Length: 40" Also available: • 24" Disposable Leadwire Set (RPI Part #LDM303) & 5 Lead Organizer (RPI Part #LAR005)</p>	<p>Din/Unshielded; .060" Safety Socket</p> 	<p>Snap</p>  <p>RED WHITE GREEN BLACK BROWN</p>

(continued on next page)

Accessories Also Available

REUSABLE: DIN/UNSHIELDED LEADWIRE SETS (Continued)

DESCRIPTION	EQUIPMENT END	PATIENT END
RPI Part #LKM038 7 LEADWIRE SET - 24" DIN/PINCH • Number of Leads: 7 • Length: 24" Also available: • Disposable Leadwire Set (RPI Part #LDM311), 3 Lead Organizer (RPI Part #LAR004) & 5 Lead Organizer (RPI Part #LAR005)	Din/Unshielded; .060" Safety Socket	Pinch
RPI Part #LKM041 7 LEADWIRE SET - 24" DIN/SNAP • Number of Leads: 7 • Length: 24" Also available: • Disposable Leadwire Set (RPI Part #LDM304), 3 Lead Organizer (RPI Part #LAR004) & 5 Lead Organizer (RPI Part #LAR005)	Din/Unshielded; .060" Safety Socket	Snap

REUSABLE: DIN/UNSHIELDED INDIVIDUAL LEADWIRES

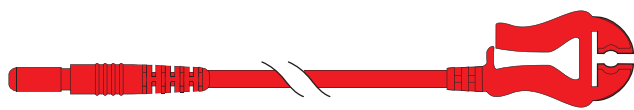

- Equipment End: Din/Unshielded, .060" Safety Socket
- Patient End: Pinch
- Length: 24"

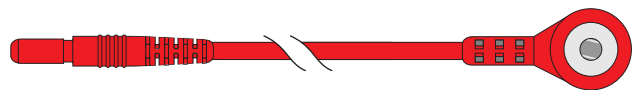

- Equipment End: Din/Unshielded, .060" Safety Socket
- Patient End: Snap
- Length: 24"







DESCRIPTION	LEADWIRE COLOR	DESCRIPTION	LEADWIRE COLOR
RPI Part #LPB002 LEADWIRE BLACK 24" DIN/PINCH	Black	RPI Part #LSB002 LEADWIRE BLACK 24" DIN/SNAP	Black
RPI Part #LPE002 LEADWIRE ORANGE 24" DIN/PINCH	Orange	RPI Part #LSE002 LEADWIRE ORANGE 24" DIN/SNAP	Orange
RPI Part #LPG002 LEADWIRE GREEN 24" DIN/PINCH	Green	RPI Part #LSG002 LEADWIRE GREEN 24" DIN/SNAP	Green
RPI Part #LPN002 LEADWIRE BROWN 24" DIN/PINCH	Brown	RPI Part #LSN002 LEADWIRE BROWN 24" DIN/SNAP	Brown
RPI Part #LPR002 LEADWIRE RED 24" DIN/PINCH	Red	RPI Part #LSR002 LEADWIRE RED 24" DIN/SNAP	Red
RPI Part #LPU002 LEADWIRE BLUE 24" DIN/PINCH	Blue	RPI Part #LSU002 LEADWIRE BLUE 24" DIN/SNAP	Blue
RPI Part #LPW002 LEADWIRE WHITE 24" DIN/PINCH	White	RPI Part #LSW002 LEADWIRE WHITE 24" DIN/SNAP	White

Depending on equipment model, these leadwires are also available as sets – see *REUSABLE: DIN/UNSHIELDED LEADWIRE SETS* on previous page.

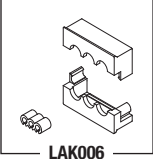
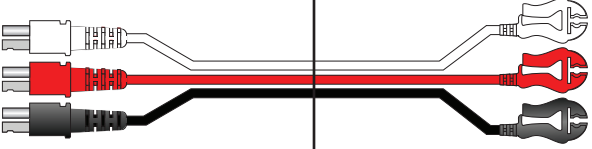
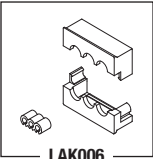
General Biomedical Equipment

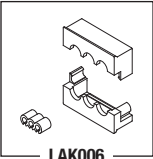
ECG, Monitoring & Defibrillators

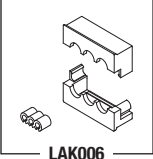
REUSABLE: DUAL/SHIELDED LEADWIRE SETS

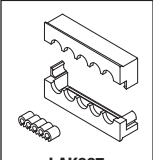
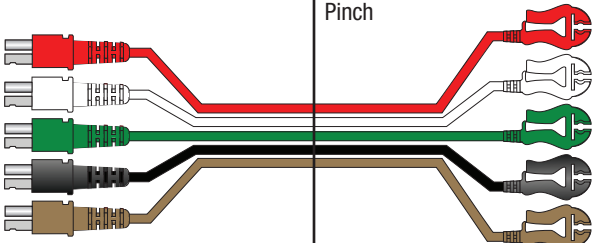
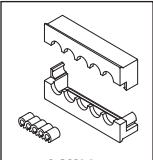
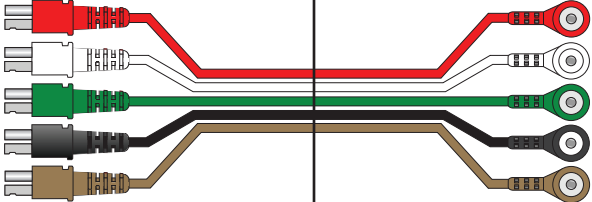



DESCRIPTION	EQUIPMENT END	PATIENT END
<p>RPI Part #LKM014</p> <p>3 LEADWIRE SET - 40" DUAL/PINCH</p> <ul style="list-style-type: none"> • Number of Leads: 3 • Length: 40" • Includes: 3 Lead Shielded Accessory Kit (RPI Part #LAK006) <p>Also available:</p> <ul style="list-style-type: none"> • Disposable Leadwire Set (RPI Part #LDM312) 	<p>Dual/Shielded</p>  <p>LAK006</p>	<p>Pinch</p>  <p>WHITE RED BLACK</p>
<p>RPI Part #LKM017</p> <p>3 LEADWIRE SET - 40" DUAL/SNAP</p> <ul style="list-style-type: none"> • Number of Leads: 3 • Length: 40" • Includes: 3 Lead Shielded Accessory Kit (RPI Part #LAK006) <p>Also available:</p> <ul style="list-style-type: none"> • Disposable Leadwire Set (RPI Part #LDM305) 	<p>Dual/Shielded</p>  <p>LAK006</p>	<p>Snap</p>  <p>WHITE RED BLACK</p>
<p>RPI Part #LKM020</p> <p>3 LEADWIRE SET - 40" DUAL/PINCH</p> <ul style="list-style-type: none"> • Number of Leads: 3 • Length: 40" • Includes: 3 Lead Shielded Accessory Kit (RPI Part #LAK006) <p>Also available:</p> <ul style="list-style-type: none"> • Disposable Leadwire Set (RPI Part #LDM313) 	<p>Dual/Shielded</p>  <p>LAK006</p>	<p>Pinch</p>  <p>WHITE GREEN BLACK</p>
<p>RPI Part #LKM023</p> <p>3 LEADWIRE SET - 40" DUAL/SNAP</p> <ul style="list-style-type: none"> • Number of Leads: 3 • Length: 40" • Includes: 3 Lead Shielded Accessory Kit (RPI Part #LAK006) <p>Also available:</p> <ul style="list-style-type: none"> • Disposable Leadwire Set (RPI Part #LDM306) 	<p>Dual/Shielded</p>  <p>LAK006</p>	<p>Snap</p>  <p>WHITE GREEN BLACK</p>
<p>RPI Part #LKM032</p> <p>5 LEADWIRE SET - 40" DUAL/PINCH</p> <ul style="list-style-type: none"> • Number of Leads: 5 • Length: 40" • Includes: 5 Lead Shielded Accessory Kit (RPI Part #LAK007) <p>Also available:</p> <ul style="list-style-type: none"> • Disposable Leadwire Set (RPI Part #LDM314) 	<p>Dual/Shielded</p>  <p>LAK007</p>	<p>Pinch</p>  <p>RED WHITE GREEN BLACK BROWN</p>
<p>RPI Part #LKM035</p> <p>5 LEADWIRE SET - 40" DUAL/SNAP</p> <ul style="list-style-type: none"> • Number of Leads: 5 • Length: 40" • Includes: 5 Lead Shielded Accessory Kit (RPI Part #LAK007) <p>Also available:</p> <ul style="list-style-type: none"> • Disposable Leadwire Set (RPI Part #LDM307) 	<p>Dual/Shielded</p>  <p>LAK007</p>	<p>Snap</p>  <p>RED WHITE GREEN BLACK BROWN</p>

General Biomedical Equipment

ECG, Monitoring & Defibrillators

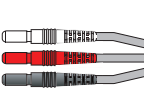
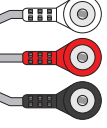
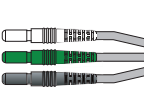
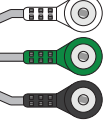
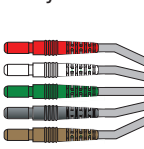
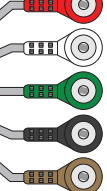
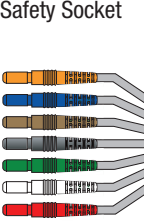
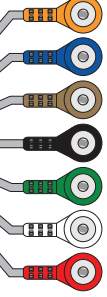
DISPOSABLE: DIN/UNSHIELDED LEADWIRE SETS

Accessories Also Available

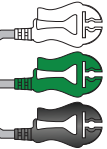
DESCRIPTION	EQUIPMENT END	PATIENT END
<p>RPI Part #LDM301</p> <p>3 LEADWIRE SET DISPOSABLE 24" DIN/SNAP</p> <ul style="list-style-type: none"> • Disposable; 10 sets per package • Number of Leads: 3 • Length: 24" <p>Also available:</p> <ul style="list-style-type: none"> • Reusable Leadwire Set (RPI Part #LKM005) & 3 Lead Organizer (RPI Part #LAR004) 	<p>Din/Unshielded; .060" Safety Socket</p> 	<p>Snap</p>  <p>WHITE RED BLACK</p>
<p>RPI Part #LDM302</p> <p>3 LEADWIRE SET DISPOSABLE 24" DIN/SNAP</p> <ul style="list-style-type: none"> • Disposable; 10 sets per package • Number of Leads: 3 • Length: 24" <p>Also available:</p> <ul style="list-style-type: none"> • Reusable Leadwire Set (RPI Part #LKM011) & 3 Lead Organizer (RPI Part #LAR004) 	<p>Din/Unshielded; .060" Safety Socket</p> 	<p>Snap</p>  <p>WHITE GREEN BLACK</p>
<p>RPI Part #LDM303</p> <p>5 LEADWIRE SET DISPOSABLE 24" DIN/SNAP</p> <ul style="list-style-type: none"> • Disposable; 10 sets per package • Number of Leads: 5 • Length: 24" <p>Also available:</p> <ul style="list-style-type: none"> • Reusable 24" Leadwire Set (RPI Part #LKM029), Reusable 40" Leadwire Set (RPI Part #LKM030) & 5 Lead Organizer (RPI Part #LAR005) 	<p>Din/Unshielded; .060" Safety Socket</p> 	<p>Snap</p>  <p>RED WHITE GREEN BLACK BROWN</p>
<p>RPI Part #LDM304</p> <p>7 LEADWIRE SET DISPOSABLE 24" DIN/SNAP</p> <ul style="list-style-type: none"> • Disposable; 10 sets per package • Number of Leads: 7 • Length: 24" <p>Also available:</p> <ul style="list-style-type: none"> • Reusable Leadwire Set (RPI Part #LKM041) 	<p>Din/Unshielded; .060" Safety Socket</p> 	<p>Snap</p>  <p>ORANGE BLUE BROWN BLACK GREEN WHITE RED</p>
<p>RPI Part #LDM308</p> <p>3 LEADWIRE SET DISPOSABLE 24" DIN/PINCH</p> <ul style="list-style-type: none"> • Disposable; 10 sets per package • Number of Leads: 3 • Length: 24" <p>Also available:</p> <ul style="list-style-type: none"> • Reusable Leadwire Set (RPI Part #LKM002) & 3 Lead Organizer (RPI Part #LAR004) 	<p>Din/Unshielded; .060" Safety Socket</p> 	<p>Pinch</p>  <p>WHITE RED BLACK</p>
<p>RPI Part #LDM309</p> <p>3 LEADWIRE SET DISPOSABLE 24" DIN/PINCH</p> <ul style="list-style-type: none"> • Disposable; 10 sets per package • Number of Leads: 3 • Length: 24" <p>Also available:</p> <ul style="list-style-type: none"> • Reusable Leadwire Set (RPI Part #LKM008) & 3 Lead Organizer (RPI Part #LAR004) 	<p>Din/Unshielded; .060" Safety Socket</p> 	<p>Pinch</p>  <p>WHITE GREEN BLACK</p>

(continued on next page)

Accessories Also Available

DISPOSABLE: DIN/UNSHIELDED LEADWIRE SETS (Continued)

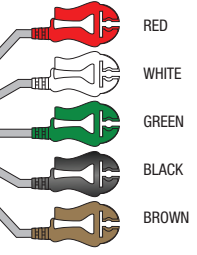
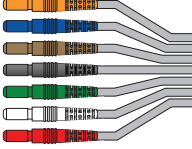
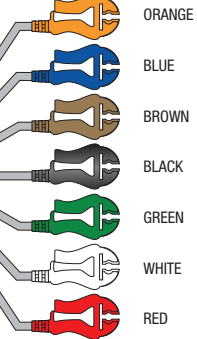
DESCRIPTION	EQUIPMENT END	PATIENT END
<p>RPI Part #LDM310</p> <p>5 LEADWIRE SET DISPOSABLE 24" DIN/PINCH</p> <ul style="list-style-type: none"> • Disposable; 10 sets per package • Number of Leads: 5 • Length: 24" <p>Also available:</p> <ul style="list-style-type: none"> • Reusable Leadwire Set (RPI Part #LKM026) & 5 Lead Organizer (RPI Part #LAR005) 	<p>Din/Unshielded; .060" Safety Socket</p> 	<p>Pinch</p> 
<p>RPI Part #LDM311</p> <p>7 LEADWIRE SET DISPOSABLE 24" DIN/PINCH</p> <ul style="list-style-type: none"> • Disposable; 10 sets per package • Number of Leads: 7 • Length: 24" <p>Also available:</p> <ul style="list-style-type: none"> • Reusable Leadwire Set (RPI Part #LKM038) 	<p>Din/Unshielded; .060" Safety Socket</p> 	<p>Pinch</p> 

Accessories Also Available

DISPOSABLE: DUAL/SHIELDED LEADWIRE SETS

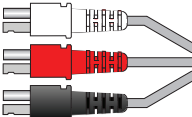
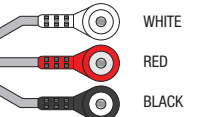
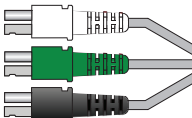
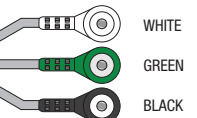
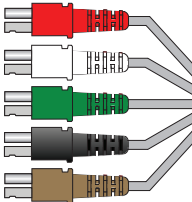
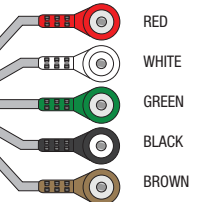
DESCRIPTION	EQUIPMENT END	PATIENT END
<p>RPI Part #LDM305</p> <p>3 LEADWIRE SET DISPOSABLE 30" DUAL/SNAP</p> <ul style="list-style-type: none"> • Disposable; 10 sets per package • Number of Leads: 3 • Length: 30" <p>Also available:</p> <ul style="list-style-type: none"> • Reusable Leadwire Set (RPI Part #LKM017) & 3 Lead Shielded Accessory Kit (RPI Part #LAK006) 	<p>Dual/Shielded</p> 	<p>Snap</p> 
<p>RPI Part #LDM306</p> <p>3 LEADWIRE SET DISPOSABLE 30" DUAL/SNAP</p> <ul style="list-style-type: none"> • Disposable; 10 sets per package • Number of Leads: 3 • Length: 30" <p>Also available:</p> <ul style="list-style-type: none"> • Reusable Leadwire Set (RPI Part #LKM023) & 3 Lead Shielded Accessory Kit (RPI Part #LAK006) 	<p>Dual/Shielded</p> 	<p>Snap</p> 
<p>RPI Part #LDM307</p> <p>5 LEADWIRE SET DISPOSABLE 30" DUAL/SNAP</p> <ul style="list-style-type: none"> • Disposable; 10 sets per package • Number of Leads: 5 • Length: 30" <p>Also available:</p> <ul style="list-style-type: none"> • Reusable Leadwire Set (RPI Part #LKM035) & 5 Lead Shielded Accessory Kit (RPI Part #LAK007) 	<p>Dual/Shielded</p> 	<p>Snap</p> 

(continued on next page)

General Biomedical Equipment

ECG, Monitoring & Defibrillators

DISPOSABLE: DUAL/SHIELDED LEADWIRE SETS (Continued)



DESCRIPTION	EQUIPMENT END	PATIENT END
<p>RPI Part #LDM312</p> <p>3 LEADWIRE SET DISPOSABLE 30" DUAL/PINCH</p> <ul style="list-style-type: none"> • Disposable; 10 sets per package • Number of Leads: 3 • Length: 30" <p>Also available:</p> <ul style="list-style-type: none"> • Reusable Leadwire Set (RPI Part #LKM014) & 3 Lead Shielded Accessory Kit (RPI Part #LAK006) 	<p>Dual/Shielded</p>	<p>Pinch</p> <p>WHITE RED BLACK</p>
<p>RPI Part #LDM313</p> <p>3 LEADWIRE SET DISPOSABLE 30" DUAL/PINCH</p> <ul style="list-style-type: none"> • Disposable; 10 sets per package • Number of Leads: 3 • Length: 30" <p>Also available:</p> <ul style="list-style-type: none"> • Reusable Leadwire Set (RPI Part #LKM020) & 3 Lead Shielded Accessory Kit (RPI Part #LAK006) 	<p>Dual/Shielded</p>	<p>Pinch</p> <p>WHITE GREEN BLACK</p>
<p>RPI Part #LDM314</p> <p>5 LEADWIRE SET DISPOSABLE 30" DUAL/PINCH</p> <ul style="list-style-type: none"> • Disposable; 10 sets per package • Number of Leads: 5 • Length: 30" <p>Also available:</p> <ul style="list-style-type: none"> • Reusable Leadwire Set (RPI Part #LKM032) & 5 Lead Shielded Accessory Kit (RPI Part #LAK007) 	<p>Dual/Shielded</p>	<p>Pinch</p> <p>RED WHITE GREEN BLACK BROWN</p>



ACCESSORIES

DESCRIPTION	ACCESSORY
<p>RPI Part #LAC002</p> <p>3 LEAD COMBINER</p> <ul style="list-style-type: none"> • Number of Leads: 3 • Use with Dual/Shielded Leadwires only <p>Also included in:</p> <ul style="list-style-type: none"> • 3 Lead Shielded Accessory Kit (RPI Part #LAK006) 	
<p>RPI Part #LAR004</p> <p>3 LEAD ORGANIZER</p> <ul style="list-style-type: none"> • Number of Leads: 3 <p>Also included in:</p> <ul style="list-style-type: none"> • 3 Lead Shielded Accessory Kit (RPI Part #LAK006) 	
<p>RPI Part #LAK006</p> <p>3 LEAD SHIELDED ACCESSORY KIT</p> <ul style="list-style-type: none"> • Number of Leads: 3 • Shielded Accessory Kit • Use with Dual/Shielded Leadwires only • Includes all parts as shown 	<p>LAR004 LAC002</p>

DESCRIPTION	ACCESSORY
<p>RPI Part #LAC003</p> <p>5 LEAD COMBINER</p> <ul style="list-style-type: none"> • Number of Leads: 5 • Use with Dual/Shielded Leadwires only <p>Also included in:</p> <ul style="list-style-type: none"> • 5 Lead Shielded Accessory Kit (RPI Part #LAK007) 	
<p>RPI Part #LAR005</p> <p>5 LEAD ORGANIZER</p> <ul style="list-style-type: none"> • Number of Leads: 5 <p>Also included in:</p> <ul style="list-style-type: none"> • 5 Lead Shielded Accessory Kit (RPI Part #LAK007) 	
<p>RPI Part #LAK007</p> <p>5 LEAD SHIELDED ACCESSORY KIT</p> <ul style="list-style-type: none"> • Number of Leads: 5 • Shielded Accessory Kit • Use with Dual/Shielded Leadwires only • Includes all parts as shown 	<p>LAR005 LAC003</p>

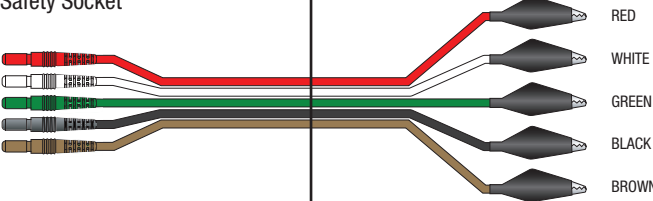
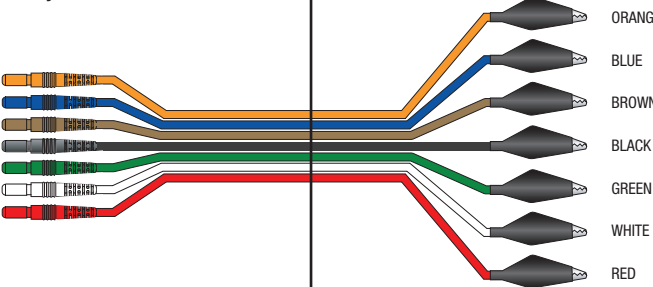

VETERINARY: DIN/UNSHIELDED LEADWIRE SETS

DESCRIPTION	EQUIPMENT END	PATIENT END
RPI Part #LVM701 3 LEADWIRE SET - 24" DIN/ALLIGATOR <ul style="list-style-type: none"> • Number of Leads: 3 • Length: 24" • Recommended for veterinary use only Also available: <ul style="list-style-type: none"> • 3 Lead Organizer (RPI Part #LAR004) 	Din/Unshielded; .060" Safety Socket 	Alligator Clip WHITE RED BLACK
RPI Part #LVM702 3 LEADWIRE SET - 24" DIN/ALLIGATOR <ul style="list-style-type: none"> • Number of Leads: 3 • Length: 24" • Recommended for veterinary use only Also available: <ul style="list-style-type: none"> • 3 Lead Organizer (RPI Part #LAR004) 	Din/Unshielded; .060" Safety Socket 	Alligator Clip WHITE GREEN BLACK
RPI Part #LVM703 5 LEADWIRE SET - 24" DIN/ALLIGATOR <ul style="list-style-type: none"> • Number of Leads: 5 • Length: 24" • Recommended for veterinary use only Also available: <ul style="list-style-type: none"> • 5 Lead Organizer (RPI Part #LAR005) 	Din/Unshielded; .060" Safety Socket 	Alligator Clip RED WHITE GREEN BLACK BROWN
RPI Part #LVM704 7 LEADWIRE SET - 24" DIN/ALLIGATOR <ul style="list-style-type: none"> • Number of Leads: 7 • Length: 24" • Recommended for veterinary use only Also available: <ul style="list-style-type: none"> • 3 Lead Organizer (RPI Part #LAR004) & • 5 Lead Organizer (RPI Part #LAR005) 	Din/Unshielded; .060" Safety Socket 	Alligator Clip ORANGE BLUE BROWN BLACK GREEN WHITE RED

VETERINARY: DUAL/SHIELDED LEADWIRE SETS



DESCRIPTION	EQUIPMENT END	PATIENT END
RPI Part #LVM705 3 LEADWIRE SET - 30" DUAL/ALLIGATOR <ul style="list-style-type: none"> • Number of Leads: 3 • Length: 30" • Recommended for veterinary use only Also available: <ul style="list-style-type: none"> • 3 Lead Shielded Accessory Kit (RPI Part #LAK006) 	Dual/Shielded 	Alligator Clip WHITE RED BLACK

(continued on next page)

General Biomedical Equipment

ECG, Monitoring & Defibrillators

VETERINARY: DUAL/SHIELDED LEADWIRE SETS (Continued)



DESCRIPTION	EQUIPMENT END	PATIENT END
RPI Part #LVM706 3 LEADWIRE SET - 30" DUAL/ALLIGATOR <ul style="list-style-type: none"> • Number of Leads: 3 • Length: 30" • Recommended for veterinary use only Also available: <ul style="list-style-type: none"> • 3 Lead Shielded Accessory Kit (RPI Part #LAK006) 	Dual/Shielded 	Alligator Clip
RPI Part #LVM707 5 LEADWIRE SET - 30" DUAL/ALLIGATOR <ul style="list-style-type: none"> • Number of Leads: 5 • Length: 30" • Recommended for veterinary use only Also available: <ul style="list-style-type: none"> • 5 Lead Shielded Accessory Kit (RPI Part #LAK007) 	Dual/Shielded 	Alligator Clip

VETERINARY: INDIVIDUAL LEADWIRES

DIN/UNSHIELDED		DUAL/SHIELDED	
<ul style="list-style-type: none"> • Equipment End: Din/Unshielded, .060 Safety Socket • Patient End: Alligator Clip • Length: 24" 		<ul style="list-style-type: none"> • Equipment End: Dual/Shielded • Patient End: Alligator Clip • Length: 30" 	
DESCRIPTION	LEADWIRE COLOR	DESCRIPTION	LEADWIRE COLOR
RPI Part #LGB002 LEADWIRE BLACK 24" DIN/ALLIGATOR	Black	RPI Part #LGB004 LEADWIRE BLACK 30" DUAL/ALLIGATOR	Black
RPI Part #LGE002 LEADWIRE ORANGE 24" DIN/ALLIGATOR	Orange	RPI Part #LGG004 LEADWIRE GREEN 30" DUAL/ALLIGATOR	Green
RPI Part #LGG002 LEADWIRE GREEN 24" DIN/ALLIGATOR	Green	RPI Part #LGN004 LEADWIRE BROWN 30" DUAL/ALLIGATOR	Brown
RPI Part #LGN002 LEADWIRE BROWN 24" DIN/ALLIGATOR	Brown	RPI Part #LGR004 LEADWIRE RED 30" DUAL/ALLIGATOR	Red
RPI Part #LGR002 LEADWIRE RED 24" DIN/ALLIGATOR	Red	RPI Part #LGW004 LEADWIRE WHITE 30" DUAL/ALLIGATOR	White
RPI Part #LGU002 LEADWIRE BLUE 24" DIN/ALLIGATOR	Blue	Depending on equipment model, these leadwires are also available as sets – see <i>VETERINARY: DIN/UNSHIELDED LEADWIRE SETS</i> and <i>VETERINARY: DUAL/SHIELDED LEADWIRE SETS</i> on previous page.	
RPI Part #LGW002 LEADWIRE WHITE 24" DIN/ALLIGATOR	White		



RPI Part #WAB001
OEM Part #747284-501
POWER SUPPLY BOARD (3.5V)

- 3.5VDC
- Includes all parts as shown
- Also available: Position Control Knob (RPI Part #BUK043)

Fits: Chassis
Model: 74710

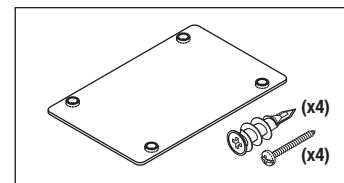
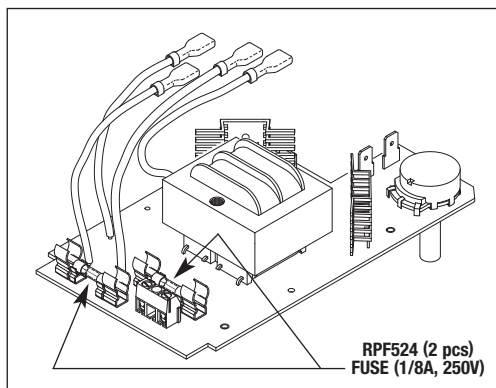

RPI Part #WAB004
OEM Part #747145
WALL BRACKET

- Size: 4.16" lg. x 3.0" wd. x .06" thk.
- Material: Aluminum
- Includes: Mounting hardware

Fits: Mounting Plate
Model: 74710

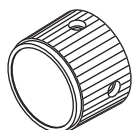

RPI Part #BUK043
OEM Part #747116-1
POSITION CONTROL KNOB

- Material: Black plastic knob, aluminum face plate
- Size: .92" OD x .64" lg.
- Shaft Size: 1/4" dia.
- Includes: (2) installed set screws

Fits: Control Panel
Model: 74710

RPI Part #RPF524
OEM Part #711571-1
FUSE (1/8A, 250V) - TIME DELAY

- 5 per package
- Type: Glass
- Size: 5mm dia. x 20mm lg.
- Included in: Power Supply Board (3.5V) (RPI Part #WAB001) and Fuse Kit (RPI Part #RPK538)

Fits: Power Supply Board
Model: 74710

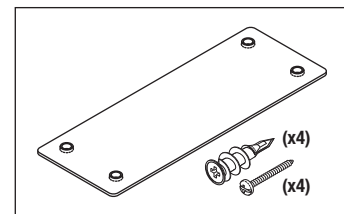
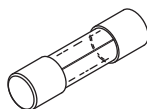

RPI Part #WAB007
OEM Part #767035-501
WALL BRACKET

- Size: 6.0" lg. x 2.2" wd. x .06" thk.
- Material: Aluminum
- Includes: Mounting hardware

Fits: Mounting Plate
Model: 767



RPI Part #WAK003
OEM Part #747300-501
 (Complete Handpiece Assembly)

COILED CORD KIT

- Size: 2 Conductor #20 AWG x ~3 ft. lg.
- Includes all parts as shown
- Now you can replace just the Coiled Cord instead of the whole Handpiece Assembly - It's the RPI Advantage!
- Also available: Strain Relief Bushing Pliers (RPI Part #RPT172)

Fits: Handpiece
Model: 74710

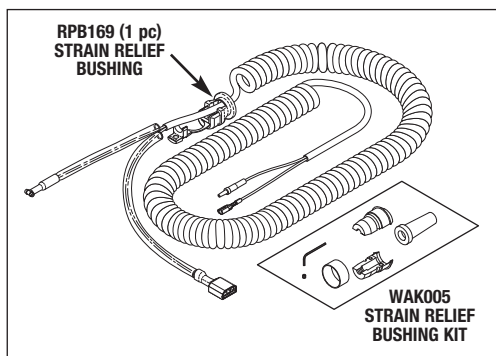

RPI Part #WAS002
OEM Part #747014-2

MICROSWITCH

- Momentary
- 4A @ 250VAC; SPDT
- .058" dia. Pin Terminals

Fits: Handle Mounting Bracket
Model: 74710

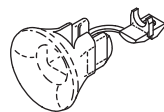
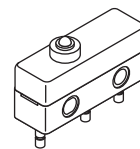

RPI Part #RPB169
OEM Part #745184
STRAIN RELIEF BUSHING

- 8 per package
- Type: SR-5N-5
- Accommodates: .250" - .290" dia. round Cord
- Mounting Hole: 1/2" dia.
- Included in: Strain Relief Bushing Kit (RPI Part #RPK412) and Coiled Cord (RPI Part #WAK003)
- Also available: Strain Relief Bushing Pliers (RPI Part #RPT172)

Fits: Handpiece Coiled Cord
Models: 74710

RPI Part #WAK005
OEM Part #
 (No OEM Part # Available)

STRAIN RELIEF BUSHING KIT

- Fits .190" dia. cord
- Includes: Bushing, rubber boot, dress ring, set screw and .035" hex wrench
- Now you can reset the handpiece without replacing the entire coiled cord - It's the RPI Advantage!
- Included in: Coiled Cord (RPI Part WAK003)

Fits: Handpiece Coiled Cord
Model: 74710

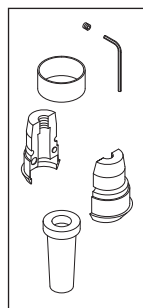

RPI Part #TUS009
OEM Part #483311-2
POWER SWITCH

- Rocker switch (On-Off)
- 20A @ 125/250VAC; DPST
- Color: Black body with illuminated green lens; Legend: I/O
- 1/4" Tabs

Fits: Main Housing
Model: 74710

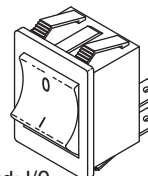

RPI Part #WAS008
OEM Part #236707-1

POWER SWITCH

- Rocker Switch (ON - OFF)
- 16A @ 250VAC; DPST
- Color: Black body with illuminated green lens
- 1/4" Tabs

Fits: Main Housing
Model: 767

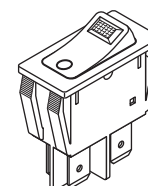

General Biomedical Equipment

Models: 74710 & 767

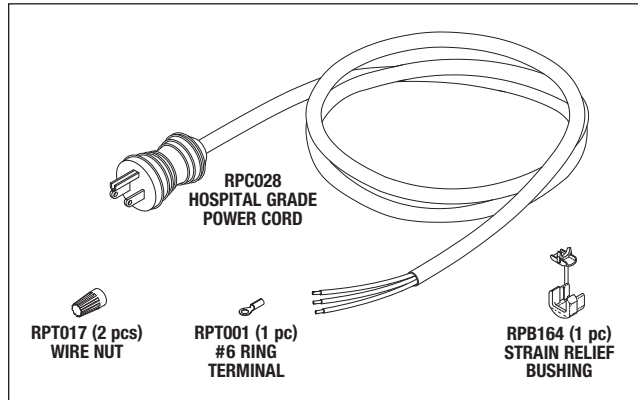

RPI Part #CAK120
OEM Part #747306-501 (Power Cord only)/711314 (Strain Relief only)

POWER CORD KIT

- Length: 8 ft.; Color: Gray
- 18/3 SJT, 60°C; 10A @ 125VAC
- Plug: NEMA 5-15P; Connector: None
- Includes all parts as shown
- Also available: Strain Relief Bushing Pliers (RPI Part #RPT172)

Fits: Chassis
Model: 74710

RPI Part #RPB164
OEM Part # (No OEM Part # Available)

STRAIN RELIEF BUSHING

- 8 per package
- Type: SR-6N3-4
- Accommodates: .325" - .360" dia. round cord
- Mounting Hole: 5/8" dia. x 1/8" thk. panel max.
- Included in: Strain Relief Bushing Kit (RPI Part #RPK412)
- Also available: Strain Relief Bushing Pliers (RPI Part #RPT172)

Fits: Power Cord
Models: 74710

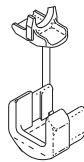

RPI Part #RPC557
OEM Part #761069

HOSPITAL GRADE POWER CORD

- Length: 8 ft.; Color: Gray
- 16/3 SJT, 60°C; 13A @ 125VAC
- Plug: NEMA 5-15P
- Connector: EN60320-C13

Fits: Power Input Module
Model: 767

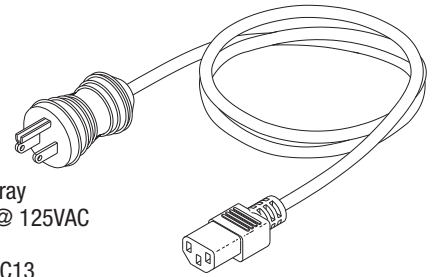

RPI Part #RPF508
OEM Part #236706-3111

FUSE (1/4A, 250V) - FAST ACTING

- 5 per package
- Type: Glass
- Size: 5mm dia. x 20mm lg.
- Included in: Fuse Kit (RPI Part #RPK520)

Fits: Power Supply Board
Model: 767

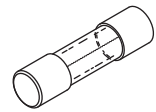

RPI Part #RPT172
OEM Part # (No OEM Part # Available)

STRAIN RELIEF BUSHING PLIERS

- Hand pliers adjustable for all strain relief bushings that assemble into mounting hole up to 7/8" diameter
- Size: 7" lg.
- Also available: Strain Relief Bushing Kit (RPI Part #RPK412)

Models: 74710

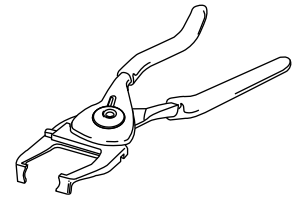

Lamps for Exam Heads

RPI Part #LMP109
OEM Part #WA-03100-U

LAMP

- 6 per package
- 3.5V, 2.52W
- Shape: T1.5; Xenon

Fits: Examination Head

Models: 20000 Otoscope, 20200 Otoscope, 20202 Otoscope, 21700 Otoscope, 25000 Otoscope, 25020 Otoscope, 25200 Otoscope, 26530 Illuminator, 27000 Illuminator, 27050 Illuminator, 28100 Tongue Blade Holder, 41100 Illuminator, 43300 Illuminator & 73500 Handle Adapter

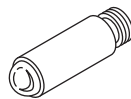

RPI Part #LMP110
OEM Part #WA-03000-U

LAMP

- 6 per package
- 3.5V, 2.52W
- Shape: T1.5; Xenon
- Single contact 8mm flange

Fits: Examination Head

Models: 11600 Ophthalmoscope, 11605 Ophthalmoscope, 11610 Ophthalmoscope, 11710 Ophthalmoscope, 12400 Strabismoscope, 18000 Retinoscope & 43700 Episcopes

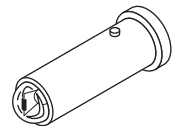

RPI Part #LMP111
OEM Part #WA-06500-U

LAMP

- 6 per package
- 3.5V, 2.73W
- Shape: TL1.5; Xenon

Fits: Examination Head

Models: 23810 Otoscope & 23820 Otoscope

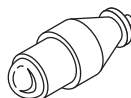

RPI Part #LMP112
OEM Part #WA-03800-U

LAMP

- 6 per package
- 3.5V, 2.33W
- Shape: T1.5; Xenon

Fits: Examination Head

Models: 11800 Ophthalmoscope, 11810 Ophthalmoscope & 11820 Ophthalmoscope

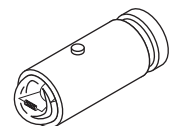

Models: Force 1C, Force 2-2, Force 2-8, Force 4, Force 30, Force 40, Force EZ, Force EZ-C, Force EZ-8, Force EZ-8C, Force FX, Force FX-C, Force FX-8, Force FX-8C & Force Triad

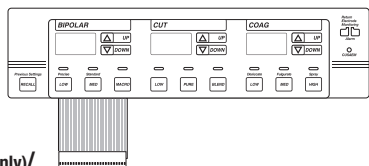

RPI Part #CVP012
OEM Part #1012634 (Keypad Only)/
223 200 667 (Control Panel Only)

KEYPAD (FRONT PANEL)

- Includes: Front panel keypad and control panel
- Size: 3.34" x 13.44"
- Adhesive backing
- Also available: Overlay (Connector Panel) (RPI Part #CVP013)

Fits: Front Panel

Models: Force FX & Force FX-C

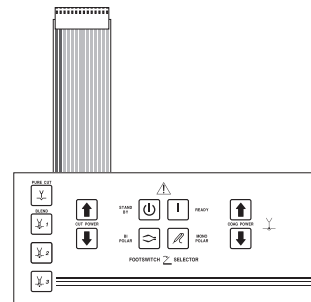

RPI Part #CVP008
OEM Part #207 500 147

KEYPAD (MONOPOLAR)

- Size: 3.50" x 8.00"
- Material: Anodized aluminum backing panel

• Also available: Adhesive (RTV108) (RPI Part #RPA874)

Fits: Front Control Panel

Models: Force 2-2

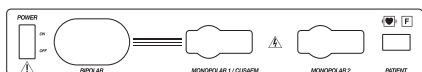

RPI Part #CVP013
OEM Part #1020029

OVERLAY (CONNECTOR PANEL)

- Size: 2.12" x 13.44"
- Adhesive backing
- Also available: Keypad (Front Panel) (RPI Part #CVP012)

Fits: Front Panel

Models: Force FX & Force FX-C

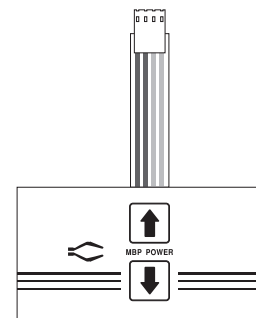

RPI Part #CVP009
OEM Part #207 500 148

KEYPAD (BIPOLAR)

- Size: 1.75" x 3.25"
- Material: Anodized aluminum backing panel

• Also available: Adhesive (RTV108) (RPI Part #RPA874)

Fits: Front Control Panel

Models: Force 2-2

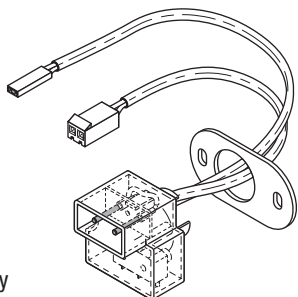

RPI Part #CVA016
OEM Part #202 701 854

RETURN MODULE ASSEMBLY

- Replacement for the REM® Assembly
- Switch: 0.1A @ 125/250V, 50/60 Hz.

Fits: Front Panel

Models: Force 30, Force 40, Force FX, Force FX-C, Force FX-8 & Force FX-8C

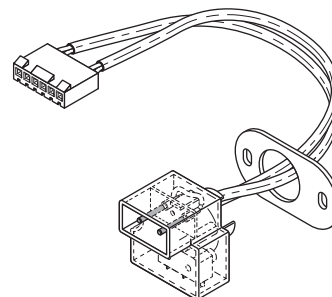

RPI Part #CVA015
OEM Part # (No OEM Part # Available)

RETURN MODULE ASSEMBLY

- Replacement for the REM® Assembly
- Switch: 0.1A @ 125/250V, 50/60 Hz.

Fits: Front Panel

Models: Force 2-2

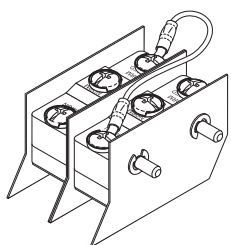

RPI Part #CVA001
OEM Part # (No OEM Part # Available)

FOOTSWITCH ASSEMBLY

- Monopolar
- 20A @ 125/250VAC

Fits: E6008 Monopolar Footswitch

Models: Force 1C, Force 2-2, Force 2-8, Force 4, Force 30, Force 40, Force EZ, Force EZ-C, Force EZ-8, Force EZ-8C, Force FX, Force FX-C, Force FX-8, Force FX-8C & Force Triad

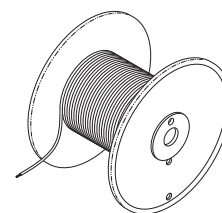

RPI Part #RPW906
OEM Part # (No OEM Part # Available)

HOOK UP WIRE (BLACK)

- Sold by the foot (reel **not** included)
- #18 AWG, 16/30 strands, UL 1569
- Insulation: PVC; 221°F (105°C); 300V
- For use with Footswitch Assembly (RPI Part #CVA001)

Fits: E6008 Monopolar Footswitch

Models: Force 1C, Force 2-2, Force 2-8, Force 4, Force 30, Force 40, Force EZ, Force EZ-C, Force EZ-8, Force EZ-8C, Force FX, Force FX-C, Force FX-8, Force FX-8C & Force Triad

General Biomedical Equipment

Models: Force 1C, Force 2-2, Force 2-8, Force 4, Force 30, Force 40, Force EZ, Force EZ-C, Force EZ-8, Force EZ-8C, Force FX, Force FX-C, Force FX-8, Force FX-8C & Force Triad

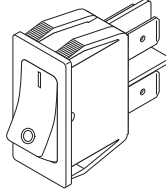

RPI Part #CVS014
OEM Part #243 025 037

POWER SWITCH

- Rocker Switch (On-Off)
- 16A @ 125/250VAC; DPST
- Black body and rocker
- 1/4" Tabs
- Panel Cutout: .480" x 1.071"

Fits: Front Control Panel
Models: Force FX & Force FX-C

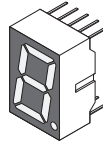

RPI Part #LMD036
OEM Part #239 750 071

NUMERIC DISPLAY LED

- 3 per package
- 7 Segment display (green)
- Character height: 14.2mm (.56")
- Configuration: 10 Pin DIP

Fits: Display Board
Models: Force FX & Force FX-C

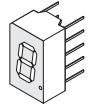

RPI Part #LMD031
OEM Part #239 750 029

NUMERIC DISPLAY LED

- 3 per package
- 7 Segment display (red)
- Character height: 7.62mm (.30")
- Configuration: 10 Pin DIP

Fits: Display Board
Models: Force 2-2

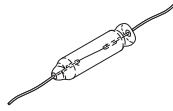

RPI Part #LMP030
OEM Part #215 200 085

LAMP

- 4 per package
- 12V, .055A, .66W; Axial Lead
- Type: Incandescent
- Can be used in place of radial lead bulb

Fits: Display Board
Models: Force FX, Force FX-C & Force 2-2

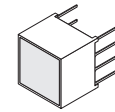

YELLOW/GREEN & RED

RPI Part #LMD037
OEM Part #239 750 076

LED INDICATOR (MULTI)

- 3 per package
- Bi-color display (yellow/green and red)
- Configuration: 8 Pin DIP

Fits: Display Board
Models: Force FX & Force FX-C

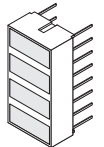

YELLOW

RPI Part #LMD032
OEM Part #239 750 022

LED LIGHT BAR

- Color: 4 Yellow light emitting sections
- Configuration: 16 Pin DIP

Fits: Display Board
Models: Force 2-2

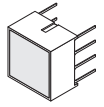

GREEN

RPI Part #LMD033
OEM Part #239 750 039

LED INDICATOR (GREEN)

- 3 per package
- Configuration: 8 Pin DIP

Fits: Display Board
Models: Force 2-2

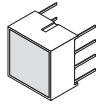

RED

RPI Part #LMD034
OEM Part #239 750 042

LED INDICATOR (RED)

- 3 per package
- Configuration: 8 Pin DIP

Fits: Display Board
Models: Force 2-2

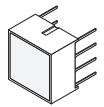

YELLOW

RPI Part #LMD035
OEM Part #239 750 033

LED INDICATOR (YELLOW)

- 3 per package
- Configuration: 8 Pin DIP

Fits: Display Board
Models: Force 2-2



RPI Part #CVA010
OEM Part #202 701 890

LINE FILTER ASSEMBLY

- 5mm dia. x 20mm lg. fuses not included
- 10A @ 125/250VAC, 50-60 Hz.
- Also available:
 - Fuse (8A, 250V) (RPI Part #RPF535) to fit 120VAC Force FX and Force FX-C and
 - Fuse (4A, 250V) (RPI Part #RPF533) to fit 220VAC Force FX-8 and Force FX-8C

Fits: Rear Panel
Models: Force FX, Force FX-C, Force FX-8 & Force FX-8C

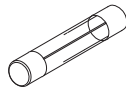
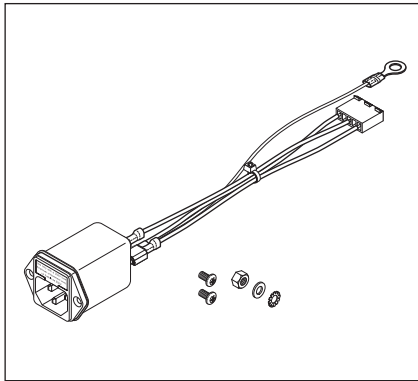

RPI Part #RPF535
OEM Part #215 100 074

FUSE (8A, 250V) - TIME DELAY

- 5 per package
- Type: Glass, Time Delay
- Size: 5mm dia. x 20mm lg.
- Included in: Fuse Kit (RPI Part #RPK538)

Fits: Line Filter Assembly in 120V Units
Models: Force FX and Force FX-C

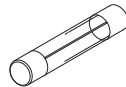

RPI Part #RPF533
OEM Part #215 100 074

FUSE (4A, 250V) - TIME DELAY

- 5 per package
- Type: Glass, Time Delay
- Size: 5mm dia. x 20mm lg.
- Included in: Fuse Kit (RPI Part #RPK538)

Fits: Line Filter Assembly in 220V Units
Models: Force FX-8 and FX-8C

Models: Force 1C, Force 2-2, Force 2-8, Force 4, Force 30, Force 40, Force EZ, Force EZ-C, Force EZ-8, Force EZ-8C, Force FX, Force FX-C, Force FX-8, Force FX-8C & Force Triad



RPI Part #CVA007
OEM Part # (No OEM Part # Available)
VOLUME CONTROL ASSEMBLY

- 100 Ω Potentiometer
- 19" lg. wires with connector
- Includes all parts as shown

Fits: Rear Panel
Models: Force 2-2

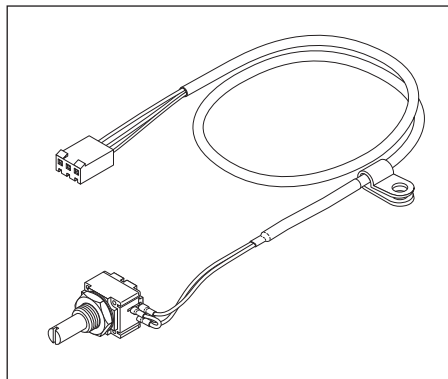

CVR004
CVR003

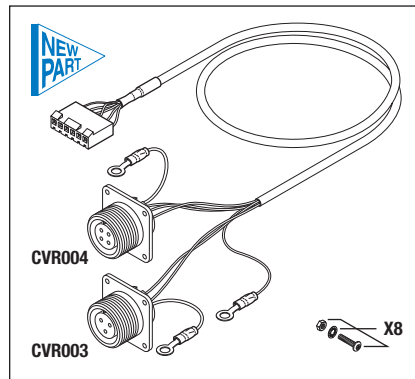

RPI Part #CVA002
OEM Part # (No OEM Part # Available)

FOOTSWITCH RECEPTACLE ASSEMBLY

- 25" lg. shielded cable
- Includes all parts as shown

Fits: Rear Panel
Models: Force 2-2



RPI Part #CVA005
OEM Part # (No OEM Part # Available)
POWER HARNESS ASSEMBLY

- Includes all parts as shown

Fits: Rear Panel to Transformer
Models: Force 2-2

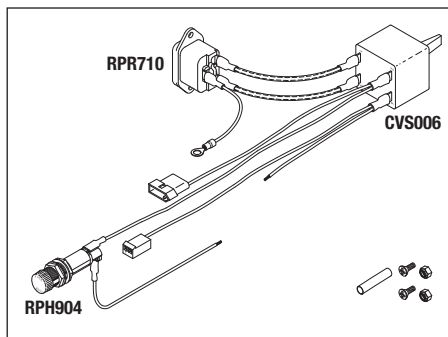

RPI Part #CVR003
OEM Part # (No OEM Part # Available)

BIPOLAR RECEPTACLE

- 3-Socket receptacle
- Material: Aluminum body, clear finish
- Termination style: Solder
- Included in: Footswitch Receptacle Assembly (RPI Part #CVA002)

Fits: Rear Panel
Models: Force 1C, Force 2-2, Force 2-8, Force 4, Force 30, Force 40, Force EZ, Force EZ-C, Force EZ-8, Force EZ-8C, Force FX, Force FX-C, Force FX-8, Force FX-8C & Force Triad

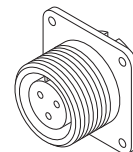

RPI Part #CVS006
OEM Part # (No OEM Part # Available)
POWER SWITCH/CIRCUIT BREAKER

- Toggle Switch (On-Off); 12.5A circuit breaker
- 12.5A @ 125/250VAC, 50/60 Hz.
- 1/4" Tabs
- Mounting hole size: .500" dia.
- Includes: Mounting hardware
- Included in: Power Harness Assembly (RPI Part #CVA005)

Fits: Rear Panel
Models: Force 2-2

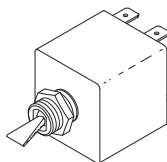

RPI Part #RPH904
OEM Part # (No OEM Part # Available)
FUSE HOLDER

- Accommodates standard 1/4" x 1-1/4" fuse
- 20A @ 250VAC
- 1/4" Tabs; Black body
- Mounting hole size: .500" dia.; Mounts through front or rear of panel
- Includes: Mounting hardware
- Included in: Power Harness Assembly (RPI Part #CVA005)
- Also available: Fuse (1A, 250V) (RPI Part #RPF045)

Fits: Rear Panel
Models: Force 2-2

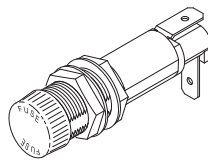

RPI Part #CVR004
OEM Part # (No OEM Part # Available)

MONOPOLAR RECEPTACLE

- 4-Socket receptacle
- Material: Aluminum body, clear finish
- Termination style: Solder
- Included in: Footswitch Receptacle Assembly (RPI Part #CVA002)

Fits: Rear Panel
Models: Force 1C, Force 2-2, Force 2-8, Force 4, Force 30, Force 40, Force EZ, Force EZ-C, Force EZ-8, Force EZ-8C, Force FX, Force FX-C, Force FX-8, Force FX-8C & Force Triad

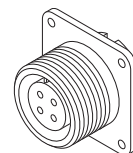

RPI Part #RPR710
OEM Part # (No OEM Part # Available)
AC INLET RECEPTACLE

- 15A @ 125VAC; 1/4" Tabs
- Keyed Mating Feature
- Includes: (2) sets of mounting hardware
- Fits panel cut-out: .787" x 1.083"
- Included in: Power Harness Assembly (RPI Part #CVA005)

Models: Force 2-2

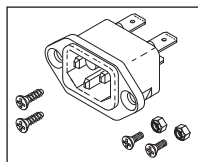

RPI Part #RPF045
OEM Part # (No OEM Part # Available)
FUSE (1A, 250V) FAST ACTING

- 5 per package
- Type: Glass, AGC Fast Acting
- Size: 1/4" dia. x 1-1/4" lg.
- Included in: Fuse Kit (RPI Part #RPK410)

Fits: Fuse Holder (RPI Part #RPH904)
Models: Force 2-2

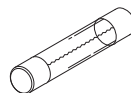

General Biomedical Equipment

Models: Force 1C, Force 2-2, Force 2-8, Force 4, Force 30, Force 40, Force EZ, Force EZ-C, Force EZ-8, Force EZ-8C, Force FX, Force FX-C, Force FX-8, Force FX-8C & Force Triad

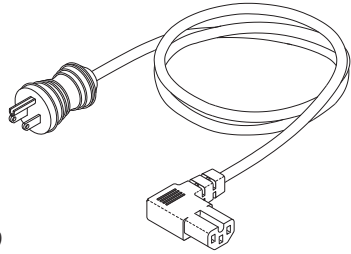

RPI Part #RPC881
OEM Part # (No OEM Part # Available)

HOSPITAL GRADE POWER CORD

- Length: 15 ft.; Color: Gray
- 16/3 SJT, 105°C, 13A @ 125VAC
- Plug Type: NEMA 5-15P; Clear
- Connector Type: EN60320-C15 Right Angle (keyed mating feature)

Fits: Power Entry Module

Models: Force 2-2

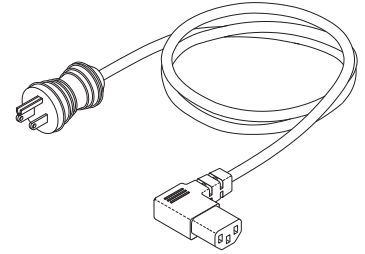

RPI Part #RPC784
OEM Part #207 002 060

HOSPITAL GRADE POWER CORD

- Length: 18 ft.; Color: Gray
- 16/3 SJT, 105°C, 13A @ 125VAC
- Plug Type: NEMA 5-15P
- Connector Type: EN60320-C13R

Models: Force FX and Force FX-C

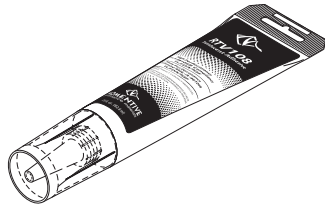

RPI Part #RPA874
OEM Part # (No OEM Part # Available)

ADHESIVE (RTV108)

- Size: 2.8 fl. oz. tube
- Translucent silicone adhesive/sealant
- Temperature Range: -75°F to +400°F

Models: Force 2-2

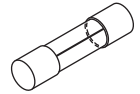

RPI Part #RPF882
OEM Part #215 100 041

FUSE (6.3A, 250V) - 5mm x 20mm - FAST ACTING

- 5 per package
- Type: Glass, AGC Fast Acting
- Size: 5mm dia. x 20mm lg.

Fits: Power Supply/RF Board

Models: Force 2-8, Force 30, Force 40, Force EZ, Force EZ-C, Force EZ-8, Force EZ-8C, Force FX, Force FX-C, Force FX-8 & Force FX-8C

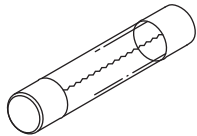

RPI Part #RPF052
OEM Part #215 005 039

FUSE (6A, 250V) - 1/4 x 1-1/4 - FAST ACTING

- 5 per package
- Type: Glass, AGC Fast Acting
- Size: 1/4" dia. x 1-1/4" lg.
- Included in: Fuse Kit (RPI Part #RPK410)

Fits: Power Supply/RF board

Models: Force 2-2 & Force 4

RPI Part #RPF367
OEM Part # (No OEM Part # Available)

FUSE (2A, 250V) - 5mm x 20mm - FAST ACTING

- 5 per package
- Type: Glass, AGC Fast Acting
- Size: 5mm dia. x 20mm lg.
- Included in: Fuse Kit (RPI Part #RPK520)

Fits: Force FX-C with Low Voltage Boards

Models: Force FX-C

NOTES: _____



New Line of Parts to fit Covidien/Puritan Bennett™ 840 Ventilators!



RPI Part #CVK501
OEM Part #4-079056-00

VENTILATOR PM KIT (WITH LAMPS - 9.4" GUI)

- 10,000 hour Planned Maintenance Kit
- Includes: Air Inlet Filter (RPI Part #CVF502), Oxygen Inlet Filter (RPI Part #CVF503), Lamp (RPI Part #CVL505), and PM Sticker

Models: 840

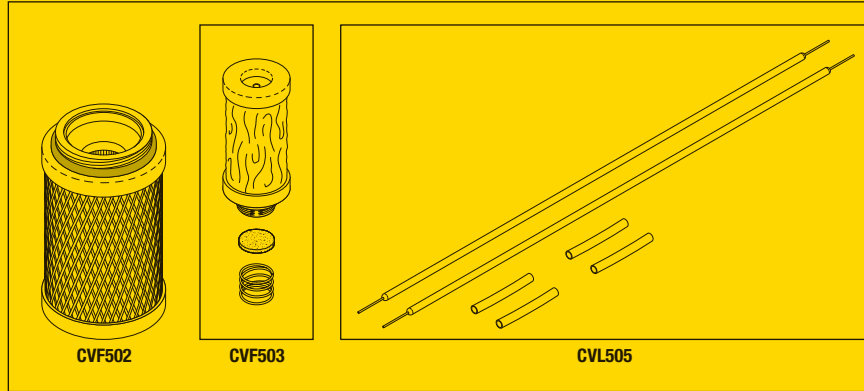

CVF502

CVF503

CVL505



RPI Part #CVK500
OEM Part #4-078179-00

VENTILATOR PM KIT (10.4" GUI)

- 10,000 hour Planned Maintenance Kit
- Includes: Air Inlet Filter (RPI Part #CVF502), Oxygen Inlet Filter (RPI Part #CVF503), and PM Sticker

Models: 840

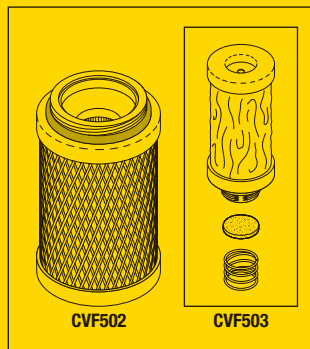

CVF502

CVF503

RPI Part #CVF502
OEM Part #4-072203-00

AIR INLET FILTER

- 0.3 micron
- Size: 1-3/4" dia. x 2-3/4" lg.
- Included in: Ventilator PM Kit (10.4" GUI) (RPI Part #CVK500) and Ventilator PM Kit (with Lamps - 9.4" GUI) (RPI Part #CVK501)
- Also available: Oxygen Inlet Filter (RPI Part #CVF503) and Lamp (RPI Part #CVL505)

Fits: Inspiratory Module

Models: 840

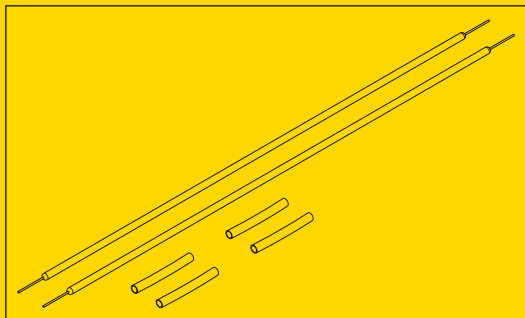
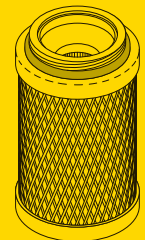

RPI Part #CVL505
OEM Part # (OEM Part # Not Available)

LAMP

- 2 per package
- Size: 2.6 mm (.102" dia.) x 214 mm (8.43" lg.) full spectrum CCFL
- Included in: Ventilator PM Kit (with Lamps - 9.4" GUI) (RPI Part #CVK501)
- Also available: Air Inlet Filter (RPI Part #CVF502) and Oxygen Inlet Filter (RPI Part #CVF503)

Fits: 9.4" GUI

Models: 840

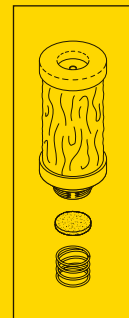

RPI Part #CVF503
OEM Part #4-072204-00

OXYGEN INLET FILTER

- 0.3 micron
- Size: .96" dia. x 1.91" lg.
- Included in: Ventilator PM Kit (10.4" GUI) (RPI Part #CVK500) and Ventilator PM Kit (with Lamps - 9.4" GUI) (RPI Part #CVK501)
- Also available: Air Inlet Filter (RPI Part #CVF502) and Lamp (RPI Part #CVL505)

Fits: Inspiratory Module

Models: 840



replacement parts industries, inc.

CALL (800) 221-9723 • FAX (818) 882-7028 • EMAIL order@riparts.com • WEBSITE www.riparts.com

The above parts are manufactured by Replacement Parts Industries, Inc. to fit the equipment noted. All product names used in this document are trademarks or registered trademarks of their respective holders. 2008CV SHOW 01/21

New PM Kits to fit Covidien/Puritan Bennett™ 840 Ventilators!

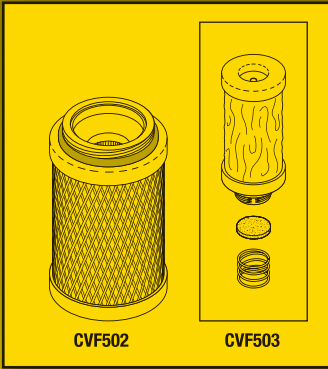

CVF502

CVF503

RPI Part #CVK500
 OEM Part #4-078179-00
 VENTILATOR PM KIT (10.4" GUI)

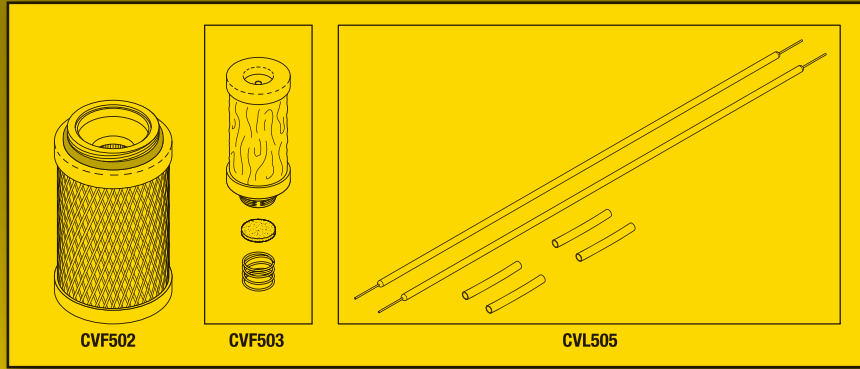

CVF502

CVF503

CVL505

RPI Part #CVK501
 OEM Part #4-079056-00
 VENTILATOR PM KIT (WITH LAMPS - 9.4" GUI)

New Line of Parts to fit Covidien/Puritan Bennett™ 840 Ventilators!

ADDRESS SERVICES REQUESTED

PERMIT NO. 2399
 VAN NUYS, CA
 U.S. POSTAGE PAID
 PRESORTED STANDARD

id!
 replacement parts industries, inc.
 625 Cochran Street • Simi Valley, California • 93065

New Parts to fit Covidien/Puritan Bennett™ 840 Ventilators!

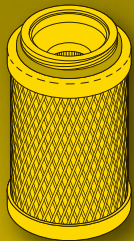

RPI Part #CVF502
 OEM Part #4-072203-00
 AIR INLET FILTER

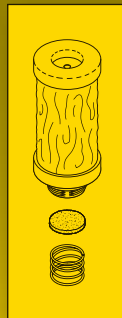

RPI Part #CVF503
 OEM Part #4-072204-00
 OXYGEN INLET FILTER

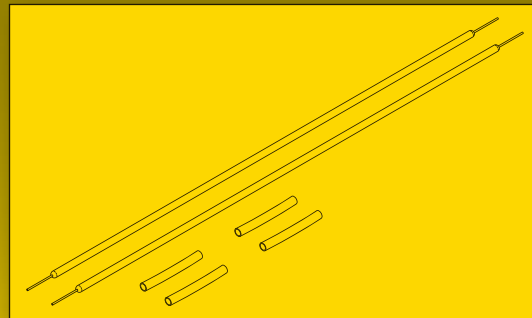

RPI Part #CVL505
 OEM Part # (OEM Part # Not Available)
 LAMP



Pricing Reduced on New Parts to fit Covidien/Puritan Bennett™ 840 Ventilators!

We made a big error in the pricing of our new line of parts to fit Covidien/Puritan Bennett™ 840 Ventilators!

Our pricing should have been lower, *much lower!*

Please accept our apology and note the new lower prices. And for our customers who have already purchased any of these parts, please note that a credit for the difference will be added to your account.

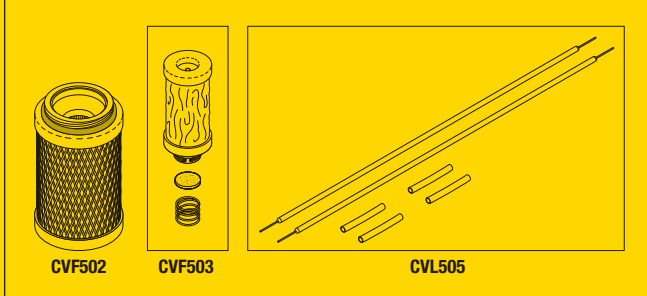

RPI Part #CVK501
OEM Part #4-079056-00

VENTILATOR PM KIT (WITH LAMPS - 9.4" GUI)

- 10,000 hour Planned Maintenance Kit
- Includes: Air Inlet Filter (RPI Part #CVF502), Oxygen Inlet Filter (RPI Part #CVF503), Lamp (RPI Part #CVL505), and PM Sticker

Models: 840

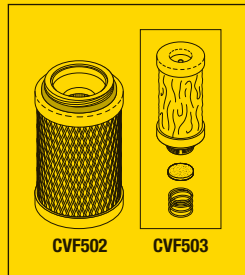

RPI Part #CVK500
OEM Part #4-078179-00

VENTILATOR PM KIT (10.4" GUI)

- 10,000 hour Planned Maintenance Kit
- Includes: Air Inlet Filter (RPI Part #CVF502), Oxygen Inlet Filter (RPI Part #CVF503), and PM Sticker

Models: 840



RPI Part #CVF502
OEM Part #4-072203-00

AIR INLET FILTER

- 0.3 micron
- Size: 1-3/4" dia. x 2-3/4" lg.
- Included in: Ventilator PM Kit (10.4" GUI) (RPI Part #CVK500) and Ventilator PM Kit (with Lamps - 9.4" GUI) (RPI Part #CVK501)
- Also available: Oxygen Inlet Filter (RPI Part #CVF503) and Lamp (RPI Part #CVL505)

Fits: Inspiratory Module
Models: 840



RPI Part #CVF503
OEM Part #4-072204-00

OXYGEN INLET FILTER

- 0.3 micron
- Size: .96" dia. x 1.91" lg.
- Included in: Ventilator PM Kit (10.4" GUI) (RPI Part #CVK500) and Ventilator PM Kit (with Lamps - 9.4" GUI) (RPI Part #CVK501)
- Also available: Air Inlet Filter (RPI Part #CVF502) and Lamp (RPI Part #CVL505)

Fits: Inspiratory Module
Models: 840

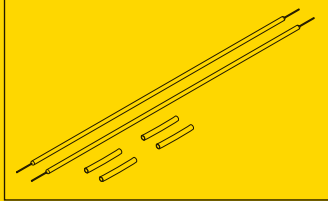

RPI Part #CVL505
OEM Part # (OEM Part # Not Available)

LAMP

- 2 per package
- Size: 2.6 mm (.102" dia.) x 214 mm (8.43" lg.) full spectrum CCFL
- Included in: Ventilator PM Kit (with Lamps - 9.4" GUI) (RPI Part #CVK501)
- Also available: Air Inlet Filter (RPI Part #CVF502) and Oxygen Inlet Filter (RPI Part #CVF503)

Fits: 9.4" GUI
Models: 840



replacement parts industries, inc.

CALL (800) 221-9723 • FAX (818) 882-7028 • EMAIL order@riparts.com • WEBSITE www.rpiparts.com

The above parts are manufactured by Replacement Parts Industries, Inc. to fit the equipment noted. All product names used in this document are trademarks or registered trademarks of their respective holders. 2008CV SHOW 06/21

COVIDIEN/PURITAN BENNETT

SECTION 5
 PAGE 700
 UPDATED 06/21



Pricing Reduced on New Parts to fit Covidien/Puritan Bennett™ 840 Ventilators!

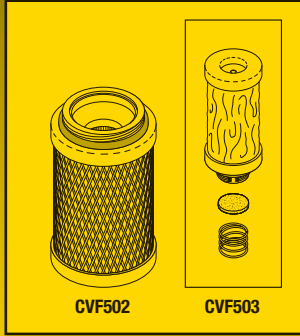

CVF502 CVF503

RPI Part #CVK500
OEM Part #4-078179-00
VENTILATOR PM KIT (10.4" GUI)

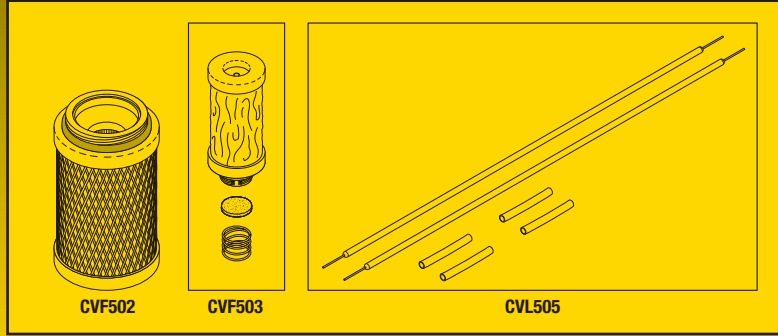

CVF502 CVF503 CVL505

RPI Part #CVK501
OEM Part #4-079056-00
VENTILATOR PM KIT (WITH LAMPS - 9.4" GUI)

Pricing Reduced on New Parts to fit Covidien/Puritan Bennett™ 840 Ventilators!

ADDRESS SERVICES REQUESTED

replacement parts industries, inc.
625 Cochran Street • Simi Valley, California • 93065



PRESENTED STANDARD
U.S. POSTAGE PAID
VAN NUYS, CA
PERMIT NO. 2399



Pricing Reduced on New Parts to fit Covidien/Puritan Bennett™ 840 Ventilators!

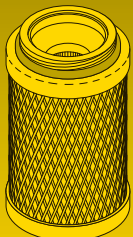

RPI Part #CVF502
OEM Part #4-072203-00
AIR INLET FILTER

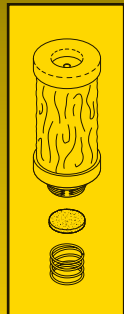

RPI Part #CVF503
OEM Part #4-072204-00
OXYGEN INLET FILTER

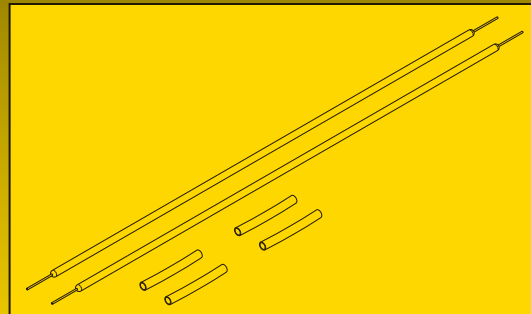

RPI Part #CVL505
OEM Part # (OEM Part # Not Available)
LAMP

GENERAL SHOP AIDS

ACCESSORIES & SUPPLIES

Adhesives	201
Compressor Oil	201
Grease	201
Hydraulic Fluid	201
Lubricants	201
Rotary Pump Oil	201
Storage Cases	200
Threadlocker	201

ELECTRICAL

Cable Ties	307
Cable Tie Accessories	307
Cable Tie Tool	307
Electrical Tape	308
Fuses and Fuse Puller	306
Heat Shrink Tubing	308
High Temperature Sleeving	308
High Temperature Terminals and Crimping Tool	309
High Temperature Wire	309
Hospital Grade Extension Cords	302
Hospital Grade Plugs and Connectors	304
Hospital Grade Power Cords	300-301
Industrial Grade Extension Cords	303
Industrial Grade Plugs and Connectors	304
Industrial Grade Power Cords	302-303
Outlet Module	300
Power Cord Accessories	303
Receptacles	303
Strain Relief Bushings and Strain Relief Pliers	305
Terminals and Crimp Tool	310

HARDWARE

Accessories	400
L-Hex Wrench Sets	400
Lockwasher Kit	402
Metric Screws	401
Phillips Pan Head Hardware Kit	402
Pozidrive® Screwdrivers	401
Socket Head Cap Screws	400
Socket Head Set Screws	400

O-RINGS

O-Ring Accessories	503
O-Ring Kits	503-504
O-Ring References	500-502
O-Ring Tools	503

PLUMBING

Accessories	600-601
Barbs	602
Compression Fittings	601
Copper Tubing	600
Metal Tubing Tools	600
Sleeve Tools	602

(continued)

GENERAL SHOP AIDS (continued)

TOOLS

Adjustment Tool (Spring Tension)	702
Balldrivers	701
Cable Tie Tool	700
Cam Tool	701
Fuse Puller	700
Gas Spring Tool	702
L-Hex Wrench Sets	700
Max Register Thermometer	701
Metal Tubing Snake and Accessories	703
Metal Tubing Tools	700
O-Ring Tools	702
Plastic Tubing Snake and Accessories	703
Pozidrive® Screwdrivers	701
Sleeve Tools	702
Socket Retractor Tool	702
Spanner Wrench and Nuts	701
Strain Relief Bushing Pliers	700
Terminal Crimp Tool	700
Test Pressure Gauge	701
Trim Pot Adjustment Tool	701
Valve Core Removal Syringe Tool	702
Valve Seat Tools	701

RPI Part #RPB560

6-COMPARTMENT STORAGE CASE

- 4" X 8" x 1-3/16"
- Material: Clear plastic

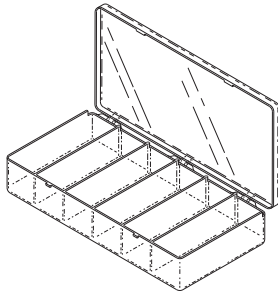

RPI Part #RPB414

8-COMPARTMENT STORAGE CASE

- 3" x 4-5/8" x 1-1/8"
- Material: Clear plastic

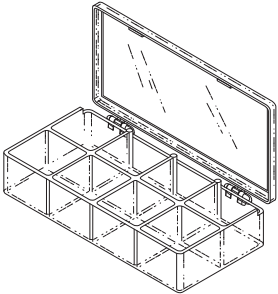

RPI Part #RPB416

12-COMPARTMENT STORAGE CASE

- 3-3/4" x 7" x 1-1/4"
- Material: Clear plastic

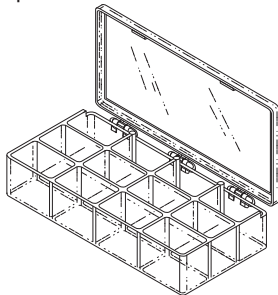

RPI Part #RPB415

12-COMPARTMENT STORAGE CASE

- 4-1/2" x 8-1/4" x 1-3/8"
- Material: Clear plastic

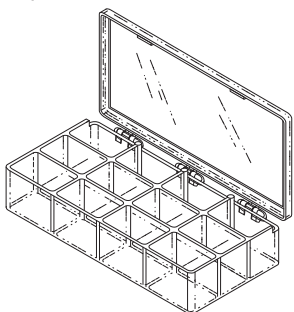

RPI Part #RPB417

18-COMPARTMENT STORAGE CASE

- 4" x 8" x 1-3/16"
- Material: Clear plastic

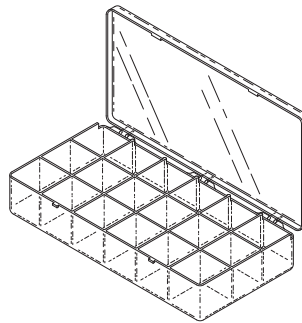

RPI Part #RPB419

18-COMPARTMENT STORAGE CASE

- 6-3/16" x 10-1/2" x 1-9/16"
- Material: Clear plastic

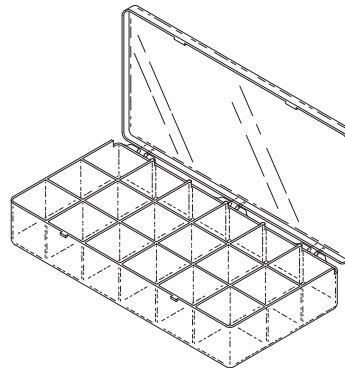

RPI Part #RPC476

CARRYING CASE

- Material: Black plastic case with foam inserts (*The "pick-n-pluck" foam inserts can be customized by you to create your own storage design and a blank case label is included for custom description to fit your needs.*)
- Inside dimensions: 13.25" x 7.38" x 3"
- Outside dimensions: 14" x 10.50" x 3.38"



RPI Part #RPC753

STORAGE CASE

- (3) standard compartments with (10) removable dividers allowing a maximum of 13 compartments
- Size: 12" x 4.5" x 1.5"
- Material: Translucent polypropylene

ADJUSTABLE AND REMOVABLE DIVIDER (x10)

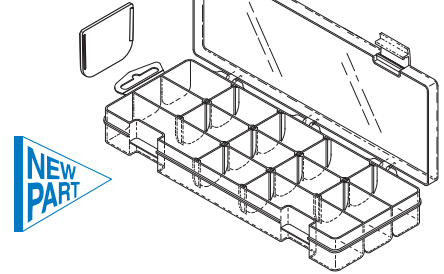

RPI Part #RPC751

STORAGE CASE

- (6) standard compartments with (28) removable dividers allowing a maximum of 34 compartments
- Size: 16.5" x 9.0" x 1.5"
- Material: Translucent polypropylene

ADJUSTABLE AND REMOVABLE DIVIDER (x28)

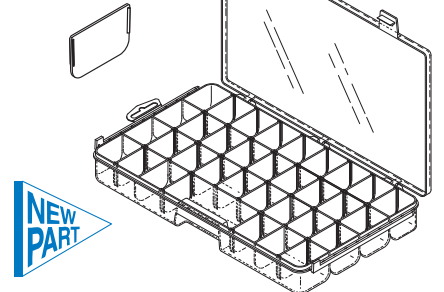

RPI Part #RPC616

STORAGE CASE

- (6) standard compartments (1-11/16" x 6-3/16") with (10) adjustable dividers
- 10-1/2" x 6-3/16" x 1-9/16"
- Material: Translucent polypropylene

ADJUSTABLE AND REMOVABLE DIVIDER (x10)

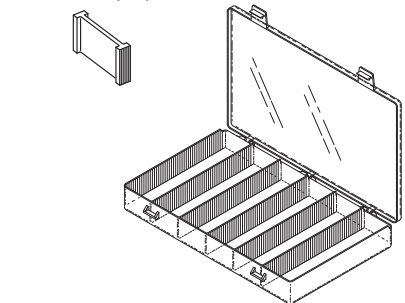

General Shop Aids

Accessories & Supplies (Adhesives, Compressor Oil, Grease, Hydraulic Fluid, Lubricants, Rotary Pump Oil, and Sealing Tape)

**RPI Part #RPA032
THREADLOCKER 242**

- 5 per package
- .02 fl. oz. per unit
- Prevents rust and corrosion
- Removable adhesive by Loctite®
- MSDS and Technical Data sheet available on RPI website



**RPI Part #RPA369
THREADLOCKER 545**

- 5 per package
- .02 fl. oz. per unit
- Temperature range of -65° to +300°F (-54° to +149°C)
- Seals operating pressures up to 10,000 PSI
- For use on all pneumatic and hydraulic fittings
- MSDS and Technical Data sheet available on RPI website



**RPI Part #RPL090
HIGH TEMP LUBRICANT**

- 5 per package
- 1/2 gram per unit
- For non-silicone use only
- Temperature range: -40° to +400°F (-40° to +204°C)
- MSDS and Technical Data sheet available on RPI website



**RPI Part #RPL615
O-RING LUBRICANT**

- 2 oz. tube
- Temperature Range: -65° to 400° F
- Can be used on Silicone and non-Silicone rubber materials
- Non-Toxic; Super-O-Lube® made by Parker
- MSDS and Technical Data sheet available on RPI website

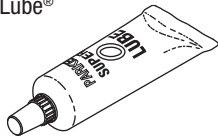

**RPI Part #RPC464
HEAT SINK COMPOUND**

- 5 per package
- .07 fl. oz. (2ml) per unit
- Non-silicone based thermal grease
- Does not dry out
- MSDS and Technical Data sheet available on RPI website



**RPI Part #RPL717
GREASE**

- 30cc package
- Renolit G 193 Grease
- Amber colored motor gear grease
- Temperature Range: 10° to 400°F
- MSDS and Technical Data sheet available on RPI website



**RPI Part #RPL680
BEARING GREASE**

- 5 per package
- 0.068 fl. oz. per unit
- Mobilith SHC100; Red synthetic grease
- Temperature Range: -65°F to 350°F (-54°C to 177°C)
- MSDS and Technical Data sheet available on RPI website



**RPI Part #RPS639
SILICONE GASKET MAKER 598**

- .5 fl. oz.
- Material: RTV black silicone
- Provides a sealant for pump tubing connections or can be used to seal power switch connections
- MSDS and Technical Data sheet available on RPI website

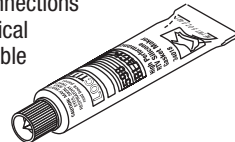

**RPI Part #RPA459
PIPE SEALANT 567**

- .20 fl. oz. (6ml)
- Temperature range: -65° to +400°F (-54° to +204°C)
- MSDS and Technical Data sheet available on RPI website

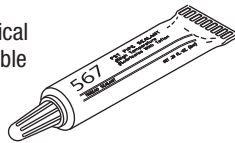

**RPI Part #RPT579
1/4" TEFLON THREAD SEALING TAPE**

- 5 per package
- 1/4" x 260" per unit

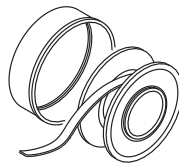

**RPI Part #RPT580
1/2" TEFLON THREAD SEALING TAPE**

- 5 per package
- 1/2" x 260" per unit



**RPI Part #CML001
COMPRESSOR OIL**

- 16 fl. oz.
- ISO100
- Non-detergent
- Includes dispensing tube and yorcker cap
- For use with most Copeland® head compressors
- Also available by the case of (12) 16 oz. bottles (RPI Part #CML045)
- MSDS and Technical Data sheet available on RPI website

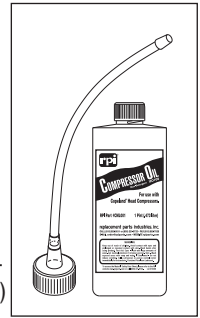

**RPI Part #RPF449
HYDRAULIC FLUID**

- 16 fl. oz.
- ISO46
- Includes yorcker spout
- For use with most dental chairs
- Also available by the case of (12) 16 oz. bottles (RPI Part #RPF453)
- MSDS and Technical Data sheet available on RPI website

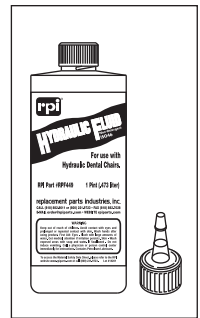

**RPI Part #RPF384
HYDRAULIC FLUID**

- 32 fl. oz.
- ISO22
- Additive-free 100N mineral oil
- Includes yorcker spout
- For use hydraulic exam tables that use additive free mineral oil
- MSDS and Technical Data sheet available on RPI website



**RPI Part #GOL022
ROTARY PUMP OIL**

- 4 fl. oz.
- ISO68
- Includes yorcker spout
- For use with Rotary Pumps (dispenses in oil reservoir)
- MSDS and Technical Data sheet available on RPI website

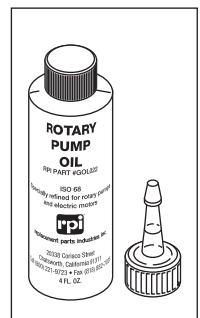

PowerMATE® - The only UL approved pole-mountable power tap for use in Patient Care areas!

RPI Part #RPP474

PowerMATE®

- Certified to UL Standard 1363A - for use in patient care areas.
- The 15 ft. power cord increases the mobility of the devices connected to the unit and helps eliminate extra power cord clutter.
- Three dual, hospital grade receptacles mounted in an angled surface allows for multiple AC adapters.
- Features a green power-on indicator on the surface of the unit.
- Unit and plugged in devices are protected by a 15-amp circuit breaker.
- The outlet module mounts on a pole (up to 1.5" in diameter), cart, or mobile flat surface. For indoor use only.
- Features a drip guard for mounting on an IV pole.

- A special nut on the thumbscrew can be tightened to lock the unit onto a pole, or an included locking screw cap can be used to secure the unit on a flat surface to prevent it from being easily moved.



Eliminate Cord Clutter – Mount unit on a pole or mobile flat surface!



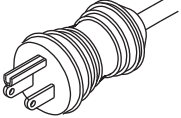
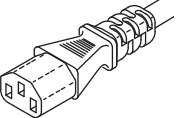
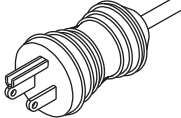
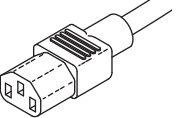
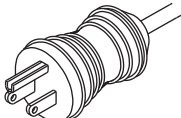
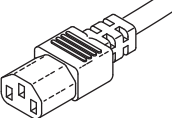
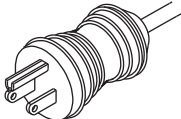
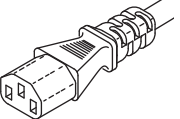
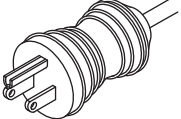
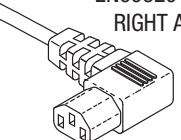

<p>POLE MOUNT</p> <p><i>Simply slide unit onto IV pole or the leg of a cart. Turn unit's thumbscrew to secure. Tighten locking hex nut.</i></p> 	<p>MOBILE FLAT SURFACE MOUNT</p> <p><i>Simply drill holes in mobile flat surface. Install mounting screws. Align unit's keyholes with mounting screws to secure. Install Hinged Screw Cover and snap it closed.</i></p> 
--	--

HOSPITAL GRADE	RPI PART #	LENGTH	DESCRIPTION	PLUG TYPE	CONNECTOR TYPE	COLOR / GRADE
	RPC260	10 ft.	HOSPITAL GRADE POWER CORD 14/3 SJT, 105°C 15A@125VAC	NEMA 5-15P 	EN60320-C13 	GRAY HOSPITAL GRADE
	RPC554	8 ft.	HOSPITAL GRADE POWER CORD 14/3 SJT, 105°C 15A@125VAC	NEMA 5-15P 	EN60320-C13 	GRAY HOSPITAL GRADE
	RPC555	18 ft.	HOSPITAL GRADE POWER CORD 14/3 SJT, 60°C 15A@125VAC	NEMA 5-15P 	EN60320-C13 	GRAY HOSPITAL GRADE
	RPC556	25 ft.	HOSPITAL GRADE POWER CORD 14/3 SJT, 105°C 15A@125VAC	NEMA 5-15P 	EN60320-C13 	GRAY HOSPITAL GRADE
	RPC770 RPC772 RPC774	8 ft. 18 ft. 25 ft.	HOSPITAL GRADE POWER CORD 14/3 SJT, 105°C 15A@125VAC	NEMA 5-15P 	EN60320-C13R RIGHT ANGLE 	GRAY HOSPITAL GRADE

More Hospital Grade Power Cords on next page →

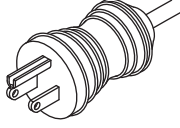
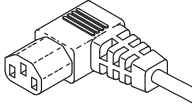
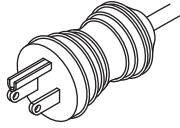
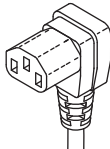
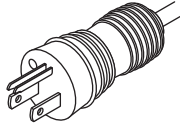
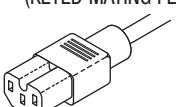
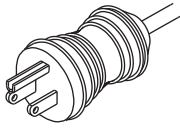
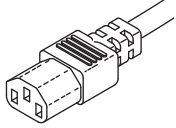
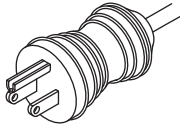
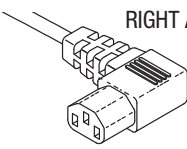
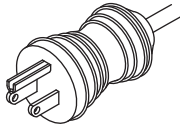
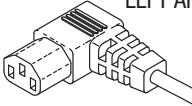
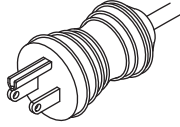
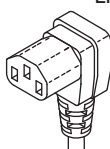
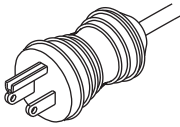
General Shop Aids

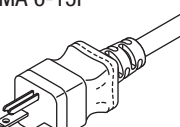
Electrical (Power Cords) - Continued

RPI PART #	LENGTH	DESCRIPTION	PLUG TYPE	CONNECTOR TYPE	COLOR / GRADE
RPC771 RPC773 RPC775	8 ft. 18 ft. 25 ft.	HOSPITAL GRADE POWER CORD 14/3 SJT, 105°C 15A@125VAC	NEMA 5-15P 	EN60320-C13L LEFT ANGLE 	GRAY HOSPITAL GRADE
RPC776	8 ft.	HOSPITAL GRADE POWER CORD 14/3 SJT, 105°C 15A@125VAC	NEMA 5-15P 	EN60320-C13D DOWN ANGLE 	GRAY HOSPITAL GRADE
CHC008	8 ft.	HOSPITAL GRADE POWER CORD 14/3 SJTOW, 105°C 15A@125VAC	NEMA 5-15P 	EN60320-C15 (KEYED MATING FEATURE) 	BLACK HOSPITAL GRADE
RPC868 RPC869 RPC557 RPC558 RPC559	1.5 ft. 3 ft. 8 ft. 18 ft. 25 ft.	HOSPITAL GRADE POWER CORD 16/3 SJT, 60°C 13A@125VAC	NEMA 5-15P 	EN60320-C13 	GRAY HOSPITAL GRADE
RPC778 RPC780 RPC782 RPC784 RPC786	1.5 ft. 3 ft. 8 ft. 18 ft. 25 ft.	HOSPITAL GRADE POWER CORD 16/3 SJT, 105°C 13A@125VAC	NEMA 5-15P 	EN60320-C13R RIGHT ANGLE 	GRAY HOSPITAL GRADE
RPC779 RPC781 RPC783 RPC785 RPC787	1.5 ft. 3 ft. 8 ft. 18 ft. 25 ft.	HOSPITAL GRADE POWER CORD 16/3 SJT, 105°C 13A@125VAC	NEMA 5-15P 	EN60320-C13L LEFT ANGLE 	GRAY HOSPITAL GRADE
RPC788	8 ft.	HOSPITAL GRADE POWER CORD 16/3 SJT, 105°C 13A@125VAC	NEMA 5-15P 	EN60320-C13D DOWN ANGLE 	GRAY HOSPITAL GRADE
RPC028	10 ft.	HOSPITAL GRADE POWER CORD 18/3 SJT, 60°C 10A@125VAC	NEMA 5-15P 	NONE  .320" OD CORD	GRAY HOSPITAL GRADE
RPC867	8 ft.	HOSPITAL GRADE POWER CORD 18/3 SJT, 60°C 10A@220VAC	NEMA 6-15P 	NONE  .307" OD CORD	GRAY HOSPITAL GRADE

HOSPITAL GRADE



Hospital Grade Extension Cords on next page →

HOSPITAL GRADE

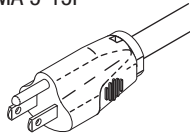
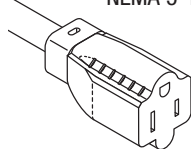
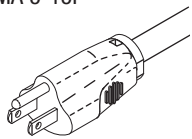
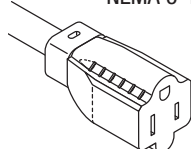
RPI PART #	LENGTH	DESCRIPTION	PLUG TYPE	CONNECTOR TYPE	COLOR / GRADE
RPC870 RPC871	8 ft. 12 ft.	HOSPITAL GRADE EXT CORD 16/3 SJT, 60°C 13A@125VAC	NEMA 5-15P 	NEMA 5-15R 	GRAY HOSPITAL GRADE
RPC872 RPC873	8 ft. 12 ft.	HOSPITAL GRADE EXT CORD 14/3 SJT, 60°C 15A@125VAC	NEMA 5-15P 	NEMA 5-15R 	GRAY HOSPITAL GRADE

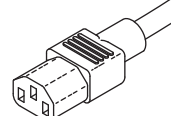
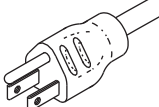
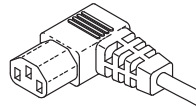
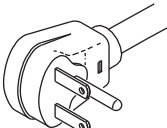
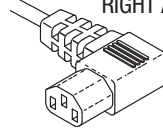
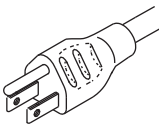
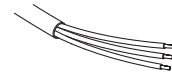
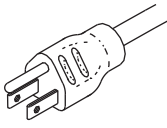
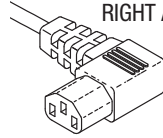
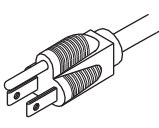
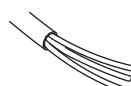
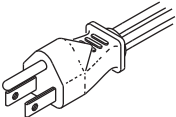
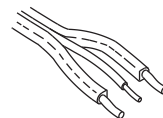

INDUSTRIAL GRADE

RPC262	10 ft.	POWER CORD 14/3 SJT, 60°C 15A@125VAC	NEMA 5-15P 	EN60320-C13 	BLACK INDUSTRIAL GRADE
RPC291	6 ft.	POWER CORD 14/3 SJT, 105°C 15A@125VAC	NEMA 5-15P 	EN60320-C13L LEFT ANGLE 	BLACK INDUSTRIAL GRADE
RPC582	12 ft.	POWER CORD 14/3 SJT, 105°C 15A@220VAC	NEMA 6-15P 	EN60320-C13R RIGHT ANGLE 	BLACK INDUSTRIAL GRADE
RPC880	9 ft.	POWER CORD 14/3 SJT, 105°C 15A@125VAC	NEMA 5-15P 	NONE  .378" OD CORD	BLACK INDUSTRIAL GRADE
TUC028	10 ft.	POWER CORD 14/3 SJT, 105°C 15A@125VAC	NEMA 5-15P 	EN60320-C13R RIGHT ANGLE 	BLACK INDUSTRIAL GRADE
PCC004	8 ft.	POWER CORD 16/3 HSJO, 105°C 13A@125VAC	NEMA 5-15P 	NONE  .350" OD CORD	BLACK INDUSTRIAL GRADE
RPC274	6 ft.	POWER CORD 16/3 SPT-2, 105°C 13A@125VAC	NEMA 5-15P 	NONE  .158" x .380" FLAT CORD	BLACK INDUSTRIAL GRADE

More Industrial Grade Power Cords on next page →

General Shop Aids

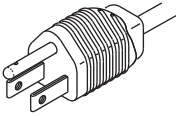
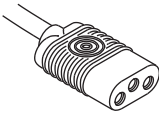
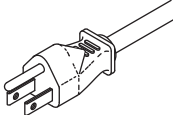
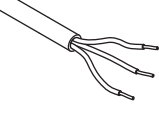
Electrical (Power Cords) - Continued

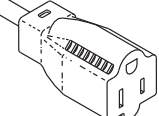
RPI PART #	LENGTH	DESCRIPTION	PLUG TYPE	CONNECTOR TYPE	COLOR / GRADE
BUC017	8 ft.	POWER CORD 18/3 SJT, 60°C 7A@125VAC	NEMA 5-15P 	BMI-3 	GRAY INDUSTRIAL GRADE
CAC015	8 ft.	POWER CORD 18/3 SJTW, 105°C 10A@125VAC	NEMA 5-15P 	NONE .328" OD CORD 	BLACK INDUSTRIAL GRADE
BUC018	8 ft.	EXT CORD 16/3 SJT, 60°C 13A@125VAC	NEMA 5-15P 	NEMA 5-15R 	BLACK INDUSTRIAL GRADE

Extension Cord

INDUSTRIAL GRADE

Electrical (Accessories & Receptacles)

ACCESSORIES

RPI Part #RPS672
CORD STRAP (WHITE 6")

- 3 per package
- 6" lg.
- White strap with white button
- Use to strap power cords

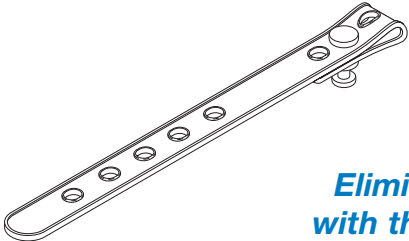

Eliminate power cord clutter with the adjustable Cord Strap!

RECEPTACLES

RPI Part #RPR290
SNAP-IN AC RECEPTACLE

- 15A@250VAC
- 1/4" quick connect tabs
- Fits panel cut-out: .787" x 1.083" (20mm x 27.5 mm); .060" (1.5mm) maximum panel Thk.

RPI Part #RPR583
AC INLET RECEPTACLE

- 15A@250VAC
- 1/4" quick connect tabs
- Fits panel cut-out: .787" x 1.083" (20mm x 27.5 mm); .134" dia. (3.4mm) @ 1.575" (40mm)

RPI Part #HBM011
POWER MODULE

- 15A@250VAC
- 1/4" quick connect tabs
- Fits panel cut-out: .787" x 1.083" (20mm x 27.5 mm); .079" (2mm) maximum panel Thk.

RPI Part #GEM015
POWER INPUT MODULE

- Includes installed fuse holders and (2 pcs) 1/2A@250VAC Fuse (RPI Part #RPF043)
- 1/8" quick connect tabs
- Fits panel cut-out: 1.220" x 2.205"

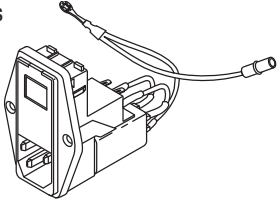

RPI Part #RPR710
AC INLET RECEPTACLE

- 15A@125VAC
- 1/4" quick connect tabs
- Keyed mating feature
- Includes: Mounting hardware
- Fits panel cut-out: .787" x 1.083"

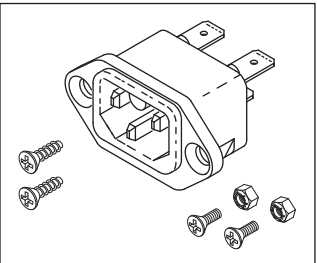

Hubbell® Brand Plugs and Connectors or Alternate Products - It's Your Choice!

The choice is yours. RPI is pleased to provide you with an option for your plug and connector requirements by offering top-of-the-line Hubbell products, as well as a quality, lower cost alternative for each plug and connector configuration. The alternate products that we offer are manufactured by reputable companies such as Woodhead and Marinco®. It's the RPI Advantage!

Please note: Illustrations show Hubbell part, alternate product may vary slightly in attributes and appearance.

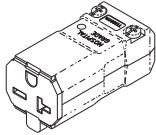
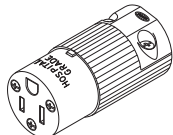
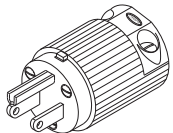
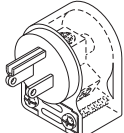
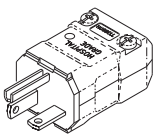
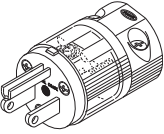
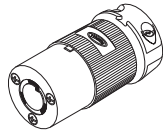
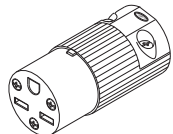
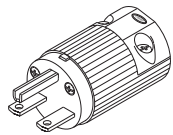
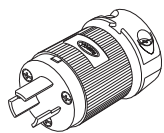
	RPI PART # (MADE BY HUBBELL)	RPI PART # (ALTERNATE PRODUCT)	PLUG/CONNECTOR TYPE
HOSPITAL GRADE	RPC585	RPC591	HOSPITAL GRADE FEMALE CONNECTOR <ul style="list-style-type: none"> • 20A@250VAC • Accepts .300" dia. to .660" dia. cord • NEMA 6-20R 
	RPC599	RPC031	HOSPITAL GRADE FEMALE CONNECTOR <ul style="list-style-type: none"> • 15A@125VAC • Accepts .325" dia. to .720" dia. cord • NEMA 5-15R 
	RPP029	RPP596	HOSPITAL GRADE MALE PLUG <ul style="list-style-type: none"> • 15A@125VAC • Accepts .230" dia. to .720" dia. cord • NEMA 5-15P 
	RPP032	RPP597	HOSPITAL GRADE MALE PLUG (RIGHT ANGLE) <ul style="list-style-type: none"> • 15A@125VAC • Accepts .255" dia. to .665" dia. cord • NEMA 5-15P • Transparent housing 
	RPP584	RPP590	HOSPITAL GRADE MALE PLUG <ul style="list-style-type: none"> • 20A@250VAC • Accepts .300" dia. to .660" dia. cord • NEMA 6-20P 
	RPP598	RPP030	HOSPITAL GRADE MALE PLUG <ul style="list-style-type: none"> • 15A@125VAC • Accepts .230" dia. to .720" dia. cord • NEMA 5-15P • Transparent housing 
INDUSTRIAL GRADE	RPC587	RPC593	FEMALE CONNECTOR (LOCKING) <ul style="list-style-type: none"> • 20A@250VAC • Accepts .360" dia. to .930" dia. cord • NEMA L6-20R 
	RPC589	RPC595	FEMALE CONNECTOR <ul style="list-style-type: none"> • 15A@250VAC • Accepts .230" dia. to .720" dia. cord • NEMA 6-15R 
	RPP588	RPP594	MALE PLUG <ul style="list-style-type: none"> • 15A@250VAC • Accepts .230" dia. to .720" dia. cord • NEMA 6-15P 
	RPP586	RPP592	MALE PLUG (LOCKING) <ul style="list-style-type: none"> • 20A@250VAC • Accepts .360" dia. to .930" dia. cord • NEMA L6-20P 

General Shop Aids

Electrical (Strain Relief Bushings, and Strain Relief Bushing Pliers)

RPI Part #RPT172

STRAIN RELIEF BUSHING PLIERS

- Hand pliers adjustable for all bushings that assemble into mounting hole up to 7/8" diameter
- ~7" lg.

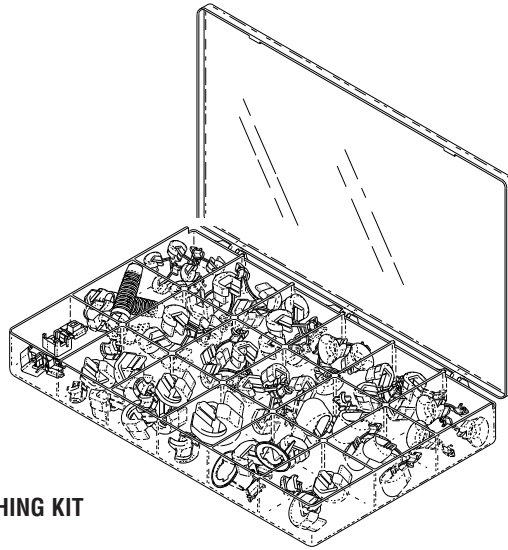
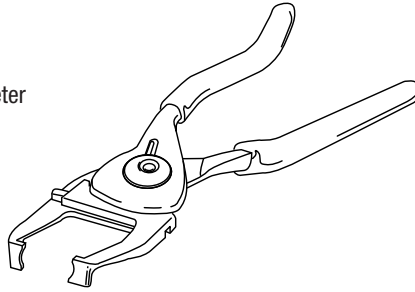

**RPK412
STRAIN RELIEF BUSHING KIT**

RPI Part #RPK412

STRAIN RELIEF BUSHING KIT

- Kit includes 18-compartment storage case (RPI Part #RPB419)
- Strain relief bushings are also sold separately in quantities indicated below

RPI PART #	TYPE	CORD TYPE	CORD OD RANGE	MOUNTING HOLE	QTY
RPB154	SR-3P-4	FLAT CABLE	.120" x .220"	7/16"	20
RPB155	SR-5N-7	ROUND CABLE	.250" - .290"	1/2"	5
RPB156	ST-100N	FLAT CABLE	.120" - .160" x .220" - .300"	1/2"	10
RPB157	SR-4K-6	FLAT CABLE	.120" - .150" x .280" - .300"	1/2"	10
RPB158	SR-5K-4	FLAT CABLE	.150" - .200" x .350" - .410"	9/16"	10
RPB159	SR-7P-2	ROUND CABLE	.360" - .430"	3/4"	6
RPB160	SR-4N-4	FLAT CABLE	.120" - .150" x .280" - .300"	1/2"	15
RPB161	SR-6W-1	ROUND CABLE	.300"	1/2"	15
RPB162	SR-8P-2	ROUND CABLE	.530" - .600"	7/8"	4
RPB163	SR-4N-5	FLAT CABLE	.120" - .160" x .280" - .300"	1/2"	8
RPB164	SR-6N3-4	ROUND CABLE	.325" - .360"	5/8"	8
RPB165	SR-9P-2	ROUND CABLE	.600" - .690"	1"	1
RPB166	SR-5P-4	ROUND CABLE	.250" - .290"	1/2"	15
RPB167	SR-11-2	ROUND CABLE	.325" - .355"	5/8"	6
RPB168	SR-30-1	FLAT CABLE	.150" - .200" x .350" - .430"	9/16"	5
RPB169	SR-5N-5	ROUND CABLE	.250" - .290"	1/2"	8
RPB170	SR-14-1	FLAT CABLE	.120" - .160" x .280" - .300"	1/2"	10
RPB171	SR-34-2	FLAT CABLE	.240" - .290" x .420" - .650"	7/8"	4

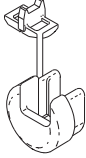
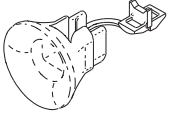
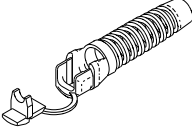
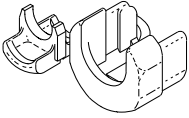
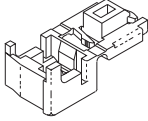
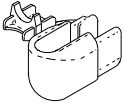
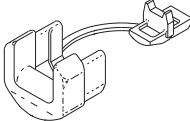
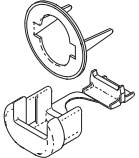
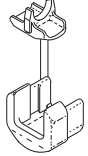
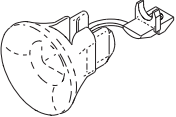
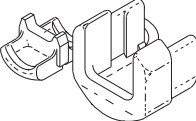
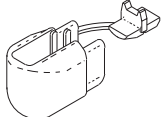
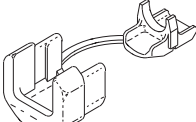
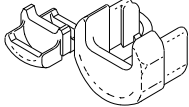
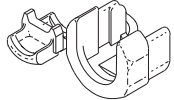
 RPB154 & RPB160	 RPB163
 RPB155	 RPB165
 RPB156	 RPB167
 RPB157	1/2" KNOCK-OUT ADP  RPB168
 RPB158, RPB164 & RPB166	 RPB169
 RPB159	 RPB170
 RPB161	 RPB171
 RPB162	<p>Visit the RPI website www.rpiparts.com</p>

RPI Part #RPT502

FUSE PULLER

- ~2" lg.
- Yellow Polycarbonate
- Non-slip handle
- Removes or installs glass, ceramic or blade style fuses
- Ideal for tight spaces

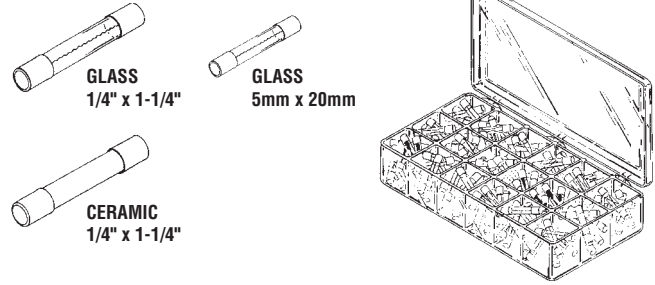
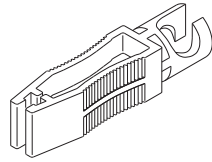

RPI PART #RPK410

FUSE KIT (1/4" x 1-1/4" FAST ACTING)

- Kit includes 18-compartment storage case (RPI Part #RPB417)
- Fuses are also sold separately in quantities indicated below

RPI PART #	AMPS	VOLTS	TYPE	QTY
RPF041	1/8A	250V	GLASS	5
RPF042	1/4A	250V	GLASS	5
RPF043	1/2A	250V	GLASS	5
RPF044	3/4A	250V	GLASS	5
RPF045	1A	250V	GLASS	5
RPF073	1-1/4A	250V	GLASS	5
RPF046	1-1/2A	250V	GLASS	5
RPF047	2A	250V	GLASS	5
RPF048	2-1/2A	250V	GLASS	5
RPF049	3A	250V	GLASS	5
RPF050	4A	250V	GLASS	5
RPF051	5A	250V	GLASS	5
RPF052	6A	250V	GLASS	5
RPF053	8A	250V	GLASS	5
RPF054	10A	250V	GLASS	5
RPF055	15A	32V	GLASS	5
RPF056	25A	32V	GLASS	5
RPF057	30A	32V	GLASS	5

RPI PART #RPK520

FUSE KIT (5mm x 20mm FAST ACTING)

- Kit includes 18-compartment storage case (RPI Part #RPB417)
- Fuses are also sold separately in quantities indicated below

RPI PART #	AMPS	VOLTS	TYPE	QTY
RPF503	1/32A	250V	GLASS	5
RPF504	1/20A	250V	GLASS	5
RPF505	1/10A	250V	GLASS	5
RPF506	1/8A	250V	GLASS	5
RPF507	1/5A	250V	GLASS	5
RPF508	1/4A	250V	GLASS	5
RPF509	2/5A	250V	GLASS	5
RPF510	1/2A	250V	GLASS	5
RPF511	4/5A	250V	GLASS	5
RPF512	1A	250V	GLASS	5
RPF513	1-1/4A	250V	GLASS	5
RPF367	2A	250V	GLASS	5
RPF514	2-1/2A	250V	GLASS	5
RPF515	4A	250V	GLASS	5
RPF516	5A	250V	GLASS	5
RPF517	8A	250V	GLASS	5
RPF518	10A	250V	GLASS	5
RPF519	15A	250V	GLASS	5

RPI PART #RPK411

FUSE KIT (1/4" x 1-1/4" TIME DELAY)

- Kit includes 18-compartment storage case (RPI Part #RPB417)
- Fuses are also sold separately in quantities indicated below

RPI PART #	AMPS	VOLTS	TYPE	QTY
RPF058	1/10A	250V	GLASS	5
RPF059	1/4A	250V	GLASS	5
RPF060	1/2A	250V	GLASS	5
RPF061	1A	250V	GLASS	5
RPF062	1-1/2A	250V	GLASS	5
RPF063	2A	250V	GLASS	5
RPF064	2-1/2A	250V	GLASS	5
RPF065	3A	250V	GLASS	5
RPF066	4A	250V	GLASS	5
RPF067	5A	250V	GLASS	5
RPF068	6-1/4A	250V	GLASS	5
RPF069	15A	32V	GLASS	5
RPF551	6A	250V	CERAMIC	5
RPF552	8A	250V	CERAMIC	5
RPF553	10A	250V	CERAMIC	5
RPF070	12A	250V	CERAMIC	5
RPF071	15A	250V	CERAMIC	5
RPF072	20A	250V	CERAMIC	5

RPI PART #RPK538

FUSE KIT (5mm x 20mm TIME DELAY)

- Kit includes 18-compartment storage case (RPI Part #RPB417)
- Fuses are also sold separately in quantities indicated below

RPI PART #	AMPS	VOLTS	TYPE	QTY
RPF521	1/32A	250V	GLASS	5
RPF522	1/20A	250V	GLASS	5
RPF523	1/10A	250V	GLASS	5
RPF524	1/8A	250V	GLASS	5
RPF525	1/5A	250V	GLASS	5
RPF368	1/4A	250V	GLASS	5
RPF526	2/5A	250V	GLASS	5
RPF527	1/2A	250V	GLASS	5
RPF528	4/5A	250V	GLASS	5
RPF529	1A	250V	GLASS	5
RPF530	1-1/4A	250V	GLASS	5
RPF531	2A	250V	GLASS	5
RPF532	2-1/2A	250V	GLASS	5
RPF533	4A	250V	GLASS	5
RPF534	5A	250V	GLASS	5
RPF535	8A	250V	GLASS	5
RPF536	10A	250V	GLASS	5
RPF537	15A	250V	GLASS	5

General Shop Aids

Electrical (Cable Ties, Cable Tie Tool, and Accessories)

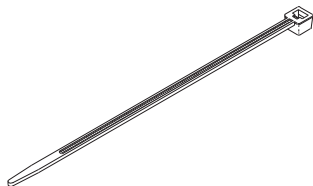

RPI Part #RPT085
CABLE TIE (8" BLACK)
 • 25 per package
 • 3/16" x 8" lg.

RPI Part #RPT375
CABLE TIE (12" BLACK)
 • 25 per package
 • 3/16" x 12" lg.



RPI Part #RPT396
CABLE TIE (4" GRAY)
 • 25 per package
 • .098" x 4" lg.

RPI Part #RPT397
CABLE TIE (8" GRAY)
 • 25 per package
 • .098" x 8" lg.

RPI Part #RPT398
CABLE TIE (12" GRAY)
 • 25 per package
 • .145" x 12" lg.

RPI Part #RPT083
CABLE TIE (4" WHITE)
 • 25 per package
 • 1/8" x 4" lg.

RPI Part #RPT661
CABLE TIE (6" WHITE)
 • 25 per package
 • 1/8" x 6" lg.



RPI Part #RPT084
CABLE TIE (8" WHITE)
 • 25 per package
 • 3/16" x 8" lg.

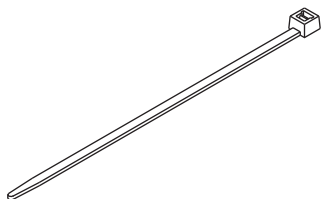

RPI Part #RPT480
CABLE TIE - HIGH TEMP (4" AQUA BLUE)
 • 25 per package
 • 1/8" x 4" lg.
 • Material: Tefzel®
 • Max. temperature rating: 338°F (170°C)
 • Resistant to most chemicals

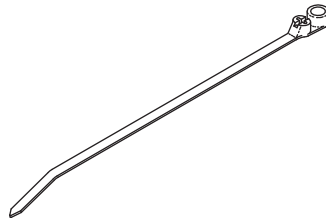

RPI Part #RPT278
CABLE TIE (8" WHITE)
 • 25 per package
 • 3/16" x 8" lg.
 • With #10 mounting hole

RPI Part #RPT279
CABLE TIE (8" BLACK)
 • 25 per package
 • 3/16" x 8" lg.
 • With #10 mounting hole

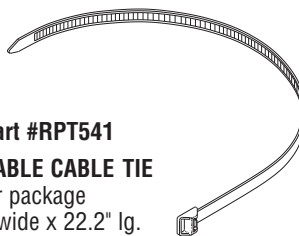

RPI Part #RPT541
REUSABLE CABLE TIE
 • 5 per package
 • .50" wide x 22.2" lg.
 • Color: black
 • Material: Weather resistant Nylon®
 • Extra heavy duty
 • Maximum size of bundle is 6.0"
 • Releasable strap for quick removal
 • Reusable strap
 • Can be used to mount Midwest fiber optic light source (OEM Part #491043R)

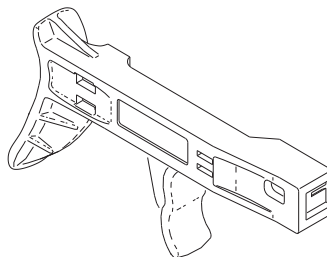

RPI Part #RPT477
CABLE TIE TOOL
 • ~6-1/2" lg.
 • Material: Plastic
 • Use this tool for applying a wide variety of ties making for fast application and a clean cut-off
 • A lightweight pocket sized tool
 • .094" to .184" tie width
 • Made by Thomas & Betts



RPI Part #RPM542
CABLE TIE MOUNT (4-WAY)
 • 10 per package
 • 1" x 1"
 • Material: Natural Nylon®
 • Adhesive backed mount
 • .190" dia. countersunk mounting hole
 • Allows up to .22" wide cable ties

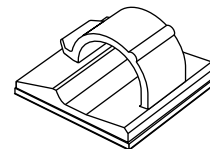

RPI Part #ADC058
CORD CLIP
 • 10 per package
 • 3/8" wire capacity
 • Material: Natural Nylon®
 • Adhesive backing
 • Meets UL94V-2 Flame Class

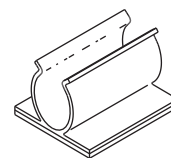

RPI Part #RPC543
SNAP-IN CORD CLIP
 • 10 per package
 • 1" x 1" with a 1/2" dia. holding capacity
 • Material: PVC
 • Color: gray
 • Adhesive backed mount

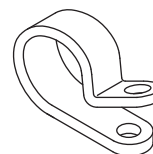

RPI Part #RPC701
CABLE CLAMP
 • 5 per package
 • For 1/4" OD bundle
 • Material: Nylon®
 • #8 mounting hole

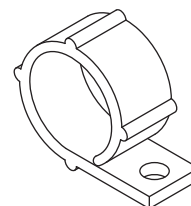

RPI Part #RPC702
CABLE HOLDER
 • 5 per package
 • 3/8" ID
 • Material: Nylon®
 • #10 mounting hole
 • Flexible loop for ease of installing and removing tubing

RPI Part #RPK499

HEAT SHRINK TUBING KIT

- 75 pieces of various sizes per Kit
- Each tube ~4" lg.
- Shrink temperature: 158°F (70°C)
- Shrinks to 50% original size
- Color of tubing: Black
- Kit includes 6-compartment storage case (RPI Part #RPB560)
- Tubing is also sold separately in quantities indicated below

RPI PART #	STARTING OD	FINISHED OD	QTY
RPT573	1/8"	1/16"	30
RPT574	3/16"	3/32"	20
RPT575	1/4"	1/8"	10
RPT576	3/8"	3/16"	5
RPT577	1/2"	1/4"	5
RPT578	3/4"	3/8"	5

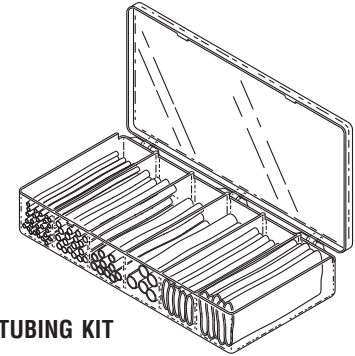

RPK499
HEAT SHRINK TUBING KIT

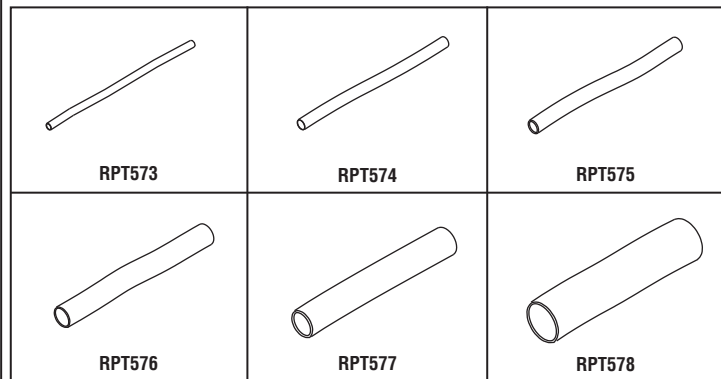

RPI Part #RPS381

HI-TEMP SLEEVING

- Sold by the foot (Reel NOT included)
- 5/32" nom. ID expands to 3/16" max ID
- Silicone rubber coated fiberglass sleeving
- Color: tan
- Temperature rating -67°F to +392°F (-55°C to +200°C)
- High current protection
- Flexible
- Great for protecting non-insulated terminals, butt connectors and all in-line connections

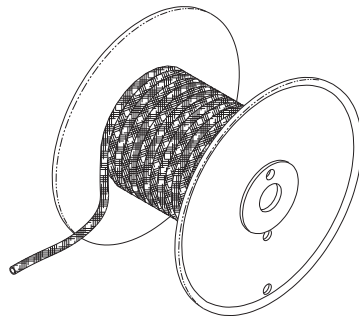

RPI Part #RPS399

HI-TEMP SLEEVING

- Sold by the foot (Reel NOT included)
- 1/4" nom. ID expands to 3/8" max ID
- Silicone rubber coated fiberglass sleeving
- Color: tan
- Temperature rating -67°F to +392°F (-55°C to +200°C)
- High current protection
- Flexible
- Great for protecting non-insulated terminals, butt connectors and all in-line connections

RPI Part #RPT500

ELECTRICAL TAPE

- 3/4" x 66'
- Material: Black vinyl
- 600V dielectric, 220°F (105°C) max temperature
- Waterproof
- UL Listed
- 3M Scotch Super 33+
- Dispenser pack with built-in tape cutter

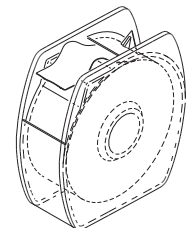

Visit the RPI website
www.rpiparts.com

General Shop Aids

Electrical (High Temperature Terminals, High Temperature Wire, and Crimping Tool)

RPI Part #RPT482

TERMINAL CRIMP TOOL

- ~ 8-1/4" lg.
- Steel with cushion grip handles
- Wire stripper - AWG #10 to #22
- Crimps #10 to #22 insulated and non-insulated terminals
- Cuts #4-40 to #10-32 screws
- Hardened pivot joint bushing for long life
- Includes pliers at tip, wire loop former and wire cutter
- Made by Blue Point® for Snap-on®

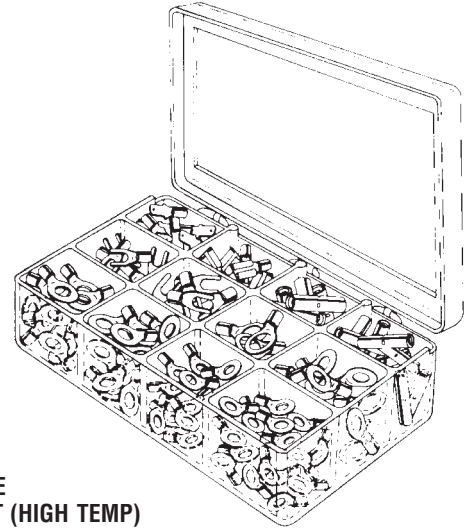
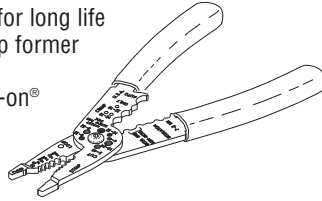



**RPK406
CRIMP-ON WIRE
CONNECTOR KIT (HIGH TEMP)**

RPI PART #RPK406

CRIMP-ON WIRE CONNECTOR KIT (HIGH TEMP)

- Kit includes 12-compartment storage case (RPI Part #RPB416)
- Terminals are also sold separately in quantities indicated below

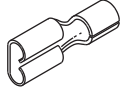
RPI PART #	SIZE	AWG RANGE	QTY
RPT019	#8 RING TERMINAL	#16-14 AWG	20
RPT020	#10 RING TERMINAL	#16-14 AWG	20
RPT021	#8 RING TERMINAL	#12-10 AWG	20
RPT022	#10 RING TERMINAL	#12-10 AWG	20
RPT023	1/4" RING TERMINAL	#12-10 AWG	20
RPT024	5/16" RING TERMINAL	#12-10 AWG	10
RPT025	#10 SPADE TERMINAL	#16-14 AWG	20
RPT026	#10 SPADE TERMINAL	#12-10 AWG	20
RPT027	BUTT CONNECTOR	#16-14 AWG	20
RPT028	BUTT CONNECTOR	#12-10 AWG	20
RPT029	QUICK DISCONNECT .250" FEMALE TAB	#16-14 AWG	20
RPT030	QUICK DISCONNECT .250" MALE TAB	#16-14 AWG	20

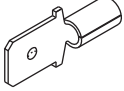
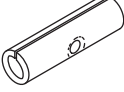
 RING TERMINAL	 QUICK DISCONNECT .250" FEMALE TAB
 SPADE TERMINAL	 QUICK DISCONNECT .250" MALE TAB
 BUTT CONNECTOR	<p>Visit the RPI website www.rpiparts.com</p>

Wire (High Temperature)

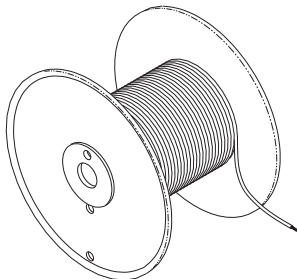

HIGH TEMPERATURE WIRE

- Sold by the foot (Reel NOT included)
- Teflon® insulated
- Type EE, 1000V
- Max. operating temperature: 392°F (200°C)

RPI PART #	AWG	COLOR
RPW034	#14 AWG	YELLOW
RPW076	#14 AWG	RED
RPW077	#14 AWG	BLACK
RPW086	#14 AWG	WHITE
RPW033	#16 AWG	WHITE
RPW078	#20 AWG	BLUE
RPW079	#20 AWG	VIOLET
RPW080	#20 AWG	RED
RPW081	#20 AWG	BLACK
RPW082	#20 AWG	ORANGE

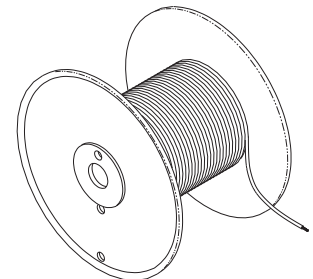

RPI Part #RPW382

HOOK UP WIRE

- Sold by the foot (Reel NOT included)
- #14 AWG
- Voltage rating: 600V
- Color: black
- Insulation: Chemically cross-linked Polyolefin
- Non-Teflon
- Max. operating temperature: 257°F (125°C)

RPI Part #RPT482

TERMINAL CRIMP TOOL

- ~8-1/4" lg.
- Steel with cushion grip handles
- Wire stripper - AWG #10 to #22
- Crimps #10 to #22 insulated and non-insulated terminals
- Cuts #4-40 to #10-32 screws
- Hardened pivot joint bushing for long life
- Includes pliers at tip, wire loop former and wire cutter
- Made by Blue Point® for Snap-on®

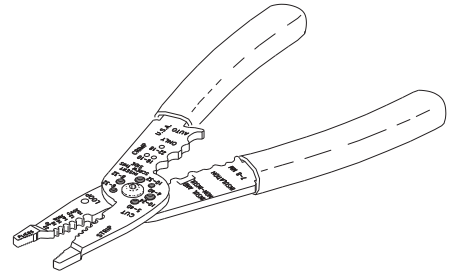

RPK401 CRIMP-ON WIRE CONNECTOR & WIRE NUT KIT

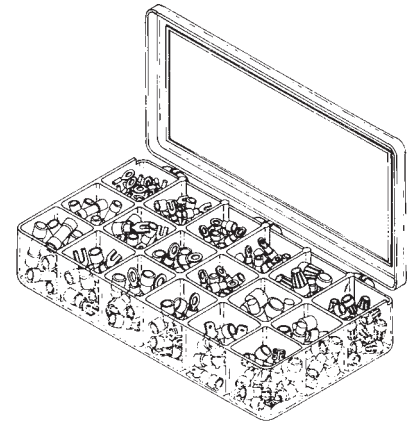

RPI PART #RPK401

CRIMP-ON WIRE CONNECTOR & WIRE NUT KIT

- Kit includes 18-compartment storage case (RPI Part #RPB417)
- Terminals are also sold separately in quantities indicated below

RPI PART #	SIZE	AWG RANGE	STYLE	QTY
RPT001	#6 RING TERMINAL	#22-18 AWG	NON-INSULATED	20
RPT002	#4 RING TERMINAL	#22-18 AWG	INSULATED (RED)	20
RPT003	#6 RING TERMINAL	#22-18 AWG	INSULATED (RED)	20
RPT004	#8 RING TERMINAL	#22-16 AWG	INSULATED (RED)	20
RPT005	#6 RING TERMINAL	#16-14 AWG	INSULATED (BLUE)	20
RPT006	#8 RING TERMINAL	#16-14 AWG	INSULATED (BLUE)	20
RPT007	#10 RING TERMINAL	#16-14 AWG	INSULATED (BLUE)	20
RPT008	#6 SPADE TERMINAL	#16-14 AWG	INSULATED (BLUE)	20
RPT009	#8 SPADE TERMINAL	#16-14 AWG	INSULATED (BLUE)	20
RPT010	#10 SPADE TERMINAL	#16-14 AWG	INSULATED (BLUE)	20
RPT011	BUTT CONNECTOR	#22-18 AWG	INSULATED (RED)	20
RPT012	BUTT CONNECTOR	#16-14 AWG	INSULATED (BLUE)	20
RPT013	PIG TAIL	#16-14 AWG	INSULATED (CLEAR)	20
RPT014	PIG TAIL	#12-10 AWG	INSULATED (CLEAR)	10
RPT015	QUICK DISCONNECT .250" FEMALE TAB	#16-14 AWG	INSULATED (BLUE)	20
RPT016	QUICK DISCONNECT .250" MALE TAB	#16-14 AWG	INSULATED (BLUE)	20
RPT017	WIRE NUT	#22-16 AWG	INSULATED (GREY)	15
RPT018	WIRE NUT	#18-12 AWG	INSULATED (YELLOW)	5

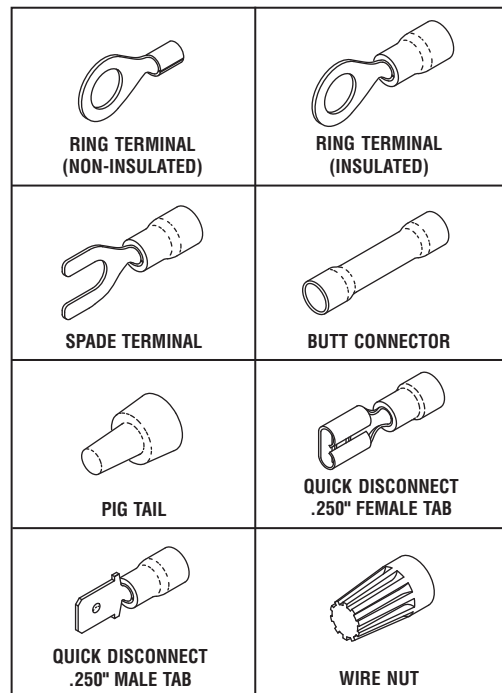

For high temperature wire connector kit and wire, see previous page.

RPI Part #RPT539

L-HEX WRENCH SET (METRIC)

- 9 piece set
- 1.5 mm through 10 mm
- Corrosion protected steel
- Made by Bondhus®

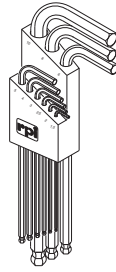

RPI Part #RPT540

L-HEX WRENCH SET (INCH)

- 13 piece set
- .050" through 3/8"
- Corrosion protected steel
- Made by Bondhus®

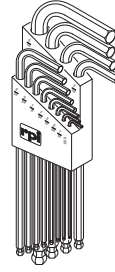

RPI Part #RPA032

THREADLOCKER 242

- 5 per package
- .02 fl. oz. per unit
- Prevents rust and corrosion
- Removable adhesive by Loctite®
- MSDS and Technical Data sheet available on RPI website

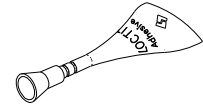

RPI PART #ADK110

SOCKET HEAD CAP SCREW KIT

- Kit includes 12-compartment storage case (RPI Part #RPB416)
- Stainless steel
- Hardware is also sold separately in quantities indicated below

RPI PART #	SIZE	QTY
ADS053	#6-32 x 1/4" lg.	25
ADS111	#6-32 x 3/8" lg.	25
ADS112	#6-32 x 1/2" lg.	25
ADS113	#6-32 x 5/8" lg.	25
ADS114	#6-32 x 7/8" lg.	25
ADS115	#6-32 x 1" lg.	25
ADS116	#4-40 x 1/4" lg.	25
ADS117	#4-40 x 3/8" lg.	25
ADS118	#4-40 x 1/2" lg.	25
ADS119	#4-40 x 3/4" lg.	25
ADS120	#2-56 x 1/2" lg.	25
ADS121	#1/4-20 x 5/8" lg.	15

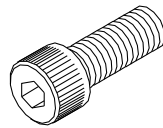

SOCKET HEAD CAP SCREW

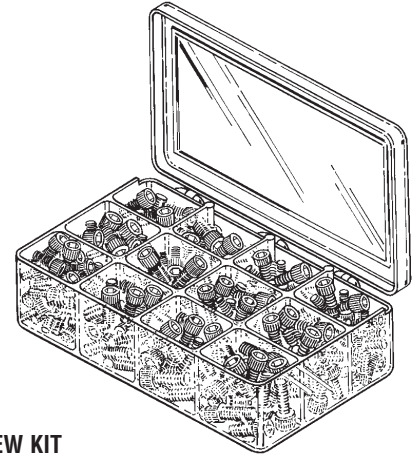

ADK110
SOCKET HEAD CAP SCREW KIT

RPI PART #RPK418

SOCKET SET SCREW KIT

- Kit includes 18-compartment storage case (RPI Part #RPB417)
- Heat treated alloy steel have black finish
- Cup point
- Hardware is also sold separately in quantities indicated below

RPI PART #	SIZE	QTY
RPH191	#4-40 x 1/8" lg.	50
RPH192	#4-40 x 3/16" lg.	50
RPH193	#4-40 x 1/4" lg.	50
RPH194	#6-32 x 1/8" lg.	50
RPH195	#6-32 x 3/16" lg.	50
RPH196	#6-32 x 1/4" lg.	50
RPH197	#6-32 x 5/16" lg.	50
RPH198	#6-32 x 3/8" lg.	50
RPH199	#8-32 x 1/8" lg.	50
RPH200	#8-32 x 3/16" lg.	50
RPH201	#8-32 x 1/4" lg.	50
RPH202	#8-32 x 5/16" lg.	50
RPH203	#8-32 x 3/8" lg.	50
RPH204	#10-32 x 3/16" lg.	50
RPH205	#10-32 x 1/4" lg.	50
RPH206	#10-32 x 5/16" lg.	50
RPH207	#10-32 x 3/8" lg.	50
RPH208	#10-32 x 1/2" lg.	50

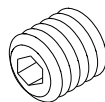

SOCKET SET SCREW CUP POINT

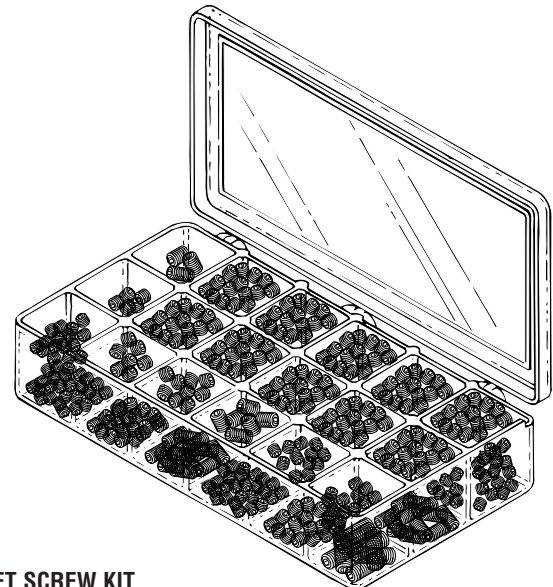

RPK418
SOCKET SET SCREW KIT

General Shop Aids

Hardware (Metric Screws, and Pozidrive® Screwdrivers)

RPT151

POZIDRIVE® SCREWDRIVER #1

- ~6-1/2" lg.
- For use with the Pozidrive Screw Kit (RPI Part #RPK407)

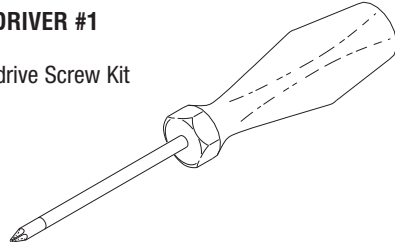

RPT152

POZIDRIVE® SCREWDRIVER #2

- ~8" lg.
- For use with the Pozidrive Screw Kit (RPI Part #RPK407)

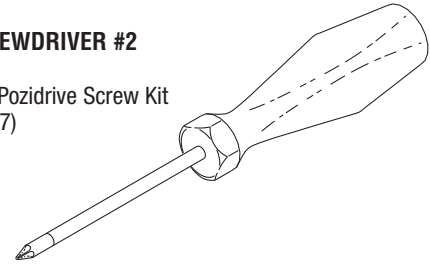

RPI PART #RPK407

METRIC POZIDRIVE® SCREW KIT

- Kit includes 12-compartment storage case (RPI Part #RPB416)
- Stainless steel machine screw
- Screws are also sold separately in quantities indicated below

This screwhead is common in Europe, and seen more frequently in the United States. It looks a lot like a Phillips screwhead, but it includes 4 more contacts. This helps to prevent stripping the screwhead.

RPI PART #	SIZE	QTY
RPH115	M2 x 6 mm lg.	25
RPH116	M2.5 x 6 mm lg.	25
RPH117	M3 x 8 mm lg.	25
RPH118	M4 x 8 mm lg.	25
RPH119	M5 x 10 mm lg.	25
RPH120	M6 x 10 mm lg.	25
RPH121	M2 x 6 mm lg.	25
RPH122	M2.5 x 6 mm lg.	25
RPH123	M3 x 8 mm lg.	25
RPH124	M4 x 8 mm lg.	25
RPH125	M5 x 10 mm lg.	25
RPH126	M6 x 10 mm lg.	25

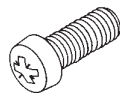

PAN HEAD

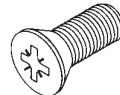

FLAT HEAD

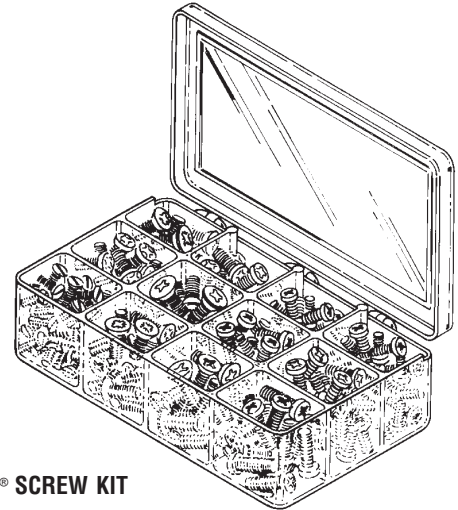

RPK407

METRIC POZIDRIVE® SCREW KIT

RPK408

METRIC PHILLIPS MACHINE SCREW KIT

RPK409

METRIC SLOTTED MACHINE SCREW KIT

RPI PART #RPK408

METRIC PHILLIPS MACHINE SCREW KIT

- Kit includes 12-compartment storage case (RPI Part #RPB416)
- Stainless steel
- Screws are also sold separately in quantities indicated below

RPI PART #	SIZE	QTY
RPH127	M2 x 6 mm lg.	25
RPH128	M2.5 x 6 mm lg.	25
RPH129	M3 x 8 mm lg.	25
RPH130	M4 x 8 mm lg.	25
RPH131	M5 x 10 mm lg.	25
RPH132	M6 x 10 mm lg.	25
RPH133	M2 x 6 mm lg.	25
RPH134	M2.5 x 6 mm lg.	25
RPH135	M3 x 8 mm lg.	25
RPH136	M4 x 8 mm lg.	25
RPH137	M5 x 10 mm lg.	25
RPH138	M6 x 10 mm lg.	25

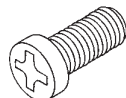

PAN HEAD

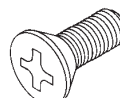

FLAT HEAD

RPI PART #RPK409

METRIC SLOTTED MACHINE SCREW KIT

- Kit includes 12-compartment storage case (RPI Part #RPB416)
- Stainless steel
- Screws are also sold separately in quantities indicated below

RPI PART #	SIZE	QTY
RPH139	M2 x 6 mm lg.	25
RPH140	M2.5 x 6 mm lg.	25
RPH141	M3 x 8 mm lg.	25
RPH142	M4 x 8 mm lg.	25
RPH143	M5 x 10 mm lg.	25
RPH144	M6 x 10 mm lg.	25
RPH145	M2 x 6 mm lg.	25
RPH146	M2.5 x 6 mm lg.	25
RPH147	M3 x 8 mm lg.	25
RPH148	M4 x 8 mm lg.	25
RPH149	M5 x 10 mm lg.	25
RPH150	M6 x 10 mm lg.	25

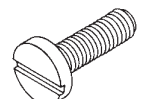

PAN HEAD

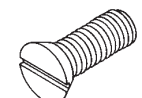

FLAT HEAD



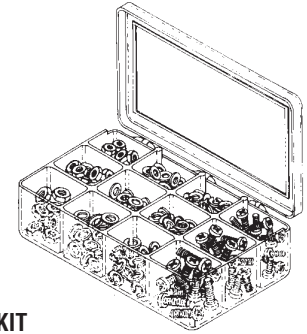

**RPI PART #RPK402
HARDWARE KIT**

- Kit includes 12-compartment storage case (RPI Part #RPB416)
- Stainless steel machine screw
- Hardware is also sold separately in quantities indicated below

RPI PART #	SIZE	TYPE	QTY
RPH101	#6-32 x 1/2" lg.	PHILLIPS PAN HEAD	50
RPH102	#8-32 x 1/2" lg.	PHILLIPS PAN HEAD	50
RPH103	#10-24 x 3/4" lg.	PHILLIPS PAN HEAD	25
RPH104	#6	SPLIT LOCK WASHER	50
RPH105	#8	SPLIT LOCK WASHER	50
RPH106	#10	SPLIT LOCK WASHER	25
RPH107	#6	FLAT WASHER	50
RPH108	#8	FLAT WASHER	50
RPH109	#10	FLAT WASHER	25
RPH110	#6-32	HEX NUT	50
RPH111	#8-32	HEX NUT	50
RPH112	#10-24	HEX NUT	50

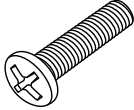

**RPK402
HARDWARE KIT**

 RPH101 - RPH103 PHILLIPS PAN HEAD SCREW	 RPH107 - RPH109 FLAT WASHER
 RPH104 - RPH106 SPLIT LOCK WASHER	 RPH110 - RPH112 HEX NUT

Stainless Steel Lock Washer Kit

**RPI PART #RPK413
LOCKWASHER KIT**

- Kit includes 18-compartment storage case (RPI Part #RPB417)
- Stainless steel
- Lockwashers are also sold separately in quantities indicated below

RPI PART #	SIZE	QTY
RPH173	#4	50
RPH174	#6	50
RPH175	#8	50
RPH176	#10	50
RPH177	1/4"	50
RPH178	5/16"	50
RPH179	3/8"	50
RPH180	7/16"	50
RPH181	1/2"	50
RPH182	#4	50
RPH183	#6	50
RPH184	#8	50
RPH185	#10	50
RPH186	1/4"	50
RPH187	5/16"	50
RPH188	3/8"	50
RPH189	7/16"	50
RPH190	1/2"	50



**INTERNAL TOOTH
LOCK WASHER**



**EXTERNAL TOOTH
LOCK WASHER**

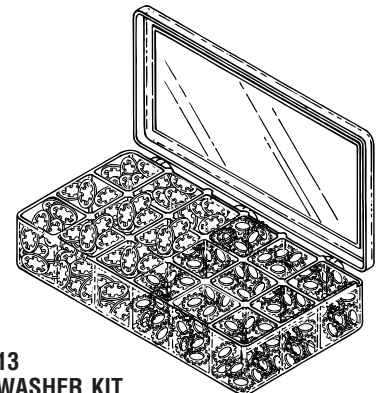

**RPK413
LOCKWASHER KIT**

**RPI Part #RPA032
THREADLOCKER 242**

- 5 per package
- .02 fl. oz. per unit
- Prevents rust and corrosion
- Removable adhesive by Loctite®
- MSDS and Technical Data sheet available on RPI website

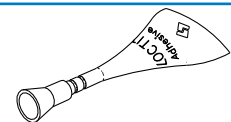

General Shop Aids

O-Ring (References)

ETHYLENE PROPYLENE RUBBER (EPM, EPDM)

Temperature range: -65° to +300°F (-54° to +149°C).

EP is recommended for:

- Phosphate ester base hydraulic fluids
- Steam (to 400°F) (204°C)
- Water
- Silicone oils and greases
- Dilute acids
- Dilute alkalis
- Ketones (MEK, acetone)
- Alcohols

EP is not recommended for:

- Petroleum oils
- Di-ester base lubricants

SILICONE RUBBER (SI)

Temperature range: -65° to +450°F (-54°C to +232°C).

Silicones are recommended for:

- Dynamic sealing application
- Dry heat
- High-aniline point oils
- Chlorinated di-phenyls

Silicones are not recommended for:

- Most petroleum fluids
- Ketones (MEK, acetone)
- Water and steam

FLUOROCARBON RUBBER VITON (FKM)

Temperature range: -15° to +400°F (-29° to +204°C).

FKM is recommended for:

- Petroleum oils
- Di-ester base lubricants
- Silicate ester base lubricants
- Silicone fluids and greases
- Halogenated hydrocarbons (carbon tetrachloride, trichloroethylene)
- Selected phosphate ester fluids
- Acids

FKM is not recommended for:

- Ketones (MEK, acetone)
- Skydrol fluids

NITRILE OR BUNA N (NBR)

Temperature range of -65° to +275°F (-54° to +135°C).

Nitrile is recommended for:

- General purpose sealing
- Petroleum oils and fluids
- Cold water
- Silicone greases and oils
- Di-Ester base lubricants
- Ethylene Glycol base fluids (Hydrolubes)

Nitrile is not recommended for:

- Halogenated hydrocarbons (carbon, tetrachloride, trichloroethylene)
- Nitro hydrocarbons (nitrobenzene, aniline)
- Phosphate ester hydraulic fluids (Skydrol, Fyrquel, Pydraul)
- Ketones (MEK, acetone)
- Strong acids
- Ozone

This information is provided as a guideline and quick reference for approximate identification of an O-ring. There may be many factors that need to be considered when determining proper O-ring material. Further investigation for a given application may be required. In addition, to more accurately determine the dimensions of an O-ring, precision measuring equipment (such as Calipers) should be used.

HOW TO USE THIS CHART

Lay O-ring over cross-section pictorials to determine approximate cross-section diameter. (For best results cut O-ring and place round cross-section onto pictorial.)

STANDARD CROSS-SECTIONS PER AS568A

- .031
- .039
- .041
- QUAD .041
- .051
- .063
- .079
- .080
- .040
- .050
- .060
- .070
- .103
- .139
- .210

OTHER AVAILABLE CROSS-SECTIONS

HOW TO USE THIS CHART

1. Align outer edge of O-ring to the 0.00 line.
2. Read opposite edge of O-ring for approximate outside diameter (O.D.).

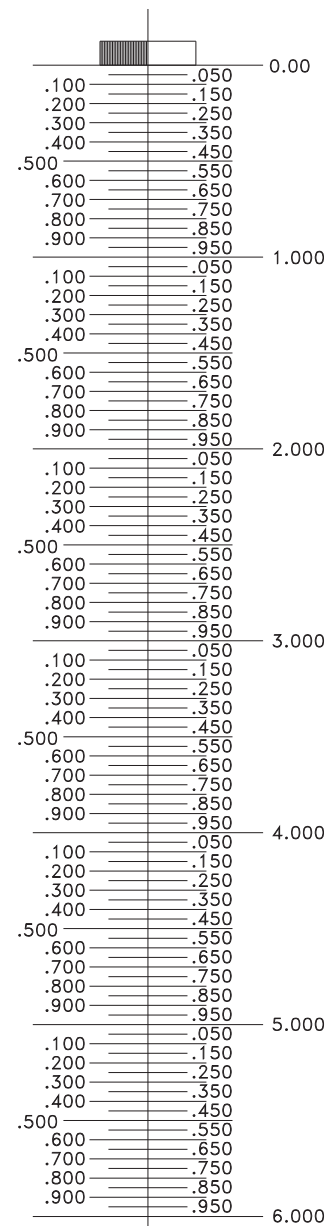

Source of information: Parker O-Ring Handbook, Parker Seals, ORD5700, Parker Hannifin Corporation, Cleveland, OH

O-RING CHART BY SIZE

RPI	PART #	X-SEC	ID	OD	IND PART #	MATERIAL	DURO	QTY
	RP0324	.031	.239	.301	Custom	Nitrile (Buna N)	70	12
	RP0328	.031	.288	.351	Metric	Nitrile (Buna N)	70	12
	RP0493	.038	.032	.108	Custom	EPDM	70	12
	RP0309	.040	.029	.109	AS568A-001	Nitrile (Buna N)	70	12
	RP0308	.040	.070	.150	5-051	Nitrile (Buna N)	70	12
	RP0496	.040	.070	.150	Custom	EPDM	70	12
	RP0494	.040	.176	.256	Custom	EPDM	70	12
	RP0497	.040	.176	.256	Custom	Viton	75	12
	RP0319	.041-Q	.028	.110	Q4001	Nitrile (Buna N)	70	12
	RP0310	.050	.042	.142	AS568A-002	Nitrile (Buna N)	70	12
	RP0352	.050	.042	.142	AS568A-002	Viton	90	12
	RP0486	.050	.042	.142	AS568A-002	EPDM	70	12
	RP0450	.051	.547	.649	5-001	Silicone	70	6
	RP0311	.060	.056	.176	AS568A-003	Nitrile (Buna N)	70	12
	RP0484	.060	.056	.176	AS568A-003	Viton	75	12
	RP0487	.060	.056	.176	AS568A-003	EPDM	70	12
	RP0495	.062	.400	.524	Custom	Viton	75	12
	RP0312	.070	.070	.210	AS568A-004	Nitrile (Buna N)	70	12
	RP0313	.070	.101	.241	AS568A-005	Nitrile (Buna N)	70	12
	RP0489	.070	.101	.241	AS568A-005	EPDM	70	12
	RP0307	.070	.114	.254	AS568A-006	EPDM	70	12
	RP0320	.070	.114	.254	AS568A-006	Viton	70	12
	RP0314	.070	.145	.285	AS568A-007	Nitrile (Buna N)	70	12
	RP0342	.070	.145	.285	AS568A-007	Viton	70	12
	RP0359	.070	.145	.285	AS568A-007	EPDM	70	6
	RP0306	.070	.176	.316	AS568A-008	EPDM	70	12
	RP0327	.070	.176	.316	AS568A-008	Natural Silicone	70	12
	RP0330	.070	.176	.316	AS568A-008	Teflon	n/a	6
	RP0315	.070	.208	.348	AS568A-009	Nitrile (Buna N)	70	12
	RP0339	.070	.208	.348	AS568A-009	Viton	70	12
	RP0492	.070	.208	.348	AS568A-009	Silicone	70	12
	RP0305	.070	.239	.379	AS568A-010	Nitrile (Buna N)	70	12
	RP0329	.070	.239	.379	AS568A-010	Teflon	n/a	6
	RP0386	.070	.239	.379	AS568A-010	Silicone	70	6
	RP0304	.070	.301	.441	AS568A-011	Nitrile (Buna N)	70	12
	RP0331	.070	.301	.441	AS568A-011	Neoprene	70	6
	RP0343	.070	.301	.441	AS568A-011	Silicone	70	12
	RP0360	.070	.301	.441	AS568A-011	EPDM	80	6
	RP0385	.070	.301	.441	AS568A-011	Viton	60	12
	RP0303	.070	.364	.504	AS568A-012	Nitrile (Buna N)	70	12
	RP0498	.070	.364	.504	AS568A-012	EPDM	70	12

RPI	PART #	X-SEC	ID	OD	IND PART #	MATERIAL	DURO	QTY
	RP0302	.070	.426	.566	AS568A-013	Nitrile (Buna N)	70	12
	RP0388	.070	.426	.566	AS568A-013	Silicone	70	6
	RP0485	.070	.426	.566	AS568A-013	EPDM	70	12
	RP0301	.070	.489	.629	AS568A-014	Nitrile (Buna N)	70	12
	RP0326	.070	.489	.629	AS568A-014	Viton	70	12
	RP0488	.070	.489	.625	AS568A-014	EPDM	70	12
	RP0316	.070	.551	.691	AS568A-015	Nitrile (Buna N)	70	12
	RP0341	.070	.551	.691	AS568A-015	Viton	70	12
	RP0439	.070	.551	.691	AS568A-015	EPDM	70	6
	RP0317	.070	.614	.754	AS568A-016	Nitrile (Buna N)	70	12
	RP0318	.070	.676	.816	AS568A-017	Nitrile (Buna N)	70	12
	RP0334	.070	.739	.879	AS568A-018	Nitrile (Buna N)	70	12
	RP0340	.070	.739	.879	AS568A-018	Viton	70	12
	RP0490	.070	.739	.879	AS568A-018	EPDM	70	12
	RP0325	.070	.801	.941	AS568A-019	Nitrile (Buna N)	70	12
	RP0355	.070	.801	.941	AS568A-019	Silicone	70	6
	RP0444	.070	.801	.941	AS568A-019	EPDM	70	12
	RP0438	.070	.864	1.004	AS568A-020	EPDM	70	12
	RP0354	.070	.926	1.066	AS568A-021	Silicone	70	6
	RP0322	.070	1.051	1.191	AS568A-023	Nitrile (Buna N)	70	12
	RP0390	.070	1.114	1.254	AS568A-024	Silicone	70	6
	RP0335	.070	1.489	1.629	AS568A-029	Nitrile (Buna N)	70	12
	RP0344	.070	2.239	2.379	AS568A-035	Nitrile (Buna N)	70	6
	RP0321	.070	2.114	2.254	AS568A-034	Nitrile (Buna N)	70	12
	RP0491	.103	.206	.412	AS568A-107	EPDM	70	12
	RP0448	.103	.237	.443	AS568A-108	EPDM	70	6
	RP0323	.103	.362	.568	AS568A-110	Nitrile (Buna N)	70	12
	RP0387	.103	.362	.568	AS568A-110	Silicone	70	6
	RP0395	.103	.362	.568	AS568A-110	EPDM	70	12
	RP0356	.103	.424	.630	AS568A-111	Nitrile (Buna N)	70	12
	RP0357	.103	.424	.630	AS568A-111	EPDM	70	12
	RP0353	.103	.487	.693	AS568A-112	Nitrile (Buna N)	70	12
	RP0358	.103	.549	.755	AS568A-113	EPDM	80	6
	RP0389	.103	1.049	1.255	AS568A-121	Silicone	70	6
	RP0346	.103	2.425	2.631	AS568A-143	Nitrile (Buna N)	70	12
	LI0005	.103	3.987	4.193	AS568A-155	Nitrile (Buna N)	70	1
	RP0244	.139	.296	.574	AS568A-203	Silicone	60	6
	RP0350	.139	.796	1.074	AS568A-211	Nitrile (Buna N)	70	12
	RP0345	.139	4.359	4.637	AS568A-245	Nitrile (Buna N)	70	6
	RP0361	.210	.912	1.332	AS568A-317	Nitrile (Buna N)	70	6

O-rings are sold separately in quantities indicated above. For O-ring Kits, see pages 503-504.

O-RING CHART BY RPI PART

RPI PART #	X-SEC	ID	OD	IND PART #	MATERIAL	DURO	QTY
LI0005	.103	3.987	4.193	AS568A-155	Nitrile (Buna N)	70	1
RP0244	.139	.296	.574	AS568A-203	Silicone	60	6
RP0301	.070	.489	.629	AS568A-014	Nitrile (Buna N)	70	12
RP0302	.070	.426	.566	AS568A-013	Nitrile (Buna N)	70	12
RP0303	.070	.364	.504	AS568A-012	Nitrile (Buna N)	70	12
RP0304	.070	.301	.441	AS568A-011	Nitrile (Buna N)	70	12
RP0305	.070	.239	.379	AS568A-010	Nitrile (Buna N)	70	12
RP0306	.070	.176	.316	AS568A-008	EPDM	70	12
RP0307	.070	.114	.254	AS568A-006	EPDM	70	12
RP0308	.040	.070	.150	5-051	Nitrile (Buna N)	70	12
RP0309	.040	.029	.109	AS568A-001	Nitrile (Buna N)	70	12
RP0310	.050	.042	.142	AS568A-002	Nitrile (Buna N)	70	12
RP0311	.060	.056	.176	AS568A-003	Nitrile (Buna N)	70	12
RP0312	.070	.070	.210	AS568A-004	Nitrile (Buna N)	70	12
RP0313	.070	.101	.241	AS568A-005	Nitrile (Buna N)	70	12
RP0314	.070	.145	.285	AS568A-007	Nitrile (Buna N)	70	12
RP0315	.070	.208	.348	AS568A-009	Nitrile (Buna N)	70	12
RP0316	.070	.551	.691	AS568A-015	Nitrile (Buna N)	70	12
RP0317	.070	.614	.754	AS568A-016	Nitrile (Buna N)	70	12
RP0318	.070	.676	.816	AS568A-017	Nitrile (Buna N)	70	12
RP0319	.041-Q	.028	.110	Q4001	Nitrile (Buna N)	70	12
RP0320	.070	.114	.254	AS568A-006	Viton	70	12
RP0321	.070	2.114	2.254	AS568A-034	Nitrile (Buna N)	70	12
RP0322	.070	1.051	1.191	AS568A-023	Nitrile (Buna N)	70	12
RP0323	.103	.362	.568	AS568A-110	Nitrile (Buna N)	70	12
RP0324	.031	.239	.301	Custom	Nitrile (Buna N)	70	12
RP0325	.070	.801	.941	AS568A-019	Nitrile (Buna N)	70	12
RP0326	.070	.489	.629	AS568A-014	Viton	70	12
RP0327	.070	.176	.316	AS568A-008	Natural Silicone	70	12
RP0328	.031	.288	.351	Metric	Nitrile (Buna N)	70	12
RP0329	.070	.239	.379	AS568A-010	Teflon	n/a	6
RP0330	.070	.176	.316	AS568A-008	Teflon	n/a	6
RP0331	.070	.301	.441	AS568A-011	Neoprene	70	6
RP0334	.070	.739	.879	AS568A-018	Nitrile (Buna N)	70	12
RP0335	.070	1.489	1.629	AS568A-029	Nitrile (Buna N)	70	12
RP0339	.070	.208	.348	AS568A-009	Viton	70	12
RP0340	.070	.739	.879	AS568A-018	Viton	70	12
RP0341	.070	.551	.691	AS568A-015	Viton	70	12
RP0342	.070	.145	.285	AS568A-007	Viton	70	12
RP0343	.070	.301	.441	AS568A-011	Silicone	70	12
RP0344	.070	2.239	2.379	AS568A-035	Nitrile (Buna N)	70	6

RPI PART #	X-SEC	ID	OD	IND PART #	MATERIAL	DURO	QTY
RP0345	.139	4.359	4.637	AS568A-245	Nitrile (Buna N)	70	6
RP0346	.103	2.425	2.631	AS568A-143	Nitrile (Buna N)	70	12
RP0350	.139	.796	1.074	AS568A-211	Nitrile (Buna N)	70	12
RP0352	.050	.042	.142	AS568A-002	Viton	90	12
RP0353	.103	.487	.693	AS568A-112	Nitrile (Buna N)	70	12
RP0354	.070	.926	1.066	AS568A-021	Silicone	70	6
RP0355	.070	.801	.941	AS568A-019	Silicone	70	6
RP0356	.103	.424	.630	AS568A-111	Nitrile (Buna N)	70	12
RP0357	.103	.424	.630	AS568A-111	EPDM	70	12
RP0358	.103	.549	.755	AS568A-113	EPDM	80	6
RP0359	.070	.145	.285	AS568A-007	EPDM	70	6
RP0360	.070	.301	.441	AS568A-011	EPDM	80	6
RP0361	.210	.912	1.332	AS568A-317	Nitrile (Buna N)	70	6
RP0385	.070	.301	.441	AS568A-011	Viton	60	12
RP0386	.070	.239	.379	AS568A-010	Silicone	70	6
RP0387	.103	.362	.568	AS568A-110	Silicone	70	6
RP0388	.070	.426	.566	AS568A-013	Silicone	70	6
RP0389	.103	1.049	1.255	AS568A-121	Silicone	70	6
RP0390	.070	1.114	1.254	AS568A-024	Silicone	70	6
RP0395	.103	.362	.568	AS568A-110	EPDM	70	12
RP0438	.070	.864	1.004	AS568A-020	EPDM	70	12
RP0439	.070	.551	.691	AS568A-015	EPDM	70	6
RP0444	.070	.801	.941	AS568A-019	EPDM	70	12
RP0448	.103	.237	.443	AS568A-108	EPDM	70	6
RP0450	.051	.547	.649	5-001	Silicone	70	6
RP0484	.060	.056	.176	AS568A-003	Viton	75	12
RP0485	.070	.426	.566	AS568A-013	EPDM	70	12
RP0486	.050	.042	.142	AS568A-002	EPDM	70	12
RP0487	.060	.056	.176	AS568A-003	EPDM	70	12
RP0488	.070	.489	.625	AS568A-014	EPDM	70	12
RP0489	.070	.101	.241	AS568A-005	EPDM	70	12
RP0490	.070	.739	.879	AS568A-018	EPDM	70	12
RP0491	.103	.206	.412	AS568A-107	EPDM	70	12
RP0492	.070	.208	.348	AS568A-009	Silicone	70	12
RP0493	.038	.032	.108	Custom	EPDM	70	12
RP0494	.040	.176	.256	Custom	EPDM	70	12
RP0495	.062	.400	.524	Custom	Viton	75	12
RP0496	.040	.070	.150	Custom	EPDM	70	12
RP0497	.040	.176	.256	Custom	Viton	75	12
RP0498	.070	.364	.504	AS568A-012	EPDM	70	12

O-rings are sold separately in quantities indicated above. For O-ring Kits, see pages 503-504.

RPI Part #RPK481

O-RING INSTALLATION TOOLS

- Three sizes
- Accommodates O-rings with ID of .029" through .208"
- Stainless steel
- ~1-3/4" lg.

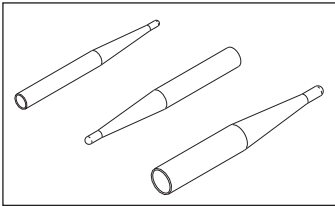

RPI Part #RPK581

O-RING REMOVAL TOOLS

- Pointed ends for hard to reach areas
- Blunt ends for larger surfaces
- Brass (to reduce potential o-ring groove damage)
- ~5-1/2" lg.

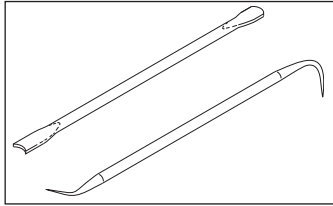

RPI Part #RPL090

HIGH TEMP LUBRICANT

- 5 per package
- 1/2 gram per unit
- Non-silicone lubricant
- Temperature range: -40° to +400°F (-40° to +204°C)
- MSDS and Technical Data sheet available on RPI website

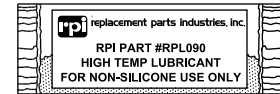

RPI PART #RPK403

O-RING KIT

- Kit includes 8-compartment storage case (RPI Part #RPB414)
- O-rings are also sold separately in quantities indicated below

RPI

PART #	X-SEC	ID	OD	IND PART #	MATERIAL	DURO	QTY
RPO301	.070	.489	.629	AS568A-014	Nitrile (Buna N)	70	12
RPO302	.070	.426	.566	AS568A-013	Nitrile (Buna N)	70	12
RPO303	.070	.364	.504	AS568A-012	Nitrile (Buna N)	70	12
RPO304	.070	.301	.441	AS568A-011	Nitrile (Buna N)	70	12
RPO305	.070	.239	.379	AS568A-010	Nitrile (Buna N)	70	12
RPO306	.070	.176	.316	AS568A-008	EPDM	70	12
RPO307	.070	.114	.254	AS568A-006	EPDM	70	12
RPO308	.040	.070	.150	5-051	Nitrile (Buna N)	70	12

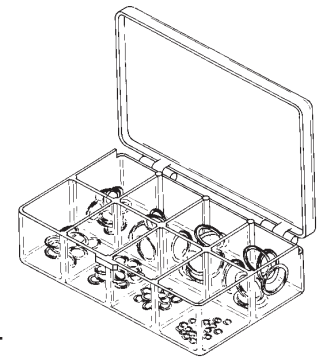

RPK403
O-RING KIT

RPI PART #RPK404

O-RING KIT

- Kit includes 18-compartment storage case (RPI Part #RPB417)
- O-rings are also sold separately in quantities indicated below

RPI

PART #	X-SEC	ID	OD	IND PART #	MATERIAL	DURO	QTY
RPO301	.070	.489	.629	AS568A-014	Nitrile (Buna N)	70	12
RPO302	.070	.426	.566	AS568A-013	Nitrile (Buna N)	70	12
RPO303	.070	.364	.504	AS568A-012	Nitrile (Buna N)	70	12
RPO304	.070	.301	.441	AS568A-011	Nitrile (Buna N)	70	12
RPO305	.070	.239	.379	AS568A-010	Nitrile (Buna N)	70	12
RPO306	.070	.176	.316	AS568A-008	EPDM	70	12
RPO307	.070	.114	.254	AS568A-006	EPDM	70	12
RPO308	.040	.070	.150	5-051	Nitrile (Buna N)	70	12
RPO309	.040	.029	.109	AS568A-001	Nitrile (Buna N)	70	12
RPO310	.050	.042	.142	AS568A-002	Nitrile (Buna N)	70	12
RPO311	.060	.056	.176	AS568A-003	Nitrile (Buna N)	70	12
RPO312	.070	.070	.210	AS568A-004	Nitrile (Buna N)	70	12
RPO313	.070	.101	.241	AS568A-005	Nitrile (Buna N)	70	12
RPO314	.070	.145	.285	AS568A-007	Nitrile (Buna N)	70	12
RPO315	.070	.208	.348	AS568A-009	Nitrile (Buna N)	70	12
RPO316	.070	.551	.691	AS568A-015	Nitrile (Buna N)	70	12
RPO317	.070	.614	.754	AS568A-016	Nitrile (Buna N)	70	12
RPO318	.070	.676	.816	AS568A-017	Nitrile (Buna N)	70	12

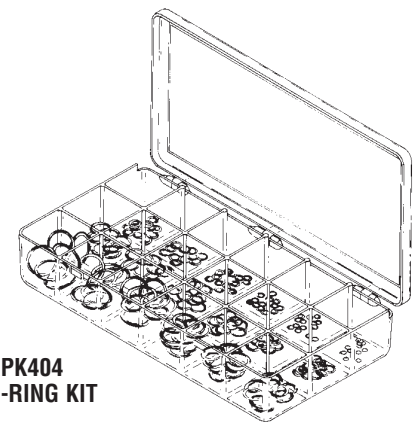

RPK404
O-RING KIT

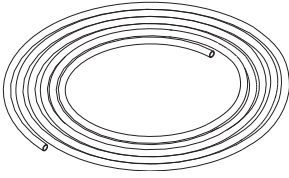

RPI Part #RPT544

3/16" COPPER TUBING

- .188" OD x .030" wall
- Soft annealed copper
- 10 ft. flat pack coil
- Suitable for compressed air, steam, water, vacuum or hydraulic applications
- Not for use in oxygen system



RPI Part #RPT545

1/4" COPPER TUBING

- .250" OD x .030" wall
- Soft annealed copper
- 10 ft. flat pack coil
- Suitable for compressed air, steam, water, vacuum or hydraulic applications
- Not for use in oxygen system



RPI Part #RPT546

5/16" COPPER TUBING

- .312" OD x .032" wall
- Soft annealed copper
- 10 ft. flat pack coil
- Suitable for compressed air, steam, water, vacuum or hydraulic applications
- Not for use in oxygen system



RPI Part #RPT547

3/8" COPPER TUBING

- .375" OD x .032" wall
- Soft annealed copper
- 10 ft. flat pack coil
- Suitable for compressed air, steam, water, vacuum or hydraulic applications
- Not for use in oxygen system



RPI Part #RPT548

METAL TUBING CUTTER

- ~2" lg.
- Chromed steel
- 1/8" - 5/8" OD tubing capacity
- Can be used where clearance around tubing is limited.

- Replaceable cutting wheel (RPI Part #RPT549)
- Made by Blue Point® for Snap-On®

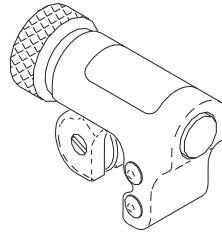

RPI Part #RPT549

TUBING CUTTER WHEEL

- Carbon steel
- Replacement part for RPI Part #RPT548



RPI Part #RPT550

METAL TUBING BENDER

- ~8-1/4" lg.
- Handles 3/16", 1/4", 5/16" and 3/8" OD metal tubing
- Made by Blue Point® for Snap-On®
- Makes left, right or offset bends up to 90°

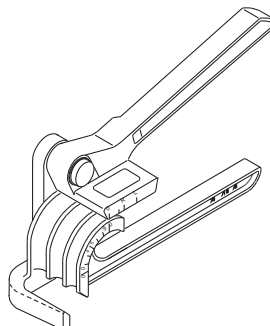

RPI Part #RPT579

1/4" TEFLON THREAD SEALING TAPE

- 5 per package
- 1/4" x 260" per unit

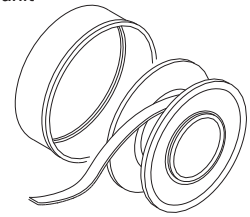

RPI Part #RPT580

1/2" TEFLON THREAD SEALING TAPE

- 5 per package
- 1/2" x 260" per unit

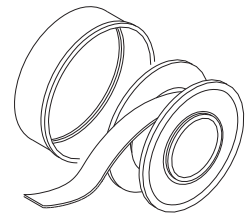

RPI Part #RPA459

PIPE SEALANT 567

- .20 fl. oz. (6ml)
- Temperature range: -65° to 400°F (-54° to 204°C)
- MSDS and Technical Data sheet available on RPI website

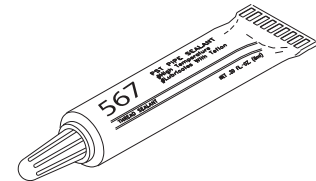

RPI Part #RPA369

THREADLOCKER 545

- 5 per package
- .02 fl. oz. per unit
- Temperature range of -65° to 300°F (-54° to 149°C)
- Seals operating pressures up to 10,000 PSI
- For use on all pneumatic and hydraulic fittings
- MSDS and Technical Data sheet available on RPI website

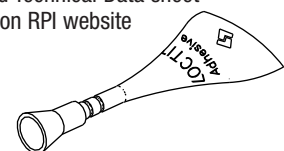

General Shop Aids

Plumbing (Compression Fittings, and Accessories)

RPI Part #RPA369

THREADLOCKER 545

- 5 per package
- .02 fl. oz. per unit
- Temperature range of -65° to 300°F (-54° to 149°C)
- Seals operating pressures up to 10,000 PSI
- For use on all pneumatic and hydraulic fittings
- MSDS and Technical Data sheet available on RPI website

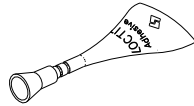

RPI Part #RPA459

PIPE SEALANT 567

- .20 fl. oz. (6ml) per unit
- Temperature range: -65° to 400°F (-54° to 204°C)
- MSDS and Technical Data sheet available on RPI website

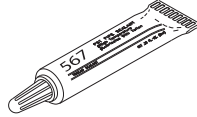

RPI Part #RPT579

1/4" TEFLON THREAD SEALING TAPE

- 5 per package
- 1/4" x 260" per unit

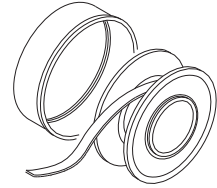

RPI Part #RPT580

1/2" TEFLON THREAD SEALING TAPE

- 5 per package
- 1/2" x 260" per unit

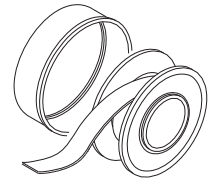

RPK420
COMPRESSION FITTING KIT

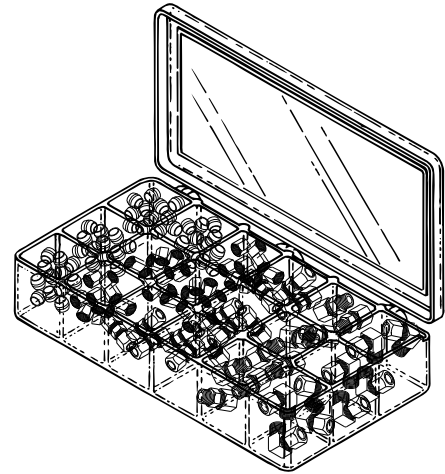

RPI PART #RPK420

COMPRESSION FITTING KIT

- Kit includes 18-compartment storage case (RPI Part #RPB419)
- Brass
- Fittings also sold separately in quantities indicated below

RPI PART #	FITS TUBE OD	PIPE THREADS	STRAIGHT THREADS	HEX SIZE	QTY
RPF215	3/16" OD	N/A	N/A	N/A	5
RPF216	1/4" OD	N/A	N/A	N/A	10
RPF217	5/16" OD	N/A	N/A	N/A	5
RPF218	3/8" OD	N/A	N/A	N/A	5
RPF219	3/16" OD	N/A	3/8-24	7/16"	5
RPF220	1/4" OD	N/A	7/16-24	1/2"	5
RPF221	5/16" OD	N/A	1/2-24	9/16"	5
RPF222	3/8" OD	N/A	9/16-24	5/8"	5
RPF223	3/16" OD	N/A	3/8-24	7/16"	5
RPF224	1/4" OD	N/A	7/16-24	1/2"	5
RPF225	5/16" OD	N/A	1/2-24	9/16"	5
RPF226	3/8" OD	N/A	9/16-24	5/8"	2
RPF227	3/16" OD	1/8 MPT	3/8-24	7/16"	2
RPF228	1/4" OD	1/8 MPT	7/16-24	1/2"	5
RPF229	5/16" OD	1/8 MPT	1/2-24	9/16"	2
RPF230	3/16" OD	1/8 MPT	3/8-24	N/A	2
RPF231	1/4" OD	1/8 MPT	7/16-24	N/A	5
RPF232	5/16" OD	1/8 MPT	1/2-24	N/A	2



RPF215 - RPF218
COMPRESSION SLEEVE



RPF219 - RPF222
COMPRESSION NUT

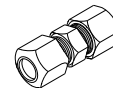

RPF223 - RPF226
COMPRESSION UNION



RPF227 - RPF229
MALE CONNECTOR



RPF230 - RPF232
MALE ELBOW

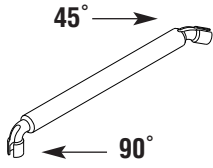

RPI Part #RPT294

1/8" SLEEVE TOOL

- Use on 1/8" OD tubing
- The tool provides 90° and 45° angles for ease of use
- ~5" lg.

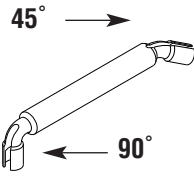

RPI Part #RPT295

1/4" SLEEVE TOOL

- Use on 1/4" OD tubing
- The tool provides 90° and 45° angles for ease of use
- ~5" lg.

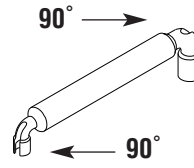

RPI Part #RPT296

UNIVERSAL SLEEVE TOOL

- Use on 1/8" OD tubing and 1/4" OD tubing
- The tool provides 90° angles on both ends for ease of use
- ~5" lg.

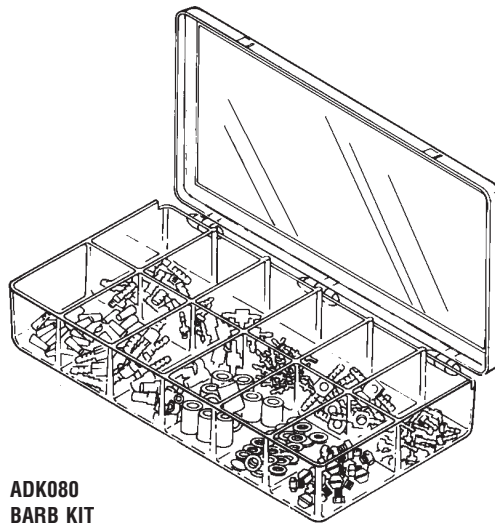

ADK080
BARB KIT

**RPI PART #ADK080
BARB KIT**

- Kit includes 12-compartment storage case (RPI Part #RPB415)
- Barbs are also sold separately in quantities indicated below

RPI PART #	DESCRIPTION	MATERIAL	FITS	KIT QTY	REORDER QTY
ADB011	1/8" BARB TO #10-32 MALE THREAD	BRASS	1/8" ID TUBING	20	10
ADB012	1/16" BARB TO #10-32 MALE THREAD	BRASS	1/16" ID TUBING	20	10
ADB013	1/16" BARB TEE	NYLON	1/16" ID TUBING	20	10
ADB014	1/16" INLINE BARB	BRASS	1/16" ID TUBING	20	10
ADB015	1/8" BARB TEE-BODY WITH #10-32 FEMALE THREAD	BRASS	1/8" ID TUBING	10	5
ADB016	1/16" BARB TUBING PLUG	BRASS	1/16" ID TUBING	20	10
ADB018	1/8" INLINE BARB	BRASS	1/8" ID TUBING	10	5
ADC017	1/16" BARB CAP	POLYURETHANE	1/16" ID BARB	20	10
ADC034	UNI-CLAMP	DELIRIN	1/8" OD BARB	40	20
ADC035	SLEEVE CLAMP	POLYETHYLENE	1/4" OD TUBING	20	20
ADP057	HEX PLUG WITH #10-32 MALE THREAD	BRASS	#10-32 FEMALE THREAD	20	10
ADW038	FLAT WASHER (.187" ID x .312" OD x .031" Thk)	NYLON	#10-32 MALE THREAD	100	50

ADB011 BARB	
ADB012 BARB	
ADB013 BARB TEE	
ADB014 INLINE BARB	
ADB015 BARB TEE-BODY	
ADB016 BARB TUBING PLUG	
ADB018 INLINE BARB	
ADC017 BARB CAP	
ADC034 UNI-CLAMP	
ADC035 SLEEVE CLAMP	
ADP057 HEX PLUG	
ADW038 FLAT WASHER	

General Shop Aids

Tools

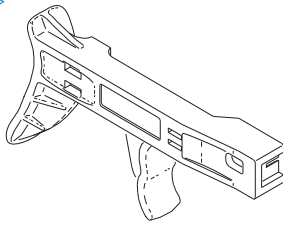

RPI Part #RPT477

CABLE TIE TOOL

- Plastic
- Use this tool for applying a wide variety of ties making for fast application and a clean cut-off
- A lightweight pocket sized tool
- .094" to .184" tie width
- ~6-1/2" lg.
- Made by Thomas & Betts

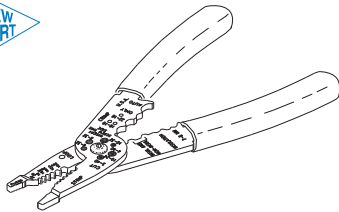

RPI Part #RPT482

TERMINAL CRIMP TOOL

- ~8-1/4" lg.
- Steel with cushion grip handles
- Wire stripper - AWG #10 to #22
- Crimps #10 to #22 insulated and non-insulated terminals
- Cuts #4-40 to #10-32 screws
- Hardened pivot joint bushing for long life
- Includes pliers at tip, wire loop former and wire cutter
- Made by Blue Point® for Snap-On®

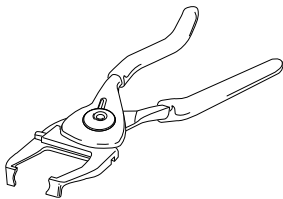

RPI Part #RPT172

STRAIN RELIEF BUSHING PLIERS

- Hand pliers adjustable for all bushings that assemble into mounting hole up to 7/8" diameter
- ~7" lg.

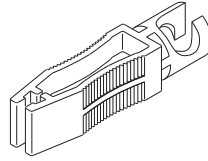

RPI Part #RPT502

FUSE PULLER

- ~2" lg.
- Yellow polycarbonate
- Non-slip handle
- Removes or installs glass, ceramic or blade style fuses
- Ideal for tight spaces

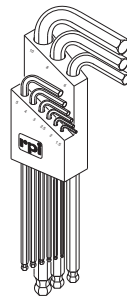

RPI Part #RPT539

L-HEX WRENCH SET (METRIC)

- 9 piece set
- 1.5mm through 10mm
- Corrosion protected steel
- Made by Bondus®

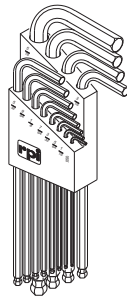

RPI Part #RPT540

L-HEX WRENCH SET (INCH)

- 13 piece set
- .050" through 3/8"
- Corrosion protected steel
- Made by Bondus®

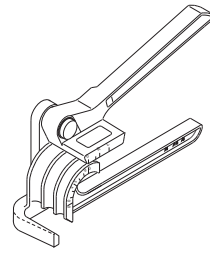

RPI Part #RPT550

METAL TUBING BENDER

- ~8-1/4" lg.
- Handles 3/16", 1/4", 5/16" and 3/8" OD metal tubing
- Made by Blue Point® for Snap-On®
- Makes left, right or offset bends up to 90°

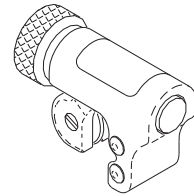

RPI Part #RPT548

METAL TUBING CUTTER

- ~2" lg.
- Chromed steel
- 1/8" - 5/8" OD tubing capacity
- Can be used where clearance around tubing is limited.
- Replaceable cutting wheel (RPI Part # RPT549)
- Made by Blue Point® for Snap-On®



RPI Part #RPT549

TUBING CUTTER WHEEL

- Carbon steel
- Replacement part for RPI Part #RPT548

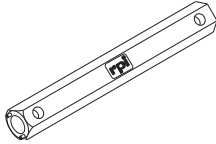

RPI Part #RPT501

DOUBLE ENDED SPANNER WRENCH

- ~7" lg.; .875" Hex
- Dimensions at one end: .453" ID; .062" pin diameter at .587" apart. Dimensions at other end: .530" ID; .094" pin diameter at .750" apart
- Stainless steel
- Can be used in place of the Spanner Nuts (RPI Part #'s ILS014 and RPT364)
- Convenient to use when repairing difficult to reach solenoid valves in Pelton & Crane, Midmark, and Scican sterilizers, and Instrumentation Laboratories analyzers

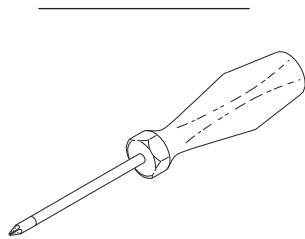

RPI Part #RPT151

POZIDRIVE® SCREWDRIVER #1

- ~6-1/2" lg.

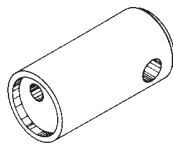

RPI Part #STT010

CAM TOOL

- ~3/4" dia. x 1-1/2" lg.
- Stainless steel
- To install/remove cam that fits Stryker cast cutter saws

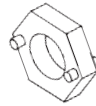

RPI Part #ILS014

SPANNER NUT

- ID: .525", Hex: .875", Thk: .250"
- Dimensions: .109" diameter dowel pins at .750" apart
- Stainless steel
- For use when repairing solenoid valves in Midmark and Pelton & Crane sterilizers, and Instrumentation Laboratories analyzers

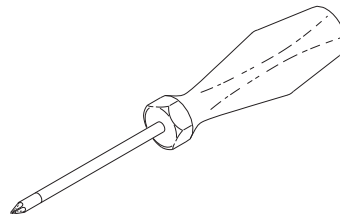

RPI Part #RPT152

POZIDRIVE® SCREWDRIVER #2

- ~8" lg.

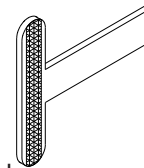

RPI Part #RPT092

VALVE SEAT WRENCH

- Stainless steel
- Use to remove and install air valve seat and body
- ~3" lg. x 2-3/4"

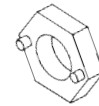

RPI Part #RPT364

SPANNER NUT

- ID: .453", Hex: .750", Thk: .250"
- Dimensions: .062" diameter dowel pins at .587" apart
- Stainless steel
- For use when repairing solenoid valves in Scican sterilizers

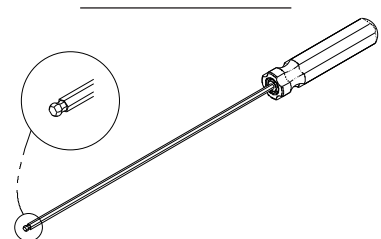

RPI Part #RPT297

5/64" HEX x 7" LONG BALLDRIVER

- 5/64" hex
- 7" long steel tool with plastic handle
- Precision ballpoint

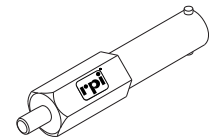

RPI Part #RPT271

VALVE SEAT TOOL

- 3-3/8" lg. x 5/8" Hex
- Stainless steel
- For installation and removal of air valve seat and body on Pelton & Crane sterilizers



RPI Part #RPT460

TRIM POT ADJUSTMENT TOOL

- ~5" lg.
- Plastic with stainless steel blades
- Includes shirt pocket clip
- Fits most trim pots

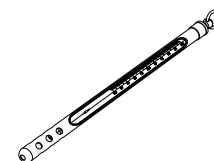

RPI Part #RPT113

MAX REGISTER THERMOMETER

- Mercury
- Length: 5-1/2"
- Accuracy Rating: ±1Division (±2°F)
- Range: 150° F to 350° F
- Includes thermometer, and metal protective case
- Use for temperature verification in sterilizers

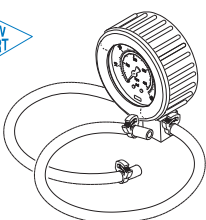

RPT462 12" (x2)
For replacement tubing by the foot, see RPT462

RPI Part #RPG461

TEST PRESSURE GAUGE

- Includes all parts as shown
- Dual gauge display: 0-60 PSI/0-400 KPA
- Gauge has rubber cover protector
- Tubing length on each side: 12" lg.
- Can be used on most sterilizers for in-line pressure check

General Shop Aids

Tools - Continued

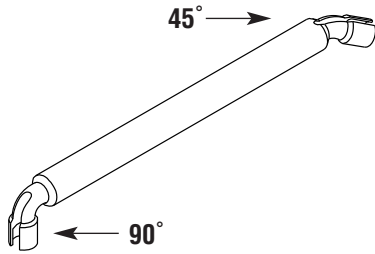

RPI Part #RPT294

1/8" SLEEVE TOOL

- Use on 1/8" OD tubing
- Use to install 1/8" Sleeve clamps and Uni-clamp (RPI Part #ADC034)
- The tool provides 90° and 45° angles for ease of use
- ~5" lg.

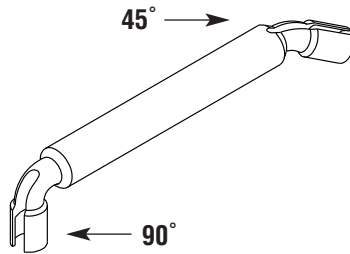

RPI Part #RPT295

1/4" SLEEVE TOOL

- Use on 1/4" OD tubing
- Use to install 1/4" Sleeve clamps and Uni-clamp (RPI Part #ADC035)
- The tool provides 90° and 45° angles for ease of use
- ~5" lg.

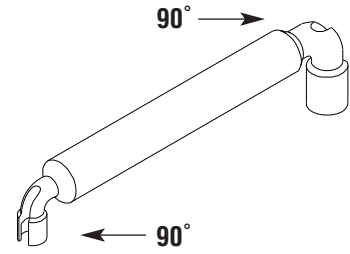

RPI Part #RPT296

UNIVERSAL SLEEVE TOOL

- Use on 1/4" OD tubing and 1/8" OD tubing
- Use to install 1/4" Sleeve clamp (RPI Part #ADC035) and 1/8" Uni-clamp (RPI Part #ADC034)
- The tool provides 90° angles on both ends for ease of use
- ~5" lg.

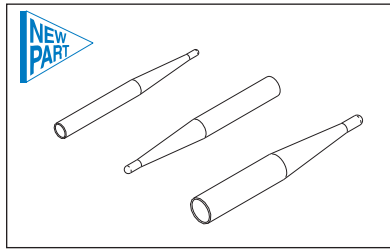

RPI Part #RPK481

O-RING INSTALLATION TOOLS

- Three sizes
- Accommodates O-rings with ID of .029" through .208"
- Stainless steel
- ~1-3/4" lg.

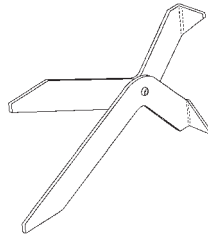

RPI Part #PCT685

SOCKET RETRACTOR TOOL

- ~3-1/4" lg. x 3-1/4"
- For installation and removal of the light bulb used in the Pelton & Crane LF units

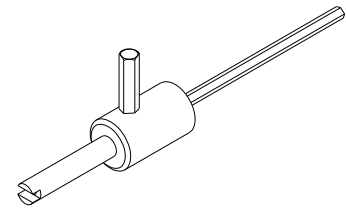

RPI Part #RPT264

VALVE CORE REMOVAL SYRINGE TOOL

- Long Allen 3/32"; Short Allen 5/32"
- Stainless steel
- ~3" lg.
- Syringe repair tool
- Removal tool for use with Valve Core (RPI Part #ADV001)

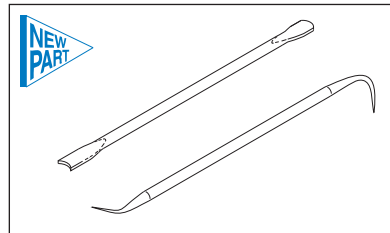

RPI Part #RPK581

O-RING REMOVAL TOOLS

- Pointed ends for hard to reach areas
- Blunt edges for larger surfaces
- Brass to reduce potential o-ring groove damage
- ~6" lg.

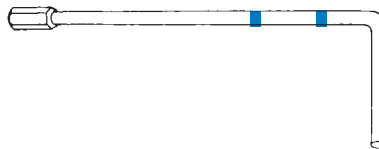

RPI Part #PCT615

GAS SPRING TOOL

- For gas/mechanical spring adjustment
- Chrome plated
- 5/16" hex
- ~10" lg. x 3-1/4"
- Includes markings on tool indicating the point to STOP when making adjustments to the Pelton & Crane ceiling lights or unit lights

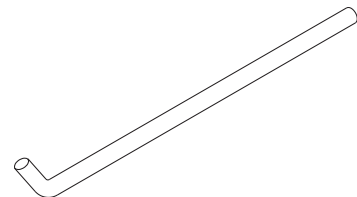

RPI Part #BET029

AJUSTMENT TOOL (SPRING TENSION)

- Used to adjust spring tension and head position on the Belmont and Healthco X-Calibur models

PLASTIC & METAL TUBING SNAKES

Plastic Tubing Snake
RPI Part #RPT620

1/4-20

Accessory Pouch (5" w x 4" h)
RPI Part #RPP634

Bullet Tip (5/16" dia.)
RPI Part #RPA627

Flexible Extension
RPI Part #RPA625

Metal Tubing Snake
RPI Part #RPT629

#10-32

Accessory Pouch (5" w x 4" h)
RPI Part #RPP634

Bullet Tip (1/4" dia.)
RPI Part #RPA633

PLASTIC TUBING SNAKE
RPI Part #RPT620



- OEM Part #: (No OEM Part # Available)
- 15' of 3/16" dia. non-conductive fiberglass rod with PVC holder
 - Includes Bullet Tip (RPI Part #RPA627), Flexible Extension (RPI Part #RPA625), and Accessory Pouch (RPI Part #RPP634)
 - One end has fixed 3/16" dia. brass tip with 1/8" dia. hole; Opposite end has a 1/4-20 male thread adapter for adding attachments
 - With Connector (RPI Part #RPA621), two Plastic Tubing Snakes can be joined together for those longer reach jobs
 - Minimum bend radius: 2.5"

METAL TUBING SNAKE
RPI Part #RPT629



- OEM Part#: (No OEM Part # Available)
- 12' of 1/8" dia. flex cable
 - Includes Bullet Tip (RPI Part #RPA633), and Accessory Pouch (RPI Part #RPP634)
 - One end has a fixed 3/16" dia. brass tip with 1/8" dia. hole; Opposite end has a #10-32 male thread adapter for adding attachments
 - With Connector (RPI Part #RPA631), two Metal Snakes can be joined together for those longer reach jobs
 - Minimum bend radius: 3/4"

FLEXIBLE EXTENSION
RPI Part #RPA625



- 3" long
- Fits:** Plastic Tubing Snake

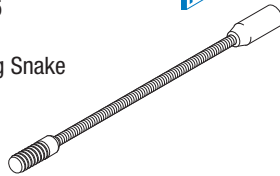

BULLET TIP (5/16" dia.)
RPI Part #RPA627



- 5/16" dia. body with 3/16" dia. hole
- Fits:** Plastic Tubing Snake

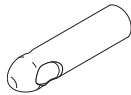

FIBER-OPTIC PULLER (5/16" dia.)
RPI Part #RPA623



- Includes (1) #6-32 x 3/32" lg set screw to lock fiber-optic tube in place
 - 5/16" dia. Bullet Tip
 - 1-3/8" lg.
- Fits:** Plastic Tubing Snake

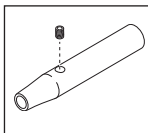

CONNECTOR (PLASTIC SNAKE)
RPI Part #RPA621



- Allows two Plastic Snakes to be connected for a 30' reach
- Fits:** Plastic Tubing Snake

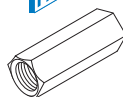

THE ATTACHMENTS SHOWN BELOW FIT BOTH SNAKES!

The Metal Snake requires the Adapter - RPI Part #RPA631

HOOK ATTACHMENT
RPI Part #RPA624

- 3-5/8" lg
- Hook: 1-1/8" wide with a .40" wide opening

Fits: Both Snakes (Metal Snake requires Adapter - RPI Part #RPA631)

PULLING EYE RING
RPI Part #RPA626

- 3/4" dia. pulling ring
- 5/16" dia. body

Fits: Both Snakes (Metal Snake requires Adapter - RPI Part #RPA631)

MAGNET ATTACHMENT
RPI Part #RPA622

- 15/32" dia. magnet tip
- Fits:** Both Snakes (Metal Snake requires Adapter - RPI Part #RPA631)

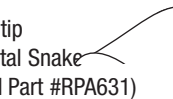

ACCESSORY POUCH
RPI Part #RPP634

- 5" w x 4" h
- 600 Denier Polyester
- Velcro® belt-loop flap

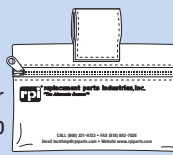

ADAPTER
RPI Part #RPA631



- Allows a step-up for use with Plastic Snake attachments (Hook Attachment, Pulling Eye Ring, and Magnet Attachment)
- Fits:** Metal Snake

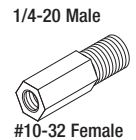

BULLET TIP (1/4" dia.)
RPI Part #RPA633



- 1/4" dia. body with 3/16" dia. hole
- Fits:** Metal Snake

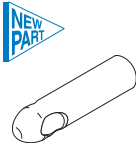

FIBER-OPTIC PULLER (1/4" dia.)
RPI Part #RPA630



- Includes (1) #6-32 x 3/32" lg. set screw to lock fiber-optic tube in place
 - 1/4" dia. Bullet Tip
 - 1-1/8" lg
- Fits:** Metal Snake

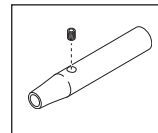

CONNECTOR (METAL SNAKE)
RPI Part #RPA632



- Allows two Metal Snakes to be connected for a 24' reach
- Fits:** Metal Snake

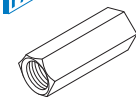

INFANT INCUBATORS

AIR SHIELDS • HILL-ROM • DRAGER

Isolette® C-86	200-201
Isolette® C-100	202-204
Isolette® C-100QT	202-204
Isolette® C-200	202-204
Isolette® C-200QT	202-204
Isolette® C-300	202-204
Isolette® C-400QT	202-204
Isolette® C-450QT	202-204
Isolette® C-500QT	202-204
Isolette® C-500QT Model XL	202-204
Isolette® C-550QT	202-204
Isolette® C-550QT Model XL	202-204
Isolette® C2000	206-209

GE • OHMEDA

Giraffe® Exam Light	217
Giraffe® Incubator	212-217
Giraffe® OmniBed®	212-217

OHIO MEDICAL • OHMEDA • GE

190	210
190A	210
Care Plus® 1000	210
Care Plus® 2000	210
Care Plus® 3000	210
Care Plus® 4000	210
General Care (GC)	210
Infant Care (IC)	210

INFANT WARMERS

AIR SHIELDS • HILL-ROM • DRAGER

7810 (Radiant Warmer)	301
7820 (Radiant Warmer)	301
7830 (Radiant Warmer)	301
7840 (Radiant Warmer)	301
ICS	300
IICS (PM 78-1)	301
Resuscitaire® RW82-1	302
Versalet® 7700	302-303

OHIO MEDICAL • OHMEDA • GE

Infant Warmer Systems (IWS) 2001	304
Infant Warmer Systems (IWS) 3000	304
Infant Warmer Systems (IWS) 3050	304
Infant Warmer Systems (IWS) 3100	304
Infant Warmer Systems (IWS) 3150	304
Infant Warmer Systems (IWS) 3300 (Panda®)	304
Infant Warmer Systems (IWS) 3400	304
Infant Warmer Systems (IWS) 3500	304
Infant Warmer Systems (IWS) 4000	304
Infant Warmer Systems (IWS) 4300	304
Infant Warmer Systems (IWS) 4400	304
Infant Warmer Systems (IWS) 5000	304

(continued)

PHOTOTHERAPY LIGHTS

AIR SHIELDS • HILL-ROM • DRAGER

IICS Phototherapy System 7850	400
PT1400	400
PT1400-1	400
PT1400-2	400
PT1400-2E	400
PT533	400
PTM-78-2	400

GE • OHMEDA

Biliblanket Plus	400
Biliblanket Plus High Output	400
Giraffe® Spot PT Lite	400

RPI Part #AIS034
OEM Part #17 806 27

LIGHT SOCKET

- 120VAC
- Accommodates standard NE51 bulb
- 9/16-27 lens threads
- 11/16-27 mounting threads
- Includes mounting hardware
- 1/4" tabs

Fits: Power Unit Panel
Model: C-86

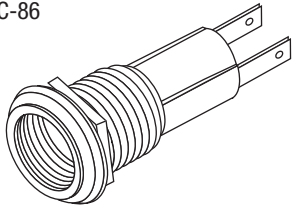

RPI Part #AMB028
OEM Part #17 800 30

LIGHT BULB

- Standard NE51 bulb (Neon)
- T-3-1/4 mini bayonet
- 120 VAC, .3 ma.

Fits: Light Socket
Model: C-86

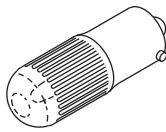

RPI Part #AIC035
OEM Part #17 802 60

LENS CAP (RED)

- 5/8" OD
- 9/16-27 thread

Fits: Light Socket
Model: C-86

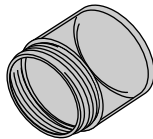

RPI Part #AIC036
OEM Part #17 804 00

LENS CAP (WHITE)

- 5/8" OD
- 9/16-27 thread

Fits: Light Socket
Model: C-86

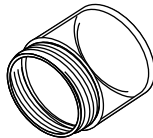

RPI Part #AIC037
OEM Part #17 802 30

LENS CAP (AMBER)

- 5/8" OD
- 9/16-27 thread

Fits: Light Socket
Model: C-86

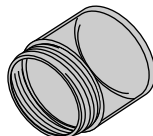

RPI Part #AIK005
OEM Part #68 905 72

MOTOR KIT- RPI "GREY" (NEW STYLE)

- 115VAC; 50/60 Hz., 1500 RPM
- This new style motor has a "grey" colored base
- Includes: Impeller (RPI Part #AI1006) & Motor Capacitor (RPI Part #AIC058)

Fits: Chassis Controller
Model: C-86

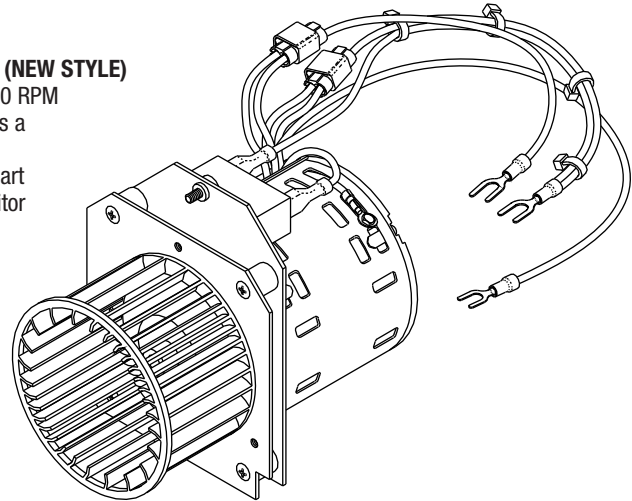

MOTOR KIT (220/240VAC; 1200 RPM)
TO FIT MODEL C86 IS ALSO AVAILABLE.
ASK FOR RPI PART #AIK009
(OEM PART #26 925 73)

RPI Part #AI1006
OEM Part #68 205 46

IMPELLER

Fits: Motor Shaft
Model: C-86

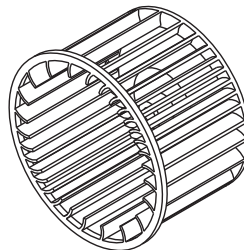

RPI Part #AIM021
OEM Part #17 776 59

PANEL METER

- 120V
- Range: 0, 1/4, 1/2, 3/4, Full
- Includes mounting bracket

Fits: Controller Front Panel
Model: C-86

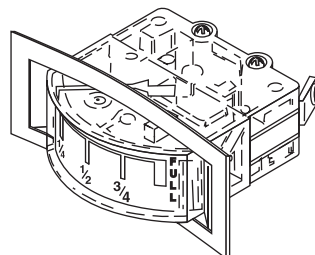

RPI Part #AIC058
OEM Part # (No OEM Part # Available)

MOTOR CAPACITOR

- 6 MFD; 250VAC; 50/60 Hz.
 - Matchbox style
- Fits:** Base Plate / RPI "new" style motors **only** – (RPI Part #'s AIK005 & AIK009) with "grey" colored case
Model: C-86

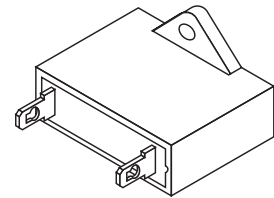

RPI Part #AIC059
OEM Part # (No OEM Part # Available)

MOTOR CAPACITOR

- 2.5 MFD; 400VAC; 60 Hz.
 - Matchbox style
- Fits:** Base Plate / RPI "old" style motors **only** – (RPI Part #'s AIK005 & AIK009) with "black" colored case
Model: C-86

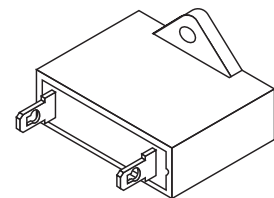

Infant Incubators

Model: Isolette® C-86 (Continued)

RPI Part #AIP063
OEM Part #17 575 14

SKIN TEMPERATURE PROBE (REUSABLE)

- 1/4" stereo phono plug
- Fits:** Controller
- Model:** C-86

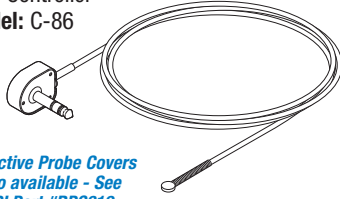

Reflective Probe Covers also available - See RPI Part #RPC619

RPI Part #RPC619
OEM Part #MU06944 & 68 209 48

REFLECTIVE PROBE COVER

- 100 per package
- Single use only
- Metalized Mylar with PSA backing; Latex Free
- Fits:** Skin Temperature Probe
- Models:** All Infant Warmer and Incubator Skin Temperature Probes



RPI Part #AIT011
OEM Part #26 928 71

THERMOSTAT (101.5°F)

- N.O.; Closes @ 101.5°F (38.61°C)
- Fits:** Thermostat Capsule
- Model:** C-86

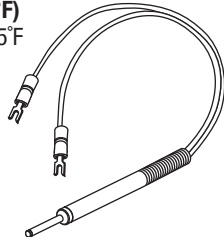

RPI Part #AIT012
OEM Part #26 928 72

THERMOSTAT (103°F)

- N.O.; Closes @ 103°F (39.44°C)
- Fits:** Thermostat Capsule
- Model:** C-86

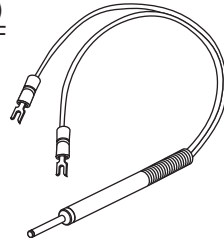

RPI Part #AIT086
OEM Part #26 681 00

RIGHT ANGLE THERMOMETER

- Graduated in Celsius 18° to 40°
- Graduated in Fahrenheit 60° to 105°
- Includes: (2) Nylon® Mounting Ring
- Fits:** Isolette Hood
- Model:** C-86

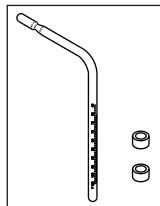

RPI Part #AIF024
OEM Part #MU03891 & 26 945 70

MICRO FILTER

- 4 per package
- ~6" x 24"
- Synthetic media - contains *no* glass fibers
- Latex free
- Fits:** Shell and Deck Assembly
- Model:** C-86

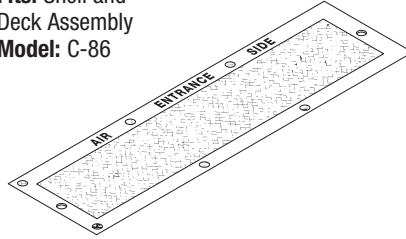

RPI Part #AIF082
OEM Part #MU06662 & 68 126 40

MICRO FILTER (DEW-ETTE®)

- 4 per package
- ~6" x 24"
- Synthetic media - contains *no* glass fibers
- Latex free
- Fits:** Shell and Deck Assembly
- Model:** C-86

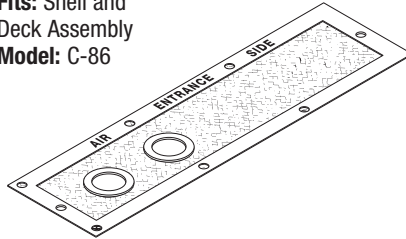

RPI Part #AIG015
OEM Part #MU01395 & 12 216 00

HOOD GASKET

- ~16" x 33.50"
- Material: Grey silicone rubber
- Fits:** Shell and Deck Assembly
- Model:** C-86

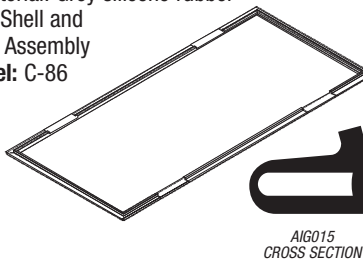

RPI Part #AIG019
OEM Part #26 630 11

ACCESS PANEL GASKET

- ~10.25" x 27"
- Material: Grey PVC
- Fits:** Access Panel
- Model:** C-86

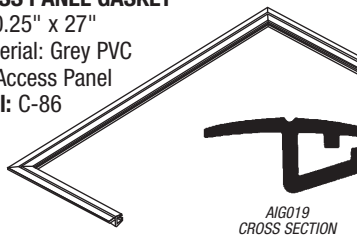

RPI Part #AIK160
OEM Part #MU08534 & 68 902 96

PAWL LATCH KIT

- Includes all parts as shown
- Fits:** Hood Assembly
- Model:** C-86

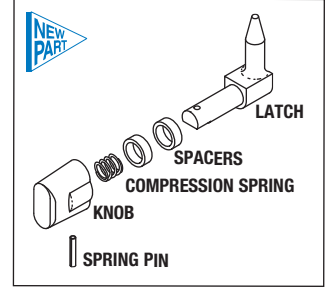

RPI Part #AIG025
OEM Part #26 654 00

ACCESS DOOR GASKET

- ~6.13" OD
- Soft flexible PVC - grey
- Fits:** Access Panel
- Model:** C-86

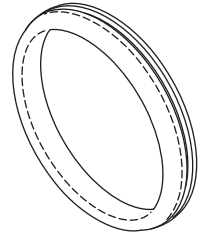

RPI Part #AID001
OEM Part #MU03817 & 26 650 00

ACCESS DOOR

- ~6.00" OD
- Clear
- Fits:** Hood
- Model:** C-86

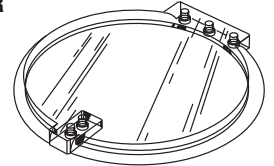

RPI Part #AIG017
OEM Part #MU03784 & 26 501 00

THERMOSTAT PLUG GASKET

- ~2.60" OD
- Sponge rubber
- Fits:** Thermostat Plug
- Model:** C-86

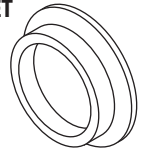

RPI Part #AIG018
OEM Part #MU03785 & 26 503 00

POWER PACK GASKET

- ~3.75"/5.50" x 12"
- Sponge rubber
- Fits:** Heater and Stiffener Plate
- Model:** C-86

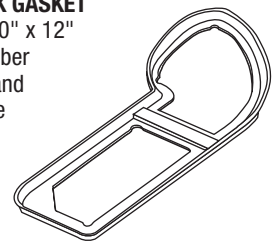

Cross section illustrations are actual size. Where practical, cut old part to match with cross section illustration.

Models: Isolette® C-100, C-100QT, C-200, C-200QT, C-300, C-400QT, C-450QT, C-500QT, C-500QT model XL, C-550QT & C-550QT model XL

RPI Part #AID001
OEM Part #MU03817 & 26 650 00

ACCESS DOOR

- ~6.00" OD; Clear
- Fits:** Access Panel and Hood (Model C-100/200); and, End and Front Door (Model C-300)
- Models:** C-100, C-200 & C-300

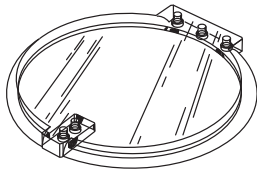

RPI Part #AIG016
OEM Part #MU06536 & 68 120 00

ACCESS DOOR GASKET

- ~6.17" OD
- Soft flexible white PVC
- Fits:** Hood Assembly
- Models:** C-100, C-200 & C-300

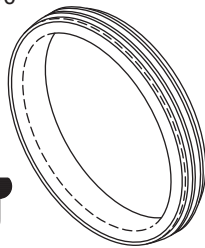

AIG016
CROSS SECTION

RPI Part #AIG027
OEM Part #MU06538 & 68 120 01

ACCESS DOOR GASKET

- ~6.94" OD
- Soft flexible white PVC
- Fits:** Access Panel
- Models:** C-100QT, C-200QT, C-400QT, C-450QT, C-500QT, C-500QT model XL, C-550QT & C-550QT model XL

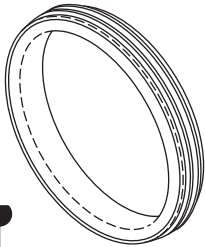

AIG027
CROSS SECTION

RPI Part #AIG028
OEM Part #MU03891 & 68 512 10

SEALING STRIP

- ~33.50" lg.; White PVC
- Fits:** Access Panel
- Models:** C-100QT, C-200QT, C-400QT, C-450QT, C-500QT & C-500QT model XL

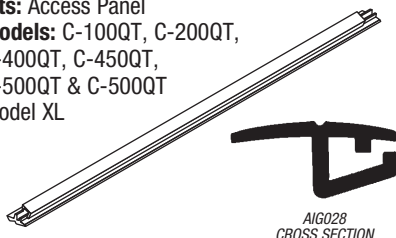

AIG028
CROSS SECTION

RPI Part #AIK160
OEM Part #MU08534 & 68 902 96

PAWL LATCH KIT

- Includes all parts as shown
- Fits:** Hood Assembly
- Models:** C-100, C-100QT, C-200, C-200QT, C-400QT, C-450QT, C-500QT, C-500QT model XL, C-550QT & C-550QT model XL

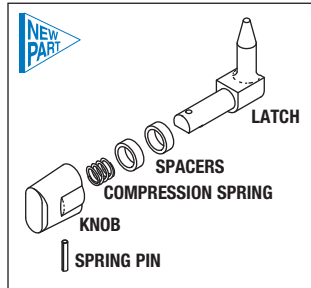

RPI Part #AIK061
OEM Part #MU10688 & 68 156 63

LARGE RETAINER KNOB

- ~.91" OD x .75" lg.
- Fits:** Access panel
- Models:** C-100QT, C-200QT, C-400QT & C-450QT

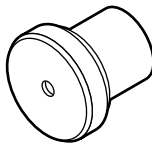

RPI Part #AIK062
OEM Part #MU06809 & 68 156 62

SMALL RETAINER KNOB

- ~.75" OD x .75" lg.
- Fits:** Access Panel
- Models:** C-100QT, C-200QT, C-400QT & C-450QT



RPI Part #RPC260
OEM Part #17 AZ 100

HOSPITAL GRADE POWER CORD

- 10 ft
- 14/3 SJT, 15A@125V
- Models:** C-100, C-100QT, C-200, C-200QT, C-300, C-400QT, C-450QT, C-500QT, C-500QT model XL, C-550QT & C-550QT model XL

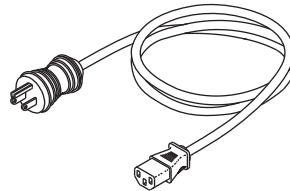

Cross section illustrations are actual size. Where practical, cut old part to match with cross section illustration.

RPI Part #AIH143
OEM Part #MU08163 (Pivot Hinge Only), 68 510 05 (Pivot Hinge Only) & 83 300 08 (Pivot Hinge Only)

PIVOT HINGE (ACCESS DOOR)

- Includes all parts as shown
- Fits:** Hood Assembly
- Models:** C-100QT, C-200QT, C-400QT, C-450QT, C-500QT, C-500QT model XL, C-550QT & C-550QT model XL

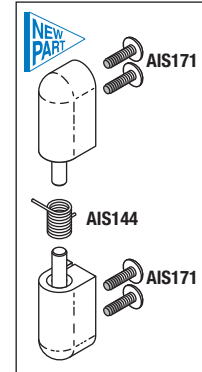

RPI Part #AIS144
OEM Part #MU08164 & 68 510 10

SPRING (TORSION)

- Material: Stainless steel
- .270" OD x .360" lg. x .030" dia. wire
- Also Included in: Pivot Hinge (Access Door) (RPI Part #AIH143)
- Fits:** Access Door Pivot Hinge
- Models:** C-100QT, C-200QT, C-400QT, C-450QT, C-500QT, C-500QT model XL, C-550QT & C-550QT model XL



RPI Part #AIS171
OEM Part #MU15131 & 99 023 64

SCREW (#6-32 x 7/16)

- 4 per package
- Material: Stainless steel supplied with pre-applied thread locker
- Size: #6-32 x 7/16" lg. Phillips Truss Head Screw
- Also included in: Pivot Hinge (Access Door) (RPI Part #AIH143)
- Models:** C-100QT, C-200QT, C-400QT, C-450QT, C-500QT, C-500QT model XL, C-550QT & C-550QT model XL

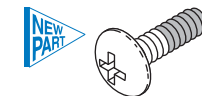

RPI Part #AIG020
OEM Part #MU12609 & 83 200 20

ACCESS GROMMET

- Material: Translucent thermoplastic rubber
- Fits:** Hood Assembly
- Models:** C-100, C-100QT, C-200, C-200QT, C-300, C-400QT, C-450QT, C-500QT, C-500QT model XL, C-550QT & C-550QT model XL

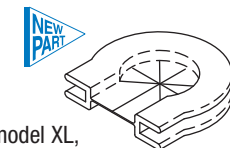

Infant Incubators

Models: Isolette® C-100, C-100QT, C-200, C-200QT, C-300, C-400QT, C-450QT, C-500QT, C-500QT model XL, C-550QT & C-550QT model XL (Continued)

RPI Part #AIP080
OEM Part #MU06933 & 68 209 20

SKIN TEMPERATURE PROBE (DISPOSABLE)

- Includes (10) probes and (10) pieces) Reflective Probe Cover (RPI Part #RPC619)
- Single use only
- 3 pin din connector

Fits: Controller

Models: C-100, C-100QT, C-450QT & C-550QT

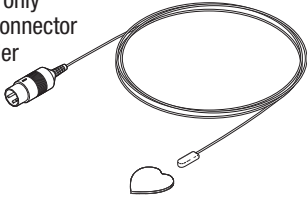

ALSO AVAILABLE BY THE CASE
RPI Part #AIP101 - 100/CASE
OEM Part #68 209 30 / MU6935

RPI Part #AIP064
OEM Part #MU06951 & 68 209 70

SKIN TEMPERATURE PROBE (REUSABLE)

- 3 pin din connector

Fits: Controller

Models: C-100, C-100QT, C-450QT & C-550QT

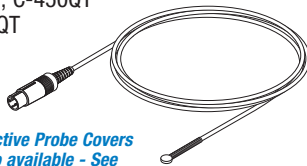

Reflective Probe Covers also available - See RPI Part #RPC619

RPI Part #RPC619
OEM Part #MU06944 & 68 209 48

REFLECTIVE PROBE COVER

- 100 per package
- Single use only
- Metalized Mylar with PSA backing; Latex Free

Fits: Skin Temperature Probe

Models: All Infant Warmer and Incubator Skin Temperature Probes



RPI Part #AIP070
OEM Part #MU06955 & 68 209 80

AIR AUXILIARY PROBE (GROUP 1)

- Loudspeaker type pin & blade connector
- Reuseable

Fits: Controller (Group 1)

Models: C-100, C-100QT, C-200, C-200QT, C-400QT & C-450QT



RPI Part #AIP141
OEM Part #MU06956 & 68 209 81

AIR AUXILIARY PROBE (GROUP 2)

- Reuseable

Fits: Controller (Group 2)

Models: C-400QT, C-450QT, C-500QT, C-500QT model XL, C-550QT & C-550QT model XL

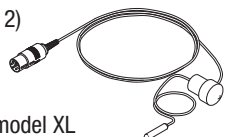

RPI Part #AIF024
OEM Part #MU03891 & 26 945 70

MICRO FILTER

- 4 per package
- ~6" x 24"
- Synthetic media - contains *no* glass fibers
- Latex free

Fits: Shell and Deck Assembly

Models: C-100, C-100QT, C-200, C-200QT, C-400QT, C-450QT, C-500QT, C-500QT model XL, C-550QT & C-550QT model XL

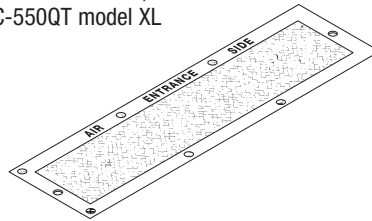

RPI Part #AIF082
OEM Part #MU06662 & 68 126 40

MICRO FILTER (DEW-ETTE®)

- 4 per package
- ~6" x 24"
- Synthetic media - contains *no* glass fibers
- Latex free

Fits: Shell and Deck Assembly

Models: C-100, C-100QT, C-200, C-200QT, C-400QT, C-450QT, C-500QT, C-500QT Model XL, C-550QT, C-550QT Model XL with Dew-ette® option

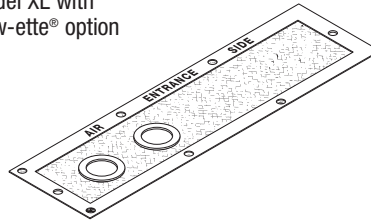

RPI Part #AIG015
OEM Part #MU01395 & 12 216 00

HOOD GASKET

- ~16" x 33.50"
- Material: Grey silicone rubber

Fits: Shell and Deck Assembly

Models: C-100, C-100QT, C-200, C-200QT, C-400QT, C-450QT, C-500QT & C-550QT model XL

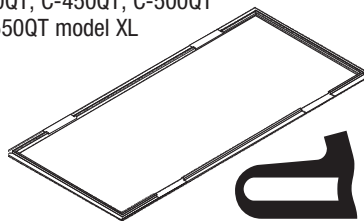

Cross section illustrations are actual size. Where practical, cut old part to match with cross section illustration.

RPI Part #AIS060
OEM Part #MU06827 & 68 157 56

"QT" HEAT SHIELD

- Clear

Fits: Panel Assembly Wall

Models: C-100QT, C-200QT, C-400QT & C-450QT

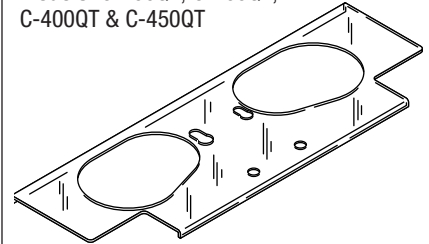

RPI Part #AIS047
OEM Part #MU03291 & 17 682 63

ROCKER SWITCH

- DPST
- 22A @ 125VAC; 16A @ 250VAC
- .250" tabs
- Color: Black

Fits: Basic Assembly

Model: C-300

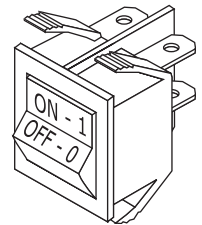

RPI Part #AIK068
OEM Part #MU02876 & 17 061 89

INSTRUMENT KNOB

- Size: ~1.13" OD; Fits .250" dia. shaft
- Color: Black
- Includes installed set screw

Fits: Controller Front Panel

Models: C-100, C-100QT, C-200 & C-200QT

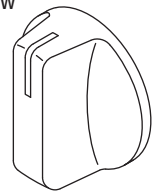

RPI Part #AIS067
OEM Part #MU06961 & 68 210 75

RESET SWITCH ASSEMBLY

- SPST
- Normally Open
- 0.5A, 125VAC
- ~ 6" lg. wires
- Red button

Fits: Controller Front Panel

Models: C-100, C-100QT, C-200 & C-200QT

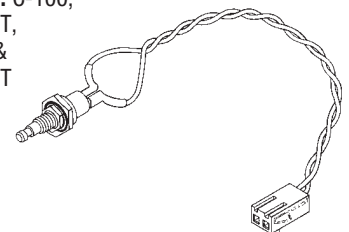

Models: Isolette® C-100, C-100QT, C-200, C-200QT, C-300, C-400QT, C-450QT, C-500QT, C-500QT model XL, C-550QT & C-550QT model XL (Continued)

RPI Part #AIK007

OEM Part #MU08632 & 68 905 70

MOTOR KIT - RPI "GREY" (NEW STYLE)

- 115VAC; 50/60 Hz., 1500 RPM
- This new style motor has a "grey" colored base
- Includes: Impeller (RPI Part #AI1008) and Motor Capacitor (RPI Part #AIC058)

Fits: Chassis Controller

Models: C-100, C-100QT, C-200, & C-200QT

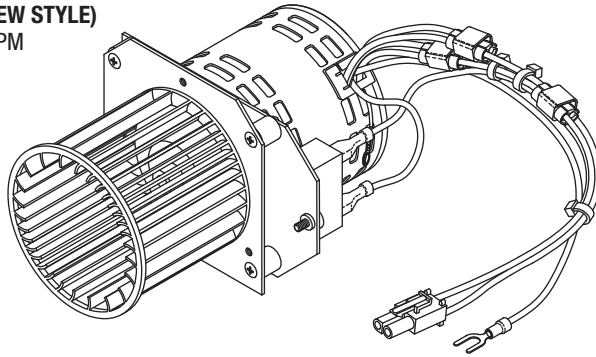

**MOTOR KIT (220/240VAC; 1200 RPM)
TO FIT MODELS C-100, C-100QT, C-200 & C-200QT IS ALSO AVAILABLE.
ASK FOR RPI PART #AIK010
(OEM Part #MU08633 & 68 905 71)**

RPI Part #AIC059

OEM Part # (No OEM Part # Available)

MOTOR CAPACITOR

- 2.5 MFD; 400VAC; 60 Hz.
- Matchbox style

Fits: RPI "old" style motors only – (RPI Part #'s AIK007 & AIK010) with "black" colored case

Models: C-100, C-100QT, C-200 & C-200QT

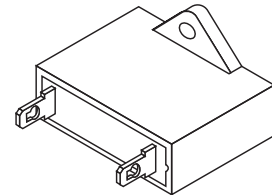

RPI Part #AIG018

OEM Part #MU03785 & 26 503 00

POWER PACK GASKET

- ~3.75"/5.50" x 12"
- Sponge rubber

Fits: Heater and Stiffener Plate

Models: C-100, C-100QT, C-200, C-200QT, C-400QT, C-450QT, C-500QT, C-500QT model XL, C-550QT & C-550QT model XL

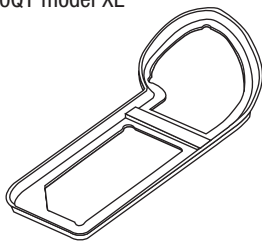

RPI Part #AI1008

OEM Part #MU06909 & 68 205 45

IMPELLER

Fits: Motor Shaft

Models: C-100, C-100QT, C-200 & C-200QT

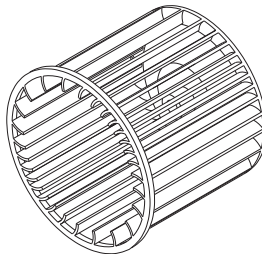

RPI Part #AIC058

OEM Part # (No OEM Part # Available)

MOTOR CAPACITOR

- 6 MFD; 250VAC; 50/60 Hz.
- Matchbox style

Fits: RPI "new" style motors only – (RPI Part #'s AIK007 & AIK010) with "grey" colored case

Models: C-100, C-100QT, C-200 & C-200QT

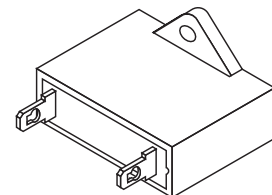

RPI Part #AIG017

OEM Part #MU03784 & 26 501 00

THERMOSTAT PLUG GASKET

- ~2.60" OD
- Sponge rubber

Fits: Thermostat Plug

Models: C-100, C-100QT, C-200, C-200QT, C-400QT, C-450QT, C-500QT, C-500QT model XL, C-550QT & C-550QT model XL

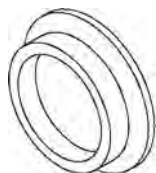

RPI Part #AIH069

OEM Part #MU06918 & 68 208 25

HEATER

- 377W, 120VAC, ~40Ω

Fits: Chassis Controller

Models: C-100, C-100QT, C-200, C-200QT, C-400QT & C-450QT

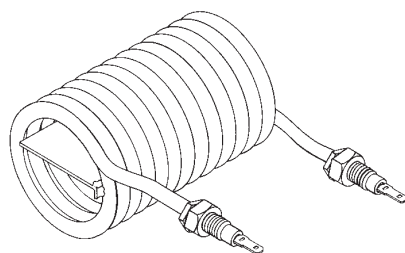

RPI Part #AIR013

OEM Part #MU08571, MU08572, 17 652 78, 68 903 83 & 68 903 84

RELAY

- Contacts: 10A @ 24-280VAC
- Input: 3-32VDC
- Size: ~2.25" L x 1.75" W x .78" H
- Includes built-in LED Input Status Indicator

Fits: Controller

Models: C-100, C-100QT, C-200 & C-200QT

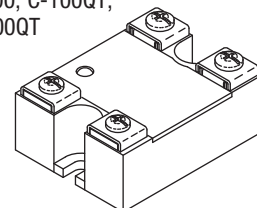

RPI Part #AIF140
OEM Part #MU12504 & 83 101 30

MICRO FILTER

- 4 per package
- ~3" x 5-1/2"
- Synthetic media - contains *no* glass fibers
- Latex free

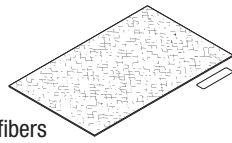

Includes installation date label

Fits: Filter Housing
Model: C2000

RPI Part #AIN169
OEM Part #MU15420 (1 Pc only) & 99 105 06 (1 Pc only)



WING NUT (#6-32)

- 6 per package
- Material: Stainless steel



Fits: Controller
Model: C2000

RPI Part #AIP133
OEM Part #MU12551 & 83 104 15

SKIN TEMPERATURE PROBE (DISPOSABLE)

- Includes (10) probes and (10) pieces Reflective Probe Cover (RPI Part #RPC619)
- Single use only
- 6 pin connector

Fits: Controller
Model: C2000

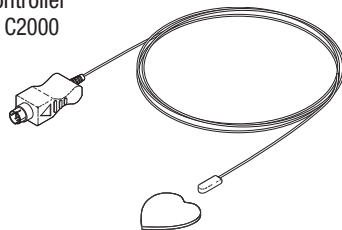

ALSO AVAILABLE BY THE CASE
RPI Part #AIP134 - 100/CASE

RPI Part #AIP135
OEM Part #MU12533 & 83 102 41

SKIN TEMPERATURE PROBE (REUSABLE)

- 6 pin connector

Fits: Controller
Model: C2000

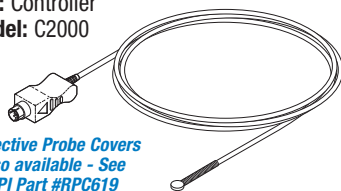

Reflective Probe Covers also available - See RPI Part #RPC619

RPI Part #RPC619
OEM Part #MU06944 & 68 209 48

REFLECTIVE PROBE COVER

- 100 per package
- Single use only
- Metalized Mylar with PSA backing; Latex Free



Fits: Skin Temperature Probe
Models: All Infant Warmer and Incubator Skin Temperature Probes

RPI Part #AIP165
OEM Part #MU12397 (Overlay Only) & 83 020 67 (Overlay Only)



FRONT PANEL ASSEMBLY

- Overlay mounted to sheet metal frame
- Includes all parts as shown

Fits: Controller
Model: C2000

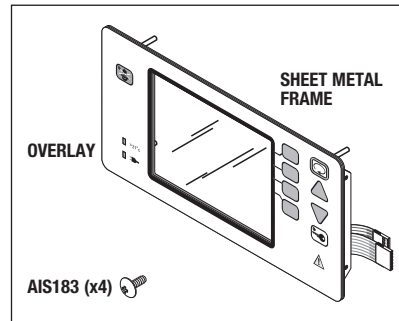

RPI Part #AIS183
OEM Part #MU15067 & 99 010 56



SCREW (#4-40 x 1/4)

- 4 per package
- Material: Stainless steel
- Size: #4-40 x 1/4" lg. Phillips Truss Head Screw



Fits: Front Panel Assembly
Model: C2000

RPI Part #AIF158
OEM Part #MU12409 (Fan Only) & 83 020 91 (Fan Only)



FAN ASSY (CONTROLLER)

- Size: 1.575" x 1.575" x .413" fan housing
- 10.8 to 13.2 VDC; 4200 RPM
- Includes all parts as shown

Fits: Controller
Model: C2000

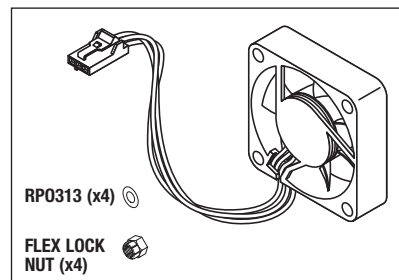

RPI Part #AIA159
OEM Part #MU12411 & 83 020 93



POWER SWITCH ASSEMBLY

- Switch: 8A @ 125VAC; DPDT

Fits: Controller
Model: C2000

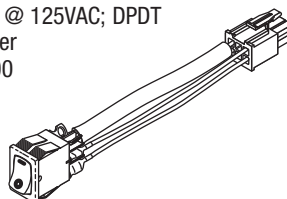

RPI Part #AIC156
OEM Part #MU12287 (Cable Only) & 83 005 30 (Cable Only)



SENSOR MODULE CABLE ASSY

- Length: ~32"
- Includes all parts as shown

Fits: Sensor Module
Model: C2000

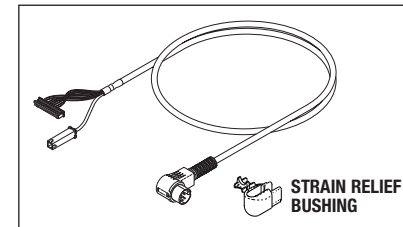

RPI Part #AIF157
OEM Part #MU12299 (Fan Only) & 83 005 46 (Fan Only)



FAN ASSY (SENSOR MODULE)

- Size: 1.575" x 1.575" x .413" fan housing
- 10.8 to 13.2 VDC; 4200 RPM
- Includes all parts as shown

Fits: Sensor Module
Model: C2000

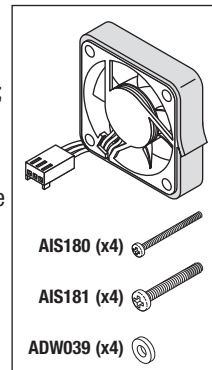

RPI Part #ADW039
OEM Part #MU15510 & 99 121 22



FLAT WASHER (#6)

- 15 per package
- Material: Nylon®
- Size: .140" ID x .320" OD x .030" thk



Model: C2000

RPI Part #AIS180
OEM Part #MU15095 & 99 012 33



SCREW (#4-40 x 1)

- 4 per package
- Material: Stainless steel supplied with pre-applied thread locker
- Size: #4-40 x 1.0" lg. Phillips Pan Head Screw

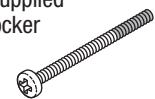

Model: C2000

RPI Part #AIS181
OEM Part #MU15153 & 99 024 98



SCREW (#6-32 x 15/16)

- 4 per package
- Material: Stainless steel supplied with pre-applied thread locker
- Size: #6-32 x 15/16" lg. Phillips Pan Head Screw

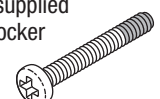

Model: C2000

Infant Incubators

Model: Isolette® C2000 (Continued)

RPI Part #AIH151
OEM Part #MU12601 (Hinge Only) & 83 200 11 (Hinge Only)

HINGE (HOOD) FRONT LEFT

- Includes all parts as shown
- Also available: Hinge (Access Panel) Front Left (RPI Part #AIH147) and Hinge Pin Kit (RPI Part #AIK167)

Fits: Hood Assembly
Model: C2000

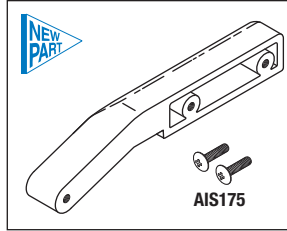

RPI Part #AIH150
OEM Part #MU12600 (Hinge Only) & 83 200 10 (Hinge Only)

HINGE (HOOD) FRONT RIGHT

- Includes all parts as shown
- Also available: Hinge (Access Panel) Front Right (RPI Part #AIH146) and Hinge Pin Kit (RPI Part #AIK167)

Fits: Hood Assembly
Model: C2000

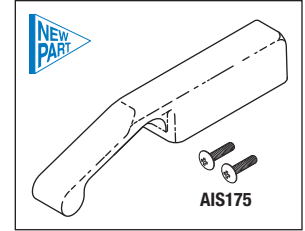

RPI Part #AIH153
OEM Part #MU12602 (Hinge Only) & 83 200 12 (Hinge Only)

HINGE (HOOD) REAR LEFT

- Includes all parts as shown
- Also available: Hinge (Access Panel) Rear Left (RPI Part #AIH149) and Hinge Pin Kit (RPI Part #AIK167)

Fits: Hood Assembly
Model: C2000

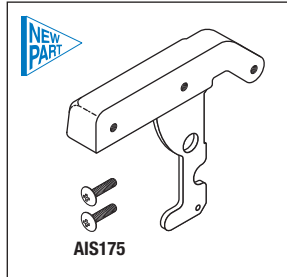

RPI Part #AIH152
OEM Part #MU12603 (Hinge Only) & 83 200 13 (Hinge Only)

HINGE (HOOD) REAR RIGHT

- Includes all parts as shown
- Also available: Hinge (Access Panel) Rear Right (RPI Part #AIH148) and Hinge Pin Kit (RPI Part #AIK167)

Fits: Hood Assembly
Model: C2000

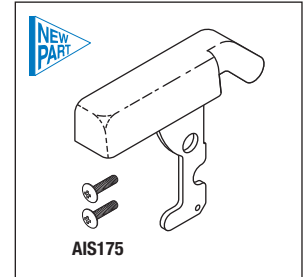

RPI Part #AIH149
OEM Part #MU12698 (Hinge Only) & 83 300 35 (Hinge Only)

HINGE (ACCESS PANEL) REAR LEFT

- Includes all parts as shown
- Also available: Hinge (Hood) Rear Left (RPI Part #AIH152) and Hinge Pin Kit (RPI Part #AIK167)

Fits: Access Panel
Model: C2000

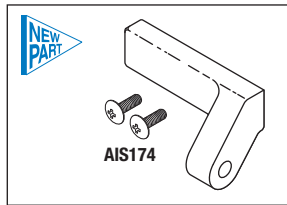

RPI Part #AIH148
OEM Part #MU12699 (Hinge Only) & 83 300 36 (Hinge Only)

HINGE (ACCESS PANEL) REAR RIGHT

- Includes all parts as shown
- Also available: Hinge (Hood) Rear Right (RPI Part #AIH153) and Hinge Pin Kit (RPI Part #AIK167)

Fits: Access Panel
Model: C2000

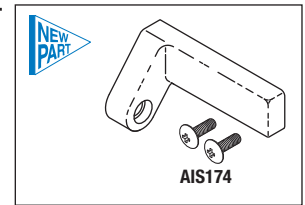

RPI Part #AIH147
OEM Part #MU12695 (Hinge Only) & 83 300 31 (Hinge Only)

HINGE (ACCESS PANEL) FRONT LEFT

- Includes all parts as shown
- Also available: Hinge (Hood) Front Left (RPI Part #AIH151) and Hinge Pin Kit (RPI Part #AIK167)

Fits: Access Panel
Model: C2000

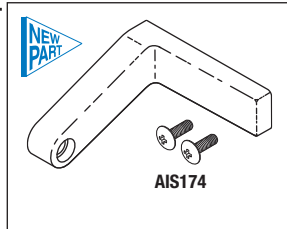

RPI Part #AIH146
OEM Part #MU12694 (Hinge Only) & 83 300 30 (Hinge Only)

HINGE (ACCESS PANEL) FRONT RIGHT

- Includes all parts as shown
- Also available: Hinge (Hood) Front Right (RPI Part #AIH150) and Hinge Pin Kit (RPI Part #AIK167)

Fits: Access Panel
Model: C2000

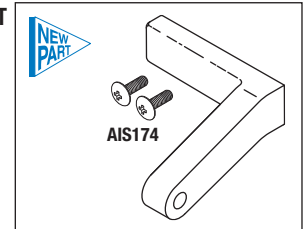

RPI Part #AIK167
OEM Part #MU15729 (Shoulder Screw Only) & 99 195 05 (Shoulder Screw Only)

HINGE PIN KIT

- Includes all parts as shown
- Fits:** Hood Assembly
Model: C2000

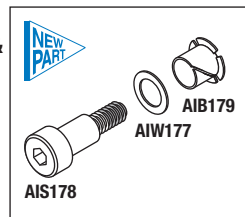

RPI Part #AIS178
OEM Part #MU15729 & 99 195 05

SHOULDER SCREW

- 2 per package
 - Material: Stainless steel supplied with pre-applied thread locker
 - Size: .250" dia. x .375" lg.; #10-24 Thread
- Model:** C2000

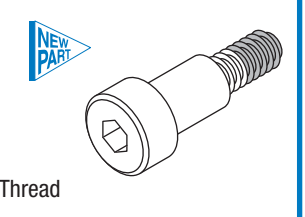

RPI Part #AIB179
OEM Part #MU12267 & 83 001 21

BEARING (FLANGED)

- 2 per package
 - Material: Nylon®
 - For .250" dia. shaft
- Model:** C2000

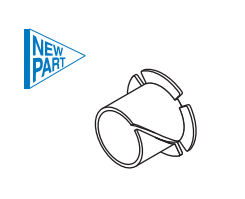

RPI Part #AIW177
OEM Part #MU15580 & 99 125 28

FLAT WASHER (1/4)

- 4 per package
 - Material: Nylon®
 - Size: .250" ID x .380" OD x .030" thk
- Model:** C2000

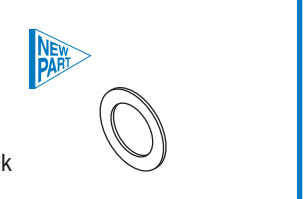

RPI Part #AIH143
OEM Part #MU08163 (Pivot Hinge Only),
68 510 05 (Pivot Hinge Only) &
83 300 08 (Pivot Hinge Only)

PIVOT HINGE (ACCESS DOOR)

- Includes all parts as shown
- Fits:** Hood Assembly
- Model:** C2000

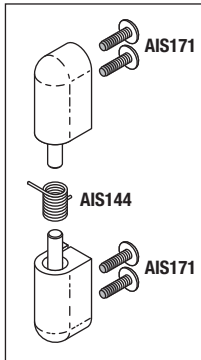

RPI Part #AIS144
OEM Part #MU08164 & 68 510 10

SPRING (TORSION)

- Material: Stainless steel
- .270" OD x .360" lg. x .030" dia. wire
- Also Included in: Pivot Hinge (Access Door) (RPI Part #AIH143)
- Fits:** Access Door Pivot Hinge
- Model:** C2000



RPI Part #AIS171
OEM Part #MU15131 & 99 023 64

SCREW (#6-32 x 7/16)

- 4 per package
- Material: Stainless steel supplied with pre-applied thread locker
- Size: #6-32 x 7/16" lg. Phillips Truss Head Screw
- Also included in: Pivot Hinge (Access Door) (RPI Part #AIH143)
- Model:** C2000

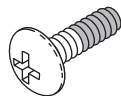

RPI Part #AIS175
OEM Part #MU15254 & 99 042 92

SCREW (#10-32 x 3/4)

- 2 per package
- Material: Stainless steel supplied with pre-applied thread locker
- Size: #10-32 x 3/4" lg. Phillips Truss Head Screw
- Also included in: Hinge (Hood) Front Right (RPI Part #AIH150), Hinge (Hood) Front Left (RPI Part #AIH151), Hinge (Hood) Rear Right (RPI Part #AIH152), Hinge (Hood) Rear Left (RPI Part #AIH153)
- Model:** C2000

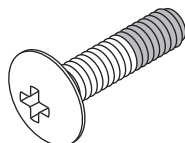

RPI Part #AIK160
OEM Part #MU08534 & 68 902 96

PAWL LATCH KIT

- Includes all parts as shown
- Fits:** Hood Assembly
- Model:** C2000

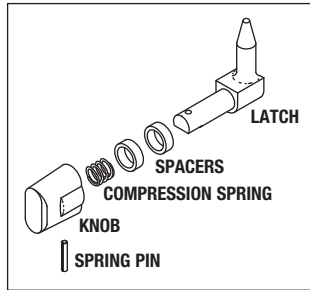

RPI Part #AIK161
OEM Part #MU13393 & 83 900 09

LATCH KIT (ACCESS DOOR)

- Includes all parts as shown
- Fits:** Hood Assembly
- Model:** C2000

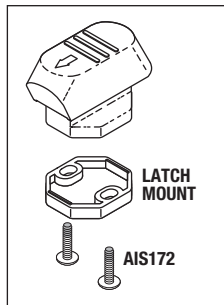

RPI Part #AIK162
OEM Part #MU12604 (Keeper Only) & 83 200 15 (Keeper Only)

KEEPER (ACCESS PNL LATCH)

- Includes all parts as shown
- Fits:** Hood Assembly
- Model:** C2000

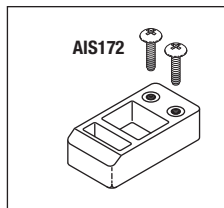

RPI Part #AIS172
OEM Part #MU15142 & 99 024 19

SCREW (#6-32 x 9/16)

- 2 per package
- Material: Stainless steel supplied with pre-applied thread locker
- Size: #6-32 x 9/16" lg. Phillips Truss Head Screw
- Also included in: Latch Kit (Access Door) (RPI Part #AIK161), Keeper (Access Pnl Latch) (RPI Part #AIK162) and Cable Clamp Kit (RPI Part #AIK163)
- Model:** C2000

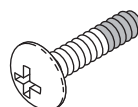

RPI Part #AIG020
OEM Part #MU12609 & 83 200 20

ACCESS GROMMET

- Material: Translucent thermoplastic rubber
- Fits:** Hood Assembly
- Model:** C2000

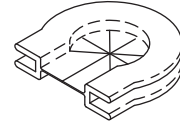

RPI Part #AIK163
OEM Part #MU11061 (Nylon Cable Clamp Only) & 81 020 20 (Nylon Cable Clamp Only)

CABLE CLAMP KIT

- Material: White Nylon® clamp
- Includes all parts as shown
- Fits:** Hood Assembly
- Model:** C2000

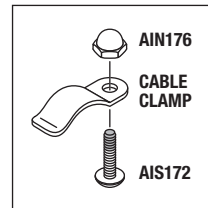

RPI Part #AIN176
OEM Part #MU15421 & 99 105 20

ACORN NUT (#6-32)

- 4 per package
- Material: Stainless steel
- Also included in: Cable Clamp Kit (RPI Part #AIK163)
- Model:** C2000



RPI Part #AIS174
OEM Part #MU15248 & 99 042 66

SCREW (#10-32 x 5/8)

- 2 per package
- Material: Stainless steel supplied with pre-applied thread locker
- Size: #10-32 x 5/8" lg. Phillips Truss Head Screw
- Also included in: Hinge (Access Panel) Front Right (RPI Part #AIH146), Hinge (Access Panel) Front Left (RPI Part #AIH147), Hinge (Access Panel) Rear Right (RPI Part #AIH148), Hinge (Access Panel) Rear Left (RPI Part #AIH149)
- Model:** C2000

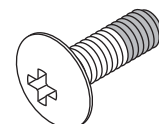

Infant Incubators

Model: Isolette® C2000 (Continued)

RPI Part #AIA154
OEM Part #MU12626 (Slide Only) & 83 200 45 (Slide Only)

SLIDE ASSY (SENSOR MODULE)

- Includes all parts as shown
- Fits:** Hood Assembly
- Model:** C2000

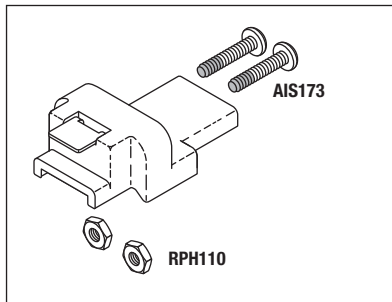

RPI Part #AIS173
OEM Part #MU15147 & 99 024 52

SCREW (#6-32 x 5/8)

- 2 per package
- Material: Stainless steel supplied with pre-applied thread locker
- Size: #6-32 x 5/8" Ig. Phillips Pan Head Screw
- Also included in: Slide Assy (Sensor Module) (RPI Part #AIA154)

Model: C2000

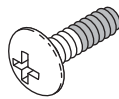

RPI Part #RPH110
OEM Part # (No OEM Part # Available)

HEX NUT (#6-32)

- 50 per package
- Material: Stainless steel
- Size: #6-32 Hex Nut
- Also included in: Hardware Kit (RPI Part #RPK402) and Slide Assy (Sensor Module) (RPI Part #AIA154)

Model: C2000



RPI Part #AIC155
OEM Part #MU13058 & 83 600 30

SCALE CABLE ASSEMBLY

- Length: ~39.5"
- Fits:** Weight Scale
- Model:** C2000

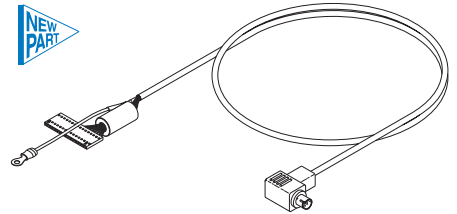

RPI Part #AIC142
OEM Part #MU12564 & 83 110 15

TUBING CAP

- 4 per package
- Material: White plastic
- Size: 1.00" OD
- Fits:** Mattress Tray Lift Bars
- Model:** C2000

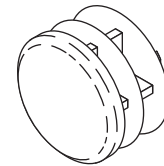

RPI Part #AIL145
OEM Part #MU12681 (Latch Only) & 83 300 09 (Latch Only)

LATCH (HEAT SHIELD)

- Includes all parts as shown
- Fits:** Hood Assembly
- Model:** C2000

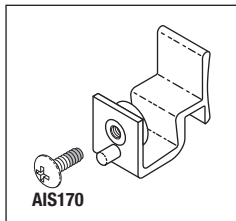

RPI Part #AIS170
OEM Part #MU15127 & 99 023 51

SCREW (#6-32 x 3/8)

- 2 per package
- Material: Stainless steel supplied with pre-applied thread locker
- Size: #6-32 x 3/8" Ig. Phillips Truss Head Screw
- Also included in: Latch (Heat Shield) (RPI Part #AIL145)

Model: C2000

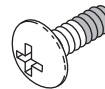

RPI Part #AIK164
OEM Part #MU07138 (Motor Mount Only) & 68 230 24 (Motor Mount Only)

MOTOR MOUNT KIT

- 4 per package
- Material: Rubber vibration mount, stainless steel hardware
- Includes all parts as shown

Fits: Chassis
Model: C2000

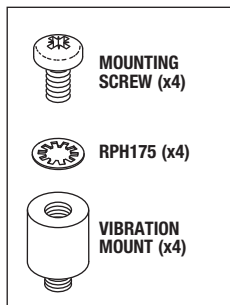

RPI Part #RPH175
OEM Part #MU15553 & 99 122 924

NO. 8 INTERNAL TOOTH WASHER

- 50 per package
- Size: #8
- Material: Stainless steel
- Type: Internal tooth lock washer
- Also included in: Lockwasher Kit (RPI Part #RPK413) and Motor Mount Kit (RPI Part #AIK164)

Model: C2000



RPI Part #AIS168
OEM Part #MU15296 (1 Pc only) & 99 055 96 (1 Pc only)

SCREW (1/4-20 x 1/2)

- 12 per package
- Material: Stainless steel supplied with pre-applied thread locker
- Size: 1/4-20 x 1/2" Ig. Phillips Truss Head Screw

Fits: Chassis
Model: C2000

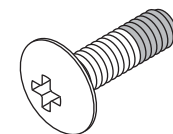

RPI Part #OMP006
OEM Part #6600-0208-700

SKIN TEMPERATURE PROBE (DISPOSABLE)

- Includes (10) probes and (10 pieces) Reflective Probe Cover (RPI Part #RPC619)
- Single use only
- 1/8" mono jack

Fits: Controller

Models: Care Plus 1000, 2000, 3000 & 4000, General Care (GC) & Infant Care (IC)

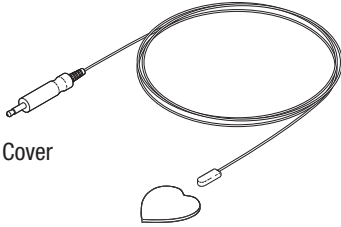

ALSO AVAILABLE BY THE CASE!

RPI Part #OMP007
OEM Part #6600-0196-700

SKIN TEMPERATURE PROBE (DISPOSABLE) - Case

- Includes: (50) probes and (50 pieces) Reflective Probe Cover (RPI Part #RPC619)

RPI Part #OMP008
OEM Part #6600-0628-700 & 0208-0697-700

SKIN TEMPERATURE PROBE (REUSABLE)

- 1/8" mono jack

Fits: Controller

Models: Care Plus 1000, 2000, 3000 & 4000, General Care (GC) & Infant Care (IC)

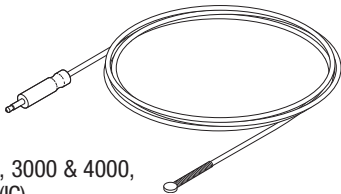

Reflective Probe Covers also available - See RPI Part #RPC619

RPI Part #RPC619
OEM Part #0203-1980-300

REFLECTIVE PROBE COVER

- 100 per package; Single use only
- Metalized Mylar with PSA backing; Latex Free

Fits: Skin Temperature Probe

Models: All Infant Warmer and Incubator Skin Temperature Probes



RPI Part #OMP012
OEM Part #208-0161-300

SKIN TEMPERATURE PROBE (REUSABLE)

- 1/4" mono plug

Fits: Controller

Models: 190/190A

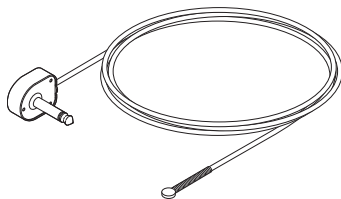

Reflective Probe Covers also available - See RPI Part #RPC619

RPI Part #RPC619
OEM Part #0203-1980-300

REFLECTIVE PROBE COVER

- 100 per package; Single use only
- Metalized Mylar with PSA backing; Latex Free

Fits: Skin Temperature Probe

Models: All Infant Warmer and Incubator Skin Temperature Probes



RPI Part #0MK040
OEM Part #6600-0048-850

CALIBRATION KIT

- Use to calibrate Humidity Sensor
- Solution usable for up to 1 year after mixing
- Includes: Vial with sodium chloride and rubber elbow

Fits: Humidity Sensor

Models: Care Plus 1000, 2000, 3000 & 4000

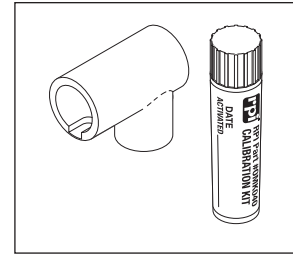

RPI Part #0MF013
OEM Part #0217-2871-600

AIR FILTER

- 5 per package; ~9" x 13-1/4"
- Synthetic media (Does not contain glass fibers)
- Latex free

Fits: Filter Housing

Models: General Care (GC) & Infant Care (IC)

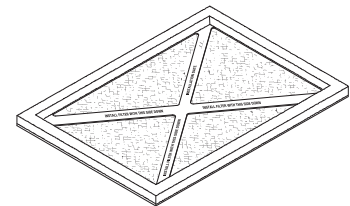

RPI Part #0MF016
OEM Part #6600-0105-300

MICRO FILTER

- ~6" x 11"
- Synthetic media (Does not contain glass fibers)
- Latex free

Fits: Filter Housing

Models: Care Plus 1000 & 2000

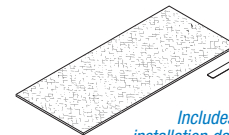

Includes installation date label

RPI Part #0MF014
OEM Part #6600-0043-800

MICRO FILTER

- ~6-3/4" x 11-5/8"
- Synthetic media (Does not contain glass fibers)
- Latex free

Fits: Filter Housing

Models: 190, 190A, Care Plus 3000 & 4000

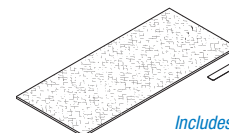

Includes installation date label

RPI Part #OMP009
OEM Part #6600-0873-700

SKIN TEMPERATURE PROBE (DISPOSABLE)

- Single use only
- 3 pin connector
- Includes: (10) probes and (10 pieces) Reflective Probe Cover (RPI Part #RPC619)

Fits: Probe Panel

Models: Giraffe OmniBed & Giraffe Incubator

ALSO AVAILABLE BY THE CASE!

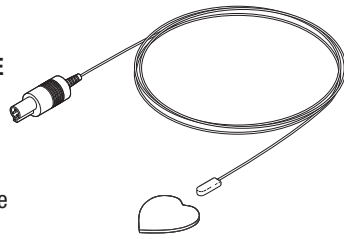

RPI Part #OMP010
OEM Part #6600-0874-700

SKIN TEMPERATURE PROBE (DISPOSABLE) - CASE of 50

- Includes: (50) probes and (50 pieces) Reflective Probe Cover (RPI Part #RPC619)

RPI Part #OMP011
OEM Part #6600-0875-700

SKIN TEMPERATURE PROBE (REUSABLE)

- 3 pin connector
- Also available: Reflective Probe Covers (RPI Part #RPC619)

Fits: Probe Panel

Models: Giraffe OmniBed & Giraffe Incubator

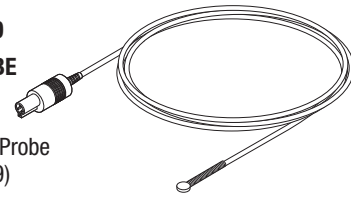

RPI Part #RPC619
OEM Part #0203-1980-300

REFLECTIVE PROBE COVER

- 100 per package; Single use only
- Metalized Mylar with PSA backing; Latex Free

Fits: Skin Temperature Probe

Models: All Infant Warmer and Incubator Skin Temperature Probes



RPI Part #OMF015
OEM Part #6600-0207-850

MICRO FILTER

- 10 per package
- 1-1/2" x 5-1/2"
- Synthetic media (Does not contain glass fibers); Latex free
- RPI Advantage! PM Sticker is included for recording date that Filter was replaced.

Fits: Filter Housing

Models: Giraffe OmniBed & Giraffe Incubator

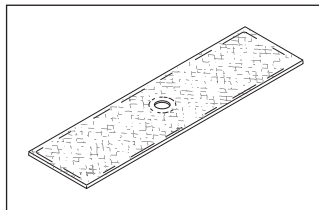

RPI Part #OMG017
OEM Part #6600-1248-500

CORNER GROMMET

- Material: Translucent thermoplastic rubber

Fits: End Panel

Models: Giraffe OmniBed & Giraffe Incubator

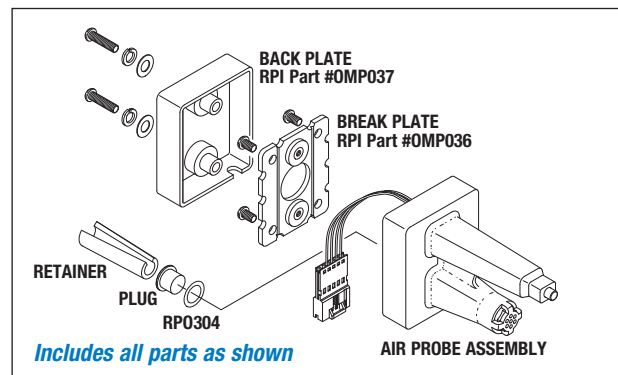
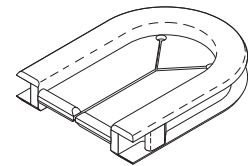

RPI Part #OMP018
OEM Part #6600-1512-700

COMPARTMENT AIR PROBE

- Also available: Humidity Sensor (RPI Part #OMS038)

Fits: Rear Wall Panel

Models: Giraffe OmniBed & Giraffe Incubator

RPI Part #OMP036
OEM Part #6600-1473-500 (Break Plate Only)/6600-0706-406 (Screw Only)

BREAK PLATE

- Includes all parts as shown
- Included in: Compartment Air Probe (RPI Part #OMP018)

Fits: Compartment Air Probe

Models: Giraffe OmniBed & Giraffe Incubator

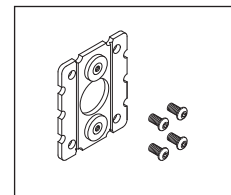

RPI Part #OMP037
OEM Part #6600-1474-500

BACK PLATE

- Includes all parts as shown
- Included in: Air Compartment Probe (RPI Part #OMP018)

Fits: Compartment Air Probe

Models: Giraffe OmniBed & Giraffe Incubator

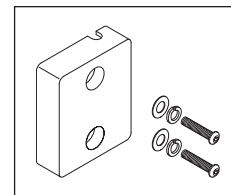

RPI Part #OMS038
OEM Part #6600-0784-700 (Sensor Only)/6600-0540-400 (O-ring Only)/6600-1475-500 (Retainer Only)

HUMIDITY SENSOR

- Includes all parts as shown
- Also available: Calibration Kit (RPI Part #OMK040) and Compartment Air Probe (RPI Part #OMP018)

Fits: Compartment Air Probe

Models: Giraffe OmniBed & Giraffe Incubator

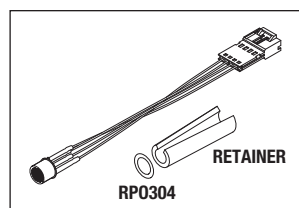

RPI Part #OMK040
OEM Part #6600-0048-850

CALIBRATION KIT

- Use to calibrate Humidity Sensor (RPI Part #OMS038)
- Solution usable for up to 1 year after mixing
- Includes: Vial with sodium chloride and rubber elbow

Fits: Humidity Sensor

Models: Giraffe OmniBed & Giraffe Incubator

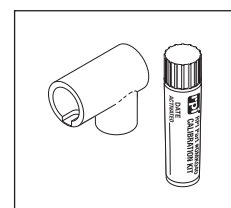

Infant Incubators

Models: Giraffe® Incubator & Giraffe® OmniBed®

Includes all parts as shown

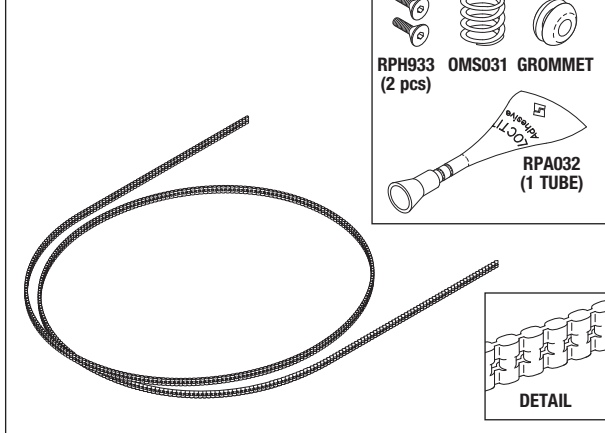

RPI Part #OMB030
OEM Part #6600-1372-500 (Lift Belt Only)/**6600-1071-400** (Belt Tensioner Spring Only)/**6600-1187-400** (Grommet Only)

LIFT BELT

- Length: 75"; Pitch: 0.1475"; Width: 0.23"
 - Material: Molded polyurethane with twin stainless steel cores
 - Also available: Belt Block Kit (RPI Part #OMK060), Arrow Clip (RPI Part #RPC902), and Buoyancy Spring Kit (Right) (RPI Part #OMK057)
- Fits:** Lift Rail Belt Channel (Right)
Models: Giraffe OmniBed

RPI Part #OMS031
OEM Part #6600-1071-400

BELT TENSIONER SPRING

- Size: .54"OD x .75" lg. x .06" wire
 - Material: Stainless steel
 - Included in: Lift Belt (RPI Part #OMB030)
- Fits:** Lift Belt/Lift Rail Channel
Models: Giraffe OmniBed



Includes all parts as shown

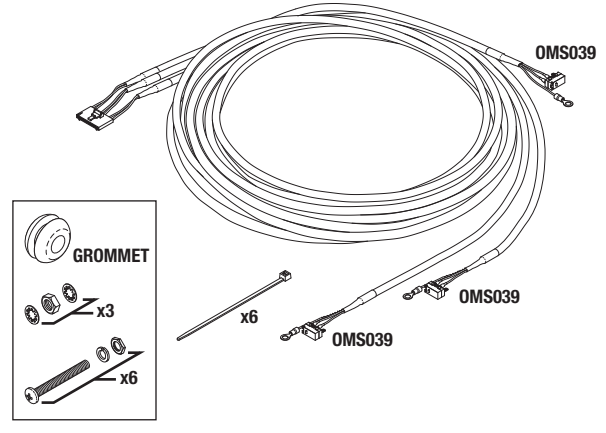

RPI Part #OMH032
OEM Part #6600-0718-700/6600-1187-400 (Grommet Only)

HOOD HARNESS

Fits: Lift Rail Cable Channel
Models: Giraffe OmniBed

RPI Part #OMS039
OEM Part #6600-0718-700 (Complete Hood Harness)/**6600-1187-400** (Grommet Only)

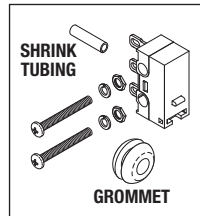

MICROSWITCH

- 0.1 A @ 48VAC; SPDT
 - Includes: Mounting hardware, shrink tubing, and heater door opening rod grommet
 - Included in: Hood Harness (RPI Part #OMH032)
 - Replace the complete Hood Harness (RPI Part #OMH032) or just replace the Microswitches, you decide - it's the RPI advantage!
- Fits:** Hood Harness/Lift Rail Channel
Models: Giraffe OmniBed

Includes all parts as shown

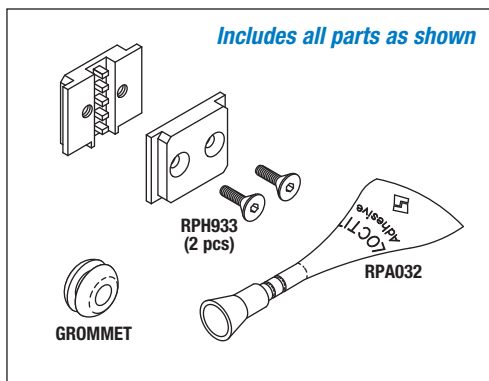

RPI Part #OMK060
OEM Part #6600-1357-500 (Belt Adjuster, Bottom only), **6600-1358-500** (Block Adjuster, Top only), **6600-1151-400** (Screw, M3 x 10 only) & **6600-1187-400** (Grommet only)

BELT BLOCK KIT

- Material: Brass
 - Includes: Belt Block Set, (2 pcs) Screw (M3 x 10) (RPI Part #RPH933), Grommet, and (1 Tube) Threadlocker 242 (RPI Part #RPA032)
 - Also available: Lift Belt (RPI Part #OMB030)
- Fits:** Lift Belt
Models: Giraffe OmniBed

RPI Part #RPA032
OEM Part #6600-1357-500 (Belt Adjuster, Bottom only), **6600-1358-500** (Block Adjuster, Top only) & **6600-1151-400** (Screw, M3 X 10 only)

THREADLOCKER 242

- 5 per package; .02 fl. oz. (.5ml) per tube
 - Prevents rust and corrosion
 - Removable adhesive by Loctite®
 - MSDS available on RPI website
- Fits:** Lift Belt
Models: Giraffe OmniBed

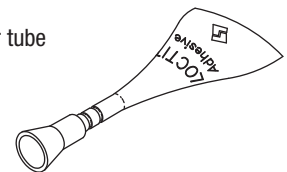

RPI Part #RPH933
OEM Part # (No OEM Part # Available)

SCREW (M3 x 10mm S/S Flat Hd. Allen) - 25/PKG

- Material: Stainless steel
- Fits:** Belt Block
Models: Giraffe Incubator & Giraffe OmniBed



RPI Part #RPC902
OEM Part #6600-1056-400

ARROW CLIP - 6/ PKG

- Hole dia.: .250"; Material: Nylon
 - Size: .50" dia. head x .57" lg.
- Fits:** Soffit
Models: Giraffe OmniBed



Includes all parts as shown

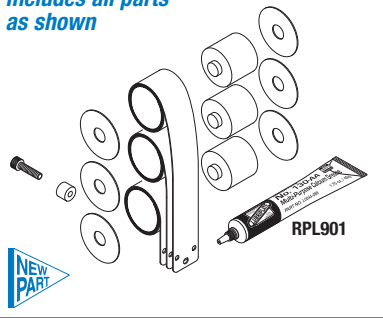

RPI Part #OMK058

OEM Part #6600-1708-500 (Delrin Washer only), **6600-1464-500** (Upper Buoyancy Spring only), **6600-1465-500** (Lower Buoyancy Spring only), **6600-1725-500** (Left Buoyancy Spring only), **6600-1103-400** (Spacer only), **6600-1152-400** (Screw only) & **6600-1317-500** (Spring Spool only)

BUOYANCY SPRING KIT (LEFT)

- Includes: Upper Buoyancy Spring, Lower Buoyancy Spring, Left Buoyancy Spring, Spacer, Screw (M5 x 20), (6) Delrin Washers, (3) Spring Spools and Lubriplate (130AA) (RPI Part #RPL901)

Fits: Left Upright

Models: Giraffe OmniBed



RPI Part #RPL901

OEM Part #0616-0203-300 (10 oz. Tube)

LUBRIPLATE® (130AA)

- 1.75 oz. resealable tube
- MSDS available on RPI website
- Included in: Buoyancy Spring Kit (Right) (RPI Part #OMK057) and Buoyancy Spring Kit (Left) (RPI Part #OMK058)

Models: Giraffe Incubator & Giraffe OmniBed

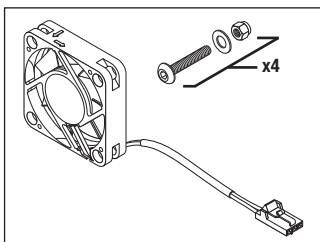

RPI Part #OMF024

OEM Part #6600-1523-700

COOLING FAN

- Size: 1.575" x 1.575" x .41" fan housing
- 6.0-13.8 VDC; 5800 RPM
- Includes: Mounting hardware

Fits: Heat Sink Vent

Models: Giraffe OmniBed & Giraffe Incubator

Includes all parts as shown

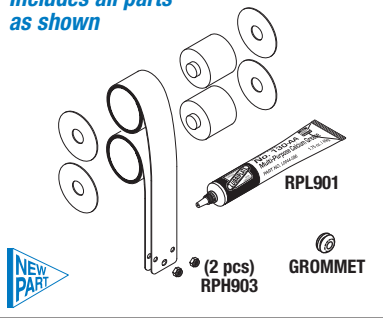

RPI Part #OMK057

OEM Part #6600-1708-500 (Delrin Washer only), **6600-1464-500** (Upper Buoyancy Spring only), **6600-1465-500** (Lower Buoyancy Spring only), **6600-1317-500** (Spring Spool only), **6600-1187-400** (Grommet only) & **6600-0714-401** (Lock Nut only)

BUOYANCY SPRING KIT (RIGHT)

- Includes: Upper Buoyancy Spring, Lower Buoyancy Spring, (4) Delrin Washers, (2) Spring Spools, (2) Lock Nuts (M3) (RPI Part #RPH903), Lubriplate (130AA) (RPI Part #RPL901), and Grommet

Fits: Right Upright (Motor Side)

Models: Giraffe OmniBed



RPI Part #RPH903

OEM Part # (No OEM Part # Available)

LOCKNUT (M3 - Nylok®)

- 10 per package
- Size: M3
- Material: Stainless steel with nylon insert
- Included in: Buoyancy Spring Kit (Right) (RPI Part #OMK057)

Models: Giraffe Incubator & Giraffe OmniBed

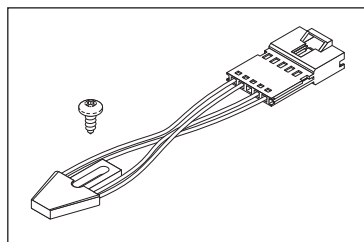

RPI Part #OMS019

OEM Part #6600-0820-700 (Sensor Only)/
6600-0709-405 (Screw Only)

AIR FLOW SENSOR

- IR Emitter / Detector pair
- Includes all parts as shown

Fits: Lower Chassis

Models: Giraffe OmniBed & Giraffe Incubator

Includes all parts as shown

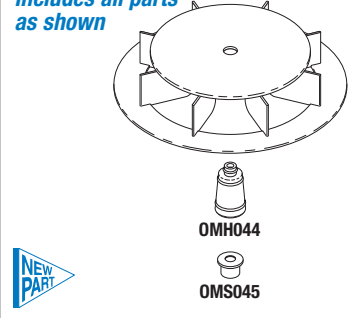

RPI Part #OMK046

OEM Part #6600-1738-500 (Fan Blade only) & **6600-1440-500** (Hub only)

FAN AND HUB KIT

- Includes: Fan Hub (RPI Part #OMH044), Fan Seal (RPI Part #OMS045), and Fan Blade

Fits: Fan Motor Shaft

Models: Giraffe Incubator & Giraffe OmniBed

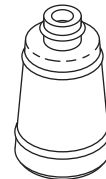

RPI Part #OMH044

OEM Part #6600-1440-500

FAN HUB

- Material: Gray rubber
- Included in: Fan and Hub Kit (RPI Part #OMK046)

Fits: Fan Blade

Models: Giraffe Incubator & Giraffe OmniBed



RPI Part #OMS045

OEM Part #6600-1557-500

FAN SEAL

- Material: Black Silicone Rubber
- Included in: Fan and Hub Kit (RPI Part #OMK046)

Fits: Fan Motor Shaft

Models: Giraffe Incubator & Giraffe OmniBed



RPI Part #RPC902

OEM Part #6600-1056-400

ARROW CLIP

- 6 per package
- Hole dia.: .250"
- Material: Nylon
- Size: .50" dia. head x .57" lg.

Fits: Soffit

Models: Giraffe OmniBed

Infant Incubators

Models: Giraffe® Incubator & Giraffe® OmniBed®

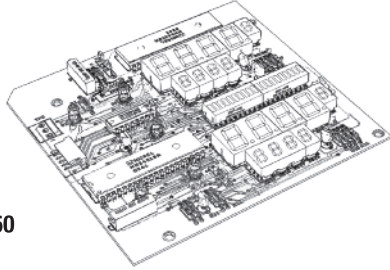

RPI Part #OMB056
OEM Part #6600-0215-850

LED PC BOARD
Fits: Display Module
Models: Giraffe Incubator & Giraffe OmniBed

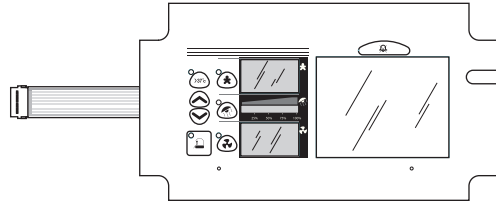

*For Use With
OmniBed!*

RPI Part #OMP021
OEM Part #6600-1007-700

TOUCH PANEL ASSEMBLY
• Size: 7.12" x 13"
• For use with OmniBed
Fits: Display Module
Models: Giraffe OmniBed

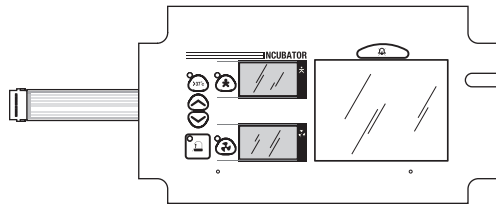

*For Use With
Incubator!*

RPI Part #OMP022
OEM Part #6600-1254-600

TOUCH PANEL ASSEMBLY
• Size: 7.12" x 13"
• For use with Incubator
Fits: Display Module
Models: Giraffe Incubator



RPI Part #OMS025
OEM Part #6600-0736-701
CANOPY LIFT SWITCH (LEFT)
Fits: Upper Chassis
Models: Giraffe OmniBed



RPI Part #OMS026
OEM Part #6600-0736-702
CANOPY LIFT SWITCH (RIGHT)
Fits: Upper Chassis
Models: Giraffe OmniBed

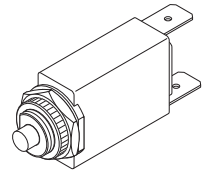

RPI Part #OMB035
OEM Part #6600-0562-603

CIRCUIT BREAKER (3.5A)
• 3.5 Amps
• 1/4" Tabs
• Includes: Mounting hardware
Fits: Connection Panel
Models: Giraffe OmniBed & Giraffe Incubator

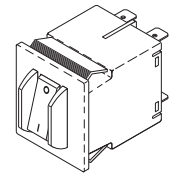

RPI Part #OMS034
OEM Part #6600-1014-602

POWER SWITCH/CIRCUIT BREAKER
• Rocker switch (on-off)
• 12A @ 125/250VAC; DPST; Trip amps: 16.2
• Black switch body with white legend: I/O
• 1/4" Tabs
Fits: Lower Electrical Enclosure
Models: Giraffe OmniBed & Giraffe Incubator

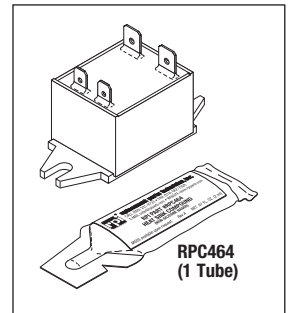

RPI Part #OMR033
OEM Part #6600-1003-600

SOLID STATE RELAY
• Size: 1.20" x 1" x .90"; 1/4" Tabs
• 12A @ 24-280VAC; SPST-N.O.
• Control voltage: 3-30 VDC
• Includes all parts as shown
Fits: Electrical Enclosure
Models: Giraffe OmniBed & Giraffe Incubator

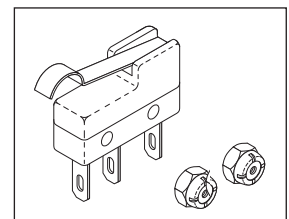

RPI Part #OMS023
OEM Part #6600-1154-600 (Switch Only)/
6600-1165-400 (Locking Nut Only)

DOOR SWITCH
• 1A @ 125VAC; SPDT; 1/8" Tabs
• Includes: Mounting hardware
Fits: Heater Doors
Models: Giraffe OmniBed

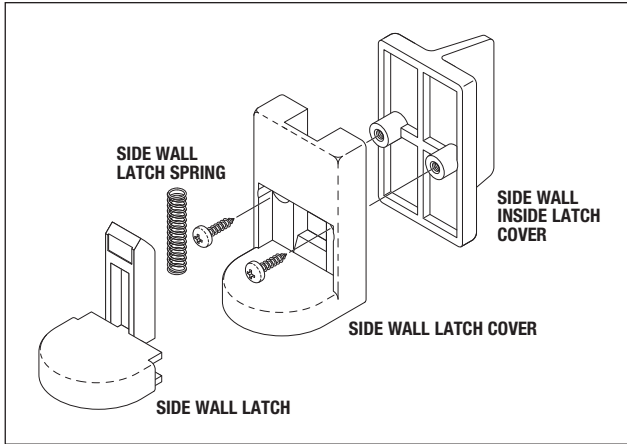

RPI Part #OMK028
OEM Part #6600-1406-500 (Inside Latch Cover only) /
6600-1403-500 (Side Wall Latch only) / **6600-1405-500**
 (Latch Spring only) / **6600-1404-500** (Latch Cover only)

SIDE WALL LATCH KIT

- Includes all parts as shown
- Fits:** Side Wall
- Models:** Giraffe OmniBed & Giraffe Incubator

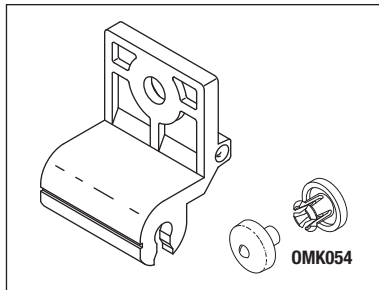

RPI Part #OMK053
OEM Part #6600-1149-500 (Side Wall Hinge only), **6600-1436-500**
 (Wall Hinge Snap only) & **6600-1429-500** (Wall Hinge Post only)

SIDE WALL HINGE KIT

- Includes: Side Wall Hinge, and Wall Hinge & Post Kit (RPI Part #OMK054)
- Fits:** Hood Assembly
- Models:** Giraffe Incubator & Giraffe OmniBed

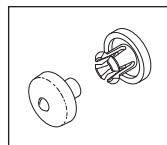

RPI Part #OMK054
OEM Part #6600-1436-500 (Wall Hinge Snap only) &
6600-1429-500 (Wall Hinge Post only)

WALL HINGE & POST KIT

- Included in: Side Wall Hinge Kit (RPI Part #OMK053)
- Fits:** Side Wall Hinge and Hood Assembly
- Models:** Giraffe Incubator & Giraffe OmniBed

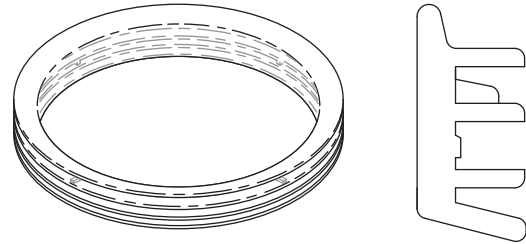

RPI Part #OMS052
OEM Part #6600-1249-500

PORTHOLE SEAL

- Material: Translucent thermoplastic rubber
- Fits:** Hood Assembly
- Models:** Giraffe Incubator & Giraffe OmniBed

OMS052
 CROSS SECTION
 SHOWN ACTUAL SIZE



RPI Part #OMD051
OEM Part #6600-1238-500

PORTHOLE DOOR

- Material: Clear plastic
- Fits:** Hood Assembly
- Models:** Giraffe Incubator & Giraffe OmniBed

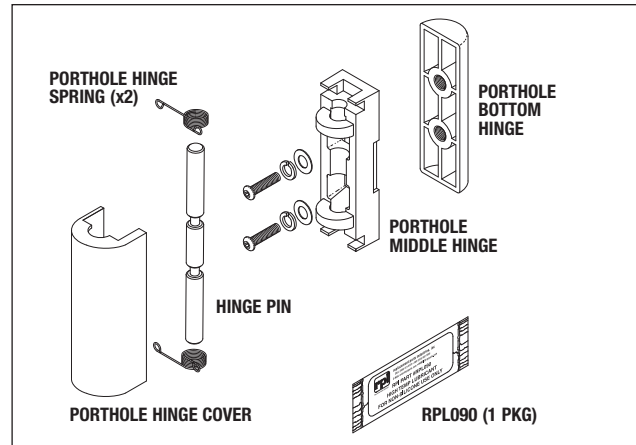
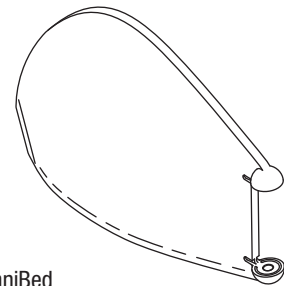

RPI Part #OMK029
OEM Part #6600-1239-500 (Hinge Bottom only) / **6600-1242-500** (Hinge Cover only) / **6600-1240-500** (Middle Hinge only) / **6600-1041-400** (Hinge Pin only) / **6600-1040-400** (Left Spring only) / **6600-1026-400** (Right Spring only)

PORTHOLE HINGE KIT

- Includes all parts as shown
- Fits:** Side Panels
- Models:** Giraffe OmniBed & Giraffe Incubator

RPI Part #OMK027
OEM Part #6600-0738-700

PORTHOLE LATCH ASSEMBLY KIT

- Includes all parts as shown
- Fits:** Side and Front Panels
- Models:** Giraffe OmniBed & Giraffe Incubator

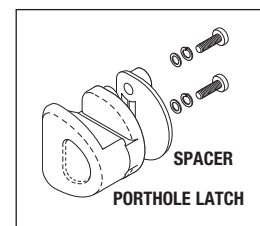

Infant Incubators

Models: Giraffe® Incubator & Giraffe® OmniBed®

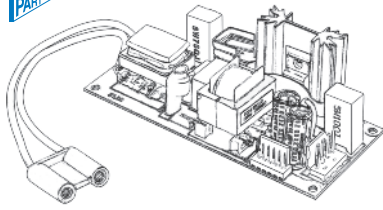

RPI Part #OMB061
OEM Part #6600-0248-850

BALLAST (50W REGULATED)

- 50 VDC, 50 W
- Used with 50W Solarc™ lamp only
- Also available: Lamp (52V, 50W) (RPI Part #LMP029)

Fits: Chassis

Models: Giraffe Spot PT Lite

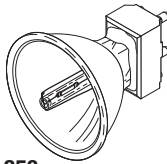

RPI Part #LMP029
OEM Part #6600-0235-850

LAMP (52VDC, 50W)

- Metal Halide Solarc™ brand
- 2 Pin
- Also available: Ballast (50W regulated) (RPI Part #OMB061)

Fits: Lamp Ballast

Models: Giraffe Spot PT Lite

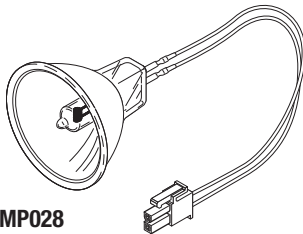

RPI Part #LMP028
OEM Part #6600-0680-200

LAMP (12VDC, 100W)

- 6 per package
- Includes: Attached wire harness and connector
- Halogen

Fits: Lamp holder

Models: Biliblanket Plus & Biliblanket Plus High Output

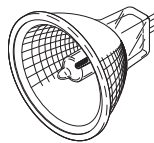

RPI Part #LMP027
OEM Part #6600-0912-200
Industry Part #EXT

LAMP

- 12V, 50W
- Base: 2-Pin; Type: Halogen; EXT

Fits: Exam Light

Models: Giraffe Exam Light, Giraffe OmniBed & Giraffe Incubator

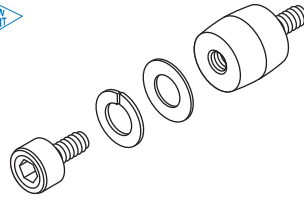

INCLUDES (6) OF EACH PART SHOWN

RPI Part #OMK050

OEM Part #6600-1099-400 (Isolator Only),
6600-0712-403 (Flat Washer Only), **6600-0713-403** (Lock Washer Only) & **6600-0707-407** (Screw Only)

LIFT MOTOR ISOLATOR KIT

- 6 per package
- Size: .39" (10mm) Dia x .39" (10mm) Ht.
- Includes: (6) Lift Motor Isolators, and mounting hardware

Fits: Right Hand Upright

Models: Giraffe OmniBed

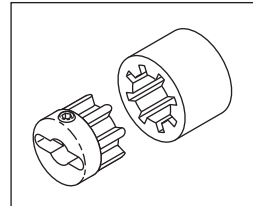

RPI Part #OMC049
OEM Part #6600-1176-400

GEARBOX COUPLER

- Includes: Cross-Clamp Hub, and Urethane Gear Grip Sleeve

Fits: Lift Motor

Models: Giraffe OmniBed

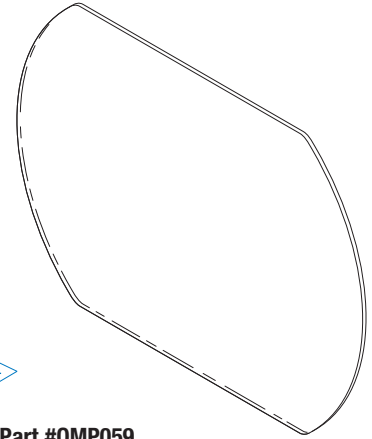

RPI Part #OMP059

OEM Part #6600-1365-500

PLATE

- Size: 25.75" x 19.25" x .13" Thk.
- Material: Clear plastic

Fits: Bed Assembly

Models: Giraffe Incubator & Giraffe OmniBed

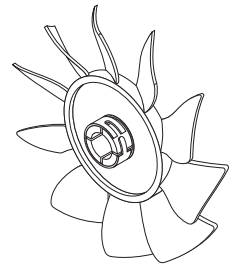

RPI Part #OMF043

OEM Part #6600-1433-500

FAN BLADE

- Size: 2.25" dia.
- Includes: Spring clip

Fits: Fan motor

Models: Giraffe Incubator & Giraffe OmniBed

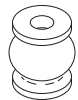

RPI Part #OMM047

OEM Part #6600-1000-400

MOTOR MOUNT

- 4 per package
- Size: .59" dia. x .63" Ht.

Fits: Fan Motor Bracket

Models: Giraffe Incubator & Giraffe OmniBed

RPI Part #OMH005

OEM Part #6600-0220-850

HEATING ASSEMBLY

- 460W, 99VAC, ~21Ω
- Includes Connector and Ground Wire Assembly

Fits: Hood Assembly

Models: Giraffe OmniBed & Giraffe Incubator

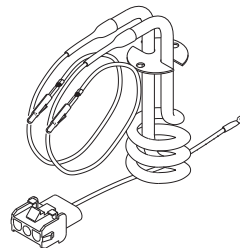

RPI Part #AIM021
OEM Part #17 776 59

PANEL METER

- 120V
- Range: 0, 1/4, 1/2, 3/4, Full
- Includes mounting bracket

Fits: Controller Front Panel
Model: ICS

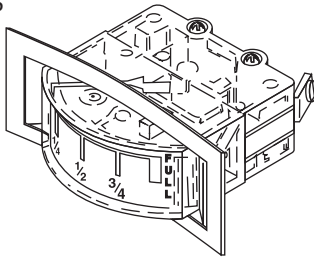

RPI Part #AIS049
OEM Part #17 681 61

SLIDE SWITCH

- DPST
- 6A AC, 0.5A DC @ 125V
- #6 clearance mounting holes

Fits: Servo Controller (SC78-1)
Model: ICS

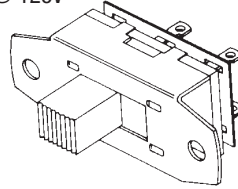

RPI Part #AIS050
OEM Part #17 681 88

SLIDE SWITCH

- DPST
- 6A AC, 0.5A DC @ 125V
- #6-32 mounting holes

Fits: Servo Controller (SC78-2)
Model: ICS

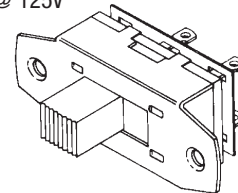

RPI Part #AIS051
OEM Part #17 681 33

SLIDE SWITCH

- SPST
- 1A@125VDC; 6A@125VAC; 3A@250VAC
- #6 clearance mounting holes

Fits: Servo Controller (SC78-1)
Model: ICS

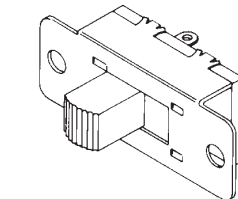

RPI Part #AIS052
OEM Part #17 681 87

SLIDE SWITCH

- DPDT
- 3A AC, 0.5A DC @ 125V
- #6-32 mounting holes

• Momentary
Fits: Servo Controller (SC78-2)
Model: ICS

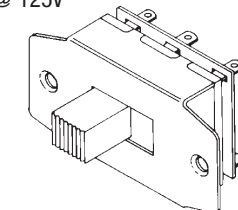

RPI Part #AIH039
OEM Part #78 902 70

HEATING ELEMENT

- ~10.50" lg.
- 560W, 120VAC, ~25Ω
- Includes all parts as shown

Fits: Heating Element Retainer
Model: ICS

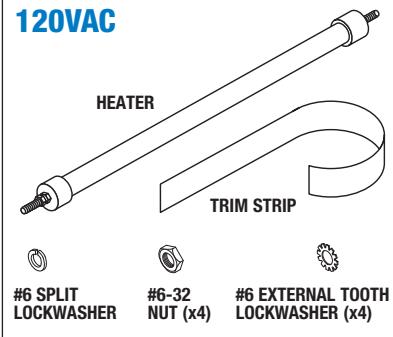

RPI Part #AIH100
OEM Part #78 200 44

HEATING ELEMENT

- ~10.50" lg.
- 560W, 220VAC, ~84Ω
- Includes all parts as shown

Fits: Heating Element Retainer
Model: ICS

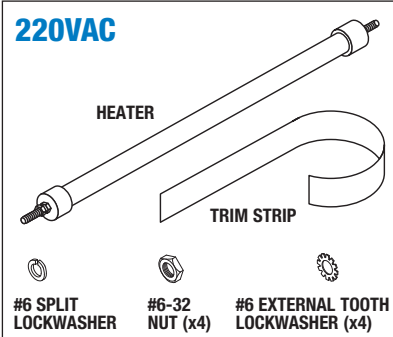

RPI Part #AIS042
OEM Part #17 724 32

BULB SOCKET

- Includes mounting hardware
- 5/16-32 lens thread
- 3/8-32 mounting thread
- 1/8" tabs

Fits: Servo Controller Panel
Model: ICS

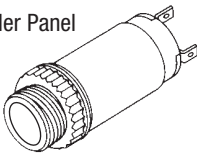

RPI Part #AIB041
OEM Part #17 806 45
Industry Part #GE345

BULB

- T-1-3/4 midget flanged
- 6VDC, .04A

Fits: Bulb socket
Model: ICS



RPI Part #AIC043
OEM Part #17 806 44

LENS CAP (WHITE)

- .33" OD
- 5/16-32 thread

Fits: Bulb Socket
Model: ICS

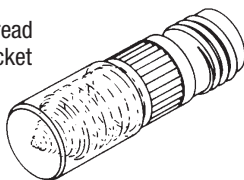

RPI Part #AIC044
OEM Part #17 806 46

LENS CAP (RED)

- .33" OD
- 5/16-32 thread

Fits: Bulb Socket
Model: ICS

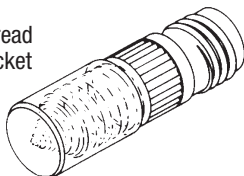

RPI Part #AIP063
OEM Part #17 575 14

SKIN TEMPERATURE PROBE (REUSABLE)

- 1/4" stereo phono plug

Fits: Controller
Model: ICS

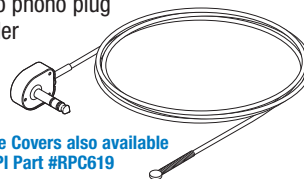

Reflective Probe Covers also available
- See RPI Part #RPC619

RPI Part #RPC619
OEM Part #MU06944 & 68 209 48

REFLECTIVE PROBE COVER

- 100 per package
- Single use only
- Metalized Mylar with PSA backing; Latex Free

Fits: Skin Temperature Probe
Models: All Infant Warmer and Incubator Skin Temperature Probes



Infant Warmers

Model: 7810 (Radiant Warmer), 7820 (Radiant Warmer), 7830 (Radiant Warmer), 7840 (Radiant Warmer) & IICS (PM 78-1)

RPI Part #AIH040
OEM Part #MU09712, 78 263 00 & 78 263 10

HEATING ELEMENT

- ~15" lg.
- 600W, 120VAC, ~24Ω

Fits: Heater Socket Assembly

Models: 7810 (Radiant Warmer), 7820 (Radiant Warmer), 7830 (Radiant Warmer), 7840 (Radiant Warmer) & IICS (PM 78-1)

120VAC

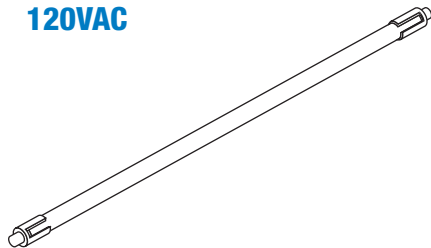

RPI Part #AIH094
OEM Part #MU09713, 78 263 11 & 78 263 01

HEATING ELEMENT

- ~15" lg.
- 600W, 220VAC, ~96Ω

Fits: Heater Socket Assembly

Models: 7810 (Radiant Warmer), 7820 (Radiant Warmer), 7830 (Radiant Warmer), 7840 (Radiant Warmer) & IICS (PM 78-1)

220VAC

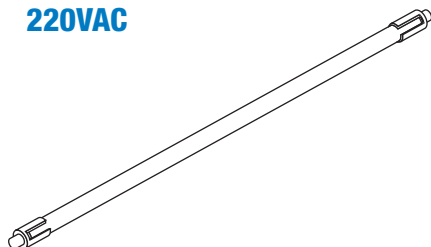

RPI Part #AIA055
OEM Part #MU10688 & 78 931 82

HEATER SOCKET ASSEMBLY

- Ceramic socket
- ~5-1/2" lg. wire

Fits: Heater/Reflector Assembly

Models: 7810 (Radiant Warmer), 7820 (Radiant Warmer), 7830 (Radiant Warmer), 7840 (Radiant Warmer) & IICS (PM 78-1)

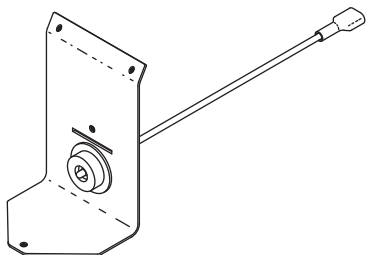

RPI Part #AIP080
OEM Part #MU06933 & 68 209 20

SKIN TEMPERATURE PROBE (DISPOSABLE)

- Includes (10) probes and (10) pieces Reflective Probe Cover (RPI Part #RPC619)
- Single use only
- 3 pin din connector

Fits: Controller

Models: 7810 (Radiant Warmer), 7820 (Radiant Warmer), 7830 (Radiant Warmer), 7840 (Radiant Warmer) & IICS (PM 78-1)

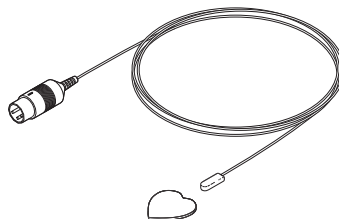

ALSO AVAILABLE BY THE CASE
RPI Part #AIP101 - 100/CASE
OEM Part #38 209 30 / MU06935

RPI Part #AIP064
OEM Part #MU06951 & 68 209 70

SKIN TEMPERATURE PROBE (REUSABLE)

- 3 pin din connector

Fits: Controller

Models: 7810 (Radiant Warmer), 7820 (Radiant Warmer), 7830 (Radiant Warmer), 7840 (Radiant Warmer) & IICS (PM 78-1)

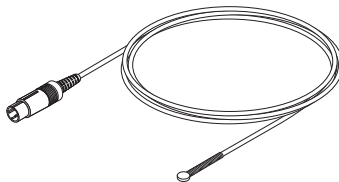

Reflective Probe Covers also available - See RPI Part #RPC619

RPI Part #RPC619
OEM Part #MU06944 & 68 209 48

REFLECTIVE PROBE COVER

- 100 per package
- Single use only
- Metalized Mylar with PSA backing; Latex Free

Fits: Skin Temperature Probe

Models: All Infant Warmer and Incubator Skin Temperature Probes



RPI Part #AIRO13
OEM Part #MU08571, MU08572, 17 652 78, 68 903 83 & 68 903 84

RELAY

- Contacts: 10A @ 24-280VAC
- Input: 3-32VDC
- Size: ~2.25" L x 1.75" W x .78" H
- Includes built-in LED Input Status Indicator

Fits: Controller

Models: 7810 (Radiant Warmer), 7820 (Radiant Warmer), 7830 (Radiant Warmer), 7840 (Radiant Warmer) & IICS (PM 78-1)

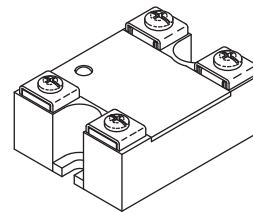

RPI Part #AIS047
OEM Part #MU3291 & 17 682 63

ROCKER SWITCH

- DPST
- 22A @ 125VAC; 16A @ 250VAC
- .250" tabs
- Color: Black

Fits: Basic Assembly

Models: 7810 (Radiant Warmer), 7820 (Radiant Warmer), 7830 (Radiant Warmer), 7840 (Radiant Warmer) & IICS (PM 78-1)

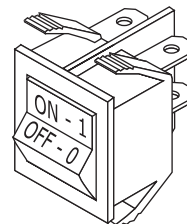

RPI Part #LMP014
OEM Part #MU03690 & 17 807 41

LAMP

- 12V, 50W
- Base: 2-pin
- Type: Halogen; EXN

Fits: Connector Assembly

Models: 7810 (Radiant Warmer), 7820 (Radiant Warmer), 7830 (Radiant Warmer), 7840 (Radiant Warmer) & IICS (PM 78-1)

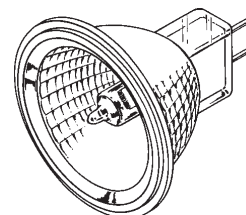

Model: Resuscitaire® RW82-1

RPI Part #AIH097
OEM Part #MU11222 & 81 202 70

HEATING ELEMENT

- ~15.50" lg.
- 741W, 120VAC, ~19Ω

Fits: Heater Connector Assembly in Hood

Model: Resuscitaire (RW82-1)

120VAC

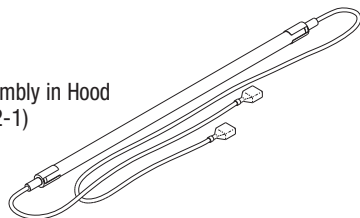

RPI Part #AIH127
OEM Part #MU11223 & 81 202 80

HEATING ELEMENT

- ~15.50" lg.
- 741W, 220VAC, ~62Ω

Fits: Heater Connector Assembly in Hood

Model: Resuscitaire (RW82-1)

220VAC

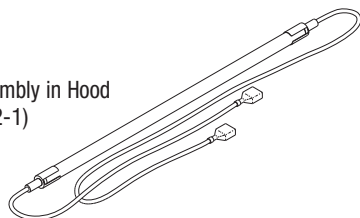

RPI Part #AIP130
OEM Part #MU11228, 81 300 06 & 81 300 08

SKIN TEMPERATURE PROBE (DISPOSABLE)

- Includes (10) probes and (10 pieces) Reflective Probe Cover (RPI Part #RPC619)
- 6 pin din plug
- Single use only

Fits: Controller

Model: Resuscitaire (RW82-1)

ALSO AVAILABLE BY THE CASE
RPI Part #AIP131 - 100/CASE
OEM Part #MU11229 & 81 300 09

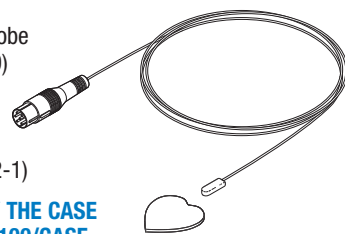

RPI Part #AIP132
OEM Part #MU11225 & 81 300 05

SKIN TEMPERATURE PROBE (REUSABLE)

- 6 pin din plug

Fits: Controller

Model: Resuscitaire (RW82-1)

*Reflective Probe Covers also available
- See RPI Part #RPC619*

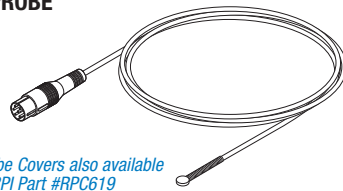

RPI Part #RPC619
OEM Part #MU06944 & 68 209 48

REFLECTIVE PROBE COVER

- 100 per package
- Single use only
- Metalized Mylar with PSA backing; Latex Free

Fits: Skin Temperature Probe

Models: All Infant Warmer and Incubator Skin Temperature Probes



Model: Versalet® 7700

RPI Part #AIH102
OEM Part #MU14092 & 84 607 83

HEATING ELEMENT

- ~18" lg.
- 350W, 120VAC, ~39Ω

Fits: Overhead Assembly

Model: Versalet 7700

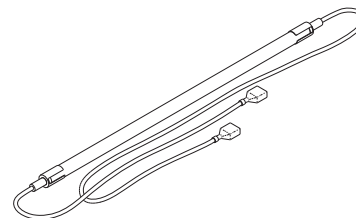

RPI Part #AIP133
OEM Part #MU12551 & 83 104 15

SKIN TEMPERATURE PROBE (DISPOSABLE)

- Includes (10) probes and (10 pieces) Reflective Probe Cover (RPI Part #RPC619)
- 6 pin connector
- Single use only

Fits: Controller

Model: Versalet 7700

ALSO AVAILABLE BY THE CASE
RPI Part #AIP134 - 100/CASE
OEM Part # (No OEM Part # Available)

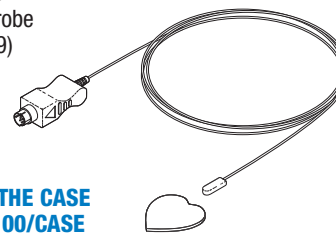

RPI Part #AIF140
OEM Part #MU12504 & 83 101 30

MICRO FILTER

- 4 per package
- ~3" x 5-1/2"
- Synthetic media - contains *no* glass fibers
- Latex free

Fits: Filter Housing

Model: Versalet 7700

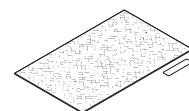

Includes installation date label

RPI Part #AIP135
OEM Part #MU12533 & 83 102 41

SKIN TEMPERATURE PROBE (REUSABLE)

- 6 pin connector

Fits: Controller

Model: Versalet 7700

*Reflective Probe Covers also available
- See RPI Part #RPC619*

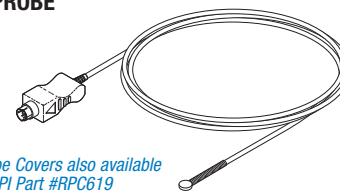

RPI Part #RPC619
OEM Part #MU06944 & 68 209 48

REFLECTIVE PROBE COVER

- 100 per package
- Single use only
- Metalized Mylar with PSA backing; Latex Free

Fits: Skin Temperature Probe

Models: All Infant Warmer and Incubator Skin Temperature Probes



Infant Warmers

Model: Versalet® 7700 (Continued)

RPI Part #AIL145
OEM Part #MU12681 (Latch Only) & 83 300 09 (Latch Only)

LATCH (HEAT SHIELD)

- Includes all parts as shown
- Fits:** Hood Assembly
- Model:** Versalet 7700

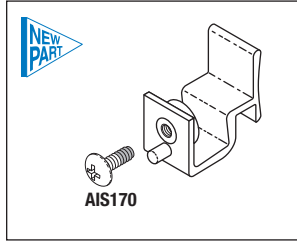

RPI Part #AIS170
OEM Part #MU15127 & 99 023 51

SCREW (#6-32 x 3/8)

- 2 per package
- Material: Stainless steel supplied with pre-applied thread locker
- Size: #6-32 x 3/8" lg. Phillips Truss Head Screw
- Also included in: Latch (Heat Shield) (RPI Part #AIL145)
- Model:** Versalet 7700

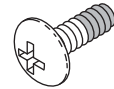

RPI Part #AIF157
OEM Part #MU12299 (Fan Only) & 83 005 46 (Fan Only)

FAN ASSY (SENSOR MODULE)

- Size: 1.575" x 1.575" x .413" fan housing
- 10.8 to 13.2 VDC; 4200 RPM
- Includes all parts as shown

Fits: Sensor Module
Model: Versalet 7700

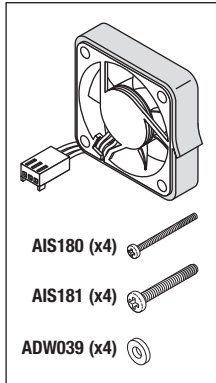

RPI Part #AIS180
OEM Part #MU15095 & 99 012 33

SCREW (#4-40 x 1)

- 4 per package
- Material: Stainless steel supplied with pre-applied thread locker
- Size: #4-40 x 1.0" lg. Phillips Pan Head Screw
- Model:** Versalet 7700

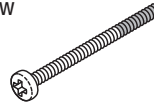

RPI Part #AIS181
OEM Part #MU15153 & 99 024 98

SCREW (#6-32 x 15/16)

- 4 per package
- Material: Stainless steel supplied with pre-applied thread locker
- Size: #6-32 x 15/16" lg. Phillips Pan Head Screw
- Model:** Versalet 7700

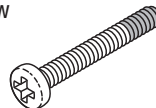

RPI Part #ADW039
OEM Part #MU15510 & 99 121 22

FLAT WASHER (#6)

- 15 per package
- Material: Nylon®
- Size: .140" ID x .320" OD x .030" thk
- Model:** Versalet 7700



RPI Part #AIC156
OEM Part #MU12287 (Cable Only) & 83 005 30 (Cable Only)

SENSOR MODULE CABLE ASSY

- Length: ~32"
- Includes all parts as shown
- Fits:** Sensor Module
- Model:** Versalet 7700

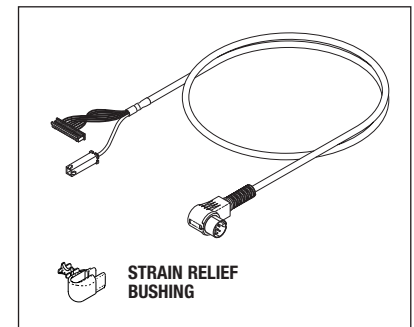

NOTES: _____

RPI Part #0MH001
OEM Part #6600-0014-850

HEATING ELEMENT

- ~19" lg.
- 540W, 104VAC, ~19Ω
- Includes (2) #10-32 x .31" lg. screws

Fits: Overhead Assembly

Models: Infant Warmer Systems (IWS) 2001, 3000, 3050, 3100, 3150, 3300 (Panda), 3400 & 3500 - with HCA or HCC Serial Numbers

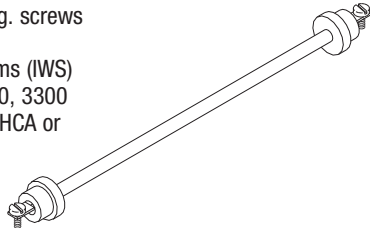

RPI Part #0MH003
OEM Part #6600-0284-800

HEATING ELEMENT

- ~19"
- 440W, 104VAC, ~23Ω
- Includes (2) #10-32 x .31" lg. screws

Fits: Overhead Assembly

Models: Infant Warmer Systems (IWS) 2001, 3000, 3050, 3100, 3150, 3300 (Panda), 3400 & 3500 - with HAJ or AAN Serial Number

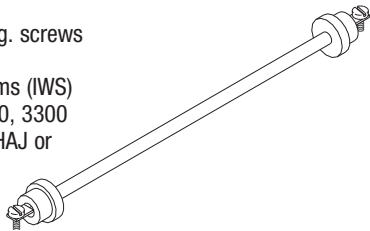

RPI Part #0MH004
OEM Part #6600-0280-800

HEATING ELEMENT

- ~23" lg.
- 540W, 104VAC, ~19Ω
- Includes (2) #10-32 x .31" lg. screws

Fits: Overhead Assembly

Models: Infant Warmer Systems (IWS) 4000, 4300, 4400 & 5000

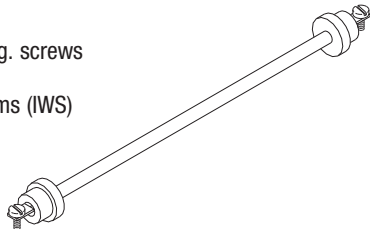

RPI Part #LMP014
OEM Part #0208-0516-300

LAMP

- 12V, 50W
- Base: 2-pin
- Type: Halogen; EXN

Fits: Connector Assembly

Model: Infant Warmer Systems (IWS) 2001, 3000, 3050, 3100, 3150, 3300 (Panda), 3400, 3500, 4000, 4300, 4400 & 5000

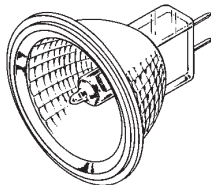

RPI Part #OMP006
OEM Part #6600-0208-700

SKIN TEMPERATURE PROBE (DISPOSABLE)

- Includes (10) probes and (10 pieces) Reflective Probe Cover (RPI Part #RPC619)
- Single use only
- 1/8" mono jack

Fits: Controller

Models: Infant Warmer Systems (IWS) 2001, 3000, 3050, 3100, 3150, 3300 (Panda), 3400, 3500, 4000, 4300, 4400 & 5000

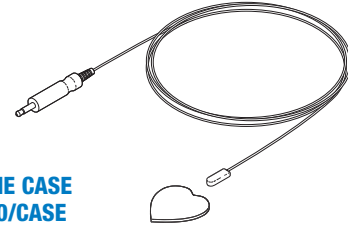

ALSO AVAILABLE BY THE CASE
RPI Part #OMP007 - 50/CASE
OEM Part #6600-0196-700

RPI Part #OMP008
OEM Part #6600-0628-700 & 0208-0697-700

SKIN TEMPERATURE PROBE (REUSABLE)

- 1/8" mono jack

Fits: Controller

Models: Infant Warmer Systems (IWS) 2001, 3000, 3050, 3100, 3150, 3300 (Panda), 3400, 3500, 4000, 4300, 4400 & 5000

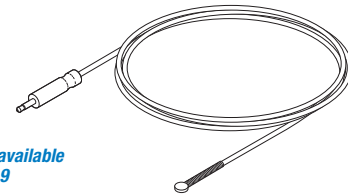

*Reflective Probe Covers also available
 - See RPI Part #RPC619*

RPI Part #RPC619
OEM Part #0203-1980-300 (Ohio•Ohmeda•GE)

REFLECTIVE PROBE COVER

- 100 per package
- Single use only
- Metalized Mylar with PSA backing; Latex Free

Fits: Skin Temperature Probe

Models: All Infant Warmer and Incubator Skin Temperature Probes



RPI is your best source for quality replacement parts.

Phototherapy Lights

Air Shields • Hill-Rom • Drager Models: PT1400, PT1400-1, PT1400-2, PT1400-2E, PT533, PTM-78-2 & IICS Phototherapy System 7850

RPI Part #LMP016
OEM Part #43 003 65

LAMP (120V, 250W)
 • Blue Phototherapy/Procedure Light
 • Base: 2 pin
 • Type: Halogen, ENH
Models: PT1400 & PT1400-1

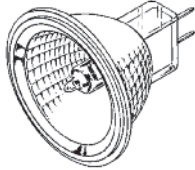

RPI Part #LMP017
OEM Part #43 004 70

LAMP (20V, 150W)
 • Cream Phototherapy/Procedure Light
 • Base: 2 pin
 • Type: Halogen, DDL
Models: PT1400-2 & PT1400-2E

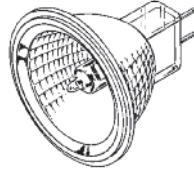

RPI Part #LMP018
OEM Part #0208-0516-300/17 807 45

LAMP (12V, 50W)
 • Base: 2 pin
 • Type: Halogen, EXZ/CC
Models: IICS Phototherapy System 7850 & PTM-78-2

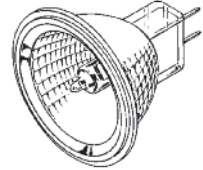

RPI Part #LMP019
OEM Part #17 806 61

FLUORESCENT LAMP (BLUE)
 • 20W, 120V
 • 1.50" OD x 24" lg.
Model: PT533

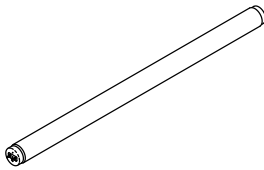

RPI Part #LMP020
OEM Part #17 806 94

FLUORESCENT LAMP (WHITE)
 • 20W, 120V
 • 1.50" OD x 24" lg.
Model: PT533

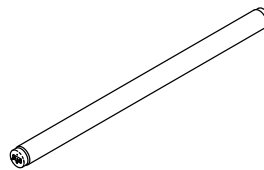

Since 1972, health-care professionals have relied on RPI for quality replacement parts.

GE • Ohmeda Models: Biliblanket Plus, Biliblanket Plus High Output, & Giraffe® Spot PT Lite

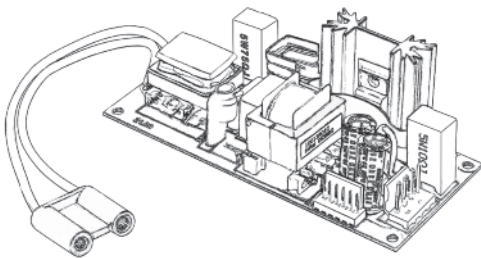

RPI Part #OMB061
OEM Part #6600-0248-850

BALLAST (50W REGULATED)
 • 50 VDC, 50 W
 • Used with 50W Solarc™ lamp only
 • Also available: Lamp (52V, 50W) (RPI Part #LMP029)
Fits: Chassis
Models: Giraffe Spot PT Lite

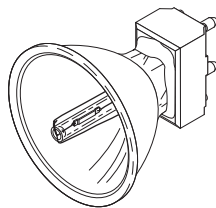

RPI Part #LMP029
OEM Part #6600-0235-850

LAMP (52VDC, 50W)
 • Metal Halide Solarc™ brand
 • 2 Pin
 • Also available: Ballast (50W regulated) (RPI Part #OMB061)
Fits: Lamp Ballast
Models: Giraffe Spot PT Lite

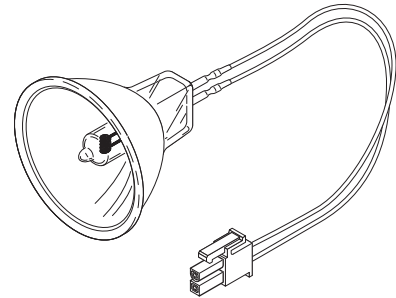

RPI Part #LMP028
OEM Part #6600-0680-200

LAMP (12VDC, 100W)
 • 6 per package
 • Includes: Attached wire harness and connector
 • Halogen
Fits: Lamp holder
Models: Biliblanket Plus & Biliblanket Plus High Output

Call Us Toll-Free Monday–Friday, 8:00 AM–4:30 PM (Pacific Time), (800) 221-9723

RPI Part #	Industry Part #	Description	Section 8 Page #
LAMPS & BULBS			
AMB028	NE51	LIGHT BULB	201
AIB041	GE345	BULB, NEON	201
LMP001	GE252	LAMP	200
LMP002	GE778	LAMP	200
LMP003	GE787	LAMP	200
LMP004	GE1460	LAMP	200
LMP005	15S11/102	LAMP	200
LMP006	FCR7023	LAMP	200
LMP007	ESA/FHD	LAMP	200
LMP008	ESB7388	LAMP	200
LMP009	GE1493	LAMP	200
LMP010	15S11/CL13	LAMP	200
LMP011	BRL7027	LAMP	200
LMP012	13347W	LAMP	200
LMP013	GE1634	LAMP	200
LMP014	EXN	LAMP	200
LMP015	25T10	LAMP	200
LMP101	GE1004	SPECTROPHOTOMETER LAMP	200
LMP102	D2A	SPECTROPHOTOMETER LAMP	200
LMP103	GE82	SPECTROPHOTOMETER LAMP	201
LMP104	BWD	SPECTROPHOTOMETER LAMP	201
LMP600	FCS	LAMP	201
LMP601	H-3	LAMP	201
LMP602	125T10/P	LAMP	201
LMP603	EJL	LAMP	201
LMP604	ENZ	LAMP	201
LMP605	ETJ	LAMP	201
LMP606	ELZ	LAMP	201
LMP607	FDS/DZE	LAMP	201
LMP608	75T3Q/CL	LAMP	201
PCL606	150T4Q/CL	LAMP	201
PCT685	N/A	SOCKET RETRACTOR TOOL	201

● NEW PART

Call Us Toll-Free Monday–Friday, 8:00 AM–4:30 PM (Pacific Time), (800) 221-9723

SECTION

8

PAGE

100

UPDATED

6/98

RPI Part #LMP001
Industry Part #GE252

LAMP

- 2.5V, .35A
- Base: Single contact, midget flanged



RPI Part #LMP007
Industry Part #ESA/FHD

LAMP

- 6V, 10W
- Base: 2-pin



RPI Part #LMP013
Industry Part #GE1634

LAMP

- 20V, 1.0A
- Base: Double contact, prefocus
- Halogen

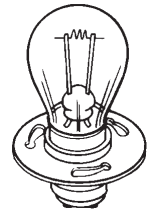

RPI Part #LMP002
Industry Part #GE778

LAMP

- 6.0V, 20W
- Base: 2-pin
- Halogen

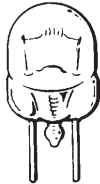

RPI Part #LMP008
Industry Part #ESB 7388

LAMP

- 6V, 20W
- Base: 2-pin



RPI Part #LMP014
Industry Part #EXN

LAMP

- 12V, 50W
- Base: 2-pin
- Incandescent

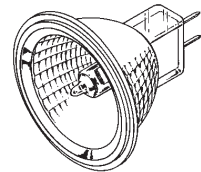

RPI Part #LMP003
Industry Part #GE787

LAMP

- 6.0V, 10W
- Base: 2-pin
- Halogen



RPI Part #LMP009
Industry Part #GE1493

LAMP

- 6.5V, 2.75A
- Base: Double contact, bayonet
- Halogen

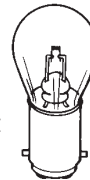

New RPI Part #LMP015
Old RPI Part #HAL007
Industry Part #25T10

LAMP

- 120V, 25W
- Base: Medium screw, prefocus

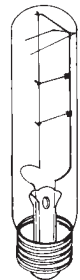

RPI Part #LMP004
Industry Part #GE1460

LAMP

- 6.5V, 2.75A
- Base: Double contact, prefocus
- Halogen

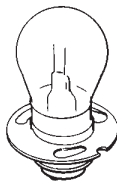

RPI Part #LMP010
Industry Part #15S11/CL13

LAMP

- 115V, 15W
- Base: Candelabra



RPI Part #LMP101
Industry Part #GE1004

SPECTROPHOTOMETER LAMP

- 12.8V, .94A
- Base: Double contact, bayonet with mounting bracket
- Halogen
- 18 GA black and red wire with connectors

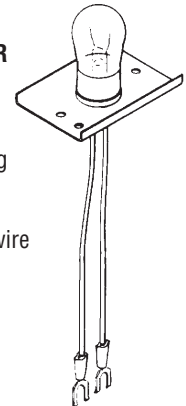

RPI Part #LMP005
Industry Part #15S11/102

LAMP

- 120V, 15W
- Base: Medium screw, prefocus

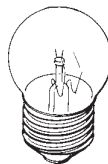

RPI Part #LMP011
Industry Part #BRL 7027

LAMP

- 12.V, 50W
- Base: Double contact, miniature



RPI Part #LMP012
Industry Part #13347W

LAMP

- 6V, 15W
- Base: Double contact, bayonet candelabra
- Halogen

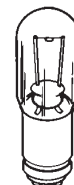

RPI Part #LMP102
Industry Part #D2A

SPECTROPHOTOMETER LAMP

- 10.8V, 30W
- Base: Mini, 2-pin

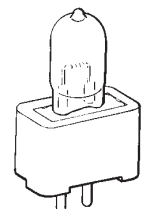

Lamps & Bulbs

RPI Part #LMP103
Industry Part #GE82

SPECTROPHOTOMETER LAMP

- 6.5V, 1.02A
- Base: Double contact, bayonet
- Halogen



RPI Part #LMP104
Industry Part #BWD

SPECTROPHOTOMETER LAMP

- 8.5V, 4.2A
- Base: Double contact, bayonet with mounting bracket
- 18 GA black and red wire 8" with connectors

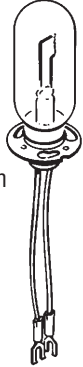

RPI Part #LMP600
Industry Part #FCS

LAMP

- 24V, 150W
- Base: 2-pin

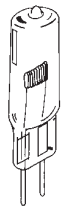

RPI Part #LMP601
Industry Part #H-3

LAMP

- 12V, 55W
- Base: Wire
- Halogen

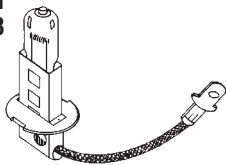

RPI Part #LMP602
Industry Part #125T10P

LAMP

- 120V, 125W
- Base: Medium, prefocus

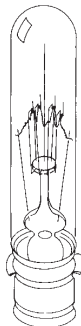

RPI Part #LMP603
Industry Part #EJL

LAMP

- 24V, 200W
- Base: 2-pin

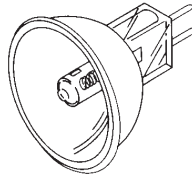

RPI Part #LMP604
Industry Part #ENZ

LAMP

- 30V, 50W
- Base: 2-pin

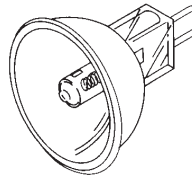

RPI Part #LMP605
Industry Part #ETJ

LAMP

- 120V, 250W
- Base: 2-pin, special

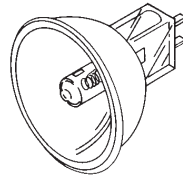

RPI Part #LMP606
Industry Part #ELZ

LAMP

- 21V, 150W
- Base: 2-pin

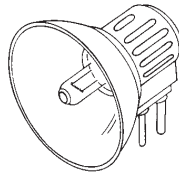

RPI Part #LMP607
Industry Part #FDS/DZE

LAMP

- 24V, 150W
- Base: 2-pin

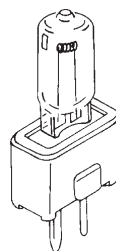

RPI Part #LMP608
Industry Part #75T3Q/CL

LAMP

- 28V, 75W
- Base: Double contact, bayonet
- Halogen

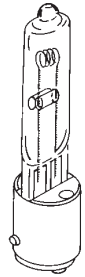

RPI Part #AMB028
Industry Part #NE51

LIGHT BULB

- Standard NE51 bulb

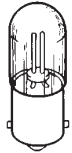

RPI Part #AIB041
Industry Part #GE345

BULB, NEON

- T3, 1/4 E10 base
- 2 watts, 24/30 VDC



RPI Part #PCL606
Industry Part #150T4Q/CL

LAMP

- 24V, 150W
- Base: Double ended
- Halogen

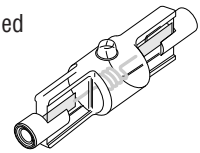

RPI Part #PCT685

SOCKET RETRACTOR TOOL

- For installation of lamp (RPI Part #PCL606)

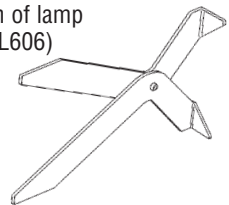

Use the handy
fax order form
located at the front
of the catalog.

OEM MODEL Section 9 Page #'s

AUTOPSY SAWS

STRYKER

810	300-301
811	300-301

CAST CUTTERS

AMERICAN ORTHOPAEDIC™

Cast Cutter	300-301
-------------------	---------

BURNETT INSTRUMENT, INC.

182106	300
--------------	-----

STRYKER

840	300-301
841	300-301
848	300-301
851	300-301
940	302-304
941	302-304

CAST SPREADERS

STRYKER

“Heavy Duty” 83	301
“Standard” 82	301

HYDROCOLLATORS

CHATTANOOGA

D3	200
E1	200-202
E2	200-202
M2	200-202
M4	200-202
SS	200-202
SS2	200-202

LOGAN

H-1 (HOT PAK)	203
---------------------	-----

VACUUMS

STRYKER

Plaster Vac 843 & 846	301
New Style “Plaster Vac” 855 & 856	301
New Style “Plaster Vac” 860 & 862	301

RPI Part #CHH015
OEM Part #22267



HEATING ELEMENT

- 1500W, 120VAC, ~10 Ω
- Includes all parts as shown
- Also available: Bracket (Element Support) (RPI Part #CHB017)

Fits: Tank
Model: M4

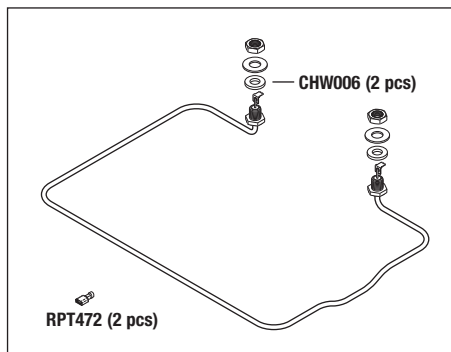

RPI Part #CHH001
OEM Part #10630

HEATING ELEMENT ASSEMBLY

- 1000W, 120VAC, ~14.5 Ω
- Includes all parts as shown

Fits: Tank
Models: E1, E2, M2, SS & SS2

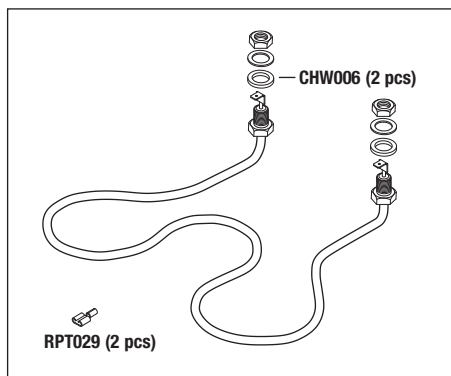

RPI Part #CHH002
OEM Part #21298

HEATING ELEMENT ASSEMBLY

- 500W, 120VAC, ~30 Ω
- Includes all parts as shown

Fits: Tank
Model: D3

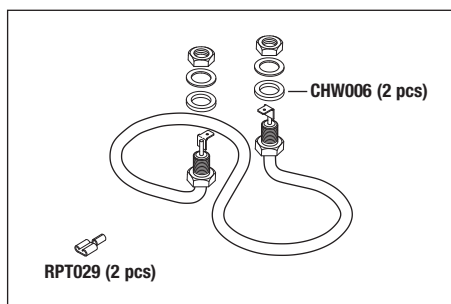

RPI Part #CHT014
OEM Part #20548



OVERHEAT THERMOSTAT

- Manually resettable, Opens at 190°F (88°C)
- 10A @ 120VAC; 5A @ 240VAC
- Capillary ~ 24" lg. with soldered fitting
- Includes all parts as shown
- Also available: Bracket (Bulb Support) (RPI Part #CHB018)

Fits: Tank
Model: M4

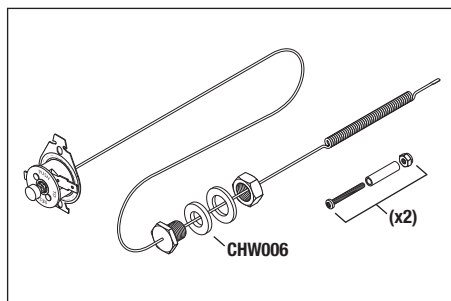

RPI Part #CHB018
OEM Part #21023



BRACKET (BULB SUPPORT)

- Material: Stainless steel
- Fits:** Attaches the Thermostat and Overheat Thermostat Capillary Bulbs to the Heating Element

Models: D3, E1, E2, M2, M4, SS & SS2

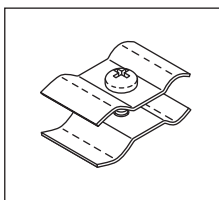

RPI Part #CHT003
OEM Part #10631

THERMOSTAT

- Off at 140°F - 170°F
- 20A @ 120/240VAC
- Includes all parts as shown
- Also available: Bracket (Bulb Support) (RPI Part #CHB018)

Fits: Mounts to Chassis and Tank
Models: D3, E1, E2, M2, M4, SS & SS2

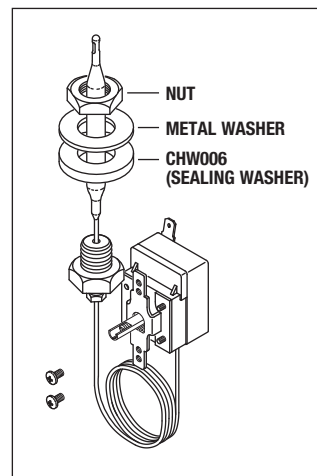

RPI Part #CHW006

OEM Part # (No OEM Part # Available)



SEALING WASHER

- 3 per package
- Size: .445" ID X .882" OD X .125" thk.
- Material: Red silicone

Fits: Thermostat and Heater Bushing

Models: D3, E1, E2, M2, M4, SS & SS2



RPI Part #CHB017
OEM Part #22356



BRACKET (ELEMENT SUPPORT)

- 2 per package
- Material: Stainless steel
- Includes all parts shown

Fits: Heating Element
Model: M4

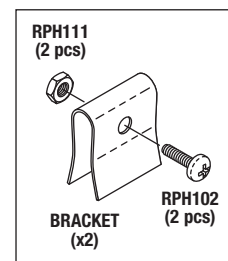

Orthopedics & Physical Therapy

Chattanooga

Models: D3, E1, E2, M2, M4, SS & SS2

RPI Part #CHS004
OEM Part #23406

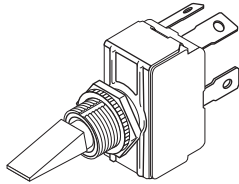

POWER SWITCH

- 20A @ 250VAC; DPST
- Switch (On-Off)
- .250" Tabs
- Includes: Mounting hardware

Fits: Chassis

Models: E1, E2, M2, M4, SS & SS2

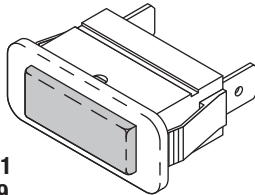

RPI Part #CHL011
OEM Part #22149

PILOT LIGHT (RED)

- 1/3W @ 125VAC
- .250" Tabs
- Red lens with white body

Fits: Chassis

Model: M4

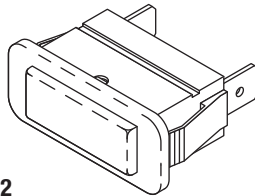

RPI Part #CHL012
OEM Part #22148 (New Style)

PILOT LIGHT (CLEAR)

- New Style: .250" Tabs and 1.181" x .433" cut out
- 1/3W @ 125VAC
- Clear lens with white body

Fits: Chassis

Models: E1, E2, M2 & M4

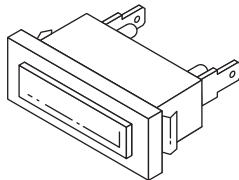

RPI Part #CHL005
OEM Part #22148 (Old Style)

STANDARD LIGHT

- Old Style: .188" Tabs and 1.281" x .395" cut out
- 1/3W @ 125VAC
- Clear lens with metal bezel

Fits: Chassis

Models: E1, E2, M2, M4, SS & SS2

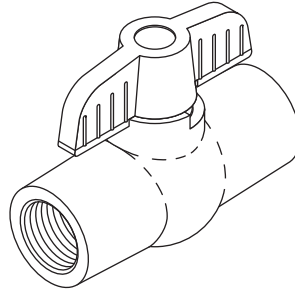

RPI Part #CHV009
OEM Part #21085

DRAIN VALVE (1/2")

- Material: PVC
- Size: 1/2" FPT Inlet and Outlet
- Also available: Coupler (RPI Part #RPC810)

Fits: Drain Pipe

Models: M2, M4 & SS2

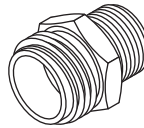

RPI Part #RPC810
OEM Part #23392

COUPLER

- Material: Brass
- Size: 1/2" MPT x 3/4" male garden hose thread
- Also available: Drain Valve (1/2") (RPI Part #CHV009)

Fits: Drain Valve

Models: M2, M4 & SS2

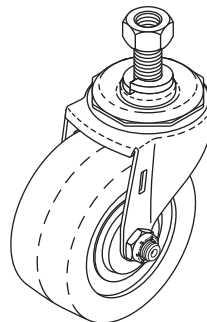

RPI Part #CHC010
OEM Part #21260

CASTER (3")

- 3" dia. x 1-1/4" wide tread
- Load Capacity: 125 lbs.
- Non-marking soft rubber tread
- 7/16-14 X 7/8" Lg. threaded stem mount
- Height: 3-5/8"; Without brake
- Zinc plated steel, ball bearing swivel
- Includes: Mounting hardware

Fits: Chassis Base

Model: M4

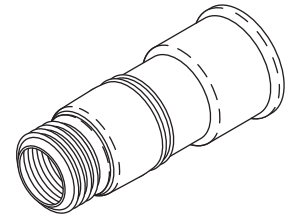

RPI Part #RPA724
OEM Part #21882

WATER THIEF

- Connects a garden hose to a threadless faucet
- Also available: Washer (Hose Bib) (RPI Part #RPH756) & Drain Hose (RPI Part #CHH016)

Fits: Drain Hose

Models: E2, M2, M4, SS & SS2

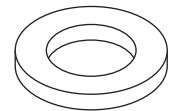

RPI Part #RPH756
OEM Part #

WASHER (HOSE BIB)

- 10 per package
- Material: Red rubber
- Fits any standard garden hose thread
- Also available: Drain Hose (RPI Part #CHH016) & Water Thief (RPI Part #RPA724)

Fits: Drain Hose

Models: E2, M2, M4, SS & SS2

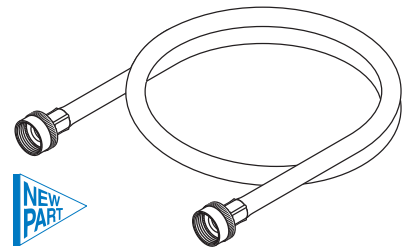

RPI Part #CHH016
OEM Part #21635

DRAIN HOSE

- Material: Black rubber
- Length: 4 ft
- Fitting Size: 3/4" female garden hose thread
- Includes: (2 pcs) Washer (Hose Bib) (RPI Part #RPH756)
- Also available: Water Thief (RPI Part #RPA724)

Fits: Coupler

Models: E2, M2, M4, SS & SS2

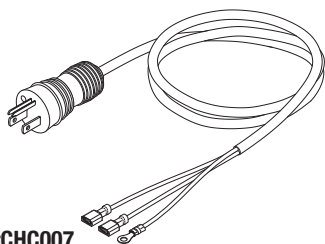

RPI Part #CHC007
OEM Part #20568

HOSPITAL GRADE POWER CORD

- Length: 8 ft.
- Splash resistant
- 14/3 SJTOW, 105°C; 15A @ 125VAC
- Plug: NEMA 5-15P; Connector: (1) #10 Ring Terminal & (2) 1/4" QC Terminals
- Color: Black; .328" OD
- Also available: Strain Relief (RPI Part #RPB164)

Fits: Chassis
Model: M4

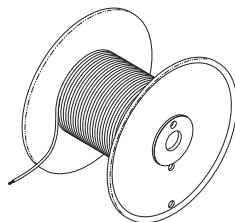

RPI Part #RPW803
OEM Part #21031 (Harness Complete), 61579
(Harness Complete) & 21617 (Harness Complete)

HOOK UP WIRE (BROWN)

- Sold by the foot (Reel NOT included); Color: Brown
- #14 AWG, 41/30 strand, UL3173
- Voltage Rating: 600V
- Insulation: Polyolefin
- Max. Operating Temperature: 257°F (125°C)

Models: E1, E2, M2, M4, SS & SS2

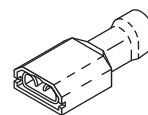

RPI Part #RPT472
OEM Part #21031 (Harness Complete), 61579
(Harness Complete) & 21617 (Harness Complete)

QC TERMINAL (1/4 FEMALE)

- 20 per package
- Fully Insulated; Color: Blue
- Size: For #14 - 16 AWG Wire

Models: E1, E2, M2, M4, SS & SS2

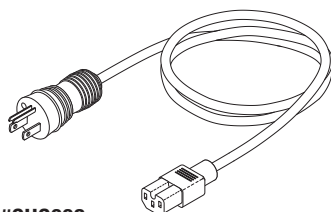

RPI Part #CHC008
OEM Part #20909

HOSPITAL GRADE POWER CORD

- Length: 8 ft.
- Splash resistant
- Black, 14/3 SJTOW, 105°C; 15A @ 125VAC
- Plug Type: NEMA 5-15P
- Connector Type: EN60320-C15 (Keyed mating feature)
- Also available: AC Inlet Receptacle (RPI Part #RPR710)

Fits: AC Inlet Receptacle
Model: M4

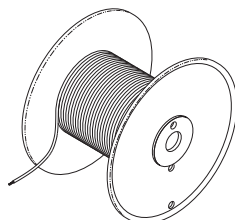

RPI Part #RPW804
OEM Part #21031 (Harness Complete), 61579
(Harness Complete) & 21617 (Harness Complete)

HOOK UP WIRE (BLUE)

- Sold by the foot (Reel NOT included); Color: Blue
- #14 AWG, 41/30 strand, UL3173
- Voltage Rating: 600V
- Insulation: Polyolefin
- Max. Operating Temperature: 257°F (125°C)

Models: E1, E2, M2, M4, SS & SS2

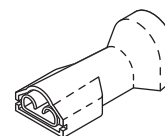

RPI Part #RPT802
OEM Part #21031 (Harness Complete), 61579
(Harness Complete) & 21617 (Harness Complete)

QC TERMINAL (1/4 FEMALE)

- 20 per package
- Fully Insulated; Color: Yellow
- For #10-12 AWG Wire

Models: E1, E2, M2, M4, SS & SS2

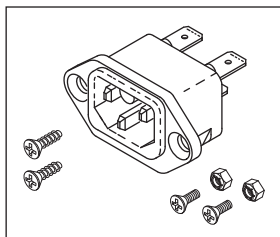

RPI Part #RPR710
OEM Part #20908

AC INLET RECEPTICLE

- 15A @ 125VAC
- .250" Tabs
- Keyed Mating feature
- Includes all parts as shown

Fits: Chassis
Model: M4

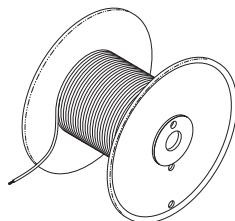

RPI Part #RPW382
OEM Part #21031 (Harness Complete), 61579
(Harness Complete) & 21617 (Harness Complete)

HOOK UP WIRE (BLACK)

- Sold by the foot (Reel NOT included); Color: Black
- #14 AWG, 41/30 strand, UL3173
- Voltage Rating: 600V
- Insulation: Polyolefin
- Max. Operating Temperature: 257°F (125°C)

Models: E1, E2, M2, M4, SS & SS2

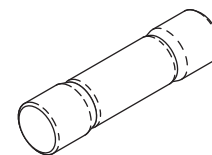

RPI Part #RPF764
OEM Part #20906

FUSE (15A) - FAST ACTING

- 1 per package
- 15A @ 600VAC
- Size: 13/32" dia. x 1-1/2" lg.

Fits: Fuse Holder
Model: M4

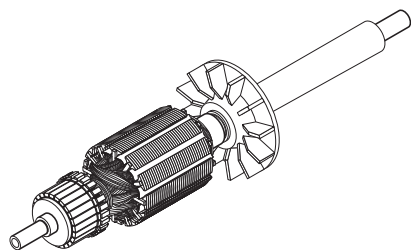

RPI Part #STA026
OEM Part #870-1-8
ARMATURE ASSEMBLY (115VAC)
 • 115 VAC
Models: Autopsy Saw: 810;
 Cast Cutter: 840 & 848

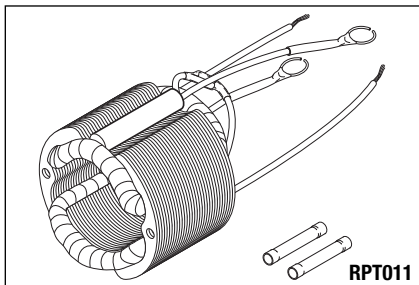

RPI Part #STF027
OEM Part #840-3-32
FIELD ASSEMBLY (115VAC)
 • 115 VAC
 • Thermal Protector built-in
 • Coil resistance ~5Ω
 • Includes (2) Butt Connector (RPI Part #RPT011)
Models: Autopsy Saw: 810;
 Cast Cutter: 840 & 848

Also fits Stryker 900 Series!

RPI Part #STB002
OEM Part #870-1-13

BRUSH
 • 2 per package
 • Size: 3/16" x 3/16" x 1/2" lg
 • Spring length: 1.000"
Fits: Brush Holder Assembly
Models: American Orthopedic Cast Cutter;
 Autopsy Saw: 810 & 811; Cast Cutter:
 840, 841, 848 & 851



RPI Part #RPC039
OEM Part # (No OEM Part # Available)

BRUSH CAP
 • 6 per package
 • 5/8-27 thread
 • Also available, Brush (RPI Part #STB002)
Models: Autopsy Saw: 810 & 811;
 Cast Cutter: 840, 841, 848 & 851



REDESIGNED! Now can be used with Stryker 800 & 900 Series!



RPI Part #STL016
OEM Part #840-1-5 (800 Series only)
SHAFT LINK
 • Hardened steel
 • Presses onto shaft
Models: American Orthopedic Cast Cutter;
 Autopsy Saw: 810 & 811;
 Cast Cutter: 840, 841, 848 & 851

This part replaces RPI Part #STB001



RPI Part #STB015
OEM Part #840-25-11
CAST CUTTER BLADE (2-1/2")
 • Use for cutting fiberglass and plaster casts
Models: Cast Cutter: 840, 841, 848 & 851
 Also fits Burnett models

REDESIGNED! Now can be used with Stryker 800 & 900 Series!

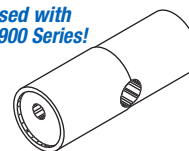

RPI Part #STT010
OEM Part # (No OEM Part # Available)
CAM TOOL
 • Use to install and remove Cam (RPI Part #STC009 & STC029)
 • ~3/4" dia. x 1-1/2" lg; Material: S.S.
 • 5/16" dia. thru hole for crossbar leverage
Models: American Orthopedic Cast Cutter;
 Autopsy Saw: 810 & 811;
 Cast Cutter: 840, 841, 848 & 851

RPI Part #STS023
OEM Part #870-1-3
SHAFT
 • Hardened steel
 • Mounts through housing
Models: Cast Cutter: 840, 841, 848 & 851

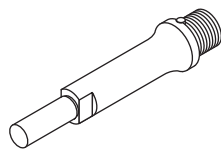

RPI Part #STC011
OEM Part #840-1-13
COLLAR
 • Mounts on top of blade
Models: Autopsy Saw: 810 & 811;
 Cast Cutter: 840, 841, 848 & 851



RPI Part #STC009
OEM Part #840-2-7
CAM
 • Mounts on tip of armature shaft
 • For easy installation/removal, use Cam Tool (RPI Part #STT010)
Models: American Orthopedic Cast Cutter;
 Autopsy Saw: 810 & 811;
 Cast Cutter: 840, 841, 848 & 851

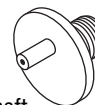

RPI Part #STW025
OEM Part #13-4
INTERNAL TOOTH WASHER
 • 3/8 thread
Fits: Shaft
Models: Autopsy Saw: 810 & 811;
 Cast Cutter: 840, 841, 848 & 851



RPI Part #STS021
OEM Part #47-5
OIL SEAL
Fits: Shaft
Models: American Orthopedic Cast Cutter;
 Autopsy Saw: 810 & 811;
 Cast Cutter: 840, 841, 848 & 851



RPI Part #STB004
OEM Part #81-147
NEEDLE BEARING
 • Hardened steel outer race
 • .1575" ID x .4063" OD x .2570" wide
Fits: Cam
Models: American Orthopedic Cast Cutter;
 Autopsy Saw: 810 & 811;
 Cast Cutter: 840, 841, 848 & 851



RPI Part #STN017
OEM Part #840-1-14
SHAFT NUT
 • 1/2" hex
 • 3/8-32 thread
Fits: Shaft
Models: American Orthopedic Cast Cutter;
 Autopsy Saw: 810 & 811;
 Cast Cutter: 840, 841, 848 & 851

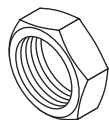

RPI Part #STB003
OEM Part #81-117
FRONT BEARING
 • 52100 steel
 • Double seal & shield
 • .3150" ID x .8661" OD x .4063" wide
Fits: Front end of Armature Shaft
Models: Autopsy Saw: 810 & 811;
 Cast Cutter: 840, 841, 848 & 851

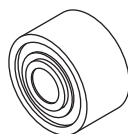

RPI Part #STB005
OEM Part #81-138
REAR BEARING
 • 52100 steel; Double seal & shield
 • .2362" ID x .7480" OD x .4063" wide
Fits: Rear end of Armature Shaft
Models: Autopsy Saw: 810 & 811;
 Cast Cutter: 840, 841, 848 & 851



Orthopedics & Physical Therapy.

American Orthopaedic™ Cast Cutter, Stryker 800 Series Autopsy Saws & Cast Cutters, and Cast Spreaders & Vacuums

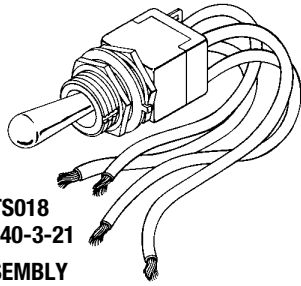

RPI Part #STS018
OEM Part #840-3-21

SWITCH ASSEMBLY

- 5 A @ 120VAC
 - On - Off toggle
 - DPDT
 - Includes 4" long wire leads and mounting hardware
- Models:** Autopsy Saw: 810 & 811;
Cast Cutter: 840, 841, 848 & 851

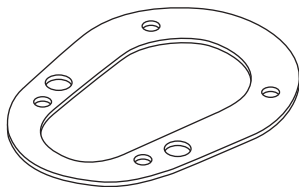

RPI Part #STG013
OEM Part #840-1-10

GASKET

- Fits:** Cover Assembly
- Models:** American Orthopedic Cast Cutter; Autopsy Saw: 810 & 811;
Cast Cutter: 840, 841, 848 & 851



RPI Part #STD012
OEM Part #840-2-4

FELT OIL DISTRIBUTOR

- Fits:** Housing Assembly
- Models:** American Orthopedic Cast Cutter; Autopsy Saw: 810 & 811;
Cast Cutter: 840, 841, 848 & 851

If it's an RPI part,
it's a part you
can trust.

VACUUMS

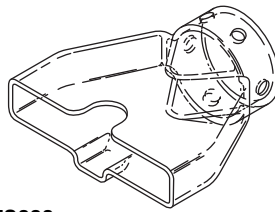

RPI Part #STG006
OEM Part #846-3-8

PLASTIC BLADE GUARD

- Mounts on Nozzle Adaptor
- Models:** "Plaster Vac" 843, 846, 855, 856, 860 & 862

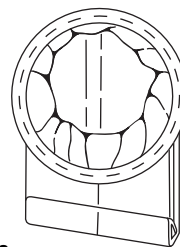

RPI Part #STB007
OEM Part #843-1-000

VACUUM BAG

- 12 per package
 - Disposable
- Fits:** Inside Cloth Bag
- Models:** "Plaster Vac" 843 & 846

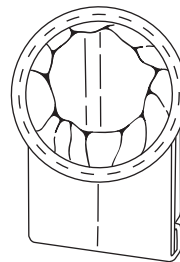

RPI Part #STB008
OEM Part #856-1-36

VACUUM BAG

- 12 per package
 - Disposable
- Fits:** Inside Cloth Bag
- Models:** "Plaster Vac" 843, 846, 855, 856, 860 & 862

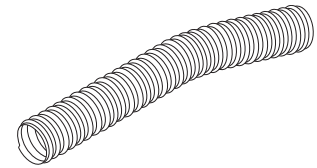

RPI Part #STH014
OEM Part #843-3-13

VACUUM HOSE

- 1-1/2" OD x 57" long
- Fits:** Standpipe Assembly
- Models:** "Plaster Vac" 843, 846, 855, 856, 860 & 862

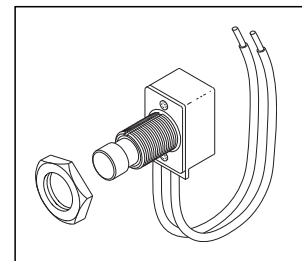

RPI Part #STS024
OEM Part #856-1-50

SWITCH ASSEMBLY

- 10 A @ 125VAC, 1/3 HP
 - Push On - Push Off
 - SPST
 - Includes 6" long wire leads and mounting hardware
- Model:** "Plaster Vac" 843, 846, 855, 856, 860 & 862

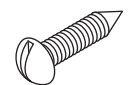

RPI Part #STS022
OEM Part #843-3-23

RETAINING SCREW

- Has pointed end
- Fits:** Nozzle Adaptor (RPI Part #STG006)
- Model:** "Plaster Vac" 843, 846, 855, 856, 860 & 862

CAST SPREADERS

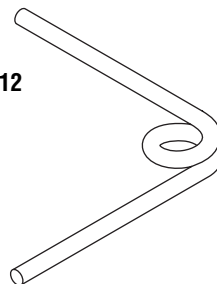

RPI Part #STS020
OEM Part #82-1-012

COIL SPRING

- Fits:** "Standard" Cast Spreader
- Model:** 82

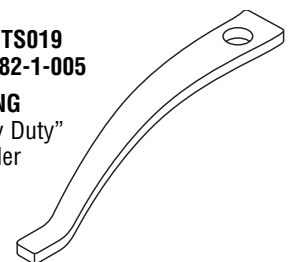

RPI Part #STS019
OEM Part #82-1-005

FLAT SPRING

- Fits:** "Heavy Duty" Cast Spreader
- Model:** 83

RPI Part #STA028
OEM Part # (No OEM Part # Available)
ARMATURE ASSEMBLY (115VAC)
 • 115 VAC
 • Includes Armature Washer Kit (RPI Part #STK033)
Models: Cast Cutter: 940

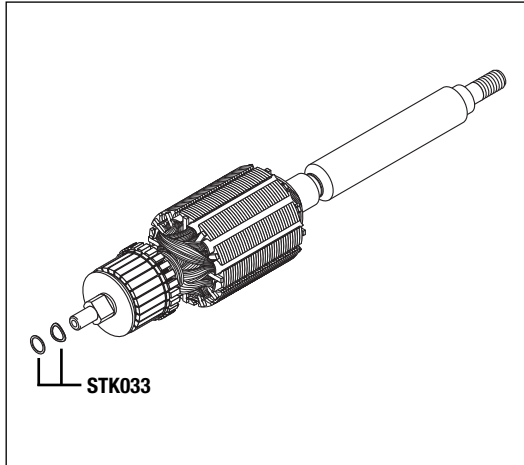

RPI Part #STK033
OEM Part # (No OEM Part # Available)
ARMATURE WASHER KIT
 • Stainless steel
 • .195" ID x .245" OD
 • Includes flat washer and wave washer
Fits: Armature
Models: Cast Cutter: 940 & 941

Also fits 800 Series!

RPI Part #STB002
OEM Part #940-1-113 (Brush only) & 38-49 (Spring only)

BRUSH
 • 2 per package
 • Size: 3/16" x 3/16" x 1/2" lg
 • Spring length: 1.000"
Fits: Brush Holder Assembly
Models: Cast Cutter: 940 & 941

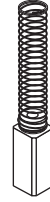

RPI Part #RPC667
OEM Part #58-18

BRUSH CAP
 • 6 per package
 • 7/16-24 thread
Models: Cast Cutter: 940 & 941



RPI Part #STB031
OEM Part # (No OEM Part # Available)
FRONT BEARING
 • Stainless steel
 • .2500" ID x .6250" OD x .1960" Wide
 • Factory oiled
 • Double shielded
Models: Cast Cutter: 940 & 941

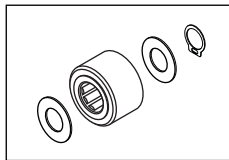

RPI Part #STK030
OEM Part #28-111 (Retaining Ring only), 11-275 (Washers only), 81-118 (Needle Bearing only)
ROLLER BEARING KIT
 Includes Needle Bearing (RPI Part #STB004), retaining ring, and (2) washer
Models: Cast Cutter: 940 & 941



RPI Part #STB032
OEM Part # (No OEM Part # Available)
REAR BEARING
 • Stainless steel
 • .1875" ID x .5000" OD x .1960" Wide
 • Factory oiled
 • Double shielded
Models: Cast Cutter: 940 & 941

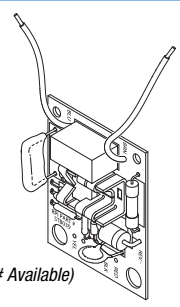

RPI Part #STB039
OEM Part # (No OEM Part # Available)
POWER SUPPLY PCB
 • 115VAC
 • Also available, Fuse (RPI Part #RPF665)
Fits: Power Supply Module
Models: 940

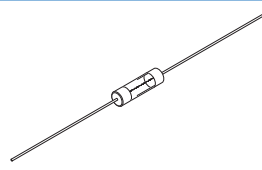

RPI Part #RPF665
OEM Part # (No OEM Part # Available)
AXIAL LEAD FUSE (2-1/2A)
 • 5 per package
 • Amps: 2-1/2A; Volts: 250V
 • Type: 2AG glass; Time Delay
 • .20" dia. x .58" lg. body x 1.50" lg. leads
Fits: Power Supply Module
Models: Cast Cutter: 940

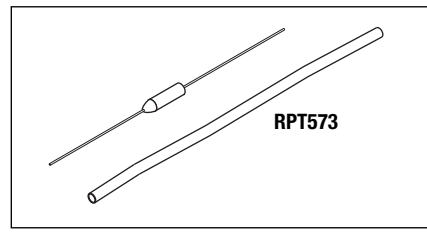

RPI Part #STF036
OEM Part # (No OEM Part # Available)
THERMAL FUSE (104°C)
 • Opens at 104°C
 • Includes (1 piece) Heat Shrink Tubing (RPI Part #RPT573)
Models: Cast Cutter: 940 & 941



Now can be used with 800 & 900 Series!



RPI Part #STT010
OEM Part # (No OEM Part # Available)
CAM TOOL
 • Use to install and remove Cam (RPI Part #STC029 & STC009)
 • ~ 3/4" dia. x 2" lg
 • Stainless steel
 • 5/16" dia. thru hole for crossbar leverage
Models: Cast Cutter: 940 & 941

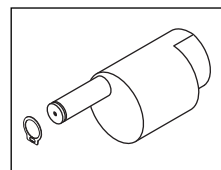

RPI Part #STC029
OEM Part # (No OEM Part # Available)
CAM
 • Hardened steel
 • Includes retaining ring
 • For ease of installation/removal use Cam Tool (RPI Part #STT010)
Models: Cast Cutter: 940 & 941

RPI parts are guaranteed to YOUR 100% Complete Satisfaction!

Orthopedics & Physical Therapy.

900 Series Cast Cutters (continued)

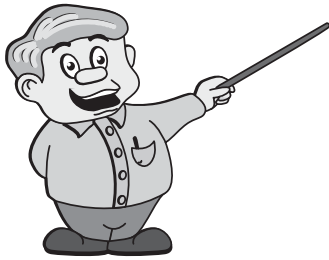

Did You Know ...
To access the housing for the Stryker 900 series cast cutters, simply remove the screws located under the Power Switch Label and cap.

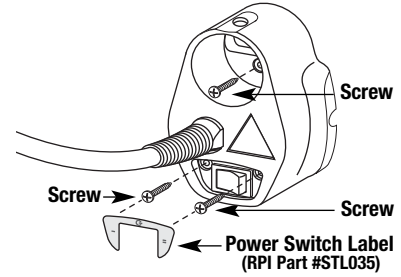

RPI Part #STS034
OEM Part #
(No OEM Part # Available)

POWER SWITCH

- SPDT
 - 6A @ 125-250VAC
 - 1/4" tabs
 - Center Off rocker - Black
 - Includes (1 piece) Heat Shrink Tubing (RPI Part #RPT573) and (1 piece) Power Switch Label (RPI Part # STL035)
 - Use Silicone Gasket Maker 598 (RPI Part #RPS639) to seal switch connections
- Models:** Cast Cutter: 940 & 941

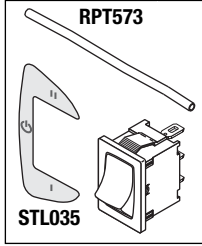

RPI Part #STL035
OEM Part # (No OEM Part # Available)

POWER SWITCH LABEL

- 3 per package
 - Grey polycarbonate
 - Use to cover case screws
- Models:** Cast Cutter: 940 & 941

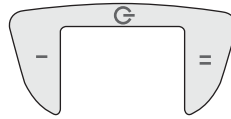

Perfect for sealing Power Switch connections!

RPI Part #RPS639
OEM Part # (No OEM Part # Available)

SILICONE GASKET MAKER 598

- .5 fl. oz.
 - Material: RTV black silicone
 - Provides a sealant for pump tubing connections or can be used to seal power switch connections
- Models:** Cast Cutter: 940 & 941

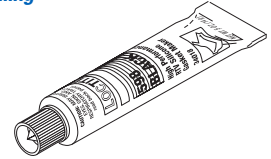

RPI Part #STK037
OEM Part # (No OEM Part # Available)

POWER CABLE KIT

- Includes (1 piece) 10' pre-stripped and tinned Cable (RPI Part #RPC671), Heat Shrink Tubing (RPI Part #RPT573), (2 pieces) Cable Tie (RPI Part #RPT083), and (2 pieces) Strain Relief Bushing (RPI Part #STB038) as shown
- Models:** Cast Cutter: 940 & 941

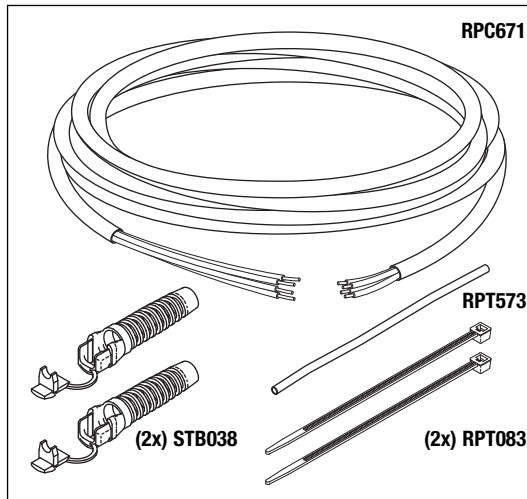

RPI Part #RPC671
OEM Part # (No OEM Part # Available)

CABLE (4 CONDUCTOR)

- 4 conductor 20 AWG 19/32
 - Colors: black, red, green, and yellow
 - White PVC jacket, UL 2464, 221°F (105°C), 300V
 - .25" OD cord
 - Sold by the foot (reel not included)
- Models:** Cast Cutter: 940 & 941

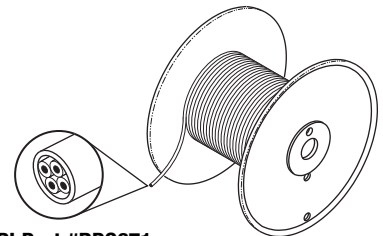

RPI Part #STB038
OEM Part # (No OEM Part # Available)

STRAIN RELIEF BUSHING

- 5 per package
 - Type: SR-5P-7; Material: white Nylon®
 - Cord type: round cable
 - Cord OD range: .250" - .290"
 - Mounting hole: 1/2"
 - Install using Strain Relief Bushing Pliers (RPI Part #RPT172)
- Models:** Cast Cutter: 940 & 941

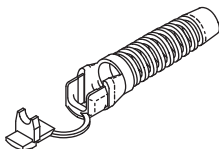

RPI Part #RPT172
OEM Part # (No OEM Part # Available)

STRAIN RELIEF BUSHING PLIERS

- Hand pliers adjustable for all bushings that assemble into mounting hole up to 7/8" dia.
 - ~7" lg.
- Models:** Cast Cutter: 940 & 941

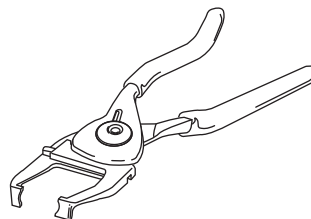

RPI Part #RPS672
OEM Part # (No OEM Part # Available)

CORD STRAP (WHITE 6")

- 3 per package
 - 6" lg.
 - EPDM
 - White strap with white button
- Models:** Cast Cutter: 940 & 941

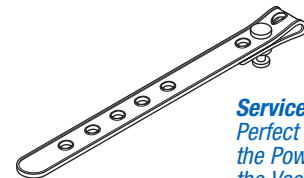

Service Tip
Perfect for strapping the Power Cord to the Vacuum Hose!



RPI Part #STA040
OEM Part #12-24, 21-129, 45-29, 50-33,
940-1-115, 940-1-118, 940-1-125

OUTPUT DRIVE ASSEMBLY

- Includes:
 O-ring (RPI Part #RPO335),
 Bearing Grease (RPI Part #RPL680),
 T-15 Torx Wrench (RPI Part #RPT700)
 and Hardware as shown
- Anodized aluminum housing; Hardened steel shaft and shaft link
- Includes Shaft Link (RPI Part #STL016) already installed

Fits: Cast Cutter Housing
Models: Cast Cutter: 940 & 941

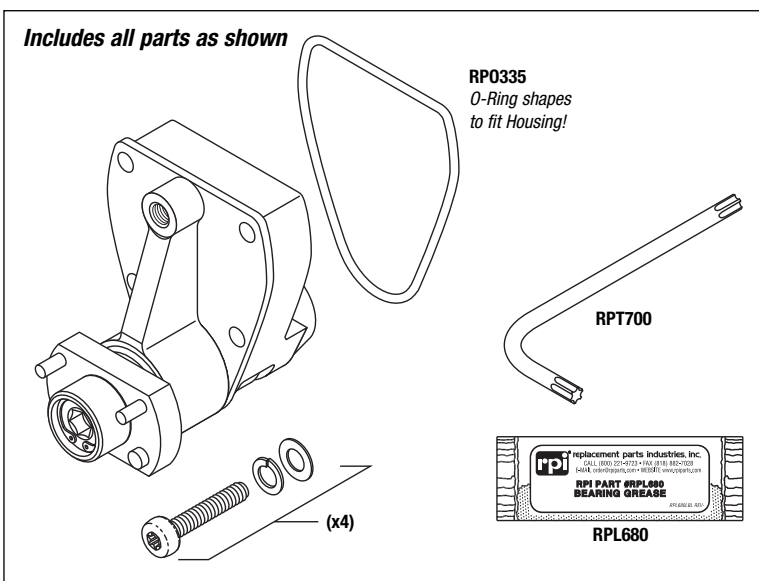

Shown Actual Size
O-Ring shapes to fit Housing

RPI Part #RPO335
OEM Part #45-29
Industry Part #AS568-029

O-RING

- 12 per package
- 1.489" ID x 1.629" OD x .070" C/S
- Material: Nitrile (Buna N)
- Duro:70

Fits: Output Drive Assembly
Models: Cast Cutter: 940 & 941



Includes (5) 0.068 fl. oz. packs



RPI Part #RPL680
OEM Part # (No OEM Part # Available)

BEARING GREASE

- 5 per package
- 0.068 fl. oz. per unit
- -54°C (-65°F) to 177°C (350°F)
- Material: Mobilith SHC100; Red synthetic grease
- MSDS and Technical Data Sheet available on RPI website

Fits: Head Assembly, Shaft Link
Models: Cast Cutter: 940 & 941

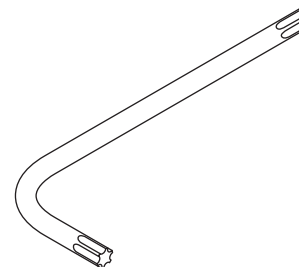

RPI Part #RPT700
OEM Part # (No OEM Part # Available)

T-15 TORX WRENCH

- Size: T-15 x 2-1/8" lg.
- Steel

Fits: Output Housing Hardware
Models: Cast Cutter: 940 & 941



Now can be used with
 800 & 900 Series!

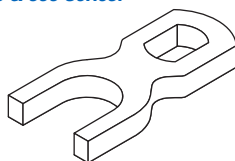

RPI Part #STL016
OEM Part # (No OEM Part # Available)

SHAFT LINK

- Hardened steel
- Presses onto shaft

Models: Cast Cutter: 940 & 941



RPI Part #PHC015
OEM Part # (No OEM Part # Available)

RETAINING CLIP

- 5 per package
- Stainless steel
- 1/4" ID

Models: Cast Cutter: 940 & 941

Orders placed before 2:00 P.M. (Pacific Time) will be shipped the same day.

Parts to fit Stryker 900 Series Cast Cutters!

RPI Part #STB043
OEM Part #940-25

CAST CUTTER BLADE

- For plaster casts
- Size: 2.36" oval blade
- Material: Stainless steel
- Also available: Cast Cutter Blade (TiN) (RPI Part #STB045) and Blade Guard (RPI Part #STG042)

Fits: Head Assembly
Models: 940 & 941

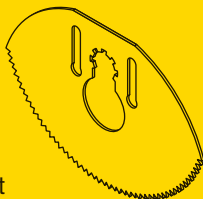

For Plaster Casts!

RPI Part #STB045
OEM Part #940-35

CAST CUTTER BLADE (TiN)

- For both plaster and synthetic casts
- Size: 2.36" oval blade
- Material: Titanium nitride coated stainless steel
- Also available: Cast Cutter Blade (RPI Part #STB043) and Blade Guard (RPI Part #STG042)

Fits: Head Assembly
Models: 940 & 941

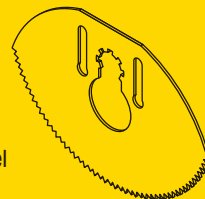

For Synthetic & Plaster Casts!

RPI Part #STG042
OEM Part #940-1-134

BLADE GUARD

- Fits: 2.36" oval blade
- Material: Clear plastic
- Includes: Mounting hardware
- Also available: Cast Cutter Blade (RPI Part #STB043) and Cast Cutter Blade (TiN) (RPI Part #STB045)

Fits: Head Assembly
Models: 940 & 941



RPI Part #STF044
OEM Part #986-500

CARTRIDGE FILTER

- 11 micron
- Size: 7.00" dia. x 11.38" lg.
- Includes: Filter with O-Ring

Fits: Vacuum Canister
Models: 986

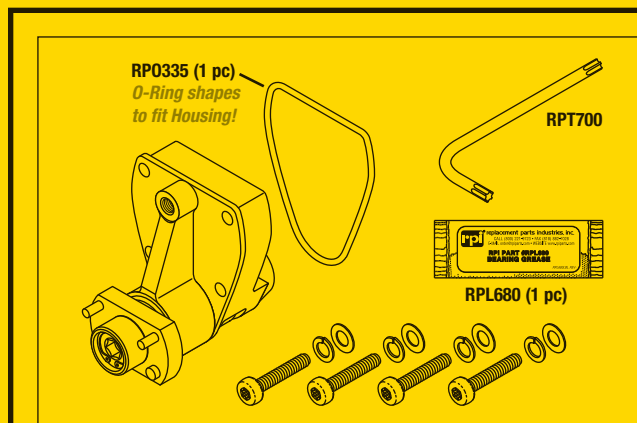
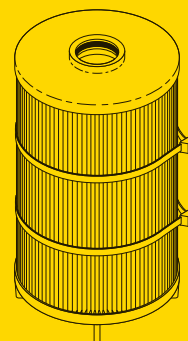

RPI Part #STA040
OEM Part #12-24, 21-129, 45-29, 50-33,
940-1-115, 940-1-118, 940-1-125

OUTPUT DRIVE ASSEMBLY

- Includes: (1 pc) O-ring (RPI Part #RPO335), (1 pc) Bearing Grease (RPI Part #RPL680), T-15 Torx Wrench (RPI Part #RPT700) and hardware. Also includes Shaft Link (RPI Part #STL016) and (1 pc) Retaining Clip (RPI Part #PHC015) already installed
- Material: Anodized aluminum housing; Hardened steel shaft and shaft link

Fits: Cast Cutter Housing
Models: 940 & 941

RPI Part #RP0335
OEM Part #45-29

O-RING

- 12 per package
- Material: Nitrile (Buna N), Duro:70
- 1.489" ID x 1.629" OD x .070" C/S

Fits: Output Drive Assembly
Models: 940 & 941



RPI Part #RPL680
OEM Part # (No OEM Part # Available)

BEARING GREASE

- 5 per package; 0.068 fl. oz. per unit
- Material: Mobilith SHC100; Red synthetic grease

Fits: Head Assembly, Shaft Link
Models: 940 & 941



RPI Part #RPT700
OEM Part # (No OEM Part # Available)

T-15 TORX WRENCH

- Material: Steel; • Size: T-15 x 2-1/8" lg.

Fits: Output Housing Hardware
Models: 940 & 941

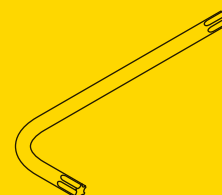

replacement parts industries, inc.

CALL (800) 221-9723 • FAX (818) 882-7028 • EMAIL order@ripiparts.com • WEBSITE www.ripiparts.com

The above parts are manufactured by Replacement Parts Industries, Inc. to fit the equipment noted. All product names used in this document are trademarks or registered trademarks of their respective holders. 1904AM Show 01/21

RPI Part #STA028
OEM Part # (No OEM Part # Available)
ARMATURE ASSEMBLY (115VAC)
 • 115 VAC
 • Includes all parts as shown
Models: 940

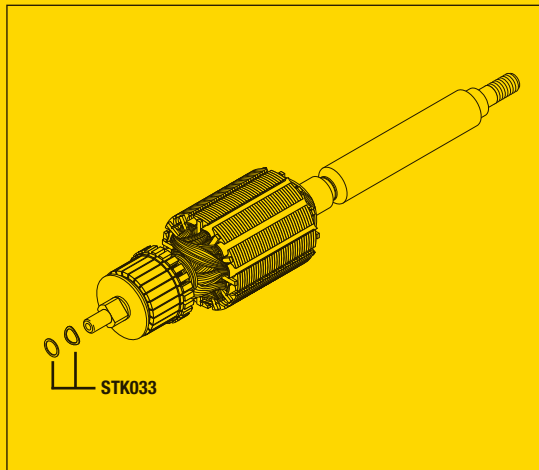

RPI Part #STK033
OEM Part # (No OEM Part # Available)
ARMATURE WASHER KIT
 • Material: Stainless steel
 • .195" ID x .245" OD
 • Includes flat washer and wave washer
Fits: Armature
Models: 940 & 941

RPI Part #STB002
OEM Part #940-1-113 (Brush only)
 & 38-49 (Spring only)

BRUSH
 • 2 per package
 • Size: 3/16" x 3/16" x 1/2" lg
 • Spring length: 1.000"
Fits: Brush Holder Assembly
Models: 940 & 941

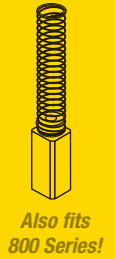

RPI Part #RPC667
OEM Part #58-18

BRUSH CAP
 • 6 per package; 7/16-24 thread
Models: 940 & 941



RPI Part #STB031
OEM Part # (No OEM Part # Available)
FRONT BEARING
 • Material: Stainless steel
 • .2500" ID x .6250" OD x .1960" Wide
 • Factory greased; Double shielded
Models: 940 & 941



RPI Part #STK030
OEM Part #28-111(Retaining Ring only), 11-275 (Washers only), 81-118/81-147 (Needle Bearing only)

ROLLER BEARING KIT
 Includes: Needle Bearing (RPI Part #STB004), retaining ring, and (2) washer
Models: 940 & 941

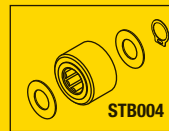

RPI Part #STB032
OEM Part # (No OEM Part # Available)
REAR BEARING
 • Material: Stainless steel
 • .1875" ID x .5000" OD x .1960" Wide
 • Factory greased; Double shielded
Models: 940 & 941



RPI Part #STB004
OEM Part #81-118/81-147

NEEDLE BEARING
 • Hardened steel outer race
 • .1575" ID x .4063" OD x .2570" wide
 • Included in: Roller Bearing Kit (RPI Part #STK030)
Fits: Cam
Models: 940 & 941



Also fits 800 Series!

RPI Part #STB039
OEM Part # (No OEM Part # Available)
POWER SUPPLY PCB
 • 115VAC
 • Also available: Fuse (RPI Part #RPF665)
Fits: Power Supply Module
Models: 940

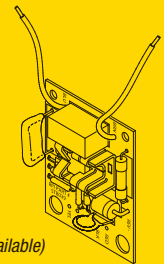

RPI Part #RPF665
OEM Part #
 (No OEM Part # Available)

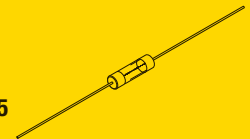

AXIAL LEAD FUSE (2-1/2A)
 • 5 per package
 • Amps: 2-1/2A; Volts: 250V
 • Type: 2AG glass; Time Delay
 • .20" dia. x .58" lg. body x 1.50" lg. leads
Fits: Power Supply Module
Models: 940

RPI Part #STT010
OEM Part # (No OEM Part # Available)
CAM TOOL
 • Use to install and remove Cam (RPI Part #STC029 & STC009)
 • 3/4" dia. x 2" lg.
 • Material: Stainless steel
Models: 940 & 941

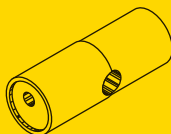

Can be used with 800 & 900 Series!

RPI Part #STL016
OEM Part # (No OEM Part # Available)

SHAFT LINK
 • Material: Hardened steel
 • Presses onto shaft
 • Included in: Output Drive Assembly (RPI Part #STA040)
 • Also available: Retaining Clip (RPI Part #PHC015)
Models: 940 & 941



Can be used with 800 & 900 Series!

RPI Part #STC029
OEM Part # (No OEM Part # Available)
CAM
 • Material: Hardened steel
 • Includes: Retaining ring
 • For ease of installation and removal use Cam Tool (RPI Part #STT010)
Models: 940 & 941

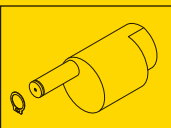

RPI Part #PHC015
OEM Part # (No OEM Part # Available)

RETAINING CLIP
 • 5 per package
 • Material: Stainless steel; 1/4" ID
 • Included in: Output Drive Assembly (RPI Part #STA040)
 • Also available: Shaft Link (RPI Part #STL016)
Models: 940 & 941

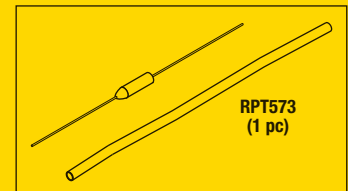

RPI Part #STF036
OEM Part # (No OEM Part # Available)
THERMAL FUSE (104°C)
 • Opens at 104°C
 • Includes (1 piece) Heat Shrink Tubing (RPI Part #RPT573)
Models: 940 & 941

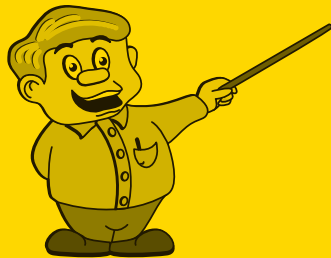

Did You Know ...

To access the housing for the Stryker 900 series cast cutters, simply remove the screws located under the Power Switch Label and cap.

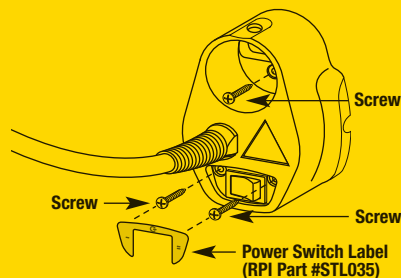

RPI Part #STS034
OEM Part #
(No OEM Part # Available)

POWER SWITCH

- SPDT
- 6A @ 125-250VAC
- 1/4" tabs
- Center Off rocker - Black
- Includes (1 pc) Heat Shrink Tubing (RPI Part #RPT573) and (1 pc) Power Switch Label (RPI Part # STL035)
- Use Adhesive (RTV108) (RPI Part #RPA874) to seal switch connections

Models: 940 & 941

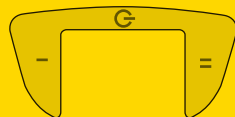
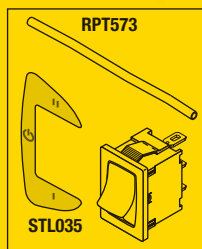

RPI Part #STL035
OEM Part # *(No OEM Part # Available)*

POWER SWITCH LABEL

- 3 per package
- Grey polycarbonate with adhesive backing
- Use to cover case screws

Models: 940 & 941

Perfect for sealing Power Switch connections!



RPI Part #RPA874
OEM Part # *(No OEM Part # Available)*

ADHESIVE (RTV108)

- Size: 2.8 fl. oz. tube
- Translucent silicone adhesive/sealant
- Temperature Range: -75°F to +400°F
- Can be used to seal power switch connections

Models: 940 & 941

RPI Part #STK037
OEM Part # *(No OEM Part # Available)*

POWER CABLE KIT

- Includes (1 pc) 10' prestripped and tinned Cable (RPI Part #RPC671), Heat Shrink Tubing (RPI Part #RPT573), (2 pcs) Cable Tie (RPI Part #RPT083), and (2 pcs) Strain Relief Bushing (RPI Part #STB038) as shown

Models: 940 & 941

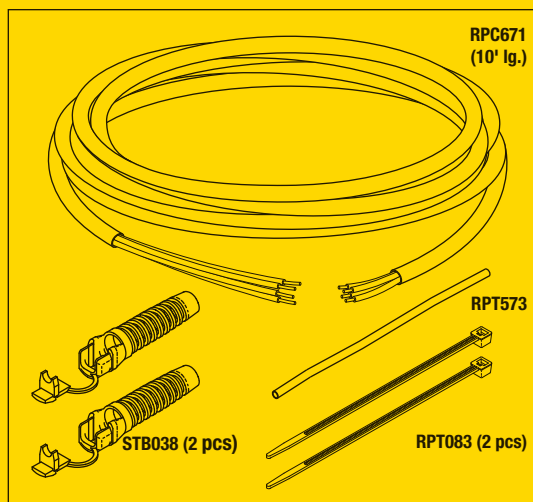

RPI Part #RPC671
OEM Part # *(No OEM Part # Available)*

CABLE (4 CONDUCTOR)

- 4 conductor #20 AWG 19/32
- Colors: Black, red, green, and yellow
- White PVC jacket, UL 2464, 221°F (105°C), 300V
- .25" OD cord
- Sold by the foot (reel not included)

Models: 940 & 941

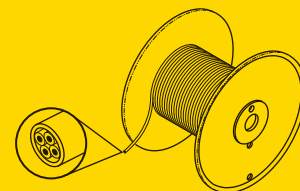

RPI Part #STB038
OEM Part # *(No OEM Part # Available)*

STRAIN RELIEF BUSHING

- 5 per package
- Type: SR-5P-7; Material: white Nylon®
- Cord type: round cable
- Cord OD range: .250" - .290"
- Mounting hole: 1/2"
- Also available: Strain Relief Bushing Pliers (RPI Part #RPT172)

Models: 940 & 941

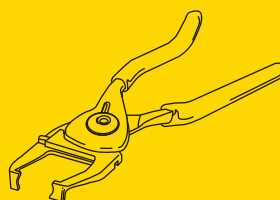
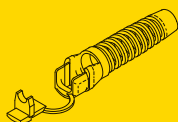

RPI Part #RPT172
OEM Part # *(No OEM Part # Available)*

STRAIN RELIEF BUSHING PLIERS

- Hand pliers adjustable for all bushings that assemble into mounting hole up to 7/8" dia.
- Size: 7" lg.

Models: 940 & 941

Service Tip
Perfect for strapping the Power Cord to the Vacuum Hose!

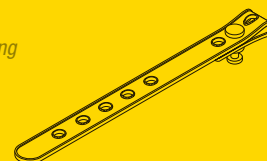

RPI Part #RPS672
OEM Part # *(No OEM Part # Available)*

CORD STRAP (WHITE 6")

- 3 per package
- 1/2" wide x 6" lg.
- EPDM
- White strap with white button

Models: 940 & 941

RPI has New Parts to fit Stryker 900 Series Cast Cutters!

For Plaster Casts!

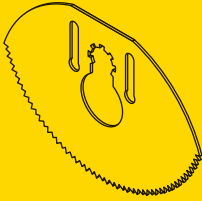

RPI Part #STB043
OEM Part #940-25

CAST CUTTER BLADE
Models: 940 & 941

For Synthetic & Plaster Casts!

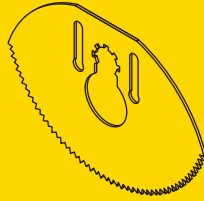

RPI Part #STB045
OEM Part #940-35

CAST CUTTER BLADE (TiN)
Models: 940 & 941

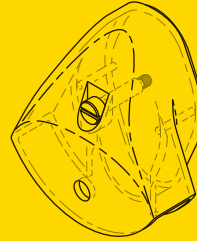

RPI Part #STG042
OEM Part #940-1-134

BLADE GUARD
Models: 940 & 941

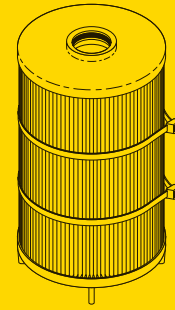

RPI Part #STF044
OEM Part #986-500

CARTRIDGE FILTER
Models: 986

New Parts to fit Stryker 900 Series Cast Cutters!

ADDRESS SERVICES REQUESTED

replacement parts industries, inc.
625 Cochran Street • Simi Valley, California • 93065



PRESORTED STANDARD
U.S. POSTAGE PAID
VAN NUYS, CA
PERMIT NO. 2399

Don't forget ... RPI also has parts to fit Stryker 800 Series Autopsy Saws, Cast Cutters and Vacuums!

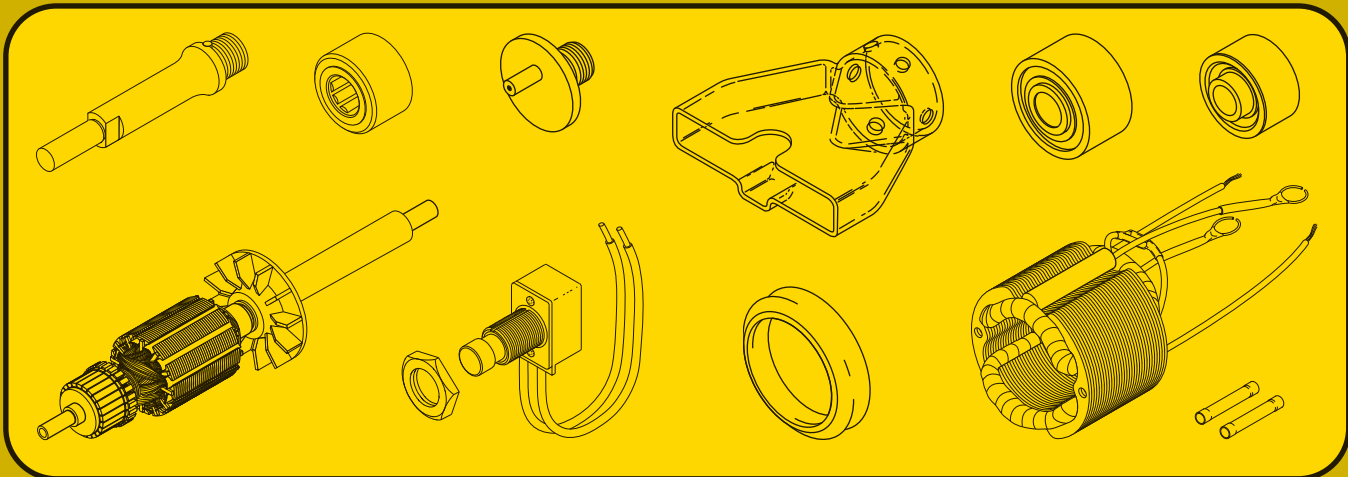



Parts to fit
Stryker® 900 Series
Cast Cutters!



For Synthetic & Plaster Casts!

RPI Part #STB056
OEM Part #940-23

CAST CUTTER BLADE (PiN)

- For both plaster and synthetic casts
- Size: 2.36" oval blade
- Material: Plasma ion nitride treated stainless steel
- Color: Matte grey
- Also available: Cast Cutter Blade (RPI Part #STB043), Cast Cutter Blade (TiN) (RPI Part #STB045), and Blade Guard (RPI Part #STG042)

Fits: Head Assembly
Models: 940 & 941



For Plaster Casts!

RPI Part #STB043
OEM Part #940-25

CAST CUTTER BLADE

- For plaster casts
- Size: 2.36" oval blade
- Material: Stainless steel
- Color: Silver
- Also available: Cast Cutter Blade (TiN) (RPI Part #STB045), Cast Cutter Blade (PiN) (RPI Part #STB056), and Blade Guard (RPI Part #STG042)

Fits: Head Assembly
Models: 940 & 941



For Synthetic & Plaster Casts!

RPI Part #STB045
OEM Part #940-35

CAST CUTTER BLADE (TiN)

- For both plaster and synthetic casts
- Size: 2.36" oval blade
- Material: Titanium nitride coated stainless steel
- Color: Gold
- Also available: Cast Cutter Blade (RPI Part #STB043), Cast Cutter Blade (PiN) (RPI Part #STB056), and Blade Guard (RPI Part #STG042)

Fits: Head Assembly
Models: 940 & 941



RPI Part #STG042
OEM Part #940-1-134

BLADE GUARD

- Fits: 2.36" oval blade
- Material: Clear blue plastic
- Includes: Mounting hardware
- Also available: Cast Cutter Blade (RPI Part #STB043), Cast Cutter Blade (TiN) (RPI Part #STB045), and Cast Cutter Blade (PiN) (RPI Part #STB056)

Fits: Head Assembly
Models: 940 & 941



RPI Part #STF044
OEM Part #986-500

CARTRIDGE FILTER

- 11 micron
- Size: 7.00" dia. x 11.38" lg.
- Includes: Filter with O-Ring

Fits: Vacuum Canister
Models: 986 Plaster Vacuum

For more RPI parts to fit Stryker 800 and 900 Series Cast Cutters as well as 800 Series Autopsy Saws, be sure to see the next page!

Complete List of RPI Parts to fit Stryker®

800 & 900 Series Cast Cutters and 800 Series Autopsy Saws!

RPI Part #	OEM Part #	Description	800 & 900 Series Cast Cutters						986 Plaster Vacuum	800 Series Autopsy Saws	
			840	841	848	851	940	941	986	810	811
PHC015	875-033007	Retaining Clip - 5/Pkg					X	X			
RPC039	<i>(No OEM Part # Available)</i>	Brush Cap - 6/Pkg	X	X	X	X				X	X
RPC667	58-18	Brush Cap - 6/Pkg					X	X			
RPC671	<i>(No OEM Part # Available)</i>	Cable (4 Conductor)					X	X			
RPF665	<i>(No OEM Part # Available)</i>	Axial Lead Fuse (2-1/2A) - 5/Pkg					X				
RPL680	<i>(No OEM Part # Available)</i>	Bearing Grease - 5/Pkg					X	X			
RPO335	45-29	O-Ring - 12/Pkg					X	X			
RPS639	<i>(No OEM Part # Available)</i>	Silicone Gasket Maker 598					X	X			
RPS672	<i>(No OEM Part # Available)</i>	Cord Strap (White 6") - 3/Pkg					X	X			
RPT172	<i>(No OEM Part # Available)</i>	Strain Relief Bushing Pliers					X	X			
RPT700	<i>(No OEM Part # Available)</i>	T-15 Torx Wrench					X	X			
STA026	870-1-8	Armature Assembly	X		X					X	
STA028	<i>(No OEM Part # Available)</i>	Armature Assembly					X				
STA040	12-24, 21-129, 45-29, 50-33, 940-1-115, 940-1-118 & 940-1-125	Output Drive Assembly					X	X			
STB002	870-1-13, 940-1-113 (Brush only), 38-49 (Spring only)	Brush - 2/Pkg	X	X	X	X	X	X		X	X
STB003	81-117	Front Bearing	X	X	X	X				X	X
STB004	81-118/81-147	Needle Bearing	X	X	X	X	X	X		X	X
STB005	81-138	Rear Bearing	X	X	X	X				X	X
STB015	840-25-11	Cast Cutter Blade (2-1/2")	X	X	X	X					
STB031	<i>(No OEM Part # Available)</i>	Front Bearing					X	X			
STB032	<i>(No OEM Part # Available)</i>	Rear Bearing					X	X			
STB038	<i>(No OEM Part # Available)</i>	Strain Relief Bushing - 5/Pkg					X	X			
STB039	<i>(No OEM Part # Available)</i>	Power Supply PCB					X				
STB043	940-25	Cast Cutter Blade					X	X			
STB045	940-35	Cast Cutter Blade (TiN)					X	X			
STB056	940-23	Cast Cutter (PiN)					X	X			
STC009	840-2-7	Cam	X	X	X	X				X	X
STC011	840-1-13	Collar	X	X	X	X				X	X
STC029	<i>(No OEM Part # Available)</i>	Cam					X	X			
STD012	840-2-4	Felt Oil Distributor	X	X	X	X				X	X
STF027	840-3-32	Field Assembly	X		X					X	
STF036	<i>(No OEM Part # Available)</i>	Thermal Fuse (104°C)					X	X			
STF044	986-500	Cartridge Filter							X		
STG013	840-1-10	Gasket	X	X	X	X				X	X
STG042	940-1-134	Blade Guard					X	X			
STK030	28-111 (Retaining Ring only), 11-275 (Washer only), 81-118/ 81-147 (Needle Bearing only)	Roller Bearing kit					X	X			
STK033	<i>(No OEM Part # Available)</i>	Armature Washer Kit					X	X			
STK037	<i>(No OEM Part # Available)</i>	Power Cable Kit					X	X			
STL016	840-1-5 (800 Series only)	Shaft Link	X	X	X	X	X	X		X	X
STL035	<i>(No OEM Part # Available)</i>	Power Switch Label - 3/Pkg					X	X			
STN017	840-1-14	Shaft Nut	X	X	X	X				X	X
STS018	840-3-21	Switch Assembly	X	X	X	X				X	X
STS021	47-5	Oil Seal	X	X	X	X				X	X
STS023	870-1-3	Shaft	X	X	X	X					
STS034	<i>(No OEM Part # Available)</i>	Power Switch Label - 3/Pkg					X	X			
STT010	<i>(No OEM Part # Available)</i>	Cam Tool	X	X	X	X	X	X		X	X
STW025	13-4	Internal Tooth Washer	X	X	X	X				X	X



... Proud to be a Healthcare Components Group company ...



HEALTHCARE
Components Group

STRYKER

New Parts to fit

Stryker® 900 Series

Plaster Vacuums & Cast Cutters

Did You Know?

To remove the case screws for the Stryker 986 CastVac™, simply remove the perforated aluminum plate to access the Nylok nuts. Note: Removing the perforated aluminum plate will rip/tear the Motor Gasket (RPI Part #STG049).

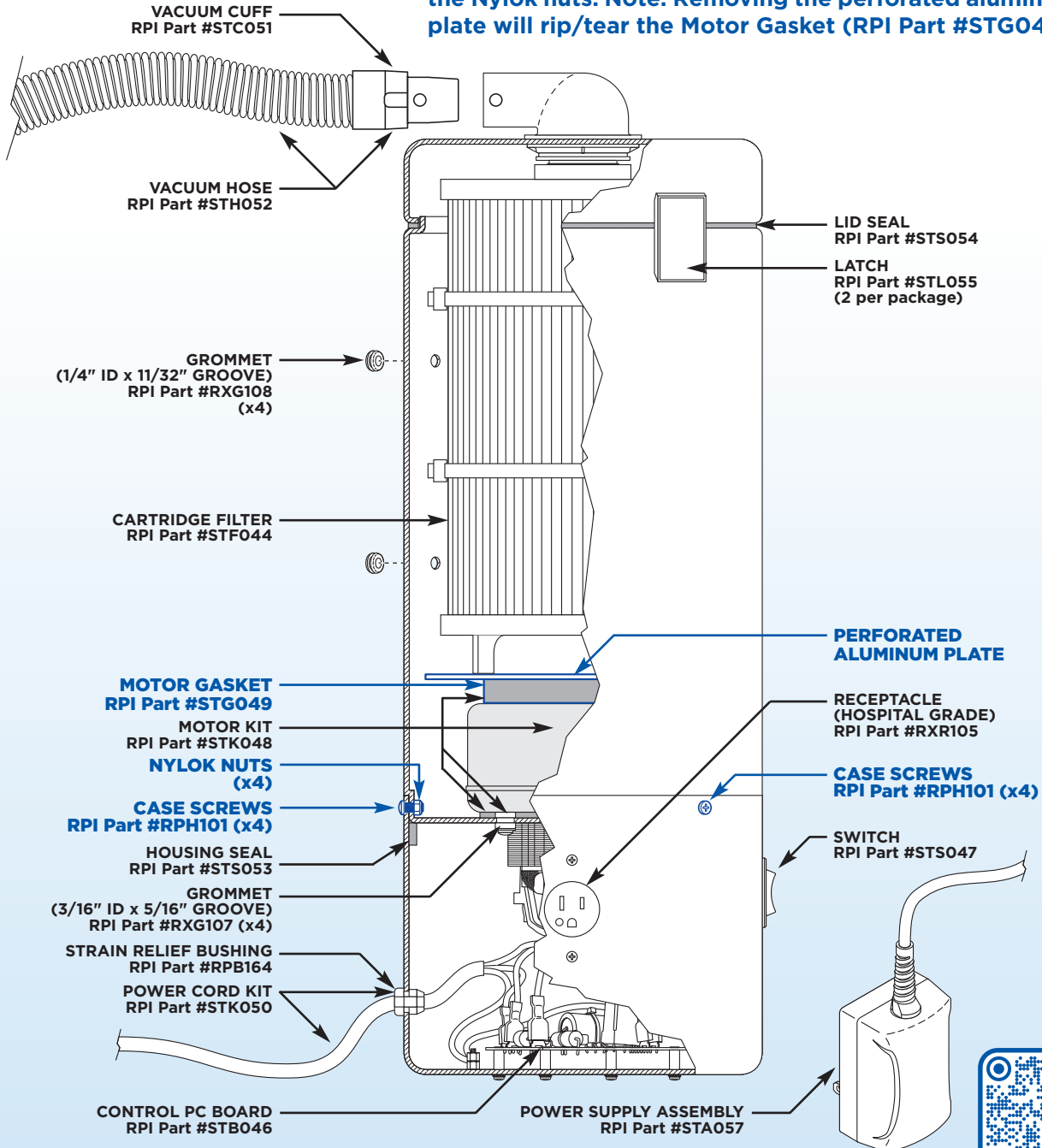

replacement parts industries, inc. A Healthcare Components Group Company

CALL (800) 221-9723 • FAX (818) 882-7028 • EMAIL order@rpiparts.com • WEBSITE www.rpiparts.com

The above parts are manufactured by Replacement Parts Industries, Inc. to fit the equipment noted. All product names used in this document are trademarks or registered trademarks of their respective holders. 2131ST Web 01/23

SECTION
9

PAGE
308

UPDATED
01/23

rpi Parts to fit Stryker® 900 Series Plaster Vacuums

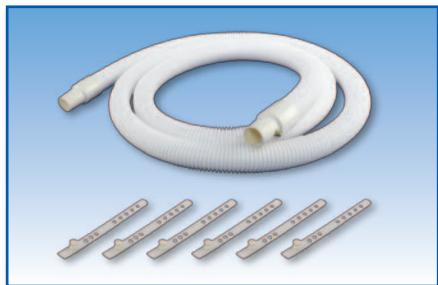

RPI Part #STH052
OEM Part #986-1-30

VACUUM HOSE

- 104" lg., 1.0" OD, White
- Includes: (2 pcs) Vacuum Cuff (RPI Part #STC051) and (6 pcs) Cord Strap (White 6") (RPI Part #RPS672)

Fits: Chassis

Models: 986, 987 & 996



x2

RPI Part #STC051

OEM Part # (No OEM Part # Available)

VACUUM CUFF

- 2 per package
- Size: 1" dia., white TPE
- Includes: Lock button and spring
- Included in: Vacuum Hose (RPI Part #STH052)

Fits: Vacuum Hose

Models: 986, 987 & 996



RPI Part #STB046

OEM Part # (No OEM Part # Available)

CONTROL PC BOARD

- Size: 4.00" x 3.00"
- Includes: Installed 1/4" quick connect terminals and #6-32 x .50" threaded standoffs

Fits: Chassis

Models: 986 & 987



RPI Part #STK048

OEM Part # (No OEM Part # Available)

MOTOR KIT

- 120VAC, thru-flow discharge, single speed, double ball bearings
- Includes: Motor Gasket (RPI Part #STG049), (1 pkg) Grommet (3/16" ID x 5/16" Groove) (RPI Part #RXG107), and mounting hardware

Fits: Chassis

Models: 986 & 987

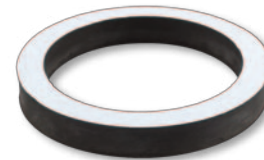

RPI Part #STG049

OEM Part # (No OEM Part # Available)

MOTOR GASKET

- Size: 4.00" ID x 5.00" OD x .63" thk., PSA on top and bottom with release liner
- Material: Polyurethane closed cell foam
- Included in: Motor Kit (RPI Part #STK048)

Fits: Motor

Models: 986, 987 & 996

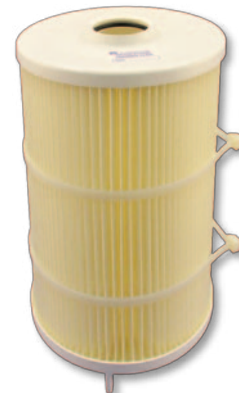

RPI Part #STF044

OEM Part #986-500

CARTRIDGE FILTER

- 11 micron
- Size: 7.00" dia. x 11.38" lg.
- Includes: Filter with O-Ring

Fits: Vacuum Canister

Models: 986 Plaster Vacuum



Parts to fit Stryker® 900 Series Plaster Vacuums

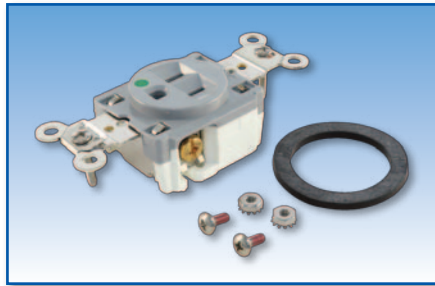

RPI Part #RXR105

OEM Part # (No OEM Part # Available)

RECEPTACLE (HOSPITAL GRADE)

- Single hospital grade receptacle; Color: Grey
- Includes: Sealing gasket with PSA and mounting hardware as shown

Fits: Chassis

Models: 986, 987 & 996

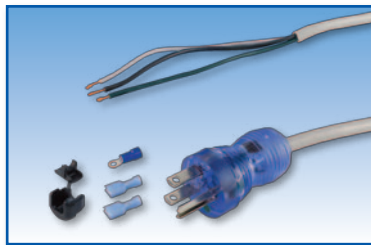

RPI Part #STK050

OEM Part # (No OEM Part # Available)

POWER CORD KIT

- 12 ft. lg., 16/3 SJT, hospital grade 5/15, gray
- Includes: (1 pc) Strain Relief Bushing (RPI Part #RPB164), (2 pcs) QC Terminal (1/4 Female) (RPI Part #RPT472), and (1 pc) #6 Ring Terminal (RPI Part #RPT005)
- Also available: Strain Relief Bushing Pliers (RPI Part #RPT172)

Fits: Chassis

Models: 986



RPI Part #RPB164

OEM Part # (No OEM Part # Available)

STRAIN RELIEF BUSHING

- 8 per package
- Type: SR-6N3-4
- Accommodates: .325" - .360" dia. round cable.
- Mounting Hole: 5/8" dia. x 1/8" thk. panel max.
- Included in: Power Cord Kit (RPI Part #STK050)
- Also available: Strain Relief Bushing Pliers (RPI Part #RPT172)

Fits: Vacuum Housing

Models: 986, 987 & 996

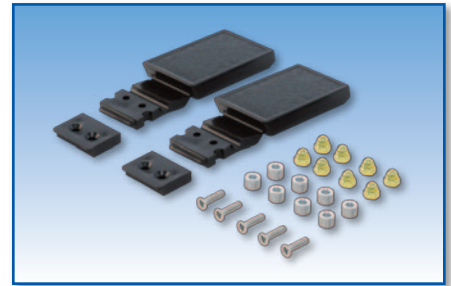

RPI Part #STL055

OEM Part # (No OEM Part # Available)

LATCH

- 2 per package
- Low profile one piece molded polypropylene; Color: Black
- Includes: Latch, keeper, and mounting hardware

Fits: Vacuum Canister Housing and Lid

Models: 986, 987 & 996



RPI Part #STS047

OEM Part # (No OEM Part # Available)

SWITCH

- Rocker switch (On-Off-On)
- 20A @ 125-277VAC; DPDT
- 1/4" tabs
- Panel Cutout: .830" x 1.450", .04" - .25" thk. panel

Fits: Vacuum Canister

Models: 986, 987 & 996



RPI Part #RXG107

OEM Part # (No OEM Part # Available)

GROMMET (3/16" ID X 5/16" GROOVE)

- 4 per package
- Material: Rubber, 55 Duro; Color: Black
- Included in: Motor Kit (RPI Part #STK048)

Fits: Motor Housing

Models: 986, 987 & 996



RPI Part #RXG108

OEM Part # (No OEM Part # Available)

GROMMET (1/4" ID X 11/32" GROOVE)

- 4 per package
- Material: Rubber, 55 Duro; Color: Black

Fits: Vacuum Housing

Models: 986, 987 & 996

rpi Parts to fit Stryker® 900 Series Plaster Vacuums

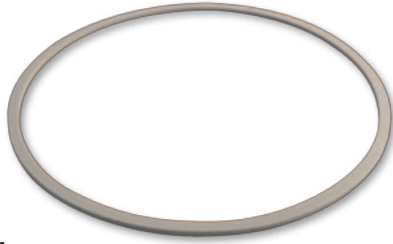

RPI Part #STS054

OEM Part # (No OEM Part # Available)

LID SEAL

- Size: 8.12" ID x 8.62" OD x 1/8" thk.
- Material: Grey closed cell vinyl foam with PSA backing
- Also available: Housing Seal (RPI Part #STS053)

Fits: Chassis

Models: 986, 987 & 996

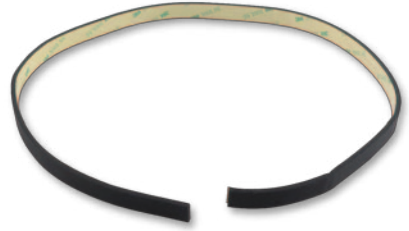

RPI Part #STS053

OEM Part # (No OEM Part # Available)

HOUSING SEAL

- Size: 1/2" wide x 28.0" lg. x 1/8" thk.
- Material: Black closed cell foam with PSA backing
- Includes: Installation template
- Also available: Lid Seal (RPI Part #STS054)

Fits: Chassis

Models: 986, 987 & 996

rpi Parts to fit Stryker® 900 Series Cast Cutters

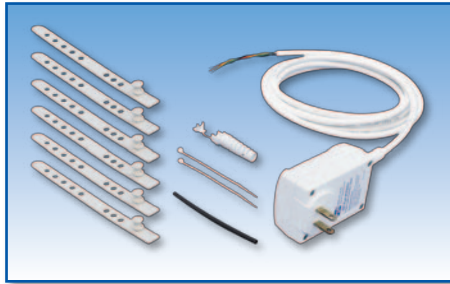

RPI Part #STA057

OEM Part # (No OEM Part # Available)

POWER SUPPLY ASSEMBLY

- Includes: Power Supply PCB (RPI Part #STB039), Power Cable Kit (RPI Part #STK037) and (6 pcs) Cord Strap (White 6") (RPI Part #RPS672)

Fits: Cast Saw Body

Models: 940

For Plaster Casts!



RPI Part #STB043

OEM Part #940-25

CAST CUTTER BLADE

- For plaster casts
- Size: 2.36" oval blade
- Material: Stainless steel
- Color: Silver
- Also available: Blade Guard (RPI Part #STG042)

Fits: Head Assembly

Models: 940 & 941

For Synthetic & Plaster Casts!



RPI Part #STB056

OEM Part #940-23

CAST CUTTER BLADE (PiN)

- For both plaster and synthetic casts
- Size: 2.36" oval blade
- Material: Plasma ion nitride treated stainless steel
- Color: Matte grey
- Also available: Blade Guard (RPI Part #STG042)

Fits: Head Assembly

Models: 940 & 941

For Synthetic & Plaster Casts!



RPI Part #STB045

OEM Part #940-35

CAST CUTTER BLADE (TiN)

- For both plaster and synthetic casts
- Size: 2.36" oval blade
- Material: Titanium nitride coated stainless steel
- Color: Gold
- Also available: Blade Guard (RPI Part #STG042)

Fits: Head Assembly

Models: 940 & 941

BULK STERILIZERS

AMSCO/STERIS

Amscomatic®	200, 202 & 204
Century V116 & V120	200, 203-208
Century V148 & V160	203, 205 & 207
Eagle® Series	200-207 & 209
Medallion® Series	200-207

CASTLE/GETINGE

100 Series	300, 301, 303, 304, 307 & 308
200 Series	303, 304 & 306-308
400/500 Series	300, 301, 303, 304 & 306-308
700 Series	300, 301, 303 & 306-308
800 Series (42" & 76")	303 & 306-308
3522	300-305, 307 & 308
3523	300-305, 307 & 308
3525	300-305, 307 & 308
3533	300-305, 307 & 308
3622	301-307
3623	301, 302, 304 & 306
3633	301-307
4200	302
4200MPS	303, 304, 306 & 307
6300 & 6400 (Washer/Sterilizer)	300
6900 (Sterilizer)	300, 302, 303, 306 & 307
6900AMPS	303, 304 & 307
MC3600	300

WATER-MIZER®

Water-Mizer®	400
--------------	-----

AUTOMATED ENDOSCOPE REPROCESSORS

MINNTECH (MEDIVATORS®)

Advantage Plus®	451-453
CER Optima®	451
DSD Edge®	450-454
DSD-201®	450-454
DSD-91E®	451
SSD-102®	451

STERIS

System 1E®	500-504
System 1® (International Customers only)	500-504

HYDROGEN PEROXIDE STERILIZATION SYSTEMS

STERRAD

100NX	522 & 525-535
100S	523, 525-531, 533 & 534
NX	520, 521, 524 & 526-535

TABLE TOP STERILIZER CLEANING SUPPLIES

PELTON & CRANE (Sterilizer Cleaner & Cleaning Kit)

Sterilizer Cleaner	550
Sterilizer Cleaning Kit	550 & 551

MIDMARK® • RITTER® (Sterilizer Cleaner & Cleaning Kit)

Sterilizer Cleaner	550
Sterilizer Cleaning Kit	550 & 551

SCICAN® (Sterilizer Drying and Rinse Agent & Cleaning Kit)

Sterilizer Drying and Rinse Agent	550
Sterilizer Cleaning Kit	550 & 551

TUTTNAUER® (Sterilizer Cleaner & Cleaning Kit)

Sterilizer Cleaner	550
Sterilizer Cleaning Kit	550 & 551

TABLE TOP STERILIZER TRAYS & RACKS

PELTON & CRANE (Sterilizer Trays & Racks)

Delta AF10	1201
Delta XL10	1201
Delta Q10	1201
OCM®	1215
OCR®	1215
OCR+®	1215
Sentry®	1215
Validator® 10 (AA)	1224
Validator® Plus 10 (AD)	1230

MIDMARK® • RITTER® (Sterilizer Trays & Racks)

Speedclave® M7	1020
Ultraclave® M9	1020
Ultraclave® M9D	1020
Ultraclave® M11	1020
Ultraclave® M11D	1020

TUTTNAUER® (Sterilizer Trays & Racks)

EZ9	1715
EZ9k	1715
EZ10	1715
EZ10k	1715
1730 E Series	1715
2340 E Series	1715
2540 E Series	1715
3870 E Series	1716
1730 M Series	1715
2340 M Series	1715
2540 M Series	1715
3870 M Series	1716
Valueclave (1730MKV)	1715

(continued)

Sterilizers

OEM MODEL Section 10 Page #'s

TABLE TOP STERILIZERS

AMERICAN STERILIZER

Dynaclave® 613R (576A)	600 & 601
Eagle® 10 & 10 Plus	605
Eagle® 900 & 901	604
8816	603
8816A	602
8816D®	601
8816M® (608A®)	601

BARNSTEAD

2250	700 & 701
2251	700 & 701
2260	700 & 701

MDT (HARVEY)

Aquaclave® 10	800, 801 & 803
Aquaclave® 20	800, 801 & 803
Aquaclave® 30	800, 801 & 803
Chemiclave® D	800, 801 & 803
Chemiclave® E	800-803
Chemiclave® 4000	800-803
Chemiclave® 5000	800-803
Chemiclave® 5500	800-803
Chemiclave® 6000	800-803
Chemiclave® 7000	800 & 803
Chemiclave® 8000	800 & 803

MDT • RITTER • CASTLE

GLS8	900 & 903
GLS10	900 & 903
800	900, 901 & 903
800V	900, 901 & 903
1000	900, 901 & 903
1000R	900, 901 & 903
1200	900-903
1250	900-903

MIDMARK® • RITTER®

Speedclave® 7	1000-1005
Speedclave® M7	1000-1005
Ultraclave® M9	1006-1023
Ultraclave® M9D	1006-1023
Ultraclave® M11	1006-1023
Ultraclave® M11D	1006-1023

NATIONAL APPLIANCE

704-7000	1100 & 1101
704-8000	1100 & 1101
704-9000	1100 & 1101

PELTON & CRANE

Delta AE8	1200-1204
Delta XL8	1200-1204
Delta Q8	1200-1204
Delta AF10	1200-1204
Delta XL10	1200-1204
Delta Q10	1200-1204

OEM MODEL Section 10 Page #'s

TABLE TOP STERILIZERS (continued)

PELTON & CRANE (continued)

FL & FL2	1205
GN, HP & HP2	1205
Magnaclave®	1206-1209
OCM®	1210-1219
OCR®	1210-1219
OCR+®	1210-1219
Sentry®	1210-1216, 1218 & 1219
Validator® 8 (AB)	1220-1224
Validator® 10 (AA)	1220-1224
Validator® Plus 8 (AC)	1226-1230
Validator® Plus 10 (AD)	1226-1230

PRESTIGE • KAVO

Kavoclave 2100 Series Old Version I	1300-1305
Kavoclave 2100 Series New Version II	1300-1305
Prestige 2100 Series Old Version I	1300-1305
Prestige 2100 Series New Version II	1300-1305
Prestige 2100 Series Classic Version III	1300-1305

RITTER • CASTLE

F	1400 & 1401
666X	1400 & 1401
777	1400 & 1401
999 Series	1400 & 1401

SCICAN®

Stat/M® 900	1500, 1502, 1504, 1506, 1507 & 1509
Stat/M® 2000	1500-1505
Stat/M® 5000	1500-1505
Stat/M® G4 2000	1500-1505
Stat/M® G4 5000	1500-1505

SPECTROLINE & S.S. WHITE

714	1600 & 1601
750	1600 & 1601

TUTTNAUER®

EZ9	1700, 1702-1706 & 1709-1716
EZ9k	1700, 1702-1706 & 1709-1716
EZ10	1701-1706 & 1709-1716
EZ10k	1701-1706 & 1709-1716
1730 E Series	1700, 1702-1706 & 1709-1716
2340 E Series	1700, 1702-1706 & 1709-1716
2540 E Series	1701-1706 & 1709-1716
3850 E Series	1701-1706, 1709-1714 & 1716
3870 E Series	1701-1706, 1709-1714 & 1716
1730 M Series	1700, 1702-1708, 1712 & 1714-1716
2340 M Series	1700, 1702-1708, 1712 & 1714-1716
2540 M Series	1701-1708, 1712 & 1714-1716
3850 M Series	1701-1708, 1712, 1714 & 1716
3870 M Series	1701-1708, 1712, 1714 & 1716
Valueclave (1730MKV)	1700, 1702-1708, 1712 & 1714-1716

(continued)

Bulk Sterilizers and Sterilizer Washers

Models: Amscomatic, Eagle Series, Century V116, V120, V148 & V160 & Medallion Series

For more details about the models that these parts fit, refer to the RPI website - www.rpiparts.com

RPI Part #AMG007
OEM Part #074366-091

DOOR GASKET

• Size: ~17.89" OD; C/S: .375" Sq.

Fits: 12" x 16"
Rectangular Door
Models: Eagle & Medallion Series



AMG007
CROSS SECTION
SHOWN ACTUAL SIZE

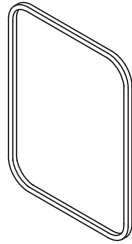

RPI Part #AMG008
OEM Part #074370-091

DOOR GASKET

• Size: ~20.24" OD; C/S: .375" Sq.

Fits: 20"
Round Door
Models: Medallion Series



AMG008
CROSS SECTION
SHOWN ACTUAL SIZE

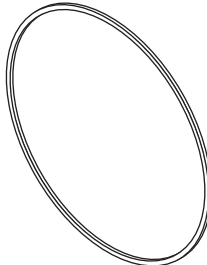

RPI Part #AMG009
OEM Part #074367-091

DOOR GASKET

• Size: ~19.80" OD; C/S: .375" Sq.

Fits: 16" x 16"
Square Door
Models: Eagle & Medallion Series



AMG009
CROSS SECTION
SHOWN ACTUAL SIZE

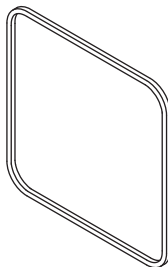

RPI Part #AMG010
OEM Part #078767-091

DOOR GASKET

• Size: ~24.53" OD;
C/S: .375" Sq.

Fits: 20" x 20"
Square Door
Models: Eagle & Medallion Series



AMG010
CROSS SECTION
SHOWN ACTUAL SIZE

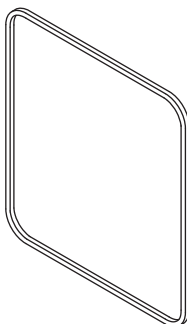

RPI Part #AMG012
OEM Part #097487-091

DOOR GASKET

• Size: ~39.50" OD

Fits: 24" x 36"
Rectangular Door
Models: Eagle & Medallion Series



AMG012
CROSS SECTION
SHOWN ACTUAL SIZE

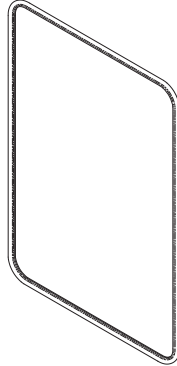

RPI Part #AMK056
OEM Part #075006-091

DOOR GASKET KIT

• Includes all parts as shown

Fits: 24" x 36"
Rectangular Door
Models: Eagle & Medallion Series



AMG012
CROSS SECTION
SHOWN ACTUAL SIZE

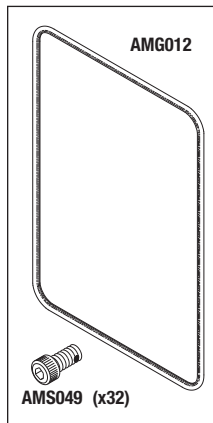

AMS049 (x32)

RPI Part #AMK083
OEM Part #756124-091

DOOR GASKET KIT

• Size: ~29.70" OD

• Includes all parts as shown

Fits: Rectangular Door
Model: Amscomatic



GASKET
CROSS SECTION
SHOWN ACTUAL SIZE

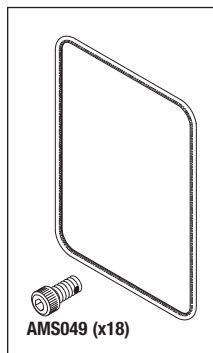

AMS049 (x18)

RPI Part #AMG207
OEM Part #146660-159

DOOR GASKET (16" x 16")

• Size: 16" x 16"

Fits: Chamber Assembly
Model: Century V116



AMG207
CROSS SECTION
SHOWN ACTUAL SIZE

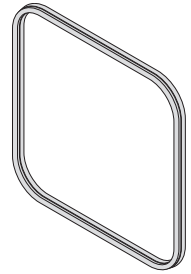

RPI Part #AMG208
OEM Part #146660-160

DOOR GASKET (20" x 20")

• Size: 20" x 20"

Fits: Chamber Assembly
Model: Century V120



AMG208
CROSS SECTION
SHOWN ACTUAL SIZE

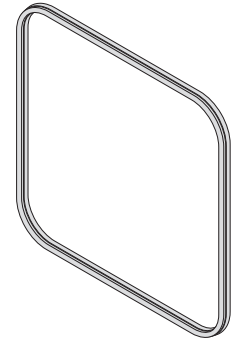

RPI Part #AMG046
OEM Part #090183-091

CHAMBER TRIM GASKET

• Size: 16" x 16"

Fits: Chamber Trim
Models: Amscomatic, Eagle & Medallion Series



AMG046
CROSS SECTION
SHOWN ACTUAL SIZE

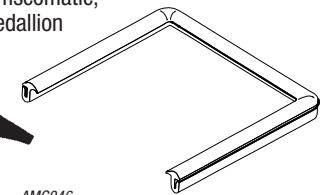

RPI Part #AMG060
OEM Part #090184-091

CHAMBER TRIM GASKET

• Size: 20" x 20"

Fits: Chamber Trim
Models: Eagle Series



AMG060
CROSS SECTION
SHOWN ACTUAL SIZE

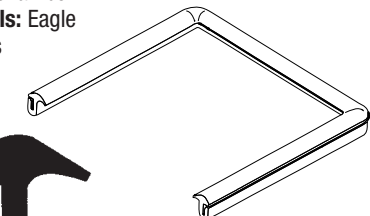

Bulk Sterilizers and Sterilizer Washers

Models: Amscomatic, Eagle Series, Century V116, V120, V148 & V160 & Medallion Series (continued)

For more details about the models that these parts fit, refer to the RPI website - www.rpiparts.com

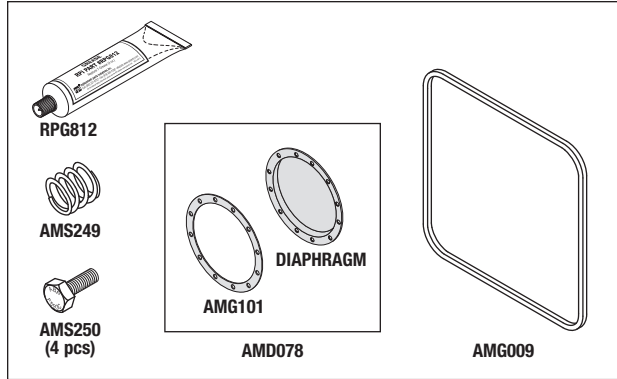

RPI Part #AMP246
OEM Part #754360-002

PM PACK (DOOR, 16")

- Includes all parts as shown

Fits: 16" x 16" Square Door Assembly

Models: All Eagle 2000 (16" x 16"), Eagle 3000 (16" x 16"), Eagle 3000 (Washer/Sterilizer), Medallion (16" x 16") and Medallion (Washer/Sterilizer)

RPI Part #AMG101
OEM Part #007753-091

DIAPHRAGM GASKET

Fits: Snap Action Diaphragm

Models: Eagle & Medallion Series

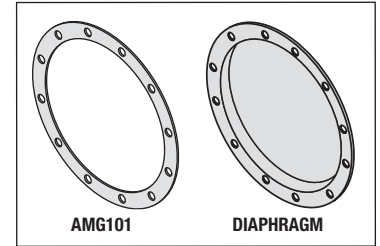
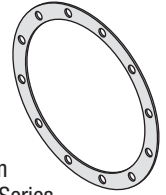

RPI Part #AMD078
OEM Part #007230-061

SNAP ACTION DIAPHRAGM

- Includes all parts as shown

Fits: Door Assembly

Models: Eagle & Medallion Series

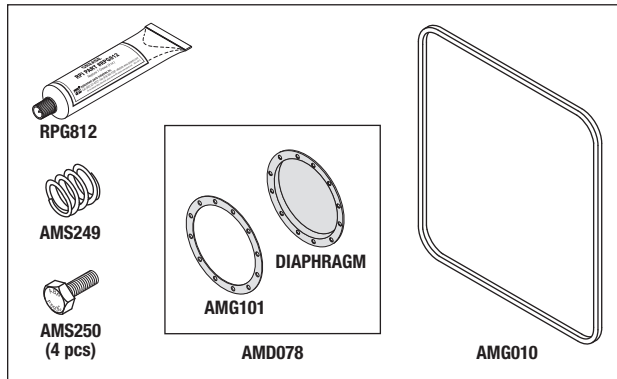

RPI Part #AMP247
OEM Part #754360-003

PM PACK (DOOR, 20")

- Includes all parts as shown

Fits: 20" x 20" Square Door Assembly

Models: All Eagle 2000 (20" x 20"), Eagle 3000 (20" x 20"), Medallion (20"), and Medallion (Small - Vacumatic)

RPI Part #AMS249
OEM Part #12667-061

SPRING (LOCK CLUTCH)

- Material: Stainless steel

• Size: ~.913" OD x 1.000" lg. x .092" wire dia.

Fits: Lock Clutch Assembly, Door Assembly

Models: Eagle & Medallion Series

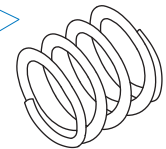

RPI Part #AMS250
OEM Part #4782-061

CAP SCREW

- 4 per package

• 1/4-28 x 5/8" hex head cap screw

• Material: Stainless steel

• Head markings: F593C

Fits: Cover, Snap Action Diaphragm

Models: Eagle & Medallion Series

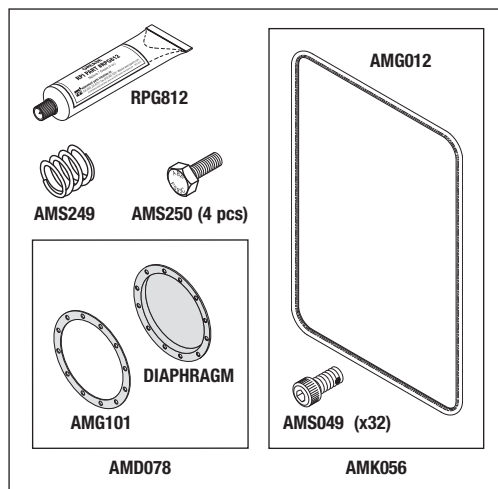
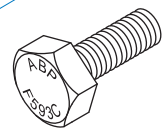

RPI Part #AMP248
OEM Part #764324-196

PM PACK (DOOR, 24" X 36")

- Includes all parts as shown

Fits: 24" x 36" Rectangular Door Assembly

Models: All Eagle 2000 (Medium- Gravity), Eagle 2000 (Medium- Vacumatic), Eagle 3000 (Medium - Gravity), Eagle 3000 (Medium - Vacumatic), Medallion (Medium - Gravity) and Medallion (Medium - Vacumatic)

RPI Part #RPG812
OEM Part #764322-635

GREASE

- Brand name: Neptune 7

• 4 oz. tube; Color: Black

• High Extreme Pressure properties

• High oxidation stability; Water resistant

Models: Eagle & Medallion Series

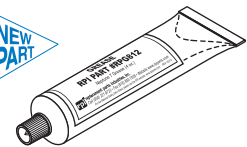

RPI Part #AMS049
OEM Part #046705-061
1/4-28 SOCKET HEAD CAP SCREW WITH NYLON® PELLET

- 25 per package
- Material: Stainless steel
- Size: 1/4-28 x 1/2" lg.
- Fits:** Gasket Bar
- Models:** Amscomatic, Eagle & Medallion Series

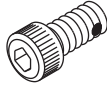

RPI Part #AMS149
OEM Part #090752-091

- DOOR SWITCH**
- 1/2" FPT port
 - Mounts to bracket assembly
 - Models:** Eagle & Medallion Series

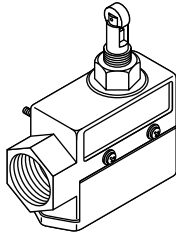

RPI Part #AMK118
OEM Part #056396-215, 093908-907 & 093910-580

- PRESSURE TRANSDUCER KIT**
- Includes all parts as shown
 - Compensated temperature range: 70° F -250° F; Electrical Termination: 10 feet of 4 conductor cable
 - Models:** Eagle 2000 Series Vacumatic, Eagle 3000 Series Stage II Vacumatic, & Eagle 3000 Series Stage III Vacumatic

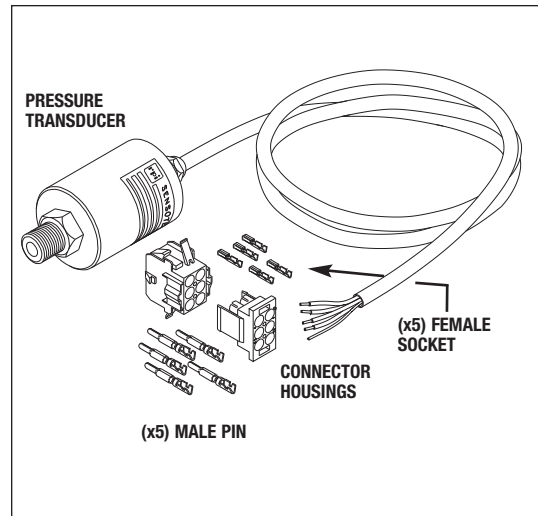

RPI Part #AMA043
OEM Part #025347-091

- 3/8" DISC HOLDER ASSEMBLY**
- Includes all parts as shown
 - Fits:** 3/8" Union Angle Valve
 - Models:** Eagle & Medallion Series

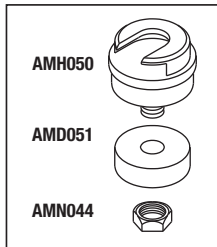

RPI Part #AMA057
OEM Part #A025567-091

- 3/4" DISC HOLDER ASSEMBLY**
- Includes all parts as shown
 - Fits:** 3/4" Union Angle Valve
 - Models:** Eagle & Medallion Series

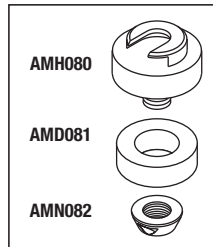

RPI Part #AMB108
OEM Part #096192-091

- BELLOWS (2 INLETS)**
- Material: Brass
 - 1/8" FPT port
 - Fits:** Pressure Switch Assembly
 - Models:** Eagle & Medallion Series

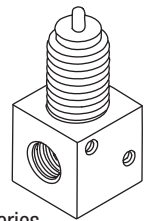

RPI Part #AMB107
OEM Part #096191-091

- BELLOWS (1 INLET)**
- Material: Brass
 - 1/8" FPT port
 - Fits:** Pressure Switch Assembly
 - Models:** Eagle & Medallion Series

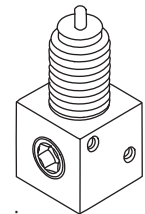

RPI Part #AMH050
OEM Part #150576-001

- 3/8" DISC HOLDER**
- Material: Brass
 - Fits:** 3/8" Union Angle Valve
 - Models:** Eagle & Medallion Series



RPI Part #AMH080
OEM Part #025568-091

- 3/4" DISC HOLDER**
- Material: Brass
 - Fits:** 3/4" Union Angle Valve
 - Models:** Eagle & Medallion Series

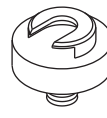

RPI Part #AMD051
OEM Part #025345-091

- 3/8" TEFLON® DISC**
- 5 per package
 - Fits:** Disc Holder Assembly
 - Models:** Eagle & Medallion Series



RPI Part #AMD081
OEM Part #025569-091

- 3/4" TEFLON® DISC**
- Fits:** Disc Holder Assembly
 - Models:** Eagle & Medallion Series



RPI Part #AMA110
OEM Part #096216-091

- PRESSURE SWITCH ASSEMBLY (1 INLET)**
- Includes: Microswitch, mounting bracket, and Bellows Assembly (RPI Part #AMB107)
 - Mounts to Chamber Pressure Gauge
 - Models:** Eagle & Medallion Series

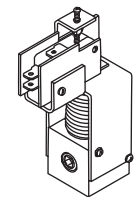

RPI Part #AMA077
OEM Part #096217-091

- PRESSURE SWITCH ASSEMBLY (2 INLETS)**
- Includes: Microswitch, mounting bracket, and Bellows Assembly (RPI Part #AMB108)
 - Mounts to Chamber Pressure Gauge
 - Models:** Eagle & Medallion Series

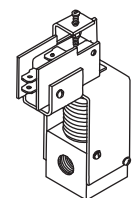

RPI Part #AMN044
OEM Part #056800-091

- HEX NUT**
- 5 per package
 - 1/4-24; Brass
 - Fits:** Disc Holder Assembly
 - Models:** Eagle & Medallion Series



RPI Part #AMN082
OEM Part #002927-091

- "SPECIAL" NUT**
- 3/8-18; Brass
 - Fits:** 3/4" Disc Holder
 - Models:** Eagle & Medallion Series



Bulk Sterilizers and Sterilizer Washers

Models: Amscomatic, Eagle Series, Century V116, V120, V148 & V160 & Medallion Series (continued)

For more details about the models that these parts fit, refer to the RPI website - www.rpiparts.com

RPI Part #AMK085
OEM Part #764073-001

SOLENOID VALVE REPAIR KIT

- For 3/8" port valves
- Includes all parts as shown
- Piston style repair kit

Fits: S-4 valves

Models: Eagle & Medallion Series

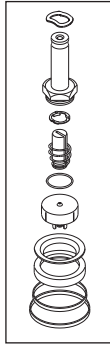

RPI Part #AMK113
OEM Part #764070-001

SOLENOID VALVE REPAIR KIT

- For 3/4" port valves
- Includes all parts as shown
- Diaphragm style repair kit

Fits: S-3 valves

Models: Eagle & Medallion Series

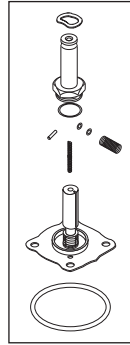

RPI Part #AMK177
OEM Part #764077-001

SOLENOID VALVE REPAIR KIT

- For 3/8" port valves
- Includes all parts as shown
- Piston style repair kit

Fits: S-26 valve

Models: Eagle 3000

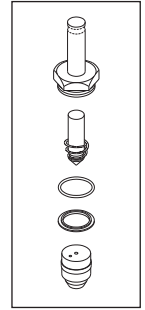

RPI Part #AMK086
OEM Part #764189-001

SOLENOID VALVE REPAIR KIT

- For 1-1/4" port valves
- Includes all parts as shown
- Piston/Diaphragm style repair kit

Fits: V-23 chamber drain, S-10 valves

Models: Eagle & Medallion Series

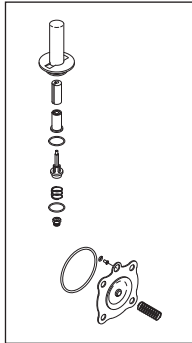

RPI Part #AMK174
OEM Part #764072-001

SOLENOID VALVE REPAIR KIT

- For 3/4" port valves
- Includes all parts as shown
- Diaphragm style repair kit

Fits: Valve (see Models below)

Models: Century V148 & V160: S-4; Eagle 2000 & 3000: S-4 and S-7

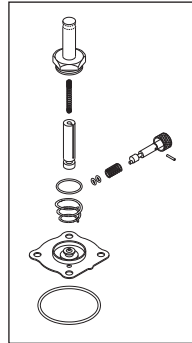

RPI Part #AMK181
OEM Part #764078-001

SOLENOID VALVE REPAIR KIT

- For 3/4" port valves
- Includes all parts as shown
- Diaphragm style repair kit

Fits: S-1 valve

Models: Eagle 2000 & 3000

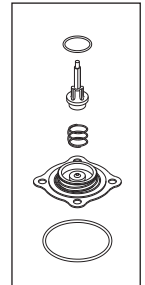

RPI Part #AMK087
OEM Part #764317-688

SOLENOID VALVE REPAIR KIT

- For 1" port valves
- Includes all parts as shown
- Piston style repair kit

Fits: Valve (see Models below)

Models: Century V148 & V160: S-2; Eagle & Medallion Series: S-2 & S-9

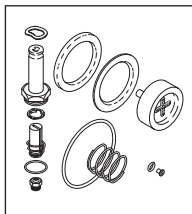

RPI Part #AMK175
OEM Part #764075-001

SOLENOID VALVE REPAIR KIT

- For 1/4" port valves
- Includes all parts as shown
- Piston style repair kit

Fits: S-23 valve

Models: Eagle 2000 & 3000

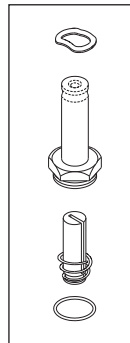

RPI Part #AMK182
OEM Part #764079-001

SOLENOID VALVE REPAIR KIT

- For 1/4" port valves
- Includes all parts as shown
- Piston style repair kit

Fits: S-12 valve

Models: Eagle 2000

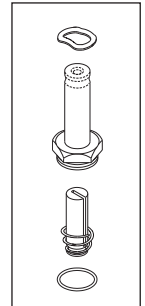

RPI Part #AMK089
OEM Part #764317-687

SOLENOID VALVE REPAIR KIT

- For 3/8" port valves
- Includes all parts as shown
- Piston style repair kit

Fits: S-2 valves

Models: Eagle & Medallion Series

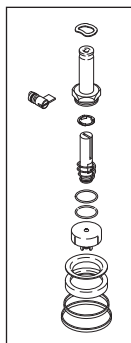

RPI Part #AMK176
OEM Part #764076-001/764326-479

SOLENOID VALVE REPAIR KIT

- For 1/4" port valves
- Includes all parts as shown
- Piston style repair kit

Fits: Steam Manifold/Exhaust Manifold/Valve (see Models below)

Models: Century V148 & V160: S-7; Eagle 2000 & 3000: S-12 and S-14 valves

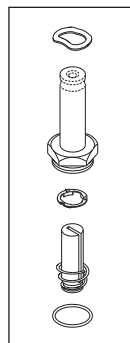

RPI Part #AMK183
OEM Part #764187-001 & 764326-482

SOLENOID VALVE REPAIR KIT

- for 3/8" port valves
- Includes all parts as shown
- Diaphragm style repair kit

Fits: Exhaust Manifold/Valve (see Models below)

Models: Century V116 & V120: S-3; Eagle 2000: S-26

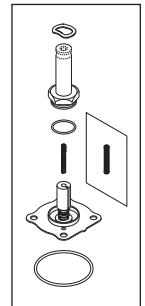

RPI Part #CSK050
OEM Part # (No OEM Part # Available)

SOLENOID VALVE REPAIR KIT

- Includes all parts as shown
- Diaphragm style repair kit

Fits: S-4 & S-7 valve

Models: Century V116 & V120

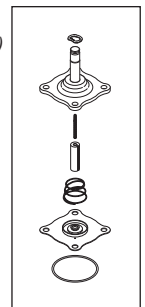

Bulk Sterilizers and Sterilizer Washers

Models: Amscomatic, Eagle Series, Century V116, V120, V148 & V160 & Medallion Series (continued)

For more details about the models that these parts fit, refer to the RPI website - www.rpiparts.com

RPI Part #AMK111
OEM Part #754359-001

3/8" PRV KIT
 • Includes all parts as shown
Fits: (see Models below)
Models: Century V116 & V120: PM for PR1; Eagle & Medallion Series: 3/8" Supply Valve

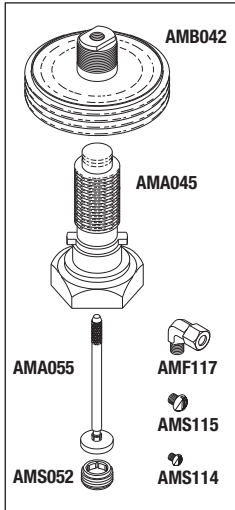

RPI Part #AMK112
OEM Part #754359-003

3/4" PRV KIT
 • Includes all parts as shown
Fits: 3/4" Supply Valve
Models: Eagle & Medallion Series

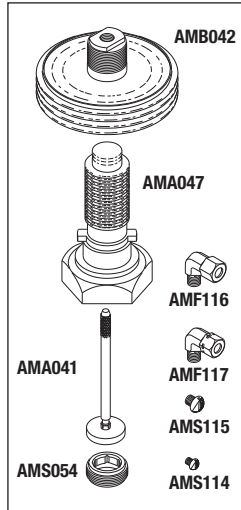

RPI Part #AMV094
OEM Part #58695

SOLENOID VALVE REPAIR KIT
 • For 3/4" port valves
 • Includes all parts as shown
 • Piston style repair kit
Fits: 3/4" Piston Valve
Models: Eagle Series

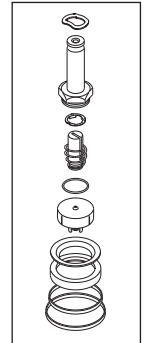

RPI Part #AMB042
OEM Part #035880-091

BELLOWS
Fits: Steam Control Valve
Models: Amscomatic; Century V116 & V120: PM for PR1; Eagle & Medallion Series

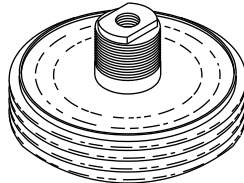

RPI Part #AMF116
OEM Part #042510-091

ELBOW (1/4 x 1/8 MPT)
 • Size: 1/4" Tube x 1/8" MPT
 • Material: Brass
Fits: Steam Control Bellows
Models: Eagle & Medallion Series

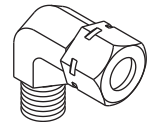

RPI Part #AMF117
OEM Part #006750-044

ELBOW (5/16 x 1/8 MPT)
 • Size: 5/16" Tube x 1/8" MPT
 • Material: Brass
Fits: Steam Control Bellows
Models: Century V116 & V120: PM for PR1; Eagle & Medallion Series

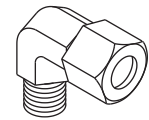

RPI Part #AMA045
OEM Part #026836-091

3/8" BONNET & SYLPHON ASSEMBLY
Fits: Steam Control Valve
Models: Century V116 & V120: PM for PR1; Eagle & Medallion Series

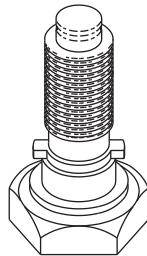

RPI Part #AMA047
OEM Part #026837-091

3/4" BONNET & SYLPHON ASSEMBLY
Fits: Steam Control Valve
Models: Eagle & Medallion Series

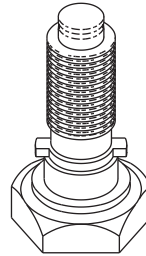

RPI Part #AMS052
OEM Part #005685-061

3/8" VALVE SEAT
Fits: Union Angle Valve
Models: Century V116 & V120: PM for PR1; Eagle & Medallion Series



RPI Part #AMS054
OEM Part #022425-061

3/4" VALVE SEAT
Fits: 3/4" Angle Valve
Models: Eagle & Medallion Series

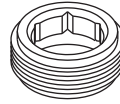

RPI Part #AMS114
OEM Part #009276-041

SCREW (#8-32 x 3/16)
 • 25 per package
 • Material: Stainless steel
 • Round Head Slot
Fits: Cover Assembly in Steam Control Valve
Models: Century V116 & V120: PM for PR1; Eagle & Medallion Series



RPI Part #AMA055
OEM Part #028267-091

3/8" VALVE STEM ASSEMBLY
Fits: 3/8" and 1/2" Steam Control Valves
Models: Century V116 & V120: PM for PR1; Eagle & Medallion Series

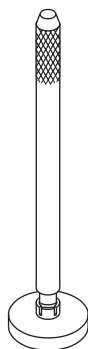

RPI Part #AMA041
OEM Part #028265-091

3/4" VALVE STEM ASSEMBLY
Fits: 3/4" Steam Control Valves
Models: Eagle & Medallion Series

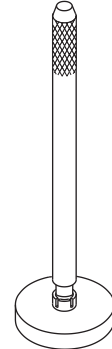

RPI Part #AMS115
OEM Part #003969-041

SCREW (#8-32 x 1/4)
 • 25 per package
 • Material: Stainless steel
 • Round Head Slot
Fits: Cover Assembly in Steam Control Valve
Models: Century V116 & V120: PM for PR1; Eagle & Medallion Series



Bulk Sterilizers and Sterilizer Washers

Models: Amscomatic, Eagle Series, Century V116, V120, V148 & V160 & Medallion Series (continued)

For more details about the models that these parts fit, refer to the RPI website - www.rpiparts.com

RPI Part #AMV191
OEM Part #150828-473

SAFETY VALVE (40 PSI)

- 1/2" MPT x 3/4" FPT
- Material: Brass body; Teflon® seat
- Cracking Pressure: 40 PSI

Fits: Jacket

Models: Eagle 2000 general purpose, small isothermal, small vac and medium ETO; Eagle 3000 Stage II general purpose and medium vac; and, Eagle 2000 Stage III general purpose and small vac

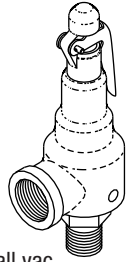

RPI Part #AMV263
OEM Part #150828-476

SAFETY VALVE (40 PSI)

- 3/4" MPT x 1" FPT
- Material: Bronze body; Viton seat
- Cracking Pressure: 40 PSI

Fits: Chamber Jacket

Models: Eagle 2000 & 3000

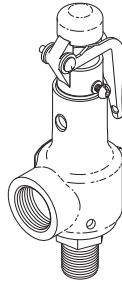

RPI Part #CSV086
OEM Part #150828-478

SAFETY VALVE (40 PSI)

- 1" MPT x 1-1/4" FPT
- Material: Bronze body; EP seat
- Cracking Pressure: 40 PSI

Fits: Chamber Jacket

Models: Eagle 3000

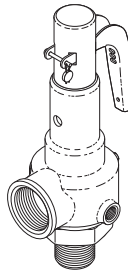

RPI Part #AMV201
OEM Part #93918-013

SAFETY VALVE (50 PSI)

- 1/2" MPT x 3/4" FPT
- Material: Brass body; EP seat
- Cracking Pressure: 50 PSI

Fits: Chamber Assembly

Models: Century V116 & V120

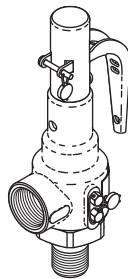

RPI Part #AMV150
OEM Part #764323-459 & 075421-091

SAFETY VALVE (100 PSI)

- 1/2" MPT x 1" FPT
- Material: Bronze body; Teflon® seat
- Cracking Pressure: 100 PSI

Fits: Electro Steam Generator

Models: Eagle & Medallion Series

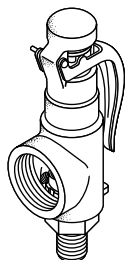

RPI Part #AMT187
OEM Part #129222-001

STEAM TRAP ASSEMBLY

- 1/2" MPT port
- Includes all parts as shown

Fits: Jacket Drain Assembly

Models:

All Eagle 2000 & 3000 and All Medallion Series (Jacket drain assembly); Century V148 & V160 (Jacket & Chamber Drain); Century V116 & V120 (1/2" Steam Trap)

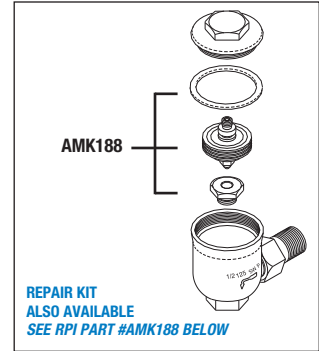

REPAIR KIT
ALSO AVAILABLE
SEE RPI PART #AMK188 BELOW

RPI Part #AMK188
OEM Part #764080-001

STEAM TRAP ASSEMBLY REPAIR KIT

- For 1/2" MPT port steam trap
- Includes all parts as shown

Fits: Steam Trap

Models: All Eagle 2000 & 3000 and All Medallion Series; Century V148 & V160; Century V116 & V120 (Kit for 1/2" Steam Trap)

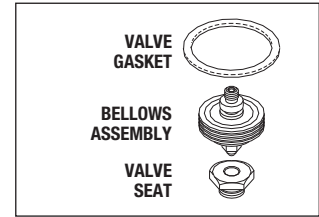

RPI Part #AMG244
OEM Part #7871-051

PRESSURE GAUGE (JACKET)

- 2.5" Dial
- Scale: 30 in. Hg Vac to 0 PSI (unmarked) and 0 – 100 PSI (marked)
- Dial face: White with black characters
- 1/8" MPT bottom mount
- Zero adjustment

Fits: Jacket

Models: Century Medium V116 and V120



RPI Part #AMG245
OEM Part #7872-051

PRESSURE GAUGE (CHAMBER)

- 2.5" Dial
- Scale: 30 in. Hg Vac to 0 PSI (marked) and 0 – 100 PSI (unmarked)
- Dial face: White with black characters
- 1/8" MPT bottom mount
- Zero adjustment

Fits: Chamber

Models: Century Medium V116 and V120

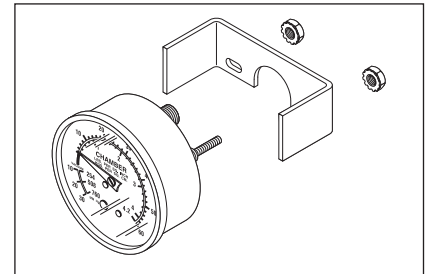
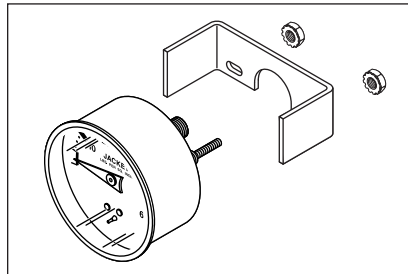
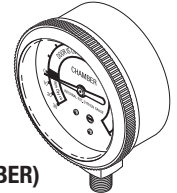

RPI Part #AMG135
OEM Part #090730-091

PRESSURE GAUGE (JACKET)

- 2.5" Dial
- 0-60 PSIG
- Center back mount, 1/8" MPT
- Gauge has zero adjust pointer
- Reads jacket pressure
- Includes: Gauge, mounting bracket, and hardware

Fits: Front Control Panel

Models: Eagle & Medallion Series

RPI Part #AMG134

OEM Part #090525-091

PRESSURE/VACUUM GAUGE (CHAMBER)

- 2.5" Dial
- Dual scale: 0-60 PSIG/10-30 PSIG & 0-4.2 kgs. sq. cm/254-760mm Hg.
- Center back mount, 1/8" MPT
- Gauge has zero adjust pointer
- Reads Chamber Pressure/Vacuum
- Includes: Gauge, mounting bracket, and hardware

Fits: Front Control Panel

Models: Eagle & Medallion Series

Bulk Sterilizers and Sterilizer Washers

Models: Amscomatic, Eagle Series, Century V116, V120, V148 & V160 & Medallion Series (continued)

For more details about the models that these parts fit, refer to the RPI website - www.rpiparts.com

RPI Part #AMG152
OEM Part #754031-091

CLEAR SIGHT GLASS
• Size: 5/8" OD x 8" lg.
• Includes all parts as shown
Fits: Electro Steam Generator
Models: Eagle & Medallion Series

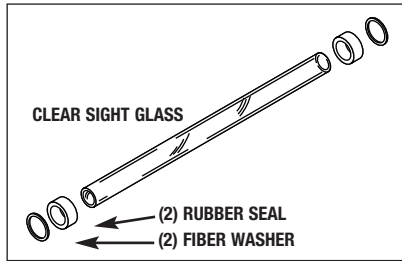

RPI Part #AMC153
OEM Part #761847-001

SIGHT GLASS COLLAR
Fits: Sight Glass Assembly
Models: Eagle & Medallion Series



RPI Part #AMF138
OEM Part #764317-836

PICO FUSE (1/2A, 125VAC)
• 5 per package
Fits: Main Control Assembly
Models: Eagle & Medallion Series

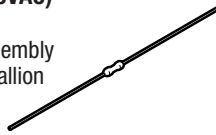

RPI Part #AMF139
OEM Part #764317-835

PICO FUSE (3A, 125VAC)
• 5 per package
Fits: Main Control Assembly
Models: Eagle & Medallion Series

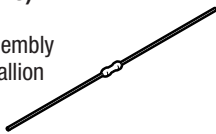

RPI Part #AMF141
OEM Part #764317-833

PICO FUSE (2A, 125VAC)
• 5 per package
Fits: Main Control Assembly
Models: Eagle & Medallion Series

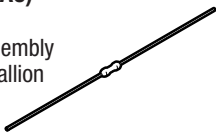

RPI Part #AMF142
OEM Part #764317-834

PICO FUSE (4A, 125VAC)
• 5 per package
Fits: Main Control Assembly
Models: Eagle & Medallion Series

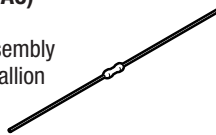

RPI Part #AMK155
OEM Part #
(No OEM Part # Available)

MULTIPORT VALVE KIT
• Includes all parts as shown
Fits: Medallion Series

All parts in Kit also sold separately

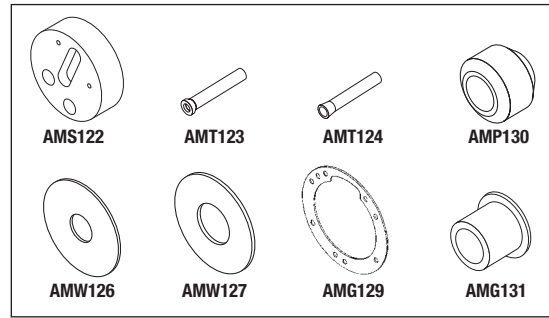

RPI Part #AMS122
OEM Part #020556-091

VALVE SEAT (MULTIPORT VALVE)
Models: Medallion Series

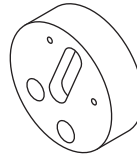

RPI Part #AMT123
OEM Part #091065-091

CHOKER TUBE
Fits: Multiport Valve Seat
Models: Medallion Series



RPI Part #AMT124
OEM Part #030096-091

CHOKER TUBE
Fits: Multiport Valve Seat
Models: Medallion Series



RPI Part #AMW126
OEM Part #008375-091

BRASS WASHER
• 6 per package
• .415" ID x 1.500" OD x .065" THK
Fits: Stem in Multiport Valve
Model: Medallion Series



RPI Part #AMW127
OEM Part #010414-042

BRASS WASHER
• 6 per package
• .400" ID x .870" OD x .032" THK
Fits: Stem in Multiport Valve
Model: Medallion Series



RPI Part #AMG131
OEM Part #007755-042

GLAND
Fits: Multiport Valve
Model: Medallion Series

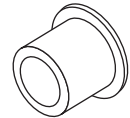

RPI Part #AMG129
OEM Part #007849-091

GASKET
• 6 per package
Fits: Multiport Valve
Model: Medallion Series

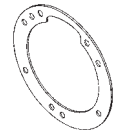

RPI Part #AMP130
OEM Part #008784-091

TEFLON® PACKING
Fits: Stem in Multiport Valve
Models: Medallion Series

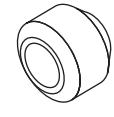

RPI Part #AMS125
OEM Part #P090136-061

DUAL OFFSET SHAFT
• Material: Stainless steel
Fits: Multiport Valve
Models: Medallion Series

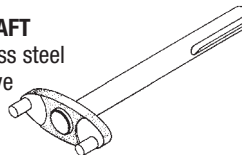

RPI Part #AMS128
OEM Part #012349-061

SPRING
• Size: 1.40" OD x 1.31" lg.
x .156" Wire; Material: Stainless steel
Fits: Multiport Valve
Models: Medallion Series

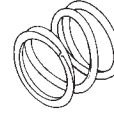

RPI Part #RPF050
OEM Part #764317-825

FUSE (4A, 250V) - FAST ACTING
• 5 per package
• Type: Glass; Size: 1/4" dia. x 1-1/4" lg.
Fits: F1, F2 Fuse
Models: Century V116 & V120

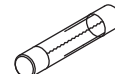

RPI Part #RPF067
OEM Part #764317-463

FUSE (5A, 250V) - TIME DELAY
• 5 per package
• Type: Glass; Size: 1/4" dia. x 1-1/4" lg.
Fits: F3 Fuse (V116 & V120)
Models: Century V116, V120, V148 & V160

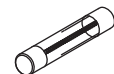

RPI Part #RPT113
OEM Part # *(No OEM Part # Available)*

MAX REGISTER THERMOMETER
• Mercury; Size: ~.40" OD x ~6.63" lg.
• Accuracy Rating: ±1 Division (±2°F);
Dual Scale: 150°F to 350°F (65°C to 177°C)

Includes: Thermometer and Protective Metal Case

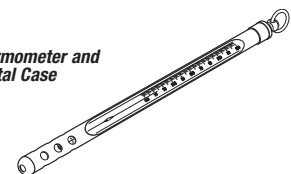

Bulk Sterilizers and Sterilizer Washers

Models: Amscomatic, Eagle Series, Century V116, V120, V148 & V160 & Medallion Series (continued)

For more details about the models that these parts fit, refer to the RPI website - www.rpiparts.com

RPI Part #AMP214
OEM Part #764326-646

PM PACK (MISCELLANEOUS)

- Includes:
 - (1) Check Valve (1/4") (RPI Part #AMV228);
 - (1) Filter Element (RPI Part #AME200);
 - (2) Steam Trap Repair Kit (RPI Part #AMK188);
 - (3) Check Valve (1/2") (RPI Part #AMV229);
 - (1 pkg of 5) Fuse (5A, 250V) - Time Delay (RPI Part #RPF067); and
 - (1 pkg of 5) Fuse (4A, 250V) - Fast Acting (RPI Part #RPF050)

All parts also sold separately

Models: Century V116 & V120

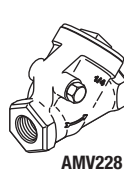

AMV228

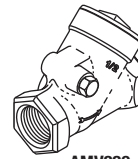

AMV229



RPF067



RPF050



AME200

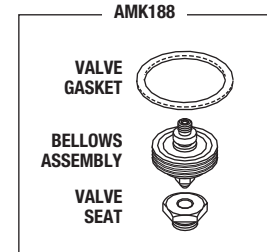

RPI Part #AMV228
OEM Part #10278-091

CHECK VALVE (1/4")

- CK14
- 1/4" FPT inlet & outlet
- Also Available: Check Valve Rebuild Kit (RPI Part #AMK230)

Note: CK14 is plumbed in line with Exhaust Manifold

Models: Century V116 & V120

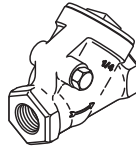

RPI Part #AMV229
OEM Part #150822-354

CHECK VALVE (1/2")

- CK1, CK2 & CK3
- 1/2" FPT inlet & outlet
- Also Available: Check Valve Rebuild Kit (RPI Part #AMK231)

Note: CK1 & CK2 are plumbed between Water Ejector and Waste Funnel; and, CK3 is plumbed between TR-2 Steam Trap and CK14 Check Valve

Models: Century V116 & V120

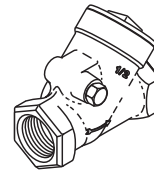

RPI Part #AME200
OEM Part #129360-802

FILTER ELEMENT

- Size: 1.40" OD x 2.50" lg.
- Fits: Air Filter Housing

Models: Century V116 & V120

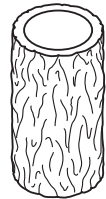

It's the **rpi** Advantage!®

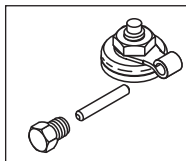

RPI Part #AMK230
OEM Part #10278-091 (Complete Check Valve)

CHECK VALVE REBUILD KIT (1/4")

- PTFE Seat Disc (White)
- Includes all parts as shown
- Also Available: Check Valve (1/4") (RPI Part #AMV228)
- With RPI's Check Valve Rebuild Kit, now you have the option to rebuild or replace the Check Valve - It's the RPI Advantage!

Fits: Check Valve (1/4") / CK14

Models: Century V116 & V120

It's the **rpi** Advantage!®

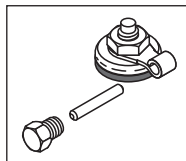

RPI Part #AMK231
OEM Part #764319-608 (Disc only)

CHECK VALVE REBUILD KIT (1/2")

- Buna-N Seat Disc (Black)
- Includes all parts as shown
- Also Available: Check Valve (1/2") (RPI Part #AMV229)
- RPI not only includes the Disc, but we also supply the Pin and Plug - It's the RPI Advantage!

Fits: Check Valve (1/2") / CK1, CK2 & CK3

Models: Century V116 & V120

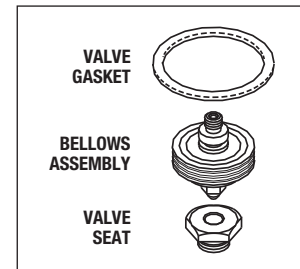

RPI Part #AMK188
OEM Part #764080-001

STEAM TRAP REPAIR KIT

- For 1/2" MPT port steam trap
- Includes all parts as shown
- Also available: Steam Trap Assembly (RPI Part #AMT187)

Fits: Steam Trap

Models: All Eagle 2000 & 3000 & All Medallion Series; Century V116, V120, V148 & V160

RPI Part #RPF050
OEM Part #764317-825

FUSE (4A, 250V) - FAST ACTING

- 5 per package
- Type: Glass; Size: 1/4" dia. x 1-1/4" lg.
- Fits: Power Supply F1 and F2 Fuse

Models: Century V116 & V120

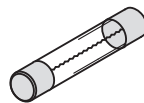

RPI Part #RPF067
OEM Part #764317-463

FUSE (5A, 250V) - TIME DELAY

- 5 per package
- Type: Glass; Size: 1/4" dia. x 1-1/4" lg.
- Fits: Control Box F3 Fuse

Models: Century V116, V120, V148 & V160

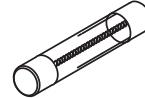

Bulk Sterilizers and Sterilizer Washers

Models: Amscomatic, Eagle Series, Century V116, V120, V148 & V160 & Medallion Series (continued)

For more details about the models that these parts fit, refer to the RPI website - www.rpiparts.com

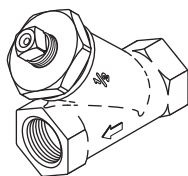

RPI Part #AMS202
OEM Part #150828-459

STRAINER (1/2")

- 1/2" FPT Inlet and Outlet
- Includes: Strainer Element (1/2") (RPI Part #AMK232)

Fits: Plumbed in line with TR-2 Steam Trap

Models: Century V116 & V120

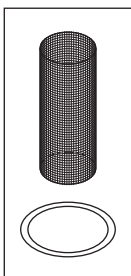

RPI Part #AMK232
OEM Part #764326-663
(Strainer) & **764326-727** (O-Ring)

STRAINER ELEMENT (1/2")

- Size: .62" OD x 1.64" lg.
- 80 Mesh stainless steel screen with PTFE O-ring
- Also Available: Strainer (1/2") (RPI Part #AMS202)

Fits: Strainer (1/2")

Models: Century V116 & V120

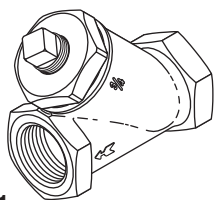

RPI Part #AMS203
OEM Part #47708-091

STRAINER (3/4")

- 3/4" FPT Inlet and Outlet
- Includes: Strainer Element (3/4") (RPI Part #AME233)

Fits: Plumbed in line between Water Manifold and M1 Ball Valve

Models: Century V116 & V120

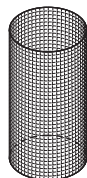

RPI Part #AME233
OEM Part #764326-673

STRAINER ELEMENT (3/4")

- Size: .88" OD x 1.76" lg.
- 24 Mesh stainless steel screen
- Also Available: Strainer (3/4") (RPI Part #AMS203)

Fits: Strainer (3/4")

Models: Century V116 & V120



RPI Part #AMS204
OEM Part #093918-035

SCREEN, CHAMBER DRAIN

- Material: Stainless steel

Fits: Drain Line

Models: Century V116 & V120

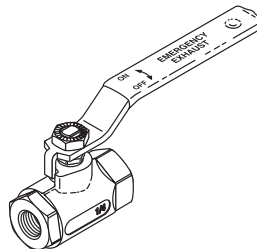

RPI Part #AMV205
OEM Part #93918-212

BALL VALVE (1/4")

- Red "Emergency Exhaust" handle
- 1/4" FPT Inlet and Outlet

Fits: Mounted above Chamber Door

Models: Century V116 & V120

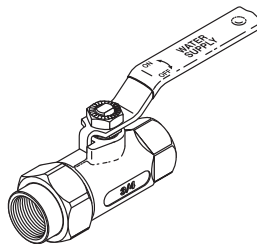

RPI Part #AMV206
OEM Part #93918-066

BALL VALVE (3/4")

- Blue "Water Supply" handle
- 3/4" FPT Inlet and Outlet

Fits: Mounted below Chamber Door

Models: Century V116 & V120

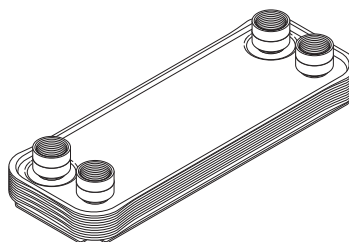

RPI Part #AMX218
OEM Part #136809-711, 136809-844, 764328-456 (16" Kit with Plumbing) & **764328-457** (20" Kit with Plumbing)

HEAT EXCHANGER

- ~12.20" x 4.37" x 1.30"

• Rated for up to 450 PSI and 437°F steam

Models: Century V116 & V120



RPI Part #AMK215
OEM Part #764326-476

SEAT KIT (STEAM)

- Material: Stainless steel seats and EP O-rings
- Includes: .218" seat, .375" seat, (2) .625" seats, (1 pc) O-ring (RPI Part #RP0439) & (2 pcs) O-ring (RPI Part #RP0444)

Fits: Steam Manifold

Models: Century V116 & V120

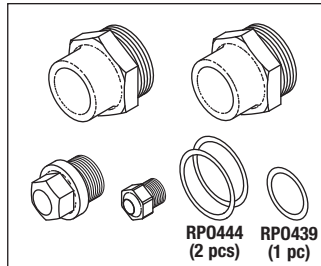

RPI Part #AMK216
OEM Part #764326-481

SEAT KIT (EXHAUST)

- Material: Stainless steel seats and EP O-rings
- Includes: .094" seat, .109" seat, .750" short seat, .750" long seat, (2) .218" seats & (2 pcs) O-ring (RPI Part #RP0444)

Fits: Exhaust Manifold

Models: Century V116 & V120

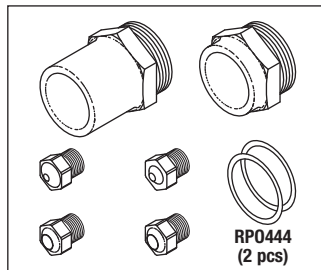

RPI Part #AMK217
OEM Part #764326-620

SEAT KIT (WATER)

- Material: Stainless steel seats and EP O-rings
- Includes: .750" short seat, (2) .750" long seats & (3 pcs) O-ring (RPI Part #RP0444)

Fits: Water Manifold

Models: Century V116 & V120

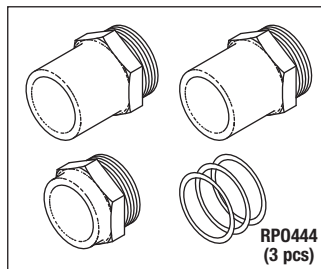

New PM Packs
and more to fit

AMSCO/STERIS®

Century V116, V120, V136, V148 & V160 Sterilizers!



RPI Part #AMP212
OEM Part #764326-480

PM PACK (EXHAUST MANIFOLD)

- Includes: S3 Solenoid Valve Repair Kit For 3/8" Port Valves (RPI Part #AMK183), S40 Solenoid Valve Repair Kit (RPI Part #AMK223), S37 Solenoid Valve Repair Kit (RPI Part #AMK221), CK4 and CK6/FC2 Control Valve & Flow Control Kit (RPI Part #AMK225), TR1 Steam Trap Repair Kit (RPI Part #AMK188), and CK8 Check Valve Repair Kit (RPI Part #AMK227)

- Also available: Seat Kit (Exhaust) (RPI Part #AMK216)

Fits: Exhaust Manifold

Models: Century V116 & V120

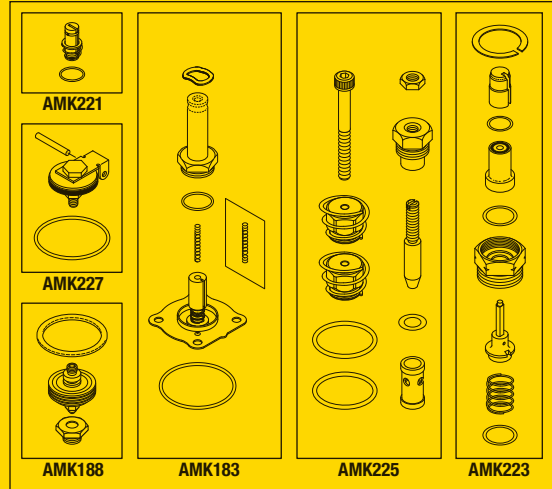

RPI Part #AMP211
OEM Part #764326-475

PM PACK (STEAM MANIFOLD)

- Includes: S1 Solenoid Valve Repair Kit (RPI Part #AMK219), (2) S2 and S9 Solenoid Valve Repair Kit (RPI Part #AMK220), and S35 Solenoid Valve Repair Kit (RPI Part #AMK221)

- Also available: Seat Kit (Steam) (RPI Part #AMK215)

Fits: Steam Manifold

Models: Century V116 & V120

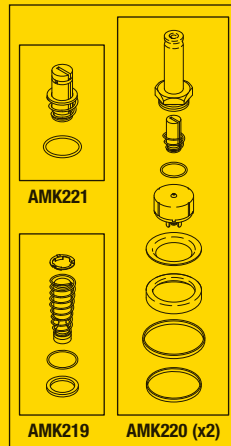

RPI Part #AMP209
OEM Part #764326-486

PM PACK (DOUBLE DOOR MANIFOLD)

- Includes: S38 Solenoid Valve Repair Kit (RPI Part #AMK221) and CK7/FC3 Check Valve & Flow Control Kit (RPI Part #AMK225)

- Also available: Seat Kit (Double Door) (RPI Part #AMK210)

Fits: Double Door Manifold

Models: Century V116 & V120

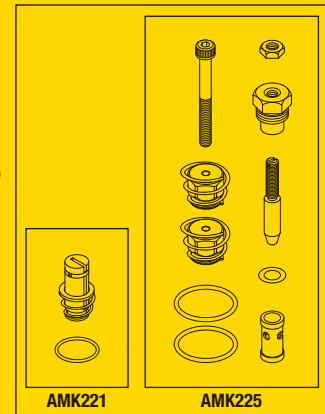

RPI Part #AMP213
OEM Part #764326-619

PM PACK (WATER MANIFOLD)

- Includes: (2) S4 and S7 Solenoid Valve Repair Kit (RPI Part #CSK050) and CK5 Check Valve Repair Kit (RPI Part #AMK227)

- Also available: Seat Kit (Water) (RPI Part #AMK217)

Fits: Water Manifold

Models: Century V116 & V120

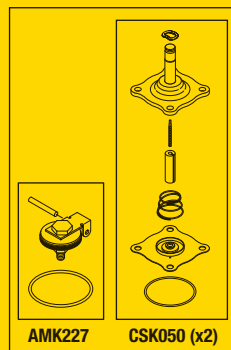

RPI Part #AMP214
OEM Part #764326-646

PM PACK (MISCELLANEOUS)

- Includes: Check Valve (1/4") (RPI Part #AMV228), Filter Element (RPI Part #AME200), (2) Steam Trap Repair Kit (RPI Part #AMK188), (3) Check Valve (1/2") (RPI Part #AMV229), (1 pkg of 5) (5A 240V) – Time Delay (RPI Part #RPF067), and (1 pkg of 5) (4A, 250v) – Fast Acting (RPI Part #RPF050)

Models: Century V116 & V120

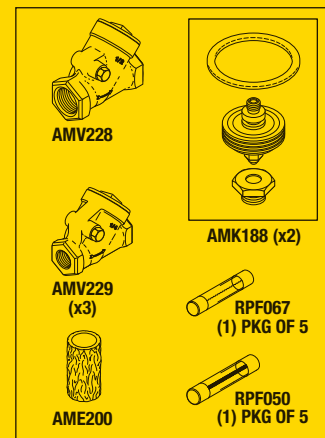

replacement parts industries, inc.

CALL (800) 221-9723 • FAX (818) 882-7028 • EMAIL order@riparts.com • WEBSITE www.riparts.com

The above parts are manufactured by Replacement Parts Industries, Inc. to fit the equipment noted. All product names used in this document are trademarks or registered trademarks of their respective holders. 1904AM Show 05/21



RPI Part #AMK210
OEM Part #764326-487

SEAT KIT (DOUBLE DOOR)

- Material: Stainless steel and EPDM O-Rings
- Includes: S38 .218" seat, CK7 .109" seat, and (2 pcs) O-Ring (RPI Part #RPO490)
- Fits:** Double Door Manifold
- Models:** Century V116 & V120

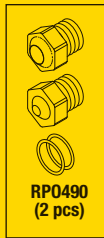

RPI Part #AMK219
OEM Part #764326-477

SOLENOID VALVE REPAIR KIT

- Seal material: EPDM
- Includes all parts as shown
- Included In: PM Pack (Steam Manifold) (RPI Part #AMP211)
- Also available: Seat Kit (Steam) (RPI Part #AMK215)
- Fits:** Steam Manifold S1
- Models:** Century V116 & V120

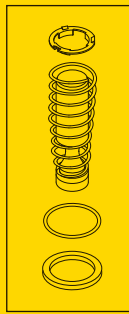

RPI Part #AMK221
OEM Part #764326-479

SOLENOID VALVE REPAIR KIT

- Seal Material: EPDM
- Includes all parts as shown
- Included In: PM Pack (Steam Manifold) (RPI Part #AMP211), PM Pack (Exhaust Manifold) (RPI Part #AMP212), and PM Pack (Double Door Manifold) (RPI Part #AMP209)
- Also available: Seat Kit (Steam) (RPI Part #AMK215), Seat Kit (Exhaust) (RPI Part #AMK216) and Seat Kit (Double Door) (RPI Part #AMK210)

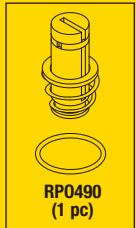

Fits: Exhaust Manifold S37, Steam Manifold S35 and Double Door Manifold S38
Models: Century V116 & V120

RPI Part #AMK215
OEM Part #764326-476

SEAT KIT (STEAM)

- Material: Stainless steel seats and EPDM O-Rings
- Includes: S35 .218" seat, S1 .375" seat, (2) S2 and S9 .625" seats, (1 pc) O-Ring (RPI Part #RPO439), and (2 pcs) O-Ring (RPI Part #RPO444)
- Fits:** Steam Manifold
- Models:** Century V116 & V120

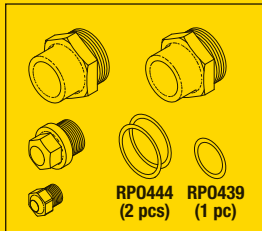

RPI Part #AMK220
OEM Part #764326-478

SOLENOID VALVE REPAIR KIT

- Seal material: EPDM
- Includes all parts as shown
- Included In: PM Pack (Steam Manifold) (RPI Part #AMP211)
- Also available: Seat Kit (Steam Manifold) (RPI Part #AMK215)
- Fits:** Steam Manifold S2 and S9
- Models:** Century V116 & V120

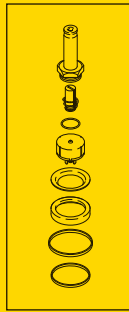

RPI Part #AMK223
OEM Part #764326-483

SOLENOID VALVE REPAIR KIT

- Seal material: EPDM
- Includes all parts as shown
- Included In: PM Pack (Exhaust Manifold) (RPI Part #AMP212)
- Also available: Seat Kit (Exhaust) (RPI Part #AMK216)
- Fits:** Exhaust Manifold S40
- Models:** Century V116 & V120

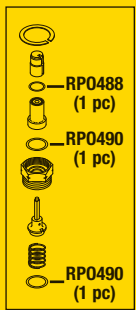

RPI Part #AMK216
OEM Part #764326-481

SEAT KIT (EXHAUST)

- Material: Stainless steel seats and EPDM O-Rings
- Includes: S40 .094" seat, CK6 .109" seat, CK8 .750" short seat, S3 .750" long seat, (2) CK4 and S37 .218" seats, and (2 pcs) O-Ring (RPI Part #RPO444)
- Fits:** Exhaust Manifold
- Models:** Century V116 & V120

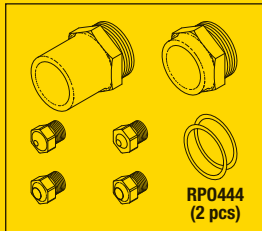

RPI Part #CSK050
OEM Part #54187; P764326-621; 62470303

SOLENOID VALVE REPAIR KIT

- Material: Nitrile (Buna-N) seals
- Includes all parts as shown
- Included in: PM Pack (Water Manifold) (RPI Part #AMP213)
- Also available: Seat Kit (Exhaust) (RPI Part #AMK216)
- Fits:** Water Manifold: S7 and S4
- Models:** Century V116 & V120

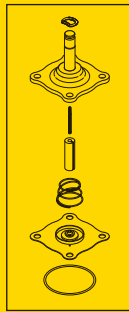

RPI Part #AMK183
OEM Part #764187-001 (S26) & 764326-482 (S3)

SOLENOID VALVE REPAIR KIT FOR 3/8" PORT VALVES

- EPDM seal
- Includes all parts as shown
- Included in: PM Pack (Exhaust Manifold) (RPI Part #AMP212)
- Also available: Seat Kit (Exhaust) (RPI Part #AMK216)
- Fits:** Solenoid Valve: Steam to Jet S26 and Exhaust Manifold S3
- Models:** Century V116, V120 & Eagle 2000

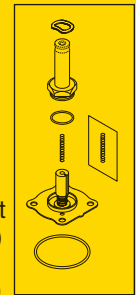

RPI Part #AMK217
OEM Part #764326-620

SEAT KIT (WATER)

- Material: Stainless steel seats and EPDM O-Rings
- Includes: CK5 .750" short seat, (2) S4 and S7 .750" long seats, and (3 pcs) O-Ring (RPI Part #RPO444)
- Fits:** Water Manifold
- Models:** Century V116 & V120

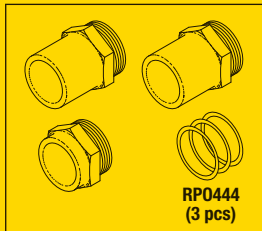

RPI Part #AMT187
OEM Part #129222-001

STEAM TRAP ASSEMBLY

- Includes all parts as shown
- 1/2" MPT port
- Includes: Steam Trap Assembly Repair Kit (RPI Part #AMK188)
- Fits:** Steam Trap and Exhaust Manifold TR1
- Models:** Century V116, V120, V148, V160, Eagle 2000, 3000 & Medallion

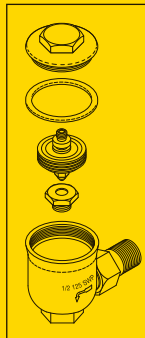

RPI Part #AMK188
OEM Part #764080-001

STEAM TRAP REPAIR KIT

- Includes all parts as shown
- Included in: PM Pack (Exhaust Manifold) (RPI Part #AMP212) and PM Pack (Misc) (RPI Part #AMP214)
- Also available: Seat Kit (Exhaust) (RPI Part #AMK216) and Steam Trap Assembly (RPI Part #AMT187)
- Fits:** Steam Trap and Exhaust Manifold TR1
- Models:** Century V116, V120, V148, V160, Eagle 2000, 3000 & Medallion

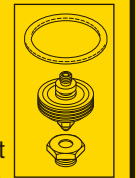



RPI Part #AMK225
OEM Part #764326-485

CHECK VALVE & FLOW CONTROL KIT

- Seal material: EPDM
 - Includes all parts as shown
 - Included In: PM Pack (Exhaust Manifold) (RPI Part #AMP212) and PM Pack (Double Door) (RPI Part #AMP209)
 - Also available: Seat Kit (Exhaust) (RPI Part #AMK216)
- Fits:** Exhaust Manifold CK4 and CK6/FC2 and Double Door Manifold CK7/FC3
Models: Century V116 & V120

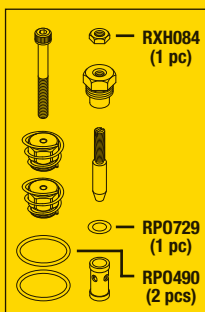

RPI Part #AMV282
OEM Part #056402-067

CHECK VALVE

- Cracking pressure: 0.50 PSI
 - Ports: 3/4" FPT x 3/4" FPT
 - Material: Stainless steel valve with Teflon (PTFE) seals
 - Size: 1.75" Hex x 3.37" lg.
- Fits:** Filtered Air Line CK1
Models: Century V136, V148 & V160

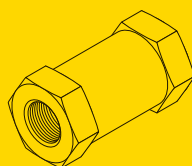

RPI Part #AMV284
OEM Part #150829-501

CHECK VALVE

- Cracking pressure: 1 PSI
 - Ports: 1/4" FPT x 1/4" FPT
 - Material: Brass body; EPDM seals
 - Also available: Check Valve Repair Kit (RPI Part #AMK285)
- Fits:** Steam Bleed Line CK4
Models: Century V136, V148 & V160

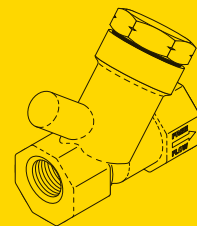

RPI Part #RXH084
OEM Part # (OEM Part # Not Available)

HEX NUT (#10-32)

- 25 per package
 - Material: Stainless steel
 - Size: 3/8" Hex x 1/8" Thick
 - Included in: Check Valve & Flow Control Kit (RPI Part #AMK225)
- Models:** Century V116 & V120



RPI Part #AMV286
OEM Part #056402-068

CHECK VALVE

- Cracking pressure: 0.50 PSI
 - Ports: 1" FPT x 1" FPT
 - Material: Stainless steel valve with Teflon (PTFE) seals
 - Size: 2" Hex x 4" lg.
- Fits:** Exhaust Line CK8
Models: Century V136, V148 & V160

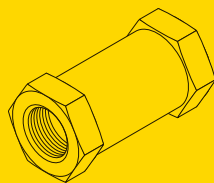

RPI Part #AMK285
OEM Part #764329-776

CHECK VALVE REPAIR KIT

- Seal material: Viton® (FKM)
 - Also available: Check Valve (RPI Part #AMV284)
- Fits:** Steam Bleed Check Valve CK4
Models: Century V136, V148 & V160

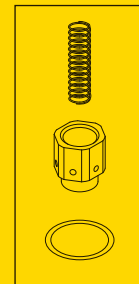

RPI Part #AMK227
OEM Part #764326-484/764326-622

CHECK VALVE REPAIR KIT

- Seal material: Viton® (FKM)
 - Includes all parts as shown
 - Included In: PM Pack (Exhaust Manifold) (RPI Part #AMP212) and PM Pack (Water Manifold) (RPI Part #AMP213)
 - Also available: Seat Kit (Water) (RPI Part #AMK217) and Seat Kit (Exhaust) (RPI Part #AMK216)
- Fits:** Exhaust Manifold CK8 and Water Manifold CK5
Models: Century V116 & V120

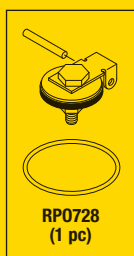

RPI Part #AMV283
OEM Part #083521-001

CHECK VALVE

- Cracking pressure: 0.50 PSI
 - Ports: 1/4" FPT x 1/4" FPT
 - Material: Brass body, EP seal
 - Size: .69" sq. x 1.69" lg.
- Fits:** Water Line CK2
Models: Century V136, V148 & V160

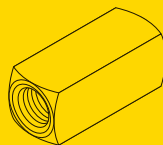

RPI Part #AM0289
OEM Part #129376-082

ORIFICE (DOOR SEAL)

- 2 per package
 - .094" Orifice
 - Ports: 1/4" MPT x 1/4" MPT
 - Material: 303 Stainless Steel
- Fits:** Door Seal Channel FC3 & FC4
Models: Century V136, V148 & V160

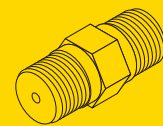

RPI Part #AMH294
OEM Part #093918-051

PRINTER HEAD

- Ribbon printer
 - Size: 3.58" x 1.85" x .62" thk.
 - Includes: Printer Cartridge (RPI Part #MIC226)
 - Also available: Printer Paper (RPI Part #RXP088)
- Fits:** Printer
Models: Century V116, V120, V136, V148 & V160

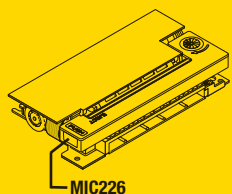

RPI Part #MIC226
OEM Part # (OEM Part # Not Available)

PRINTER CARTRIDGE

- Epson® brand ribbon cartridge; Color: Black
 - Also available: Printer Head (RPI Part #AMH294) and Printer Paper (RPI Part #RXP088)
- Fits:** Printers
Models: Century V116, V120, V136, V148 & V160

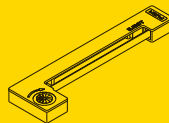

RPI Part #RXP088
OEM Part #129359-008

PRINTER PAPER

- 5 per package
 - Size: 2.25" wide
 - Also available: Printer Head (RPI Part #AMH294) and Printer Cartridge (RPI Part #MIC226)
- Fits:** Printer
Models: Century V116, V120, V136, V148 & V160

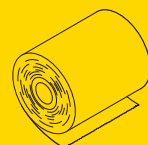

RPI Part #AMG287
OEM Part #136816-097

PRESSURE GAUGE (JACKET)

- Size: 4-1/2" Dial face
- Dual scale: 0 to 100 PSIG, 0 to 7 Bar
- Port: 1/2" MPT, bottom mount

Fits: Front Panel

Models: Century V136, V148 & V160

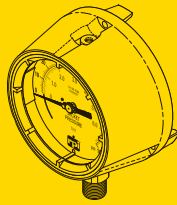

RPI Part #AMS253
OEM Part #764323-470

**PRESSURE CONTROL SWITCH
(OPERATING PRESSURE)**

- 120/240 VAC, 15A
- Factory set to: On @ 70 PSI - Off @ 80 PSI
- 275°F Max temperature

Fits: Steam Generator

Models: Century V116 & V120

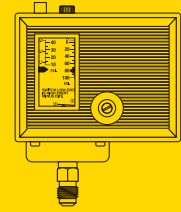

RPI Part #AMG288
OEM Part #136816-096

PRESSURE GAUGE (CHAMBER)

- Size: 4-1/2" Dial face
- Dual scale: -30 Hg. 0 to 100 PSIG.;
-1.0 to +7.0 Bar
- Port: 1/2" MPT, bottom mount

Fits: Front Panel

Models: Century V136, V148 & V160

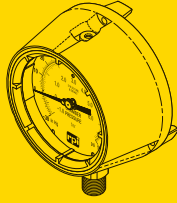

RPI Part #AMS254
OEM Part #764323-471

PRESSURE SWITCH (HIGH LIMIT)

- 120/240 VAC, 15A
- Factory set to: On @ 75 PSI - Off @ 85 PSI
- 275°F Max temperature

Fits: Steam Generator

Models: Century V116 & V120

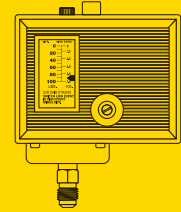

New Parts to fit AMSCO/STERIS® Century V116, V120, V136, V148 & V160 Sterilizers!

ADDRESS SERVICES REQUESTED

PERMITTED STANDARD
U.S. POSTAGE PAID
VAN NUYS, CA
PERMIT NO. 2399

625 Cochran Street • Simi Valley, California • 93065
replacement parts industries, inc.



PARTS YOU NEED MOST!

- **Check Valves & Check Valve Kits**
- **Heat Exchanger**
- **Manifold PM Packs**
- **Pressure Gauges**
- **Pressure Switches**
- **Seal Kits**
- **Solenoid Valve Repair Kits**
- **Steam Trap Assembly & Repair Kit**
- **Printer Head, Cartridge & Paper**



RPI Part #AMX290
OEM Part #136816-022

HEAT EXCHANGER

- Size: 12.20" x 4.40" x 1.69"
- Ports: 1" MPT x (4)
- Rated up to 435 PSI and 450°F steam

Fits: Mounts on top of Vacuum/Pump Assembly

Models: Century V136, V148 & V160

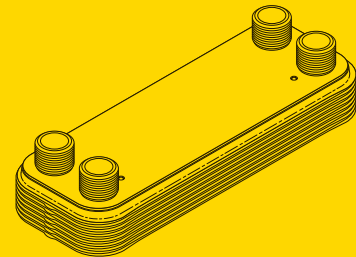

Models: Century V116, V120, V136, V148 & V160



Parts to fit AMSCO/STERIS® Century Sterilizers

New Door Motor, Capacitor, and Power Door Assembly Parts!

RPI Part #AMM279
OEM Part #136809-709



DOOR MOTOR

- 115 VAC, 60Hz; 6.5 RPM
- Includes: Mounting hardware
- Also available: Capacitor (3µF, 370 VAC) (RPI Part #AMC280)

Fits: Door Motor Housing

Models: Century V116, V120, V136, V148 & V160

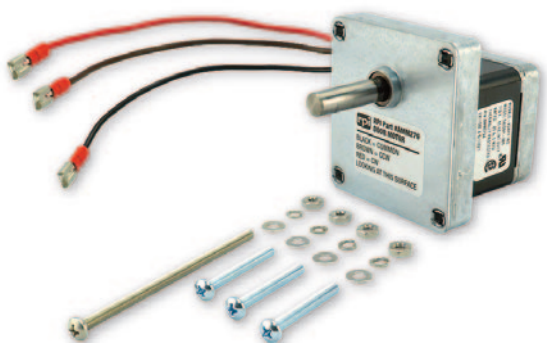

RPI Part #AMK241

OEM Part #129367-563 (Turnbuckle),
129367-562 (Nut, knurled), **150824-374** (Nut, hex)



TURNBUCKLE KIT

- Includes: Turnbuckle, knurled nut, and (1 pc) Hex Nut (#10-24) (RPI Part #RPH112)

Fits: Power Door Assembly

Models: Century V116 & V120



RPI Part #AMC236
OEM Part #93911-961



CABLE (DOOR)

- Size: 31.5" lg.;
- 1/4-28 stud x 5/16" eyelet

Fits: Power Door Assembly

Model: Century V116



RPI Part #AMC280
OEM Part #93918-050



CAPACITOR (3µF, 370 VAC)

- Size: 2.06" x 1.22" (oval case) x 2.00" lg.
- Quad 1/4" tabs

Fits: Door Motor Housing

Models: Century V116, V120, V136, V148 & V160



RPI Part #AMC235
OEM Part #93918-039



CABLE (SHEAVE)

- Size: 56.25" lg.;
- #10-24 stud x #10 eyelet

Fits: Power Door Assembly

Model: Century V116

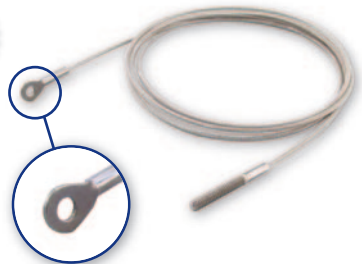

RPI Part #AMP239
OEM Part #93911-952

PULLEY (16")

Fits: Power Door Assembly

Model: Century V116



RPI Part #AMP240
OEM Part #93918-990

PULLEY (20")

Fits: Power Door Assembly

Model: Century V120

RPI Part #AMC238
OEM Part #93918-357



CABLE (DOOR DRIVE)

- Size: 64.25" lg.;
- #10-24 stud x 3/16" catch ball

Fits: Power Door Assembly

Model: Century V120

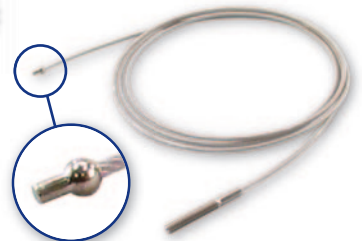

RPI Part #AMC237
OEM Part #93918-358



CABLE (COUNTER WEIGHT)

- Size: 37.75" lg.;
- 1/4-28 stud x 3/8" eyelet

Fits: Power Door Assembly

Model: Century V120

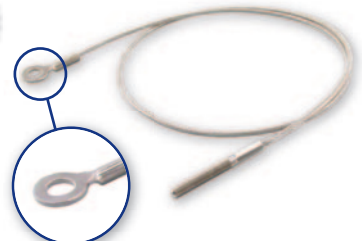

* All Cables are stranded stainless steel cable with clear PVC jacket.



replacement parts industries, inc.

CALL (800) 221-9723 • FAX (818) 882-7028 • EMAIL order@riparts.com • WEBSITE www.riparts.com

The above parts are manufactured by Replacement Parts Industries, Inc. to fit the equipment noted. All product names used in this document are trademarks or registered trademarks of their respective holders. Flyer Code 2006AM Rd2 SHOW 07/21

Models: 100 Series, 400 Series, 500 Series, 700 Series, 3522, 3523, 3525, 3533, 6300 Series, 6400 Series, 6900 Series, & MC3600

RPI Part #CSG102
OEM Part #61301607691



DOOR GASKET (17.50" x 17.50")

- Material: Blue silicone
 - Custom formulated for greater lubricity!
 - .65" OD cross section
- Fits:** Chamber
Models: 400 Series

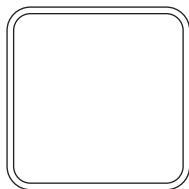

CSG102
CROSS SECTION
NOT SHOWN ACTUAL SIZE

RPI Part #CSG103
OEM Part #61301607692



DOOR GASKET (21" x 21")

- Material: Blue silicone
 - Custom formulated for greater lubricity!
 - .65" OD cross section
- Fits:** 21.50" x 21.50" Door
Models: 500 Series

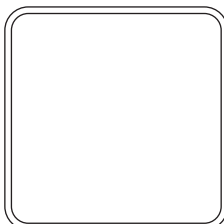

CSG103
CROSS SECTION
NOT SHOWN ACTUAL SIZE

RPI Part #CSG104
OEM Part #61301609906



DOOR GASKET (26.50" x 36")

- Material: Blue silicone
 - Custom formulated for greater lubricity!
 - .65" OD cross section
- Fits:** 26.5" x 36.00" Door
Models: 700 Series

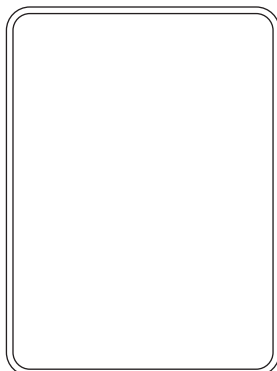

CSG104
CROSS SECTION
NOT SHOWN ACTUAL SIZE

RPI Part #CSG003
OEM Part #40441



DOOR GASKET (24" x 36")

- Material: Blue silicone
 - New material with greater lubricity!
 - .43" OD cross section
- Fits:** 24" x 36" Door
Models: 6300 Series, 6400 Series & 6900 Series

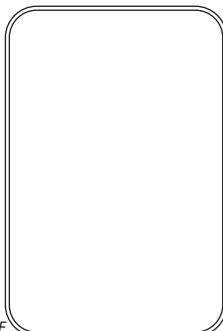

CSG003
CROSS SECTION
NOT SHOWN ACTUAL SIZE

RPI Part #CSG002
OEM Part #61301605017 & 58397



DOOR GASKET (16" x 16")

- Material: Blue silicone
 - New material with greater lubricity!
 - .43" OD cross section
- Fits:** 16" x 16" Door
Models: 3522, 3525 & 3533

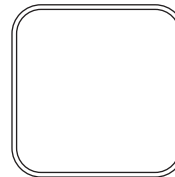

CSG002
CROSS SECTION
NOT SHOWN ACTUAL SIZE

RPI Part #CSG030
OEM Part #513966



DOOR GASKET (16" x 16")

- Material: Blue silicone
 - New material with greater lubricity!
 - .40" x .40" "U" shaped cross section
- Fits:** 16" x 16" Door
Models: 3522, 3525 & 3533

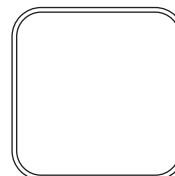

CSG030
CROSS SECTION
NOT SHOWN ACTUAL SIZE

RPI Part #CSG001
OEM Part #61301605016 & 58398



DOOR GASKET (20" x 20")

- Material: Blue silicone
 - New material with greater lubricity!
 - .43" OD cross section
- Fits:** 20" x 20" Door
Models: 100 Series & 3523

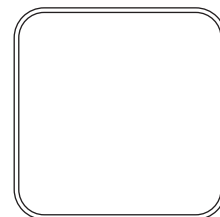

CSG001
CROSS SECTION
NOT SHOWN ACTUAL SIZE

RPI Part #CSG031
OEM Part #513967



DOOR GASKET (20" x 20")

- Material: Blue silicone
 - New material with greater lubricity!
 - .40" x .40" "U" shaped cross section
- Fits:** 20" x 20" Door
Models: 100 Series & 3523

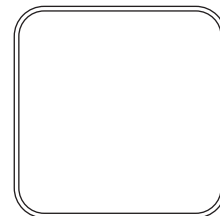

CSG031
CROSS SECTION
NOT SHOWN ACTUAL SIZE

RPI Part #CSG032
OEM Part #536651



DOOR GASKET (24" x 36")

- Material: Blue silicone
 - New material with greater lubricity!
 - 1" OD cross section
- Fits:** 24" x 36" Door
Models: MC3600

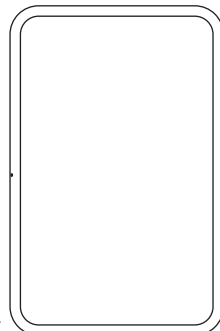

CSG032
CROSS SECTION
NOT SHOWN ACTUAL SIZE

Warning: These gaskets are not for use in Ethylene Oxide (E.O. Gas) sterilizers

Bulk Sterilizers

For PM Packages & Spare Parts Packages, see last page of Castle/Getinge.

Models: 100 Series, 400 Series, 500 Series, 700 Series, 3522, 3523, 3525, 3533, 3622, 3623, 3633, 6300 Series, 6400 Series, 6900 Series & MC3600

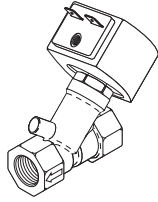

SOL-1 Steam to Chamber
SOL-4 Multitherm Bypass
SOL-7 Multitherm Steam
SOL-8 Steam to Jacket

RPI Part #CSV004
OEM Part #517339

SOLENOID VALVE ASSEMBLY

- Ports: 3/8 FPT; Piston style angle valve; 2 way N.C.
- 120VAC 60Hz. 6.1W.
- 110VAC 50Hz. 8.1W.
- Brass body; PTFE seal
- Also available: Solenoid Valve Repair Kit (RPI Part #AMK177)

Models:

- SOL-1:** 3522, 3525 & 3533
SOL-4: 3523, 3623 & 3633
SOL-7: 3622, 3623 & 3633
SOL-8: 3522, 3523 & 3533

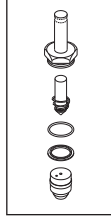

SOL-1 Steam to Chamber
SOL-4 Multitherm Bypass
SOL-7 Multitherm
SOL-8 Steam to Jacket
SOL-10 Door Seal/Unseal
SOL-12 Door Seal/Unseal
SOL-16 Vent

RPI Part #AMK177
OEM Part #61301601739

SOLENOID VALVE REPAIR KIT

- Piston style repair kit
- PTFE seal
- Also available: Solenoid Valve Assembly (RPI Part #CSV004)

Models:

- SOL-1:** 100 Series, 400 Series, 500 Series, 3522, 3525 & 3533
SOL-4: 100 Series, 3523 & 3633
SOL-7: 3522, 3523 & 3633
SOL-8: 400 Series, 500 Series, 3522, 3523 & 3533
SOL-10 & 12: 400 Series, 500 Series & 700 Series
SOL-16: 3525

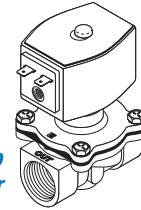

SOL-1 Steam to Chamber

RPI Part #CSV005
OEM Part #517345

SOLENOID VALVE ASSEMBLY

- Ports: 3/4 FPT; Diaphragm style valve; 2 way N.C.
- 120VAC 60Hz. 6.1W.
- 110VAC 50Hz. 10.1W.
- Brass body; EPDM seal
- Also available: Solenoid Valve Repair Kit (RPI Part #AMK183)

Model: 3523

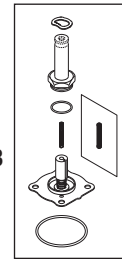

RPI Part #AMK183
OEM Part #54190

SOLENOID VALVE REPAIR KIT

- Diaphragm style repair kit
 - Also available: Solenoid Valve Assembly (RPI Part #CSV005)
- Model:** 3522, 3523, 3525 & 3533

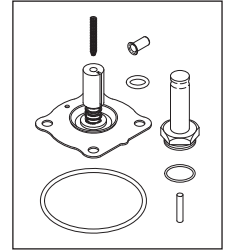

SOL-1 Steam to Chamber
SOL-2 Fast Exhaust

RPI Part #CSK024
OEM Part #61301604084

SOLENOID VALVE REPAIR KIT

- Diaphragm style repair kit
- EPDM seals

Fits: 1" FPT Valve

Models:

- SOL-1:** 3622, 3623 & 3633
SOL-2: 3622, 3623 & 3633

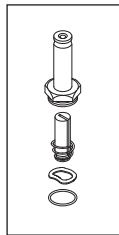

SOL-3 Air-In

RPI Part #CSK018
OEM Part #517295

SOLENOID VALVE REPAIR KIT

- Piston style repair kit
- Fits:** Solenoid Valve Assembly
Models:
SOL-3: 400 Series, 500 Series, 3523 & 3533

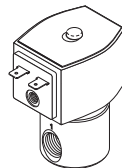

SOL-5 Slow Exhaust

RPI Part #CSV009
OEM Part #517354

SOLENOID VALVE ASSEMBLY

- Ports: 1/4 FPT; Piston style valve; 2 way N.C.
- 120VAC 60Hz. 6.1W.
- 110VAC 50Hz. 8.1W.
- Stainless steel body; EPDM seal
- Also available: Solenoid Valve Repair Kit (RPI Part #CSK020)

Model: 3523

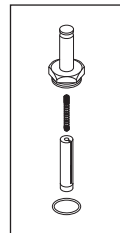

RPI Part #CSK020
OEM Part #517298

SOLENOID VALVE REPAIR KIT

- Piston style repair kit fits Solenoid Valve Assembly (RPI Part #CSV009)
- SOL-5:** 100 Series, 400 Series, 500 Series & 3523

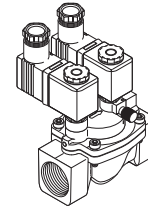

SOL-5 Slow Exhaust
SOL-6 Vac-Water

RPI Part #CSV008
OEM Part #517356

DUAL COIL SOLENOID VALVE

- This is not an ASCO® Valve Assembly
- Ports: 3/4 FPT; Diaphragm style valve; 3 way N.C.
- 110VAC 50Hz. 7.5W.
- Brass body; Manual operator
- Also available: Solenoid Valve Repair Kit (RPI Part #CSK061) and Coil (RPI Part #CSC063)

Models: 3522, 3533, 3622, 3623 & 3633

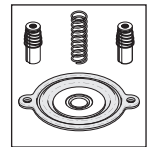

SOL-5 Slow Exhaust
SOL-6 Vac-Water

RPI Part #CSK061
OEM Part # (No OEM Part # Available)

SOLENOID VALVE REPAIR KIT

- Fits RPI Dual Coil Solenoid Valve (RPI Part #CSV008) **only**; (For kit to repair OEM Dual Coil Solenoid Valve No. 517356, see RPI Part #CSK019)

Models: 3522, 3533, 3622, 3623 & 3633

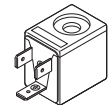

RPI Part #CSC063
OEM Part # (No OEM Part # Available)

COIL

- Fits Dual Coil Solenoid Valve (RPI Part #CSV008) **only**
 - 110 VAC 50Hz. 7.5W (650Ω)
 - 1/4" Tabs
- Models:** 3522, 3533, 3622, 3623 & 3633

Models: 100 Series, 200 Series, 400/500 Series, 700 Series, 800 Series, 3522, 3523, 3525, 3533, 3622, 3623, 3633, 4200, 6300, 6400 & 6900

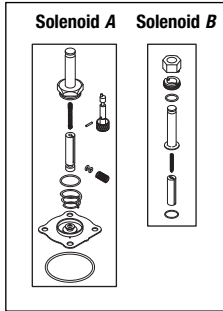

SOL-5 Slow Exhaust
SOL-6 Vac-Water

RPI Part #CSK019
OEM Part #61301601738
OLD OEM Part #518018

DUAL SOLENOID VALVE REPAIR KIT

- Repair Kit for use with Sol-5 & Sol-6 (Castle/Getinge Valve No. 517356) **only**
 - Includes:
 - SOL-A:** Diaphragm style repair kit, EPDM seal
 - SOL-B:** Piston style repair kit, PTFE seal
- Models:** 3522, 3533, 3622, 3623 & 3633

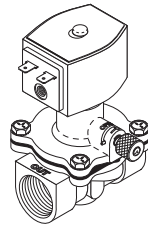

SOL-6 Vac-Water

RPI Part #CSV010
OEM Part #517349

SOLENOID VALVE ASSEMBLY

- 3/4 FPT; Diaphragm style valve; 2 way N.C.
 - Brass body; EPDM seal
 - 120 VAC 60Hz. 10.1W.
- Models:** 3522 & 3525

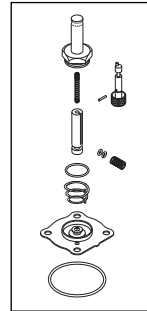

SOL-6 Vac-Water
SOL-6 Water to Ejector

RPI Part #AMK174
OEM Part #56161

SOLENOID VALVE REPAIR KIT

- Diaphragm style repair kit
 - EPDM seal
- Models:**
SOL-6 Vac-Water: 3522 & 3525
SOL-6 Water to Ejector: 3522, 3523, 3525 & 3533

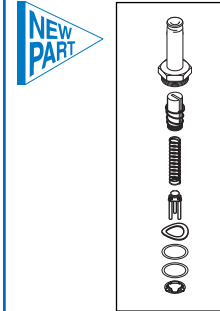

SOL-5 Cooling Water
SOL-10 & 11 Door Seal

RPI Part #CSK048
OEM Part #68164

SOLENOID VALVE REPAIR KIT

- Diaphragm style repair kit
 - EPDM seals
- Models:**
SOL-5: 3522, 3523, 3525 & 3533
SOL-10 & 11: 3522, 3525 & 3533

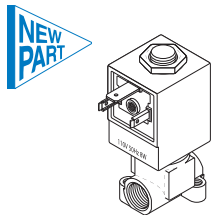

SOL-7 Multitherm Steam

RPI RPI Part #CSV011
OEM Part #517353

SOLENOID VALVE ASSEMBLY

- 1/4 FPT; Piston style valve; 2 way N.C.
 - Brass body; PTFE seal
 - 110 VAC 50Hz. 8W
 - This is **not** an ASCO® Valve Assembly
- Model:** 3523

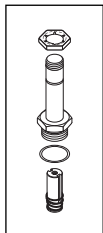

RPI Part #CSK062
OEM Part # (No OEM Part # Available)

SOLENOID VALVE REPAIR KIT

- Piston style repair kit fits Solenoid Valve Assembly (RPI Part #CSV011) **only**

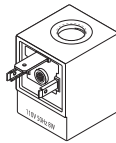

SOL-7 Multitherm Steam

RPI RPI Part #CSC064
OEM Part # (No OEM Part # Available)

COIL

- Fits Solenoid Valve Assembly (RPI Part #CSV011) **only**
 - 110 VAC 50Hz. 8W
 - ~220Ω
 - 1/4" Tabs
- Model:** 3523

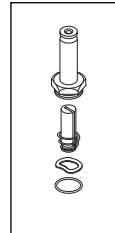

SOL-7 Multitherm Steam

RPI Part #CSK022
OEM Part #517297

SOLENOID VALVE REPAIR KIT

- Piston style repair kit
 - PTFE seal
- Model:** 3523

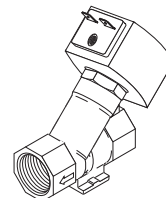

SOL-8 Steam to Jacket

RPI Part #CSV014
OEM Part #517342

SOLENOID VALVE ASSEMBLY

- 3/4 FPT; Piston style valve; 2 way N.C.
 - Brass body; Tefzel® seal
 - 120VAC 60Hz. 10.1W.
- Models:** 3622, 3623, 3633, 4200 & 6900

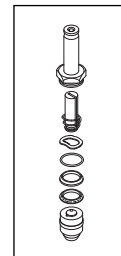

RPI Part #CSK025
OEM Part #54186

SOLENOID VALVE REPAIR KIT

- Piston style repair kit fits Solenoid Valve Assembly (RPI Part #CSV014)

Models: 100 Series, 200 Series, 400/500 Series, 700 Series, 800 Series, 3522, 3523, 3525, 3533, 3622, 3623, 3633, 4200, 6300, 6400 & 6900

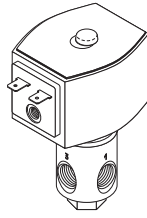

SOL-10 & 11 Door

RPI Part #CSV012
OEM Part #541582

SOLENOID VALVE ASSEMBLY

- 1/4 FPT; Piston style valve; 3 way N.C.
- SS body; EPDM seal
- 120 VAC 60Hz. 10.1W.

Models: 3522, 3523, 3525, 3533, 4200 & 6900

RPI Part #CSK023
OEM Part #61301600442

SOLENOID VALVE REPAIR KIT

- Piston style repair kit fits Solenoid Valve Assembly (RPI Part #CSV012)

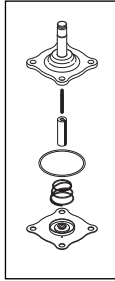
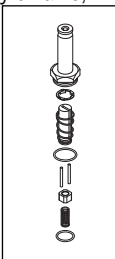

SOL-13 Spray Water

RPI Part #CSK050
OEM Part #54187

SOLENOID VALVE REPAIR KIT

- Diaphragm style repair kit
- Buna-N seal

Models: 3525, 4200MPS & 6900AMPS



RPI Part #CSK065
OEM Part #513700

CHECK VALVE REBUILD KIT

- For use with a 3/4" or 1" NPT valve
- Includes all parts as shown

Fits: 3/4" or 1" NPT In-Line Check Valve
Models: 3522, 3523, 3525, 3533, 3622 & 3633

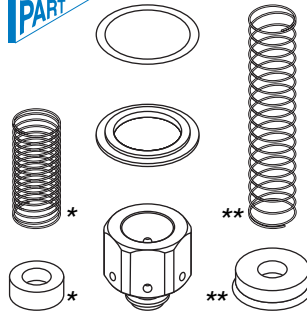

RPI Part #CSK066
OEM Part #513369

CHECK VALVE REBUILD KIT

- For use with a 1/2", 3/8" or 3/4" valve
- Viton O-ring; Stainless Steel springs and retainer; Brass disc holder
- Includes all parts as shown

Fits: Check Valve (OEM Part #'s 513361, 513362 & 513363)
Models: 100 Series, 200 Series, 400/500 Series, 700 Series, 800 Series, 3522, 3523, 3525, 3533, 3622, 3633, 4200MPS & 6900AMPS

* Fits 1/2" Check Valve (OEM Part #513361)
** Fits 3/8" Check Valve (OEM Part #513362) and 3/4" Check Valve (OEM Part #513363)

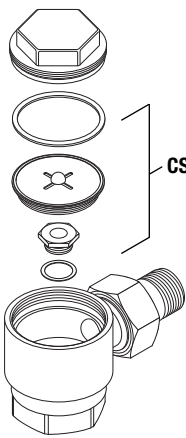

CSK067

RPI Part #CST059
OEM Part #61301602492

STEAM TRAP

- 1/2" MPT x 1/2" FPT
- Material: brass body; stainless steel seat
- Max. rated pressure: 125 PSI; Max. operating temperature: 450 °F
- Also available, Steam Trap Rebuild Kit (RPI Part #CSK067)

Fits: Jacket or Chamber to Jacket
Models: 100 Series, 200 Series, 400/500 Series, 700 Series, 800 Series, 3522, 3523, 3525, 3533, 3622 & 3633

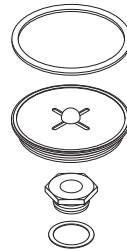

RPI Part #CSK067
OEM Part # (No OEM Part # Available)

STEAM TRAP REBUILD KIT

- Includes all parts as shown
- Also available, Steam Trap (RPI Part #CST059)

Fits: 1/2" Valve
Models: 100 Series, 200 Series, 400/500 Series, 700 Series, 800 Series, 3522, 3523, 3525, 3533, 3622 & 3633

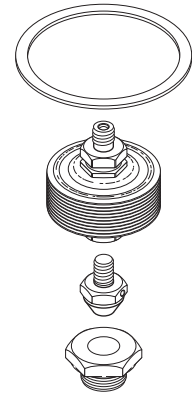

RPI Part #CSK060
OEM Part #27557

STEAM TRAP REBUILD KIT

- Includes all parts as shown
- Fits:** Only fits Steam Trap (OEM Part #23614) 3/4" Valve
- Models:** 200 Series, 3622, 3633, 4200MPS & 6900AMPS

For PM Packages & Spare Parts Packages, see last page of Castle/Getinge. Bulk Sterilizers

Models: 100 Series, 200 Series, 400/500 Series, 700 Series, 800 Series, 3522, 3523, 3525, 3533, 3622, 3623, 3633, 4200, 6300, 6400 & 6900

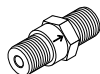

RPI Part #CSV056
OEM Part #14010
CHECK VALVE
 • 1/4" MPT
 • Material: brass body; EPDM seal
 • 4 PSI opening pressure
Fits: Steam Line
Models: 3522, 3523, 3525 & 3533

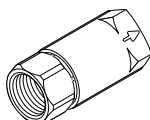

RPI Part #CSV057
OEM Part #19114
CHECK VALVE
 • 1/2" FPT
 • Material: bronze body; RPTFE® seal
 • 0.5 PSI opening pressure
Fits: Steam Line
Models: 3522, 3523, 3525 & 3533

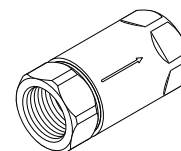

RPI Part #CSV058
OEM Part #08045
CHECK VALVE
 • 3/4" FPT
 • Material: bronze body; RPTFE® seal
 • 0.5 PSI opening pressure
Fits: Water Supply Line
Models: 3522, 3523, 3525 & 3533

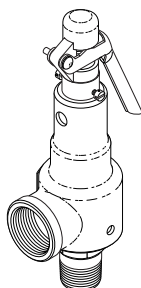

RPI Part #CSV033
OEM Part #56913
SAFETY RELIEF VALVE
 • 3/4" MPT x 1" FPT
 • Material: Bronze
 • Cracking pressure: 40 PSI
Fits: Air Supply Line
Models: 3622 & 3633

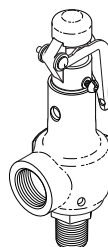

RPI Part #CSV034
OEM Part #61301604180
SAFETY RELIEF VALVE
 • 1/2" MPT x 3/4" FPT
 • Material: Bronze body
 • Cracking pressure: 40 PSI
Fits: Chamber Plumbing
Models: 3522, 3523, 3525 & 3533

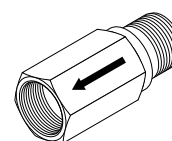

RPI Part #CSV035
OEM Part #532554
RELIEF VALVE
 • 1" MPT x 1" FPT
 • Material: Brass body, stainless steel springs, EPDM seal
 • Cracking pressure: 5 PSI
Fits: Dedicated Vent System
Models: 3622 & 3633

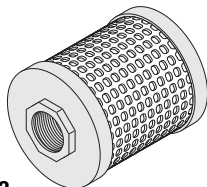

RPI Part #CSF052
OEM Part #61301600303
FILTER, AIR-IN
 • 2.84" OD x 3.10" Long
 • 3/4" FPT
 • 0.03 micron HEPA media
Fits: Air Supply line
Models: 100 Series, 200 Series, 400/500 Series, 3522, 3523, 3525, 3533, 4200MPS & 6900AMPS



RPI Part #CSS053
OEM Part #43907
SCREEN FILTER
 • .78" OD x 2.13" Long
 • Material: stainless steel
 • 20 x 20 Mesh
Fits: Strainer Assembly
Models: 3522, 3523, 3525, 3533, 3622 & 3633



RPI Part #CSS054
OEM Part #45690
SCREEN, DETERGENT
 • .60" OD x .39" Tall
 • Material: stainless steel
 • 80 x 80 Mesh
Fits: Tubing to Detergent Pump
Models: 3522, 3523, 3525, 3533, 3622 & 3633

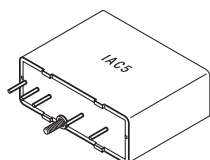

RPI Part #CSR028
OEM Part #86407
SOLID STATE RELAY
 • 1.70" L x .58" W x 1.25" H
 • 90 - 140VAC input; 50ma 30VDC output
 • Solder or PCB terminals
 • IAC5
Fits: Control Panel
Models: 3522, 3523, 3525, 3533, 3622, 3623 & 3633

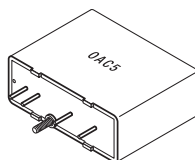

RPI Part #CSR029
OEM Part #86408
SOLID STATE RELAY
 • 1.70" L x .58" W x 1.25" H
 • 3.8 - 8VDC input; 3A 120VAC output
 • Solder or PCB terminals
 • OAC5
Models: 3522, 3523, 3525, 3533, 3622, 3623 & 3633

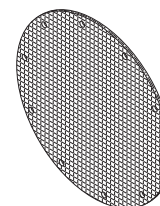















RPI Part #CSD051
OEM Part #517153
DIAPHRAGM REPLACEMENT 1.0
 • 9.0" Diameter
 • Material: Nylon reinforced EP
Fits: Drain Valve
Models: 3522, 3523, 3525 & 3533

Bulk Sterilizers

Models: 100 Series, 200 Series, 400/500 Series, 700 Series, 800 Series, 3522, 3523, 3525, 3533, 3622, 3623, 3633, 4200, 6300, 6400 & 6900

PM PACKAGES & SPARE PARTS PACKAGES

RPI PART #	OEM PART #	DESCRIPTION	(QTY) & RPI PART #'S INCLUDED IN KIT
 CSP036	61301602085	PM PKG (SOLENOID VALVES) Models: 3522, 3523 & 3533	• Solenoid Valve Repair Kits: (1) AMK174, (2) AMK177, (1) AMK183 & (2) CSK048
 CSP037	61301602090	PM PKG (SOLENOID VALVES) Models: 3525	• Diaphragm Replacement: (1) CSD051 • Solenoid Valve Repair Kits: (1) AMK174, (2) AMK177, (1) AMK183, (2) CSK048 & (1) CSK050
 CSP038	61301602091	PM PKG (FILTER & SCREEN) Models: 3522, 3523, 3525 & 3533	• Filter: (1) CSF052 • Screen Filter: (2) CSS053
 CSP039	61301602087	PM PKG (STM TRAP & CHK VLV) Models: 3525	• Check Valve Rebuild Kit: (3) CSK066 • Steam Trap: (2) CST059
 CSP040	61301602092	PM PKG (STM TRAP & CHK VLV) Models: 3525	• Check Valves: (1) CSV056, (1) CSV057 & (1) CSV058 • Check Valve Rebuild Kit: (1) CSK066
 CSP068	61301602079	PM PKG (STM TRAP & CHK VLV) Models: 3622 & 3633	• Check Valve Rebuild Kits: (1) CSK065 & (3) CSK066 • Steam Trap: (1) CST059 • Steam Trap Rebuild Kit: (1) CSK060
 CSP069	No OEM Part # Available	PM PKG (STM TRAP & CHK VLV) Models: 3522, 3523, 3525 & 3533	• Check Valve Rebuild Kit: (3) CSK066 • Steam Trap Rebuild Kit: (1) CSK067
 CSP070	No OEM Part # Available	PM PKG (STM TRAP & CHK VLV) Models: 3622 & 3633	• Check Valve Rebuild Kits: (1) CSK065 & (3) CSK066 • Steam Trap Rebuild Kit: (1) CSK060 & (1) CSK067
 CSP041	61301602510	SPARE PARTS PACKAGE Models: 3525	• Check Valves: (1) CSV056, (1) CSV057 & (1) CSV058 • Check Valve Rebuild Kit: (3) CSK066 • Diaphragm Replacement: (1) CSD051 • Door Gasket: (1) CSG002 • Filter: (1) CSF052 • Solenoid Valve Repair Kits: (1) AMK174, (2) AMK177, (1) AMK183, (3) CSK048 & (1) CSK050 • Screen, Detergent: (1) CSS054 • Solid State Relay: (1) CSR028 & (1) CSR029
 CSP042	61301602498	SPARE PARTS PACKAGE Models: 3522	• Check Valve Rebuild Kit: (3) CSK066 • Door Gasket: (1) CSG002 • Solenoid Valve Repair Kits: (1) AMK174, (2) AMK177 (1) AMK183 & (2) CSK048 • Solid State Relay: (1) CSR028 & (1) CSR029 • Steam Trap: (2) CST059
 CSP043	61301602499	SPARE PARTS PACKAGE Models: 3523	• Check Valve Rebuild Kit: (3) CSK066 • Door Gasket: (1) CSG002 • Filter: (1) CSF052 • Solenoid Valve Repair Kits: (1) AMK174, (2) AMK177, (1) AMK183 & (3) CSK048 • Solid State Relay: (1) CSR028 & (1) CSR029 • Steam Trap: (3) CST059
 CSP044	61301602500	SPARE PARTS PACKAGE Models: 3533	• Check Valve Rebuild Kit: (3) CSK066 • Door Gasket: (1) CSG002 • Filter: (1) CSF052 • Solenoid Valve Repair Kits: (1) AMK174, (2) AMK177, (1) AMK183, (1) CSK018 & (2) CSK048 • Solid State Relay: (1) CSR028 & (1) CSR029 • Steam Trap: (2) CST059
 CSP045	61301602501	SPARE PARTS PACKAGE Models: 3522	• Check Valve Rebuild Kit: (3) CSK066 • Door Gasket: (1) CSG001 • Solenoid Valve Repair Kits: (1) AMK174, (2) AMK177, (1) AMK183 & (2) CSK048 • Solid State Relay: (1) CSR028 & (1) CSR029 • Steam Trap: (2) CST059
 CSP046	61301602502	SPARE PARTS PACKAGE Models: 3523	• Check Valve Rebuild Kit: (3) CSK066 • Door Gasket: (1) CSG001 • Filter: (1) CSF052 • Solenoid Valve Repair Kits: (1) AMK174, (2) AMK177, (1) AMK183 & (3) CSK048 • Solid State Relay: (1) CSR028 & (1) CSR029 • Steam Trap: (3) CST059
 CSP047	61301602503	SPARE PARTS PACKAGE Models: 3533	• Check Valve Rebuild Kit: (3) CSK066 • Door Gasket: (1) CSG001 • Filter: (1) CSF052 • Solenoid Valve Repair Kits: (1) AMK174, (2) AMK177, (1) AMK183, (1) CSK018 & (2) CSK048 • Solid State Relay: (1) CSR028 & (1) CSR029 • Steam Trap: (2) CST059



RPI Part #CST079
OEM Part #61301603751

STEAM TRAP

- 3/4" FPT
- Material: Brass body; valve and seat: 416 stainless steel
- Max operating pressure: 200 PSI
- Max allowable temperature: 400°F
- Includes all parts as shown
- Also available: Steam Trap Rebuild Kit (RPI Part #CSK080)

Fits: Steam Line
Models: 200 Series

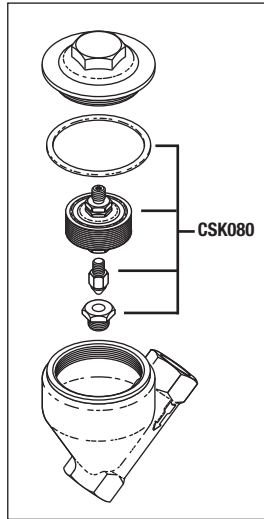

RPI Part #CSK080
OEM Part #61301603755

STEAM TRAP REBUILD KIT

- Includes all parts as shown
- Also available: Steam Trap (RPI Part #CST079)

Fits: Steam Trap
Models: 200 Series

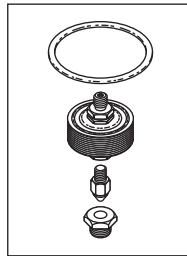

RPI Part #CST081
OEM Part #23614

STEAM TRAP

- 3/4" FPT
- Material: Brass body; valve and seat: 416 stainless steel
- Max operating pressure: 200 PSI
- Max allowable temperature: 400°F
- Includes all parts as shown
- Also available: Steam Trap Rebuild Kit (RPI Part #CSK060)

Fits: Steam Line

Models: 200 Series, 3600 Series, 4200 MPS Series & 6900 Series

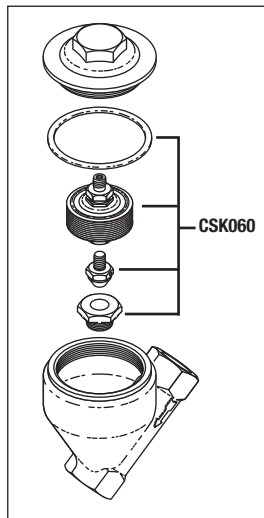

RPI Part #CSK060
OEM Part #27557

STEAM TRAP REBUILD KIT

- Includes all parts as shown
- Also available: Steam Trap (RPI Part #CST081)

Fits: Steam Trap

Models: 200 Series, 3600 Series, 4200 MPS Series & 6900 Series

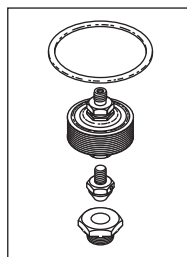

RPI Part #CST082
OEM Part #68722

STEAM TRAP

- 3/8" FPT
- Material: Stainless steel body and Disc
- Max operating pressure: 600 PSI; Min. operating pressure: 3.5 PSI
- Max allowable temperature: 800°F
- Includes all parts as shown
- Also available: Replacement Disc (RPI Part #CSD083)

Fits: Steam Line

Models: 400/500 Series, 700 Series & 4200 MPS Series

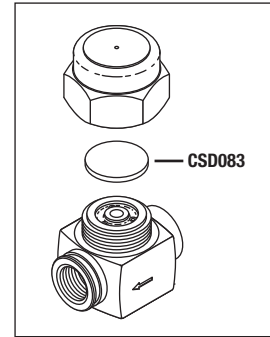

RPI Part #CSD083

OEM Part # (No OEM Part # Available)

REPLACEMENT DISC

- Material: Stainless steel
- Also available: Steam Trap (RPI Part #CST082)

Fits: Steam Trap

Models: 400/500 Series, 700 Series & 4200 MPS Series



RPI Part #CSV084

OEM Part #61301608100

SAFETY VALVE (45 PSI)

- 1/2" MPT x 1/2" FPT
- Material: Bronze body; EPDM seal
- Cracking pressure: 45 PSI

Fits: Chamber Jacket

Models: 400/500 Series & 700 Series

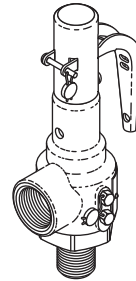

RPI Part #CSV085

OEM Part #61301601576

SAFETY VALVE (45 PSI)

- 3/4" MPT x 3/4" FPT
- Material: Bronze body; EPDM seal
- Cracking pressure: 45 PSI

Fits: Chamber Jacket

Models: 200 Series, 800-42" & 800-76"

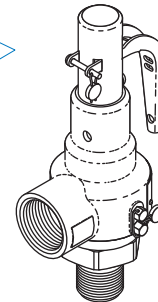

RPI Part #CSV086

OEM Part #56916

SAFETY VALVE (40 PSI)

- 1" MPT x 1-1/4" FPT
- Material: Bronze body; EPDM seal
- Cracking pressure: 40 PSI

Fits: Chamber Jacket

Models: 4200 MPS Series

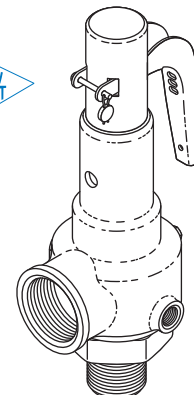

Bulk Sterilizers

Models: 100 Series, 200 Series, 400/500 Series, 700 Series, 800 Series, 3522, 3523, 3525, 3533, 3622, 3623, 3633, 4200, 6300, 6400 & 6900

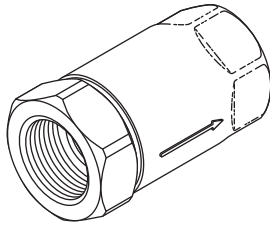

RPI Part #CSV074
OEM Part #14882

CHECK VALVE (1-1/4")

- 1-1/4" FPT
- Material: Bronze body; PTFE seal
- Cracking pressure: 0.5 PSI

Fits: In Line (Conbraco)
Models: 6900 Series

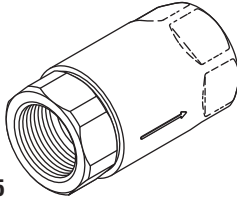

RPI Part #CSV075
OEM Part #21815

CHECK VALVE (1")

- 1" FPT
- Material: Bronze body; PTFE seal
- Cracking pressure: 0.5 PSI

Fits: In Line (Conbraco)
Models: 6900 Series

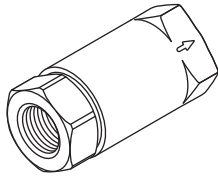

RPI Part #CSV076
OEM Part #19112

CHECK VALVE (3/8")

- 3/8" FPT
- Material: Bronze body; PTFE seal
- Cracking pressure: 0.5 PSI

Fits: In Line (Conbraco)
Models: 6900 Series

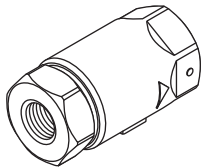

RPI Part #CSV078
OEM Part #66838

CHECK VALVE (1/4")

- 1/4" FPT
- Material: Stainless steel body; PTFE seal
- Cracking pressure: 0.5 PSI

Fits: In Line (Conbraco)
Models: 6900 Series

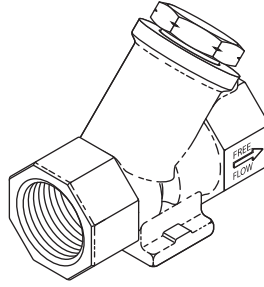

RPI Part #CSV071
OEM Part #513363

CHECK VALVE (3/4")

- 3/4" FPT
- Material: Brass body; EPDM seal
- Cracking pressure: 0.5 PSI
- Also available: Check Valve Rebuild Kit (RPI Part #CSK066)

Fits: Air Lines and Steam Lines
Models: 100 Series, 200 Series, 400/500 Series, 700 Series, 800-42", 800-76" & 4200 MPS Series

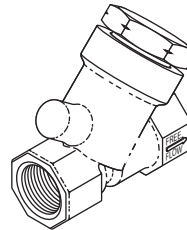

RPI Part #CSV073
OEM Part #513361

CHECK VALVE (3/8")

- 3/8" FPT
- Material: Brass body; EPDM seal
- Cracking pressure: 0.5 PSI
- Also available: Check Valve Rebuild Kit (RPI Part #CSK066)

Fits: Door Seal Line, Drain and Vent Sump Lines
Models: 100 Series, 200 Series, 400/500 Series, 700 Series, 800-42" & 800-76"

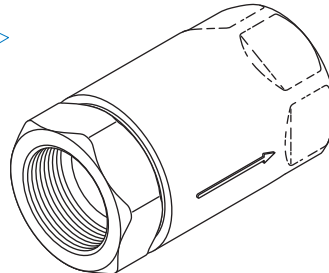

RPI Part #CSV077
OEM Part #61301602477

CHECK VALVE (1-1/2")

- 1-1/2" FPT
- Material: Bronze body; EPDM seal
- Cracking pressure: 0.2 PSI

Fits: In-Line Check (Conbraco)
Models: 4200 MPS Series

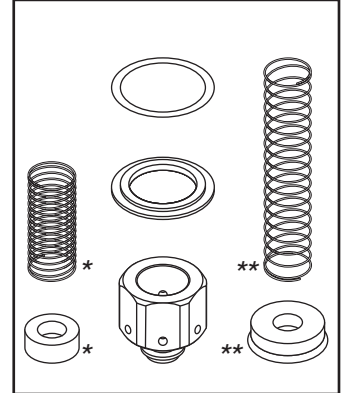

* Fits 1/2" Check Valve (OEM Part #513361)
** Fits 3/8" Check Valve (OEM Part #513362) and 3/4" Check Valve (OEM Part #513363)

RPI Part #CSK066
OEM Part #513369

CHECK VALVE REBUILD KIT

- For use with a 1/2", 3/8" or 3/4" valve
- Viton O-ring; Stainless Steel springs and retainer; Brass disc holder
- Includes all parts as shown

Fits: Check Valve (OEM Part #'s 513361, 513362 & 513363)

Models: 100 Series, 200 Series, 400/500 Series, 700 Series, 800 Series, 3522, 3523, 3525, 3533, 3622, 3633, 4200MPS & 6900AMPS

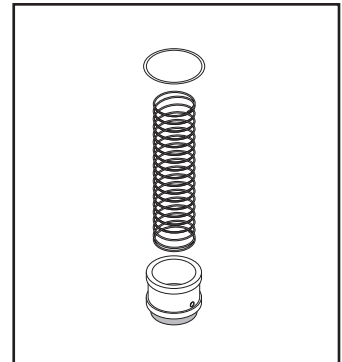

RPI Part #CSK065
OEM Part #513700

CHECK VALVE REBUILD KIT

- For use with a 3/4" or 1" NPT valve
- Includes all parts as shown

Fits: 3/4" or 1" NPT In-Line Check Valve
Models: 3522, 3523, 3525, 3533, 3622 & 3633

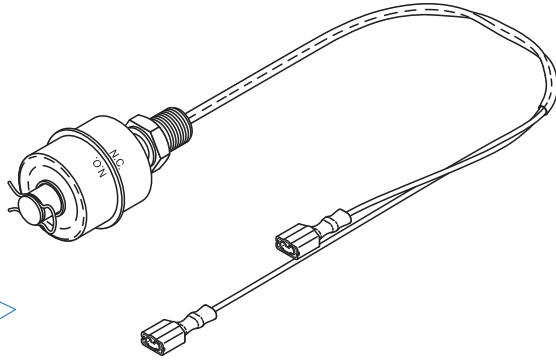

RPI Part #CSS105
OEM Part #61301601173

LIQUID LEVEL SENSOR

- Material: 316 Stainless steel float and brass stem
- 1/8" MPT
- Wire leads 9-1/2" and 11"
- 3/16" insulated QC terminals
- SPST; 120-240 VAC

Fits: Drain Plumbing

Models: 100/200/400/500/700 Series

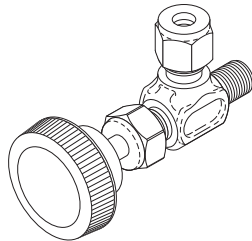

RPI Part #CSV106
OEM Part #11929

MINI VALVE

- Material: Brass body, PTFE seals
- Size: 1/8" MPT inlet x 1/8" compression tube outlet

Fits: Drain Plumbing

Models: 100/400/500/700/3500 series

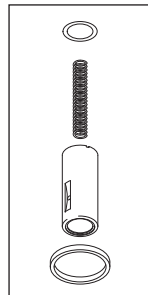

RPI Part #CSK094
OEM Part #61301608963

SOLENOID VALVE REPAIR KIT

- Teflon® seal
- For **Black** Coil Valves
- Includes all parts as shown

Fits/Models:

– 400/500/700 Series & 800-42": Sol-5 Cooling Water Valve and Sol-14 Secondary Drain Valve



RPI Part #CSK092
OEM Part # (No OEM Part # Available)

SOLENOID VALVE REPAIR KIT

- Fits valve's upper section and manual override body
- Viton® seals
- For **Black** Coil Valves
- Includes all parts as shown
- Now you can repair the valve with this one-of-kind RPI valve repair kit. It's the RPI Advantage!
- Also available: Solenoid Valve Repair Kit (RPI Part #CSK096) - Fits bottom section

Fits/Models:

– 400/500/700 Series & 800-42": Sol-6 Water to Ejector Valve Assembly (OEM Part #61301609315)

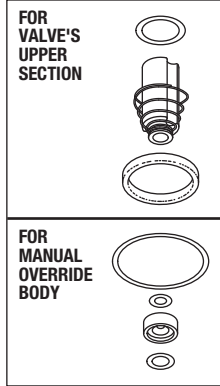

RPI Part #CSK096
OEM Part #61301609505

SOLENOID VALVE REPAIR KIT

- Fits valve's lower section
- Viton® seals
- For **Black** Coil Valves
- Includes all parts as shown
- Also available: Solenoid Valve Repair Kit (RPI Part #CSK092) - Fits top section

Fits/Models:

– 400/500/700 Series & 800-42": Sol-6 Water to Ejector Valve Assembly (OEM Part #61301609315)

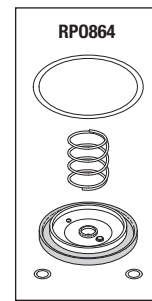

RPI Part #CSK107
OEM Part #61301608965

SOLENOID VALVE REPAIR KIT

- Brass body with Teflon® seat
- For **Black** Coil Valves
- Includes all parts as shown

Fits/Models:

– 700 Series; 800-42" & 800-76": Sol-2 Chamber Drain (Pneumatic) Valve Assembly

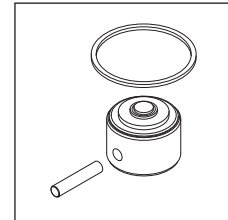

RPI Part #CSK108
OEM Part #61301609451

SOLENOID VALVE REPAIR KIT

- Viton® seal
- For **Black** Coil Valves
- Includes all parts as shown

Fits/Models:

– 400/500 Series: Sol-3 Air-In (Black Coil) Valve Assembly

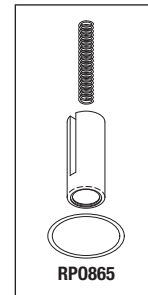

The **WATER-MIZER** is a water saving and tempering device for steam sterilization equipment that efficiently mixes cold water with steam condensate discharged from the sterilizer. This reduces the discharged water temperature before it enters the municipal sewer system. Instead of requiring a continuous flow of cold water, the **WATER-MIZER** monitors the drain temperature and applies cold water to temper the discharge only when needed.

The **WATER-MIZER** is non-electrical, no wiring is required and it operates independently from the sterilizer's controls. The average water savings with a **WATER-MIZER** installed is 45-50 gallons per hour per sterilizer.

The **WATER-MIZER** works with the majority of bulk sterilizers in use today, and is small enough to fit neatly underneath them. Minimal piping and fittings are all that is required for installation.

RPI Part #RPA466

WATER-MIZER®

- The Water-Mizer, a water-saving device, eliminates the "tempering" water consumption during the non-sterilizing portion of a sterilizer's cycle, thereby substantially reducing overall water consumption.
- Two year limited warranty
- For installation, it is recommended to use Pipe Sealant 567 (RPI Part #RPA459) or 1/2" Teflon Sealing Tape (RPI Part #RPT580)
- Easy installation with existing bulk sterilizers including: AMSCO 2000 & 3000 Series, Pre-1995 Getinge/Castle, and other older model bulk sterilizers.

Models: Call RPI Technical Support for assistance in identifying models that the Water-Mizer fits

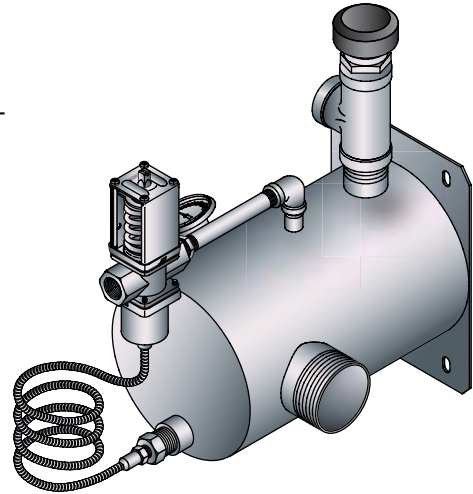

For more information about the Water-Mizer, visit the RPI website www.rpiparts.com

RPI Part #RPV468

VALVE (COMPLETE)

- Temperature range: 100°-175°F (37°-79°C)
 - 3/8" FPT
 - 18" capillary
 - RPI Sterico valve
- Model:** Water-Mizer

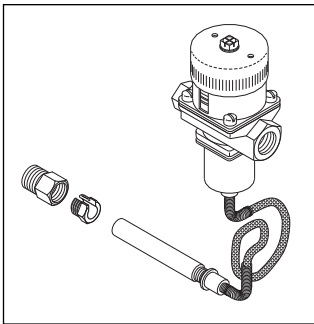

RPI Part #RPS475

SENSOR

- Temperature range: 100°-175°F 37°-79°C
- Fits:** Only Sterico Valve (RPI Part #RPV468)
- Model:** Water-Mizer

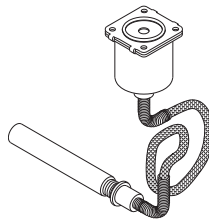

RPI Part #RPK478

WATER INLET VALVE REPAIR KIT

- Fits:** Only Sterico Valve (RPI Part #RPV468)
- Model:** Water-Mizer

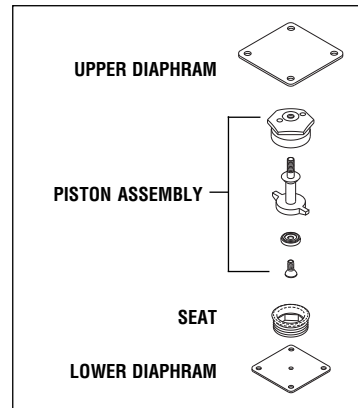

RPI Part #RPT469

DIAL THERMOMETER

- 1.75" dia. dial face x 6" lg. stem; 1/4" MPT
- Stainless steel; glass cover
- Temperature range: 0°-220°F (-10°-100°C)

Fits: Auxiliary port (adapter not included)

Models: Water-Mizer

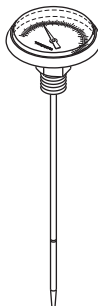

RPI Part #RPH470

ADJUSTABLE FLOOR STAND

- Stainless steel
- Includes (4 each): 1/4-20 x 3/4" Lg. bolt, 1/4" Flat Washer & 1/4" Nylok Nut

Model: Water-Mizer

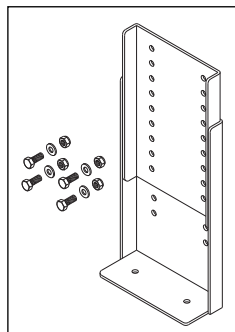

RPI Part #RPK692

WATER INLET VALVE REPAIR KIT

- Fits:** Only Johnson Control Valve
- Model:** Water-Mizer

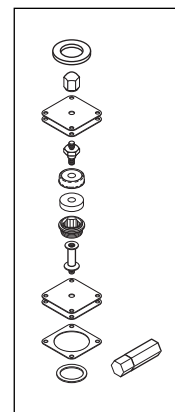

SERVICE TIP
THE WATER INLET VALVE REPAIR KIT (RPI PART #RPK692) FITS ONLY THE JOHNSON CONTROL VALVE, SHOWN HERE.

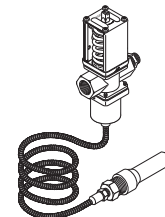

RPI Part #RPV479

VACUUM BREAKER

- 1/2" MPT
 - 15 psi max. pressure
 - Maximum temperature: 250 °F (121°C)
- Model:** Water-Mizer



Automated Endoscope Reprocessors

Models: Advantage Plus®, CER Optima®, DSD-91E®, DSD-201®, DSD Edge®, & SSD-102®

STERILIZERS - MINNTECH (MEDIVATORS)

**FITS
DSD-201!**

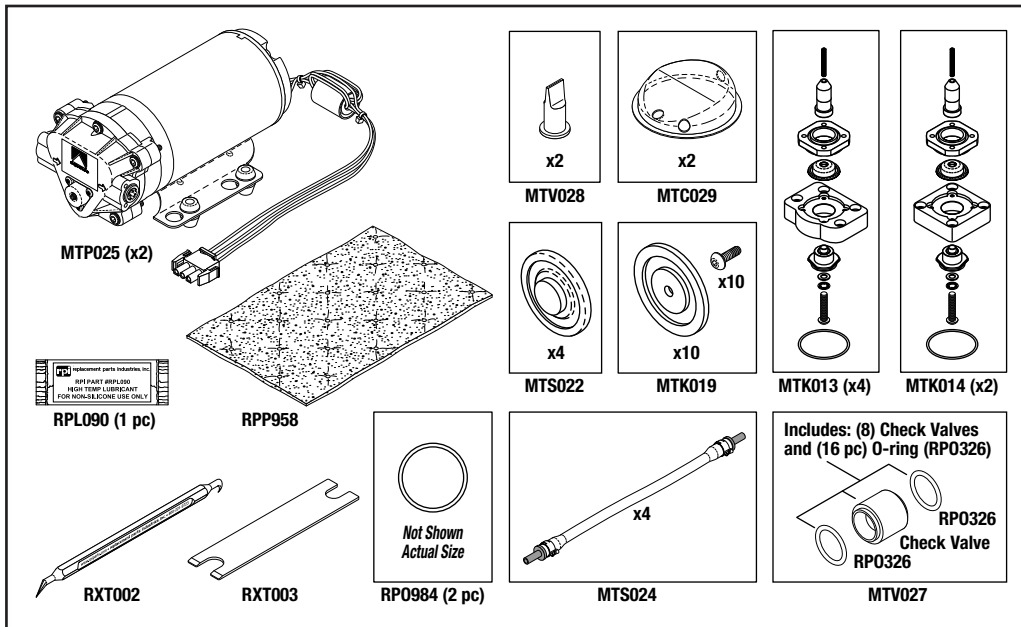

**NEW
PART**

RPI Part #MTK009
OEM Part #78400-722

PM KIT

- Annual PM Kit
- For use on DSD-201 machines that have been upgraded to the 3/4" drain valve (OEM Part #78401-050 which is also included in the PM Kit #78400-724) or have a DSD-201 with serial #649904-064 and above.
- Includes all parts as shown
- All Parts also sold separately - See Pages 452-454.

Model: DSD-201

**FITS
DSD EDGE!**

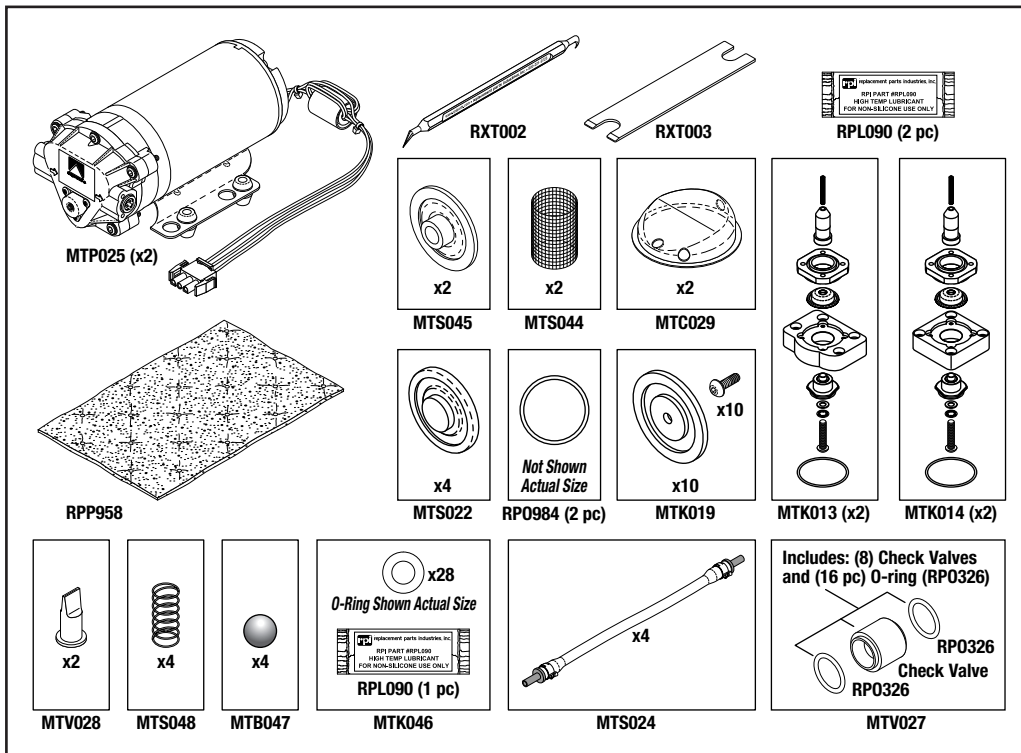

**NEW
PART**

RPI Part #MTK033
OEM Part #78401-176

PM KIT

- Annual PM Kit
- Includes all parts as shown
- All Parts also sold separately - See Pages 452-454.

Model: DSD Edge

Call Us Toll-Free Monday-Friday, 8:00 AM-4:30 PM (Pacific Time), (800) 221-9723

SECTION

10

PAGE

450

UPDATED

10/18

Automated Endoscope Reprocessors

Models: Advantage Plus®, CER Optima®, DSD-91E®, DSD-201®, DSD Edge®, & SSD-102® (continued)

RPI Part #MTA001
OEM Part #MF01-0028



AIR FILTER ASSEMBLY

- 8 per package
- 0.2 micron; 50mm filter media disc
- Color coded 1/4" flow male quick couplings (Blue-Inlet; White-Outlet)
- Includes: Tubing (3/8" ID x .594" OD Clear Braided) (RPI Part #RPT879)

Fits: Air Compressor Line

Models: Advantage Plus, CER Optima, DSD-91E, DSD-201, DSD Edge, & SSD-102

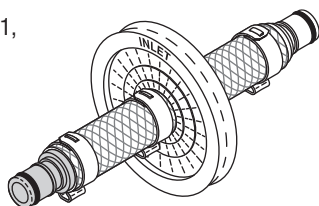

RPI Part #MTF004
OEM Part #MF01-0015



PREFILTER CARTRIDGE (0.45 MICRON ABSOLUTE)

- Size: 2.55" OD x 10" lg.
- Silicone O-Rings

Fits: Incoming Water Line

Models: DSD-91E, DSD-201, DSD Edge, & SSD-102

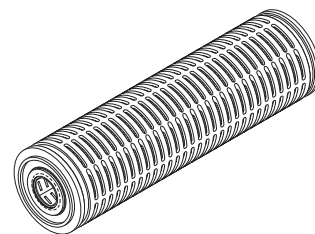

RPI Part #MTA002
OEM Part #MF01-0011



DISINFECTANT FILTER ASSEMBLY

- 12 per package
- 65 micron
- Color coded 1/4" flow male quick couplings (Red-Inlet; Grey-Outlet)
- Includes: Tubing (3/8" ID x .594" OD Clear Braided) (RPI Part #RPT879)

Fits: Disinfectant Line

Models: CER Optima, DSD-91E, DSD-201, & SSD-102

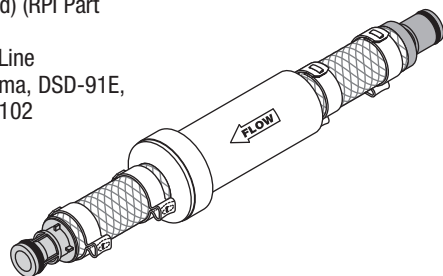

RPI Part #MTF005
OEM Part #MF01-0014



PREFILTER (1 MICRON)

- Size: 2-1/2" OD x 10" lg.

Fits: Pre Filter Assembly

Models: CER Optima, DSD-91E, DSD-201, DSD Edge, & SSD-102

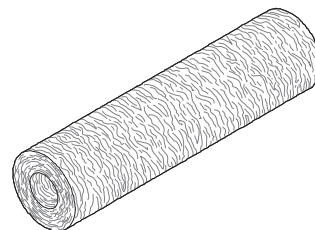

RPI Part #MTV030
OEM Part #41600-109



SOLENOID VALVE (MAC)

- 120VAC / 60 Hz., 5.4W (2.67k Ω), 110VAC / 50Hz., 5.4W (2.24k Ω)
- Material: Viton® seals
- 18" lg.; #22 AWG wire
- Includes: Gasket and mounting screws
- Also available: Coil (Solenoid Valve - MAC) (RPI Part #MTC032)

Fits: Air Delivery System

Models: DSD-201 & DSD Edge

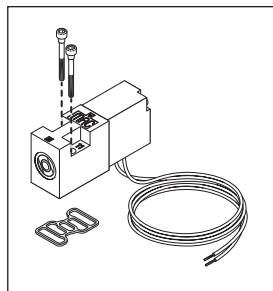

RPI Part #MTC032
OEM Part # (No OEM Part # Available)



COIL (SOLENOID VALVE - MAC)

- 120VAC / 60 Hz., 5.4W (2.67k Ω), 110VAC / 50Hz. (5.4W, 2.24k Ω)
- 18" lg.; #22 AWG wires
- Includes: Plunger assembly and mounting screws
- Also available: Solenoid Valve (MAC) (RPI Part #MTV030)

Fits: Air Delivery System

Models: DSD-201 & DSD Edge

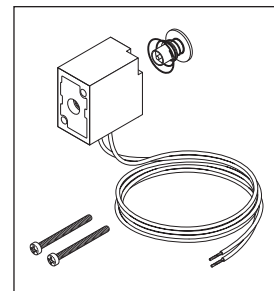

Automated Endoscope Reprocessors

Models: Advantage Plus®, CER Optima®, DSD-91E®, DSD-201®, DSD Edge®, & SSD-102® (continued)

NOTE: For use on DSD-201 machines that have been upgraded to the 3/4" drain valve (OEM #78401-050 which is also included in the PM Kit #78400-724) or have a DSD-201 with serial #649904-064 and above.

RPI Part #MTK012
OEM Part #78400-660



BASIN VALVE REBUILD KIT

- See **Note** above.
- Includes: (4) Valve Rebuild Kit (Drain/Return) (RPI Part #MTK013) and (2) Valve Rebuild Kit (Overflow) (RPI Part #MTK014)

Fits: 3/4" Drain Valve Manifold

Models: DSD-201

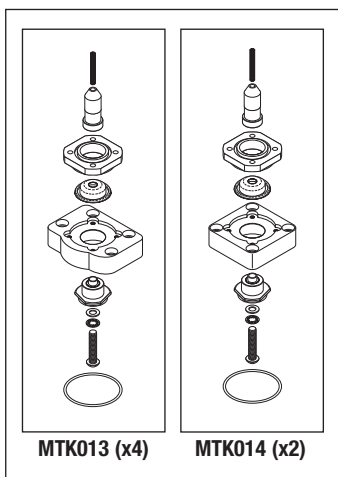

MTK013 (x4)

MTK014 (x2)

RPI Part #MTK013
OEM Part #78400-658



VALVE REBUILD KIT (DRAIN/RETURN)

- Valve #10 and #11
- See **Note** above. Also used on all DSD-Edge units.

• Includes all parts as shown

Fits: 3/4" Drain Valve Manifold

Models: DSD-201 & DSD Edge

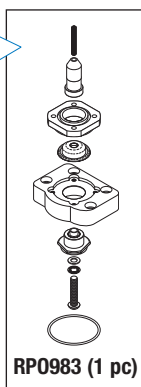

RP0983 (1 pc)

RPI Part #MTK014
OEM Part #78400-659



VALVE REBUILD KIT (OVERFLOW)

- Valve #9
- See **Note** above. Also used on all DSD-Edge units.

• Includes all parts as shown

Fits: 3/4" Drain Valve Manifold

Models: DSD-201 & DSD Edge

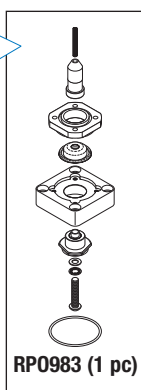

RP0983 (1 pc)

RPI Part #MTP025
OEM Part #78400-689



PUMP (DISINFECTANT)

- 115 VAC, 60 Hz.
- Includes: 10" lg. wires with ferrite and connector

Fits: Chassis

Models: DSD-201

& DSD Edge

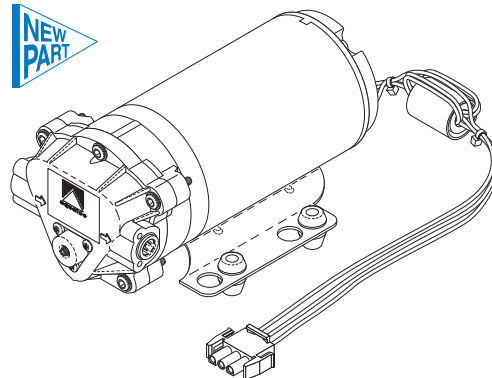

RPI Part #MTV027
OEM Part #78401-260



CHECK VALVE

- Includes all parts as shown
- Cracking Pressure: 1.60 PSI
- Material: Polycarbonate
- Size: 5/8" OD x 5/8" lg.

Fits: Fluid Manifold

Models: DSD-201 & DSD Edge

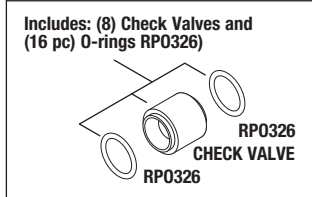

Includes: (8) Check Valves and (16 pc) O-rings RPO326

RPO326 CHECK VALVE RPO326

RPI Part #MTV028
OEM Part #MV01-0040



CHECK VALVE (ALCOHOL AND DETERGENT)

- 2 per package
- Cracking Pressure: .057 PSI
- Material: Orange Silicone
- Size: .43" dia. x .82" lg.
- Temperature Range: -60°C to +175°C

Fits: Alcohol and Detergent Assembly

Models: Advantage Plus,

DSD-201 & DSD Edge



RPI Part #MTS022
OEM Part #MV01-0035



VALVE SEAL (ALCOHOL AND DETERGENT)

- 4 per package.
- Material: Viton®

Fits: Alcohol/Detergent Valve

Models: DSD-201 &

DSD Edge



RPI Part #MTS024
OEM Part #MT010-0500



PERISTALTIC PUMP TUBING SET

- 4 per package
- Size: 10.0" lg.

Fits: Peristaltic Pump

Models: DSD-201 & DSD Edge

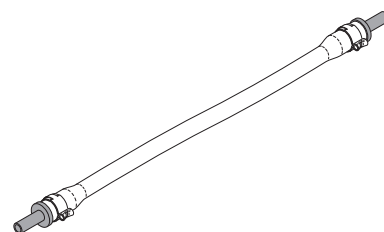

RPI Part #MTK019
OEM Part #78401-261
& 78398-538



AIR VALVE DIAPHRAGM KIT

- 10 per package
- Material: Diaphragm is custom formulated elastomer, screw is pre-coated 316 stainless steel.

Fits: Air Valve Assemblies

Models: DSD-201 &

DSD Edge

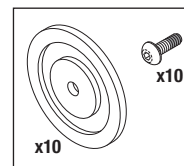

x10

x10

RPI Part #MTS045
OEM Part #41013-001



SEAL (SAMPLE PORT)

- 2 per package
- Material: Viton®
- Size: 1.17" dia. x .28" H

Fits: Sample Port Valve

Models: DSD Edge



Automated Endoscope Reprocessors

Models: Advantage Plus®, CER Optima®, DSD-91E®, DSD-201®, DSD Edge®, & SSD-102® (continued)

RPI Part #MTC029
OEM Part #MC13-0015



COVER (BASIN SENSOR)

- 2 per package
- Material: Clear PETG
- Size: ~1.60" dia.

Fits: Basin Sensor
Models: DSD-201 & DSD Edge

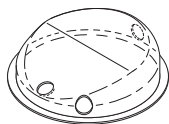

RPI Part #MTS044
OEM Part #43100-254



STRAINER

- 2 per package
- Size: 1.00" dia. x 1.35" lg. wire mesh
- Material: 80 mesh 316 stainless steel

Fits: Disinfectant Manifold
Models: DSD Edge

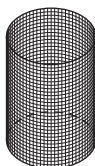

RPI Part #MTS048
OEM Part #47049-415



SPRING

- 4 per package
- Size: .240" OD x .513" lg.
- Material: Stainless steel
- Also available: Float Ball (RPI Part #MTB047)

Fits: SSG Dosing Assembly
Models: Advantage Plus & DSD Edge



RPI Part #MTB047
OEM Part #47049-658 & 47049-416



FLOAT BALL

- 4 per package
- Size: .250" dia.
- Material: Viton®
- Also available: Spring (RPI Part #MTS048)

Fits: SSG Dosing Assembly
Models: Advantage Plus & DSD Edge



RPI Part #MTK046
OEM Part #43100-302



O-RING KIT

- Includes: (28) O-rings and (1 pc) High Temp Lubricant (RPI Part #RPL090)
- Material: Viton®, 75 Duro
- Size: .176" ID x .316" OD x .070" C/S

Fits: SSG Reservoir
Models: Advantage Plus & DSD Edge

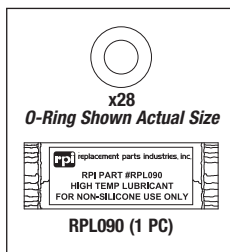

RPI Part #RP0983
OEM Part #43100-224
Industry Part #AS568-133



O-RING

- 3 per package
- Material: Viton® (FKM), 75 Duro, Black
- Size: 1.799" ID x 2.005" OD x .103" C/S

Fits: Drain Manifold Valves
Models: DSD-201 & DSD Edge

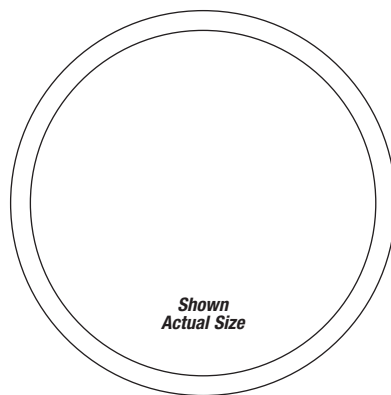

RPI Part #RP0984
OEM Part #MO01-0004



O-RING

- 6 per package
- Material: Viton®, 75 Duro
- Size: 1.176" ID x 1.316" OD x 0.70" C/S

Fits: Drain Manifold
Models: DSD-201 & DSD Edge

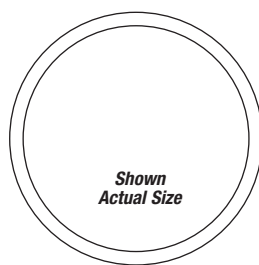

RPI Part #RPP958
OEM Part # (No OEM Part # Available)



ABSORBENT PAD

- 3 per package
- Size: 9-1/4" x 14-1/2"
- Can be used for oil drip collection and spills

Models: DSD-201 & DSD Edge

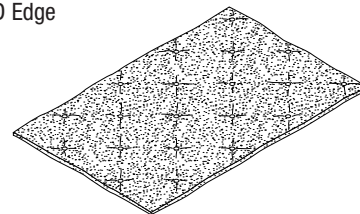

RPI Part #RXT002
OEM Part #47049-687



O-RING REMOVAL TOOL

- Made from Nylon® to avoid scratching delicate O-ring sealing surfaces
- Size: 5.5"

Models: DSD-201 & DSD Edge

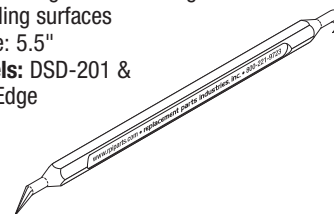

RPI Part #RXT003
OEM Part #MW03-0002



WRENCH (LOW PROFILE)

- Material: Stainless steel
- Double Ended Flat Wrench: 7/16" x 10mm
- Used to secure the valve stem flats on Medivators pneumatic valve

Models: DSD-201 & DSD Edge

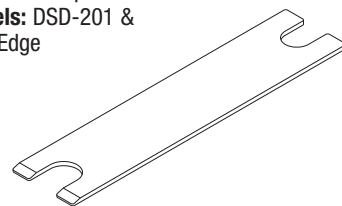

RPI Part #RXT004
OEM Part #47049-157



COLLET RELEASE WRENCH SET

- John Guest collet wrench set
- Sizes: 3/16", 1/4", 5/16", 3/8" and 1/2"

Fits: Tubing Fittings
Models: DSD-201 & DSD Edge

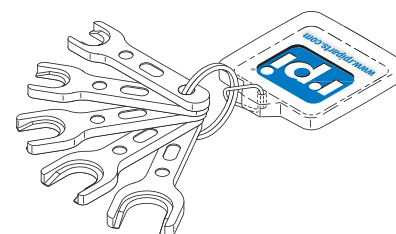

Automated Endoscope Reprocessors

Models: Advantage Plus®, CER Optima®, DSD-91E®, DSD-201®, DSD Edge®, & SSD-102® (continued)

RPI Part #RXF012
OEM Part # (No OEM Part # Available)



MALE CONNECTOR
(3/8" PUSH-IN x 1/4" MPT)

- 2 per package
- Material: Nickel plated brass
- Includes PTFE sealing ring

Fits: Air Tank Assembly
Models: DSD-201 & DSD Edge

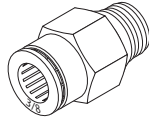

RPI Part #RXC021
OEM Part # (No OEM Part # Available)



KWIK™ CLAMP
(.59" - .67" DIA)

- 6 per package
- Material: Nylon®, Color: Black
- Clamping range: .59" - .67" dia.
- Temperature range: -40°F to 302°F

Fits: 5/8" OD Tubing
Models: DSD-201 & DSD Edge

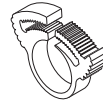

RPI Part #RXC022
OEM Part # (No OEM Part # Available)



KWIK™ CLAMP
(1.26" - 1.37" DIA)

- 6 per package
- Material: Nylon®, Color: Black
- Clamping range: 1.26" - 1.37" dia.
- Temperature range: -40°F to 302°F

Fits: 1-1/4" OD Tubing
Models: DSD-201 & DSD Edge

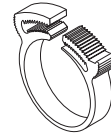

RPI Part #RXF013
OEM Part # (No OEM Part # Available)



ELBOW FITTING
(3/8" PUSH-IN x 1/8" MPT)

- 2 per package
- Material: Nickel plated brass

Fits: 4 Station Air/Valve Manifold
Models: DSD-201 & DSD Edge

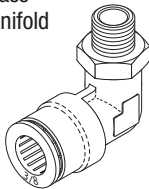

RPI Part #RPT987
OEM Part #MT01-0000 (4" lg.)



TUBING
(1" ID x 1-1/4" OD CLEAR)

- Sold by the foot (reel not included)
- Material: Clear PVC

Fits: 1" Barb Fitting
Models: DSD-201

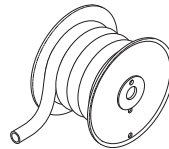

RPI Part #RXT009
OEM Part #MT01-0026



TUBING (.170" ID x 1/4" OD NATURAL TRANSLUCENT)

- Sold by the foot (reel not included)

Fits: 1/4" Push-In Fittings

Models: DSD-201 & DSD Edge

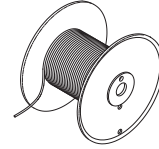

RPI Part #RXF014
OEM Part # (No OEM Part # Available)



ELBOW FITTING
(3/8" PUSH-IN x 1/4" MPT)

- 2 per package
- Material: Nickel plated brass
- Includes PTFE sealing ring

Fits: MAC Solenoid Valve Manifold Assemblies
Models: DSD-201 & DSD Edge

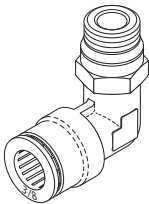

RPI Part #RPT879
OEM Part # (No OEM Part # Available)



TUBING (3/8" ID x .594" OD CLEAR BRAIDED)

- Sold by the foot (reel not included)
- Material: Clear PVC tubing with reinforced braid
- Temperature range: +25°F to +150°F
- Pressure range: @ 77°F 225 PSI
- Included in: Air Filter Assembly (RPI Part #MTA001) and Disinfectant Filter Assembly (RPI Part #MTA002)

Fits: 3/8" Barb
Models: DSD-201 & DSD Edge

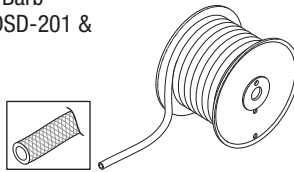

RPI Part #RXT010
OEM Part #MT01-0025



TUBING (.106" ID x 5/32" OD BLACK)

- Sold by the foot (reel not included)

Fits: 5/32" Push-In Fittings

Models: DSD-201 & DSD Edge

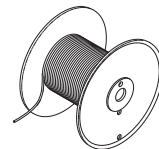

RPI Part #RXF015
OEM Part # (No OEM Part # Available)



MALE CONNECTOR
(5/32" PUSH-IN x 1/8" MPT)

- 8 per package
- Material: Nickel plated brass
- Includes PTFE sealing ring

Fits: MAC Valve Assemblies
Models: DSD-201 & DSD Edge



RPI Part #RPT959
OEM Part #MT01-0024



TUBING
(1/4" ID x 3/8" OD CLEAR)

- Sold by the foot (reel not included)
- Material: Clear polyethylene

Fits: 3/8" Push-In Fitting, 3/8" Polyflo Fitting or 1/4" Barb Fitting
Models: DSD-201 & DSD Edge

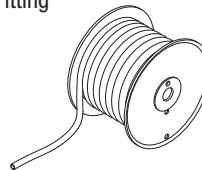

RPI Part #RXT011
OEM Part #47509-390



TUBING (.106" ID x 5/32" OD ORANGE)

- Sold by the foot (reel not included)

Fits: 5/32" Push-In Fittings

Models: DSD-201 & DSD Edge

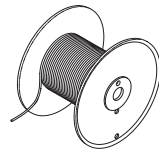

New Line of Parts to fit

Medivators®

DSD-201® & DSD Edge® AER Systems!



RPI Part #MTA053
OEM Part # (No OEM Part # Available)
MANIFOLD ASSEMBLY
(AIR VALVE, 8 STN)
 • Includes all parts as shown
 • See **Also available** below
Fits: Chassis
Models: DSD-201 & DSD Edge

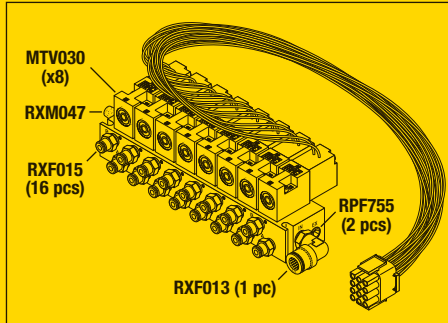

RPI Part #MTM054
OEM Part # (No OEM Part # Available)
MANIFOLD (AIR VALVE, 8 STN)
 • Includes all parts as shown
 • Included in: Manifold Assembly (Air Valve, 8 STN) (RPI Part #MTA053)
 • See **Also available** below
Fits: Chassis
Models: DSD-201 & DSD Edge

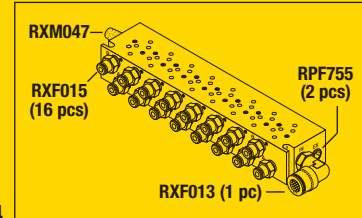

RPI Part #MTA034
OEM Part #MM01-0035
MANIFOLD ASSEMBLY
(AIR VALVE, 6 STN)
 • Includes all parts as shown
 • See **Also available** below
Fits: Chassis
Models: DSD-201 & DSD Edge

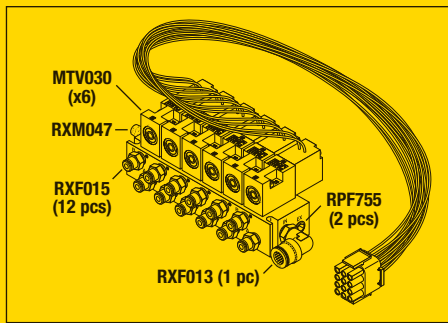

RPI Part #MTM035
OEM Part # (No OEM Part # Available)
MANIFOLD (AIR VALVE, 6 STN)
 • Includes all parts as shown
 • Included in: Manifold Assembly (Air Valve, 6 STN) (RPI Part #MTA034)
 • See **Also available** below
Fits: Chassis
Models: DSD-201 & DSD Edge

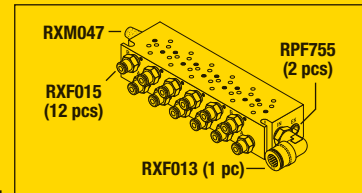

RPI Part #MTA036
OEM Part #MM01-0028
MANIFOLD ASSEMBLY
(AIR VALVE, 4 STN)
 • Includes all parts as shown
 • See **Also available** below
Fits: Chassis
Models: DSD-201 & DSD Edge

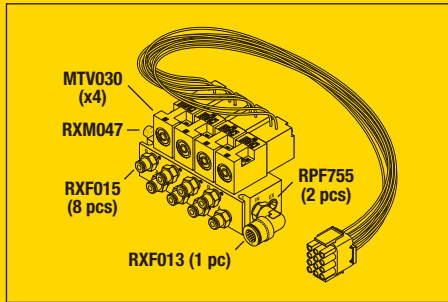

RPI Part #MTM037
OEM Part # (No OEM Part # Available)
MANIFOLD (AIR VALVE, 4 STN)
 • Includes all parts as shown
 • Included in: Manifold Assembly (Air Valve, 4 STN) (RPI Part #MTA036)
 • See **Also available** below
Fits: Chassis
Models: DSD-201 & DSD Edge

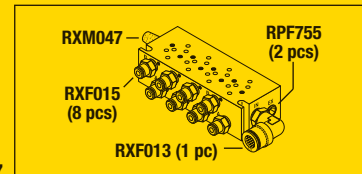

RPI Part #RXM047
OEM Part # (No OEM Part # Available)
PURGE MUFFLER (SINTERED)
 • Material: Sintered bronze and nickel plated steel
 • Port: 1/8" MP
 • Size: 7/16" Hex x 1-1/8" lg.
 • 40 micron element
Fits: Air Valve Manifold
Models: DSD-201 & DSD Edge

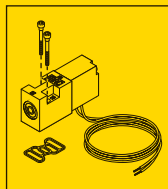
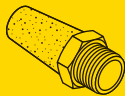

RPI Part #MTV030
OEM Part #41600-109
SOLENOID VALVE (MAC)
 • Includes all parts as shown
Fits: Air Delivery System
Models: DSD-201 & DSD Edge

Also available: Tubing (.106" ID x 5/32" OD Black) (RPI Part #RXT010) and Tubing (.106" ID x 5/32" OD Orange) (RPI Part #RXT011)

STERILIZERS - MINNTECH (MEDIVATORS)

SECTION 10
 PAGE 456
 UPDATED 05/20



replacement parts industries, inc.

CALL (800) 221-9723 • FAX (818) 882-7028 • EMAIL order@riparts.com • WEBSITE www.riparts.com

The above parts are manufactured by Replacement Parts Industries, Inc. to fit the equipment noted. All product names used in this document are trademarks or registered trademarks of their respective holders. Flyer Code 1606MT Rd2 Show 05/20

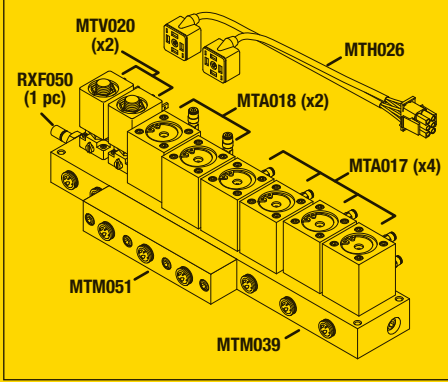

RPI Part #MTA038
OEM Part # (No OEM Part # Available)
MANIFOLD ASSEMBLY (8 STN)
 • Includes all parts as shown
 • See **Also available** below
Fits: Chassis
Models: DSD-201 & DSD Edge

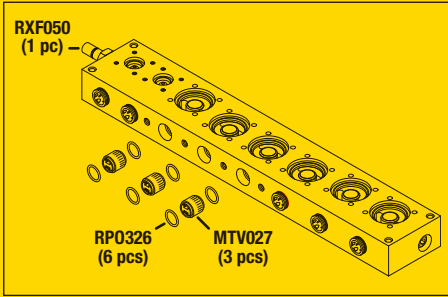

RPI Part #MTM039
OEM Part #MM01-0021
MANIFOLD (8 STN)
 • Includes all parts as shown
 • See **Also available** below
Fits: Chassis, Manifold Assembly
Models: DSD-201 & DSD Edge

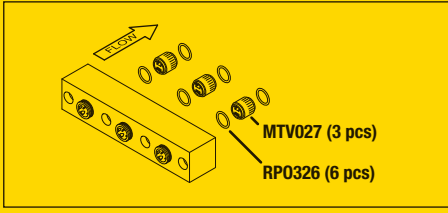

RPI Part #MTM051
OEM Part #75227-516
SUB MANIFOLD (CHECK VALVES)
 • Includes all parts as shown
 • See **Also available** below
Fits: Chassis, Manifold Assembly
Models: DSD-201 & DSD Edge



Also available: Collet Release Wrench Set (RPI Part #RXT004), Wrench (Low Profile) (RPI Part #RXT003), Tubing (.106" ID x 5/32" OD Black) (RPI Part #RXT010), Tubing (.106" ID x 5/32" OD Orange) (RPI Part #RXT011), and Locking Clips (RPI Part #RXC057)

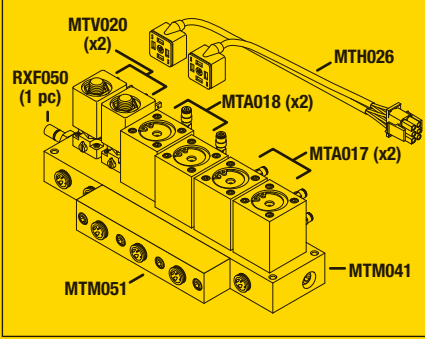

RPI Part #MTA040
OEM Part #MM01-0030
MANIFOLD ASSEMBLY (6 STN)
 • Includes all parts as shown
 • See **Also available** below
Fits: Chassis
Models: DSD-201 & DSD Edge

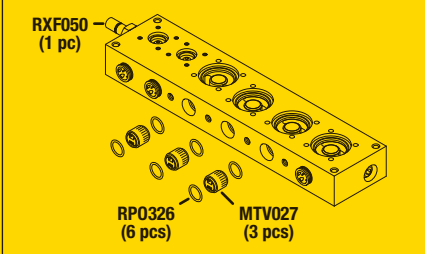

RPI Part #MTM041
OEM Part #MB02-0551
MANIFOLD (6 STN)
 • Includes all parts as shown
 • See **Also available** below
Fits: Chassis, Manifold Assembly
Models: DSD-201 & DSD Edge

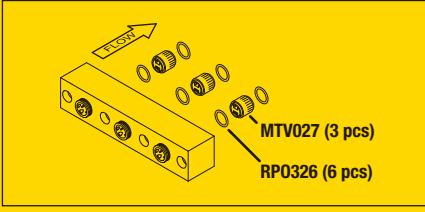

RPI Part #MTM051
OEM Part #75227-516
SUB MANIFOLD (CHECK VALVES)
 • Includes all parts as shown
 • See **Also available** below
Fits: Chassis, Manifold Assembly
Models: DSD-201 & DSD Edge



RPI Part #MTV027
OEM Part #78401-260

CHECK VALVE
 • Includes all parts as shown
Fits: Fluid Manifold
Models: DSD-201 & DSD Edge

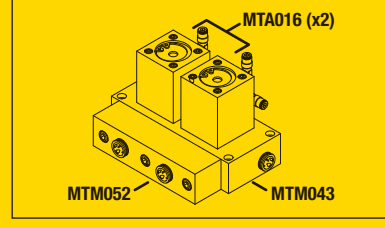
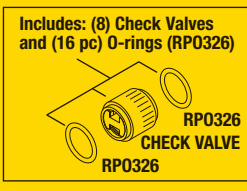

RPI Part #MTA042
OEM Part #ASM1-0086
MANIFOLD ASSEMBLY (2 STN)
 • Includes all parts as shown
 • See **Also available** below
Fits: Chassis
Models: DSD-201 & DSD Edge

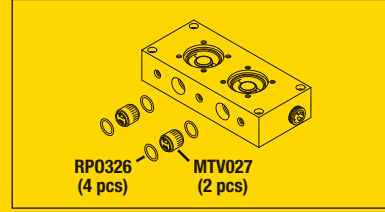

RPI Part #MTM043
OEM Part #MB02-0552
MANIFOLD (2 STN)
 • Includes all parts as shown
 • See **Also available** below
Fits: Chassis
Models: DSD-201 & DSD Edge

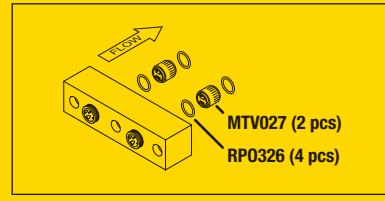

RPI Part #MTM052
OEM Part #MB02-0549
SUB MANIFOLD (CHECK VALVES)
 • Includes all parts as shown
 • See **Also available** below
Fits: Chassis, Manifold Assembly
Models: DSD-201 & DSD Edge



RPI Part #MTH026
OEM Part #43580-100
WIRING HARNESS
 • Length: 18" lg.
 • Also available: Solenoid Valve (Alcohol/Detergent) (RPI Part #MTV020)
 • Included in: Manifold Assembly (8 STN) (RPI Part #MTA038) and Manifold Assembly (6 STN) (RPI Part #MTA040)
Fits: Alcohol/Detergent Valves
Models: DSD-201 & DSD Edge



IMPORTANT NOTE: The OEM Part #41600-124 refers to two different valve block configurations. Valve Block Assembly (RPI Part #MTA016) includes (2) elbow fittings. Valve Block Assembly (RPI Part #MTA018) includes (1) elbow fitting and (1) straight fitting. Verify the configuration needed for your application.

ALSO AVAILABLE: Valve Block Rebuild Kit (RPI Part #MTK055), Tubing (.106" ID x 5/32" OD Black) (RPI Part #RXT010), Tubing (.106" ID x 5/32" OD Orange) (RPI Part #RXT011), and Wrench (Low Profile) (RPI Part #RXT003)

RPI Part #MTA016
OEM Part #41600-124



VALVE BLOCK ASSEMBLY

- Material: Hard anodized aluminum body
- Includes all parts as shown
- Included in: Manifold Assembly (2 STN) (RPI Part #MTA042)
- See **Important Notes** above

Fits: Manifold Assembly
Models: DSD-201 & DSD Edge

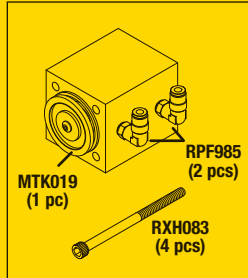

RPI Part #MTA017
OEM Part #41600-123



VALVE BLOCK ASSEMBLY

- Material: Hard anodized aluminum body
- Includes all parts as shown
- Included in: Manifold Assembly (RPI Part #'s MTA038 & MTA040)
- See **Important Note** above

Fits: Manifold Assembly
Models: DSD-201 & DSD Edge

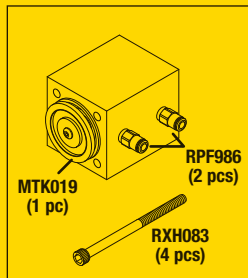

RPI Part #MTA018
OEM Part #41600-124



VALVE BLOCK ASSEMBLY

- Material: Hard anodized aluminum body
- Includes all parts as shown
- Included in: Manifold Assembly (RPI Part #'s MTA038 & MTA040)
- See **Important Note** above

Fits: Manifold Assembly
Models: DSD-201 & DSD Edge

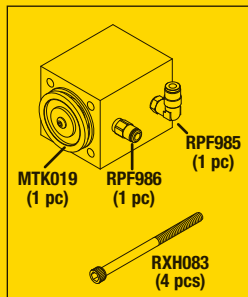

RPI Part #MTK055
OEM Part # (No OEM Part # Available)



VALVE BLOCK REBUILD KIT

- Includes all parts as shown
- Retaining ring pliers are necessary to remove and reinstall the internal retaining ring when rebuilding the Valve Block Assemblies (RPI Part #'s MTA016, MTA017 & MTA018).

Fits: Valve Block Assembly
Models: DSD-201 & DSD Edge

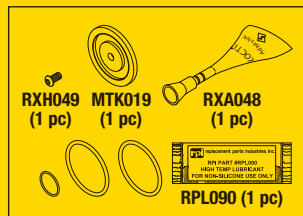

RPI Part #RXH083
OEM Part #MS05-0055



SCREW (#8-32 X 2-3/8" SOC HD)

- 8 per package; Material: Stainless steel
- The OEM valve block assembly's mounting screws are too short to use in RPI's manifolds, these longer screws must be used
- Included In: Valve Block Assembly (RPI Part #'s MTA016, MTA017 & MTA018)

Fits: Valve Block Assembly
Models: DSD-201 & DSD Edge

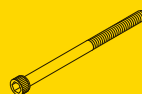

RPI Part #MTV020
OEM Part #MV01-034



VALVE ASSEMBLY
(ALCOHOL/DETERGENT)

- Manifold mount; Manual operator
- 120VAC / 50-60 Hz., 8 Watt (240 W)
- Viton® seals
- Includes: Coil (RPI Part #MTC023), Solenoid Valve Repair Kit (RPI Part #MTK021), (1pc) Valve Seal (RPI Part #MTS022) and mounting hardware
- Also available: Wiring Harness (Solenoid Valve) (RPI Part #MTH026)
- Included in: Manifold Assembly (8 STN) (RPI Part #MTA038) and Manifold Assembly (6 STN) (RPI Part #MTA040)

Fits: Manifold Assembly
Models: DSD-201 & DSD Edge

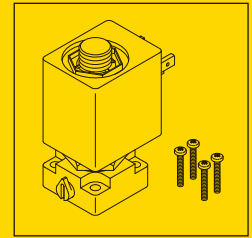

RPI Part #MTC023
OEM Part #MV01-0032



COIL (SOLENOID VALVE)

- 120 VAC 50/60 Hz., 8W (240 W)
- Fits:** Alcohol/Detergent Valves
Models: DSD-201 & DSD Edge

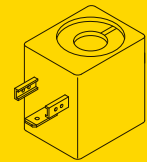

RPI Part #MTK021
OEM Part # (No OEM Part # Available)



SOLENOID VALVE REPAIR KIT

- Includes: Plunger, spring, (1 pc) Seal (RPI Part #MTS022), O-Ring, bonnet and pal nut
- Fits:** Alcohol/Detergent Valves
Models: DSD-201 & DSD Edge

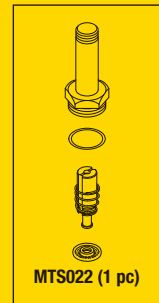

RPI Part #MTV050
OEM Part #MV01-0039



CHECK VALVE

- Cracking Pressure: 5 PSI
 - Ports: 1/4" Push-In
 - Material: White Acetal; Size: .59" dia. x 1.82" lg.
- Fits:** Alcohol and Detergent Lines
Models: DSD-201 & DSD Edge

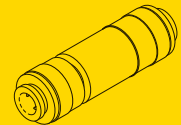

RPI Part #MTV056
OEM Part #MV01-0027



CHECK VALVE

- Cracking Pressure: 10 PSI
 - Ports: 1/4" MPT
 - Material: Brass body, Viton® seal; Size: 9/16 Hex x 1.13" lg.
- Fits:** Air Tank
Models: DSD-201 & DSD Edge

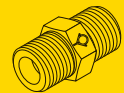

RPI Part #RXV046
OEM Part #MV01-0038



PRESSURE RELIEF VALVE

- Cracking Pressure: 75 PSI
 - Material: Brass; Port: 1/4" MPT
- Fits:** Air Tank
Models: DSD-201 & DSD Edge

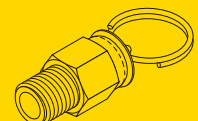



ADDRESS SERVICES REQUESTED

New Line of Parts to fit Medivators® DSD-201® & DSD Edge® AER Systems!

RPI Part #RPF985
OEM Part #ME01-0033



ELBOW FITTING
(5/32" PUSH-IN x #10-32 MALE)

- 5 per package
- Material: Nickel plated brass
- Includes: Sealing O-Ring
- Included in: Valve Block Assembly (RPI Part #'s MTA016 and MTA018)

Fits: #10-32 Female Ports

Models: DSD-201 & DSD Edge



RPI Part #RPF986
OEM Part # (No OEM Part # Available)



MALE CONNECTOR
(5/32" PUSH-IN x #10-32 MALE)

- 5 per package
- Material: Nickel plated brass
- Includes: Sealing O-Ring
- Included in: Valve Block Assembly (RPI Part #'s MTA016 and MTA018)

Fits: #10-32 Female Ports

Models: DSD-201 & DSD Edge

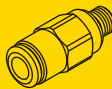

RPI Part #RXF050
OEM Part #MA01-0076
FITTING (3/8" STEM x 1/4" MPT)



- 2 per package
- Material: White Polypropylene
- Included in: Manifold Assembly (8 STN) (RPI Part #MTA038), Manifold (8 STN) (RPI Part #MTA039), Manifold Assembly (6 STN) (RPI Part #MTA040), and Manifold (6 STN) (RPI Part #MTA041)

• See Also available to the right
Fits: 3/8" OD Tubing and 1/4" FPT Port

Models: DSD-201 & DSD Edge

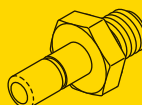

RPI Part #RXF045
OEM Part #ME01-0026



ELBOW FITTING
(3/8" PUSH-IN x 3/8" STEM)

- 2 per package
- Material: White Polypropylene
- See Also available to the right

Fits: 3/8" OD Tubing

Models: DSD-201 & DSD Edge



RPI Part #RXF051
OEM Part #ME01-0027



ELBOW FITTING
(3/8" PUSH-IN x 3/8" PUSH-IN)

- 2 per package
- Material: White Polypropylene
- See Also available to the right

Fits: 3/8" OD Tubing

Models: DSD-201 & DSD Edge



RPI Part #RXF055
OEM Part # (No OEM Part # Available)



FITTING
(1/4" PUSH-IN X 3/8" STEM)

- 2 per package
- Material: White Polypropylene
- See Also available to the right

Fits: 1/4" OD Tubing

Models: DSD-201 & DSD Edge

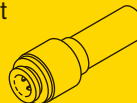

RPI Part #RXF056
OEM Part #MT02-0017



TEE FITTING (3/8" PUSH-IN)

- Material: White Polypropylene
- See Also available to the right

Fits: 3/8" OD Tubing

Models: DSD-201 & DSD Edge

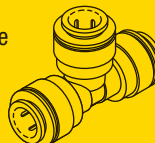

RPI Part #MTR049
OEM Part # (No OEM Part # Available)



RESTRICTOR

- Used to test drain times and simulate the pressure of an active scope.

Fits: Basin Fluid Inlet Line

Models: DSD-201 & DSD Edge

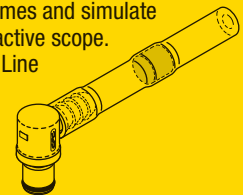

Also available ...

RPI Part #RXC057
OEM Part #ML05-0001



LOCKING CLIPS

- 10 per package
- Material: Red Acetal; Size: 3/8"

Fits: Used to Lock Collets on John Guest 3/8" Push-In Fittings

Models: DSD-201 & DSD Edge



RPI Part #RXT004
OEM Part #47049-157

COLLET RELEASE WRENCH SET

- John Guest collet wrench set
- Sizes: 3/16", 1/4", 5/16", 3/8" and 1/2"
- Also available: Locking Clips (RPI Part #RXC057)

Fits: John Guest Push-In Fittings

Models: DSD-201 & DSD Edge



RPI Part #RXT003
OEM Part #MW03-0002

WRENCH (LOW PROFILE)

- Material: Stainless steel
- Double Ended Flat Wrench: 7/16" x 10mm
- Used to secure the valve stem flat on Medivators pneumatic valve.
- Included in: PM Kit (RPI Part #MTK009) and PM Kit (RPI Part #MTK033)

Models: DSD-201 & DSD Edge

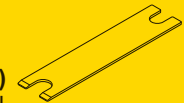

RPI Part #SSS001
OEM Part #201153/200213

INFLATABLE CHAMBER SEAL

- Fabric reinforced EPDM
- Size: 21.57" x 23.06" outside dim.
- Includes all parts as shown

Fits: Chamber Frame Assembly

Models: System 1E & (International Customers only - System 1 90A1, 90A2, 99A1 & 99A2)



SSS001
CROSS SECTION
SHOWN ACTUAL SIZE

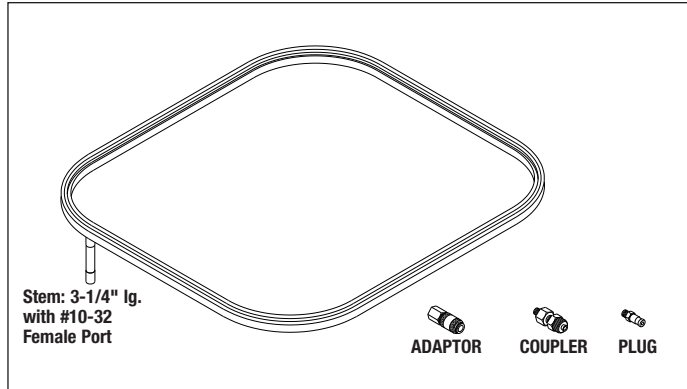

Stem: 3-1/4" lg.
with #10-32
Female Port

ADAPTOR COUPLER PLUG

RPI Part #SSF013
OEM Part #A1501

PREFILTER CARTRIDGE ("A" FILTER)

- 0.2 micron
- Size: 2.68" OD x 9.59" lg.
- Silicone O-ring
- For use in single prefilter system or as filter "A" in dual prefilter system
- Included in Filter Package ("A" & "B") (RPI Part #SSP057)

Models: System 1E & (International Customers only - System 1 89A1, 90A1, 90A2, 90B1, 99A1 & 99A2)

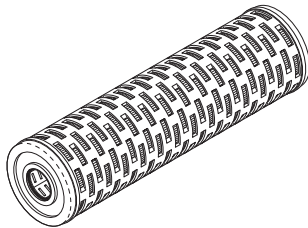

RPI Part #SSF011
OEM Part #A1503

STERILE AIR FILTER

- 0.2 micron
- Size: 2.60" OD x 3.80" lg.; Ports: 3/8" FPT
- 75mm filter media capsule

Fits: Float Block Assembly Air Intake Line

Models: System 1E & (International Customers only - System 1)

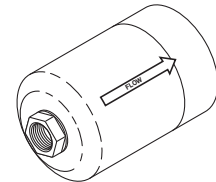

RPI Part #SSF014
OEM Part #A1504

PREFILTER CARTRIDGE ("B" FILTER)

- 0.2 micron
- Size: 2.68" OD x 9.50" lg.
- Silicone O-rings
- For use as filter "B" in dual filter system

Models: (International Customers only - System 1 89A1, 90A1, 90A2, 90B1, 99A1 & 99A2)

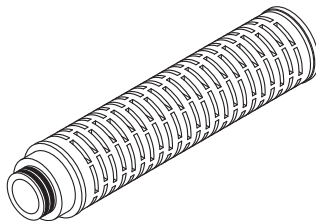

RPI Part #SSF052
OEM Part #A1562

PREFILTER CARTRIDGE ("B" FILTER)

- 0.6 / 0.1 micron dual wrap filter media
- Size: 2.55" OD x 10" lg.
- EPDM O-rings
- Included in Filter Package ("A" & "B") (RPI Part #SSP057)

Fits: External Water Filter Assembly

Model: System 1E

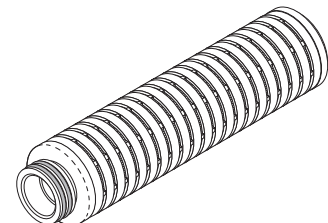

RPI Part #SSF012
OEM Part #A1525

STERILE WATER FILTER

- 0.2 micron
- Size: 2.25" OD x 4.875" lg.
- Silicone O-ring

Fits: Sterile Filter Housing

Models: (International Customers only - System 1 89A1, 90A1, 90A2, 90B1, 99A1 & 99A2)

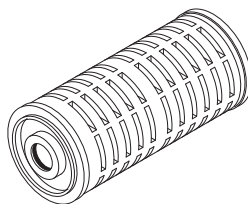

RPI Part #SSP057
OEM Part #A1567

FILTER PACKAGE ("A" & "B")

- Includes all parts as shown

Fits: Pre-Filter Assembly

Model: System 1E

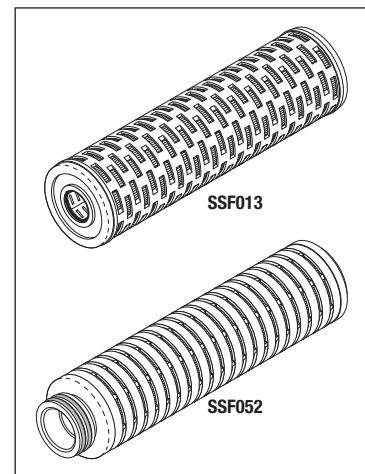

Scope Processing Systems

Models: System 1E® & (International Customers only - System 1® 89A1, 90A1, 90A2, 90B1, 99A1 & 99A2)

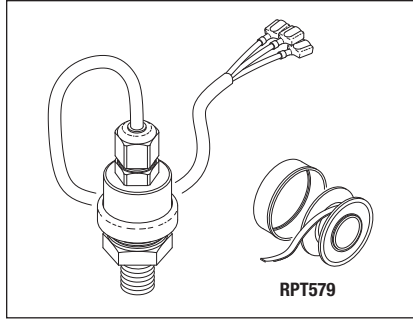

RPI Part #SST046
OEM Part #200141

PRESSURE TRANSDUCER

- Port: 1/8" MPT
- Input voltage: 9-30 VDC; Output voltage: 1-6 VDC
- Material: 316 stainless steel
- Pressure range: 0-100 psig
- Includes: 1/4" Teflon® Thread Sealing Tape (RPI Part #RPT579) and (3) 1/4" Quick Disconnect

Fits: Sterile Filter Housing Assembly
Models: (International Customers only - System 1 89A1 & 90B1)

RPI Part #RPL615
OEM Part #400035



O-RING LUBRICANT

- 2 oz. tube
- Non-Toxic; Super-O-Lube® made by Parker
- Temperature Range: -65° to 400° F
- Included in O-Ring Kit for Servicing Steris® System 1® Sterile Processing System (RPI Part #SSK050)
- Can be used on Silicone and non-silicone rubber materials

Models: System 1E & (International Customers only - System 1)

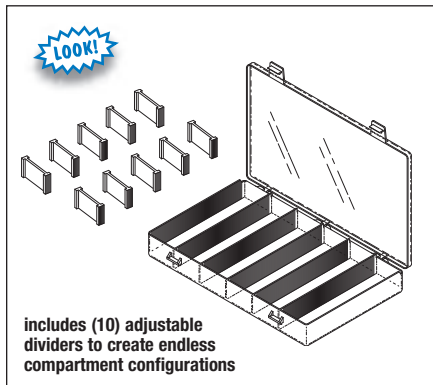

includes (10) adjustable dividers to create endless compartment configurations

STORAGE CASE
RPI Part #RPC616
OEM Part # (No OEM Part # Available)

- (6) standard compartments (1-11/16" w x 6-3/16" lg.) with (10) adjustable dividers
 - 10-1/2" w x 6-3/16" lg. x 1-9/16" d
 - Material: Translucent polypropylene
- Models:** System 1E & (International Customers only - System 1)

RPI Part #SSB042
OEM Part #100209



DRAIN VALVE BUSHING

- Size: 2.44" OD x .75" tall
- Closed cell silicone sponge

Fits: Drain Section on All Trays

Models: System 1E & (International Customers only - System 1 89A1, 90A1, 90A2, 90B1, 99A1 & 99A2)

FILTER SCREEN

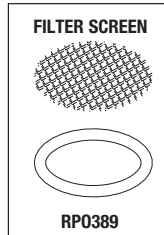

RP0389

RPI Part #SSK035

OEM Part # (No OEM Part # Available)

FILTER SCREEN & O-RING KIT

- Includes all parts as shown

Fits: Drain Section of Instrument Tray

Models: (International Customers only - System 1 89A1, 90A1, 90A2, 90B1, 99A1 & 99A2)

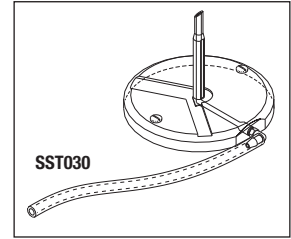

SST030

RPI Part #SSA029
OEM Part #A1600

STERILANT ASPIRATOR ASSEMBLY

- Material: 3-1/4" OD clear Lexan™
- Includes: (5-5/8" lg. piece) Silicone Tubing (RPI Part #SST030)

Fits: Instrument Trays

Models: System 1E & (International Customers only - System 1 89A1, 90A1, 90A2, 90B1, 99A1 & 99A2)

RPI Part #SST030
OEM Part #

(No OEM Part # Available)

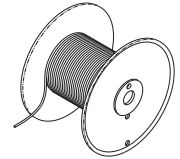

SILICONE TUBING

- .125" ID x .250" OD
- Sold by the foot, reel **NOT** included
- Medical grade Silicone

Fits: Sterilant Aspirator Assembly

Models: System 1E & (International Customers only - System 1 89A1, 90A1, 90A2, 90B1, 99A1 & 99A2)

RPI Part #SSK050

OEM Part # (No OEM Part # Available)

O-RING KIT FOR SERVICING STERIS® SYSTEM 1® STERILE PROCESSING SYSTEM

- Includes: 15-compartment Storage Case (RPI Part #RPC616), O-ring Lubricant (RPI Part #RPL615) and O-ring Removal Tools (RPI Part #RPK581)
- O-rings are also sold separately in reorder quantities

Models: System 1E & (International Customers only - System 1)

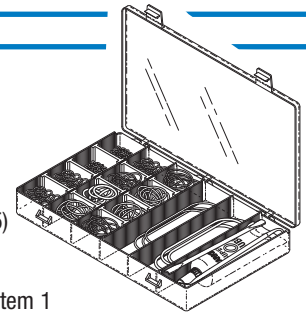

RPI PART #	STERIS PART #	X-SEC	ID	OD	MATERIAL	DURO	KIT QTY	REORDER QTY
RP0307	450617	.070	.114	.254	EPDM	70	12	12
RP0354	450609	.070	.926	1.066	Silicone	70	12	6
RP0388	450610	.070	.426	.566	Silicone	70	12	6
RP0389	450608	.103	1.049	1.255	Silicone	70	12	6
RP0390	450614	.070	1.114	1.254	Silicone	70	12	6
RP0450	450621	.051	.547	.649	Silicone	70	12	6
RP0605	450600	.103	1.174	1.380	Silicone	70	12	12
RP0606	450601	.139	.859	1.137	Silicone	70	12	12
RP0607	450605	.070	1.239	1.379	Silicone	70	12	12
RP0608	450606	.070	.489	.629	Silicone	70	12	12
RP0609	450611	.070	.114	.254	Silicone	70	12	12
RP0610	450612	.103	.924	1.130	Silicone	70	12	12
RP0612	450620	3mm	80mm	86mm	Silicone	60	3	3
RP0613	450622	.139	3.484	3.762	Viton	70	3	3

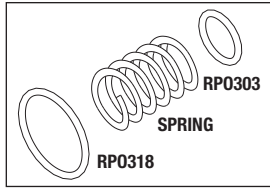

RPI Part #SSK034
OEM Part #200696

CHECK VALVE REPAIR KIT (CK-8)

- Includes all parts as shown
- Material: Stainless steel spring; Buna N (Nitrile) O-rings

Fits: CK-8 Check Valve

Models: System 1E & (International Customers only - System 1 89A1, 90A1, 90A2, 90B1, 99A1 & 99A2)



RPI Part #SSP054
OEM Part #P764335-393

PM PACKAGE (CHECK VALVE)

- Includes all parts as shown
- Models:** System 1E & (International Customers only - System 1)

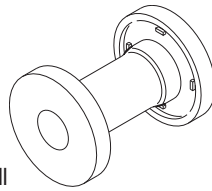
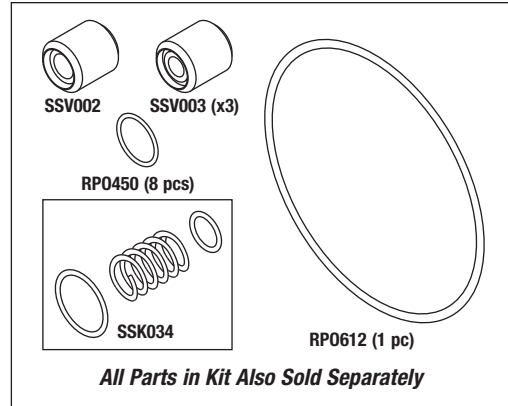

RPI Part #SSS007
OEM Part #400420

PINCH VALVE SLEEVE

- Size: 1.73" OD x 2.39" tall
- Material: Red Silicone

Fits: Pinch Valves

Models: System 1E & (International Customers only - System 1 89A1, 90A1, 90A2, 90B1, 99A1 & 99A2)

RPI Part #SSK008
OEM Part #400696

CHECK VALVE REBUILD KIT (CK-8)

- Includes all parts as shown

Fits: Drain Valve
Models: System 1E & (International Customers only - System 1 89A1, 90A1, 90A2, 90B1, 99A1 & 99A2)

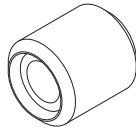
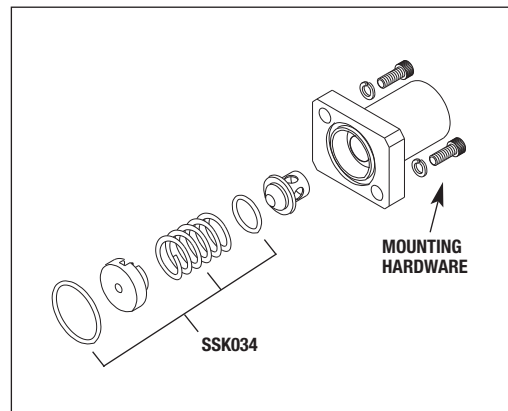

RPI Part #SSV002
OEM Part #400345

CHECK VALVE (CK-1)

- Size: .614" OD x .640" lg.
- Material: Stainless steel
- Also available: O-Ring (RPI Part #RP0450)

Fits: Air Inlet Valve

Models: System 1E & (International Customers only - System 1 89A1, 90A1, 90A2, 90B1, 99A1 & 99A2)

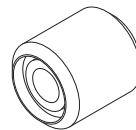

RPI Part #SSV003
OEM Part #400510

CHECK VALVE (CK-2, 3 & 11)

- Size: .614" OD x .640" lg.
- Material: Stainless steel
- Also available: O-Ring (RPI Part #RP0450)

Fits: Float Block Drain Assembly

Models: System 1E & (International Customers only - System 1 89A1, 90A1, 90A2, 90B1, 99A1 & 99A2)

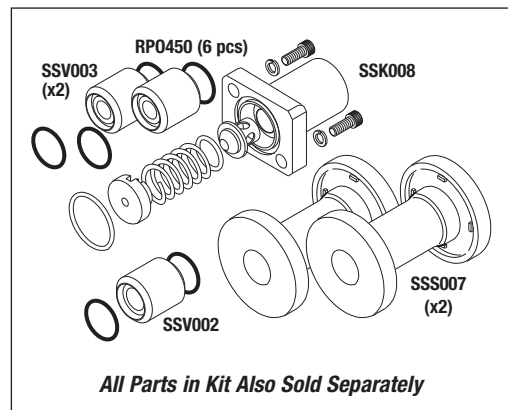

RPI PART #SSK038
OEM Part #200687

MAJOR PM KIT #1

- Includes all parts as shown
- Models:** (International Customers only - System 1 89A1, 90A1, 90A2, 90B1, 99A1 & 99A2)

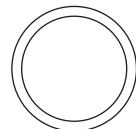

RPI Part #RP0450
OEM Part #45621
Industry Part #5-001

O-RING

- 6 per package
 - Size: .547" ID x .649" OD x .051" C/S
 - Material: Silicone, Duro: 70
- Fits:** CK 2 & 3 on Float Block Assembly and Check Valve (CK-1)

Models: System 1E & (International Customers only - System 1 89A1, 90A1, 90A2, 90B1, 99A1 & 99A2)

Shown Actual Size

RPI PART #SSK039
OEM Part #200975

MAJOR PM KIT #2

- Includes all parts as shown
- Models:** (International Customers only - System 1 89A1, 90A1, 90A2, 90B1, 99A1 & 99A2)

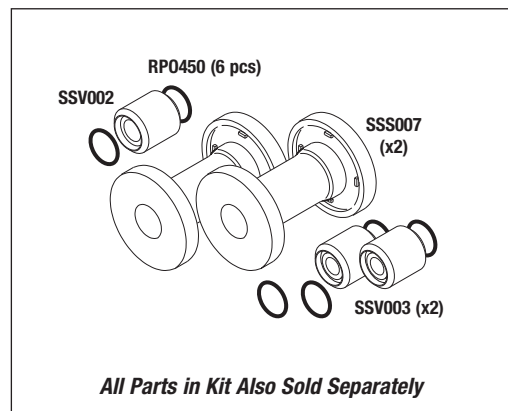

Scope Processing Systems

Models: System 1E® & (International Customers only - System 1® 89A1, 90A1, 90A2, 90B1, 99A1 & 99A2)

RPI Part #SSV055
OEM Part #400774

CHECK VALVE (CK-5, 6, 7)

- Size: .623" OD x .574" lg.
- Material: Stainless steel body; EPDM O-rings
- Includes all parts as shown

Fits: Air Manifold
Model: System 1E

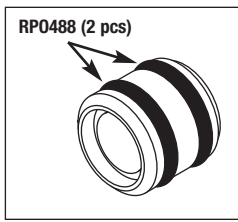

NEW PART

RPO488 (2 pcs)

RPI Part #SSV056
OEM Part #400219

CHECK VALVE (ANTI-SYPHON) (CK-10)

- Size: 3/4" hex x 1-3/4" lg.
- Cracking pressure: 0.11 PSI
- Material: PVDF body; Silicone seal
- Ports: 1/4" FPT

Fits: Vent Line: Drip Pan to Drain Block
Model: System 1E

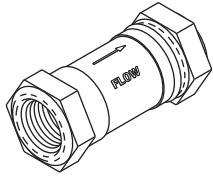

NEW PART

RPI Part #SSV004
OEM Part #400390

CHECK VALVE (CK-5, 6 & 7)

- Size: .620" OD x .572" lg.
- Includes: Check Valve O-Ring Kit (RPI Part #SSK036)

Fits: Air Manifold Assembly
Models: (International Customers only - System 1 89A1, 90A1, 90A2, 90B1, 99A1 & 99A2)

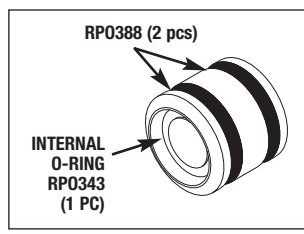

RPO388 (2 pcs)

INTERNAL O-RING RPO343 (1 PC)

RPI Part #SSK006
OEM Part #200226

CHECK VALVE KIT

- Includes all parts as shown
- Used on units with brass Kepner Check Valve

Models: System 1E & (International Customers only - System 1 89A1, 90A1, 90A2, 90B1, 99A1 & 99A2)

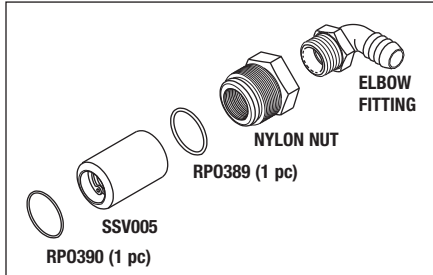

ELBOW FITTING

NYLON NUT

RPO389 (1 pc)

SSV005

RPO390 (1 pc)

RPI Part #SSK036
OEM Part # (No OEM Part # Available)

CHECK VALVE O-RING KIT

- Includes all parts as shown
- Material: 70 Duro

Fits: Check Valve (RPI Part #SSV004) only
Models: System 1E & (International Customers only - System 1 89A1, 90A1, 90A2, 90B1, 99A1 & 99A2)

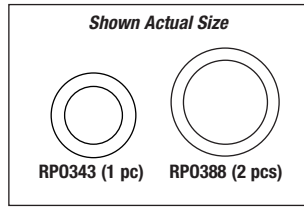

Shown Actual Size

RPO343 (1 pc) RPO388 (2 pcs)

RPI Part #SSV005
OEM Part #400368

CHECK VALVE (CK-4)

- Material: Stainless steel

Fits: Sterile Filter Housing
Models: System 1E & (International Customers only - System 1 89A1, 90A1, 90A2, 90B1, 99A1 & 99A2)

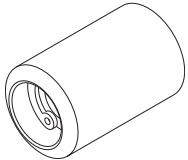

RPI Part #RPO307
OEM Part #450617
Industry Part #AS568-006 / 2-006

O-RING

- 12 per package
- Size: .114" ID x .254" OD x .070" C/S
- Material: EPDM; 70 Duro

Fits: Air Manifold Assembly
Models: (International Customers only - System 1 89A1, 90A1, 90A2, 90B1, 99A1 & 99A2)



Shown Actual Size

RPI Part #SSK010
OEM Part #200056

GAS SPRING ASSEMBLY

- Includes all parts as shown

Fits: Lid Assembly
Models: System 1E & (International Customers only - System 1 89A1, 90A1, 90A2, 90B1, 99A1 & 99A2)

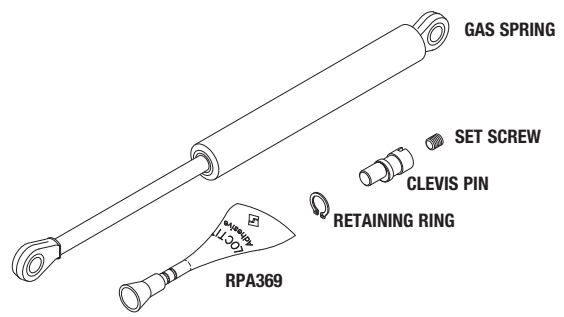

GAS SPRING

SET SCREW

CLEVIS PIN

RETAINING RING

RPA369

Since 1972, healthcare professionals have relied on RPI for quality replacement parts.

RPI Part #SSK010
OEM Part #200056

GAS SPRING ASSEMBLY

- Includes all parts as shown

Fits: Lid Assembly
Models: System 1E & (International Customers only - System 1 89A1, 90A1, 90A2, 90B1, 99A1 & 99A2)

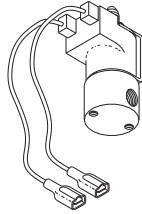

RPI Part #SSV017
OEM Part #200188

SOLENOID VALVE ASSEMBLY (SOL-1)

- 24VAC, 60Hz, 6W
- Fits:** Air Manifold Assembly
- Models:** System 1E & (International Customers only - System 1 90A1, 90A2, 99A1 & 99A2)

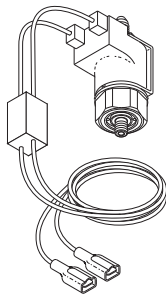

RPI Part #SSV019
OEM Part #200189

SOLENOID VALVE ASSEMBLY (SOL-2, 3 & 4)

- 24VAC, 60Hz, 6W
- SOL-2 Seal Release
- SOL-3 Circulation Pinch Valve
- SOL-4 Drain Pinch Valve
- Fits:** Air Manifold Assembly
- Models:** System 1E & (International Customers only - System 1 90A1, 90A2, 99A1 & 99A2)

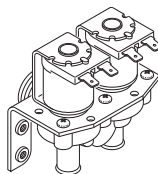

RPI Part #SSV024
OEM Part #200154

DUAL WATER INLET VALVE (SOL-5 & 7)

- 24VAC; N. C.
- Fits:** Mounts to Machine Chassis
- Models:** System 1E & (International Customers only - System 1 90A1, 90A2, 99A1 & 99A2)

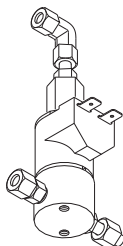

RPI Part #SSV021
OEM Part #200534

SOLENOID VALVE ASSEMBLY (SOL-8)

- 24VAC, 60Hz, 7W
- Includes: Fittings
- Fits:** Sterile Filter Housing
- Models:** (International Customers only - System 1 90A1, 90A2, 99A1 & 99A2)

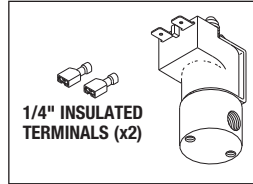

RPI Part #SSV018
OEM Part #500023

SOLENOID VALVE ASSEMBLY (SOL-1)

- 120VAC, 60Hz, 6W
- Includes all parts as shown
- Fits:** Air Manifold Assembly
- Models:** (International Customers only - System 1 89A1 & 90B1)

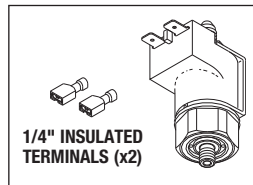

RPI Part #SSV020
OEM Part #500016

SOLENOID VALVE ASSEMBLY (SOL-2, 3 & 4)

- 120VAC, 60Hz, 6W
- Includes all parts as shown
- SOL-2 Seal Release
- SOL-3 Circulation Pinch Valve
- SOL-4 Drain Pinch Valve
- Fits:** Air Manifold Assembly
- Models:** (International Customers only - System 1 89A1 & 90B1)

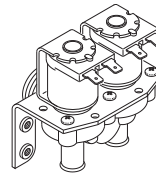

RPI Part #SSV023
OEM Part #200051

DUAL WATER INLET VALVE (SOL-5 & 7)

- 120VAC; N.C.
- Fits:** Mounts to Machine Chassis
- Models:** (International Customers only - System 1 89A1 & 90B1)

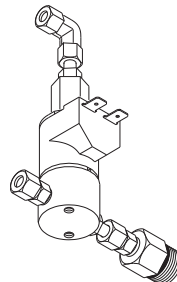

RPI Part #SSV022
OEM Part #200533

SOLENOID VALVE ASSEMBLY (SOL-8)

- 120VAC, 60Hz, 7W
- Includes: Fittings
- Fits:** Sterile Filter Housing
- Models:** (International Customers only - System 1 89A1 & 90B1)

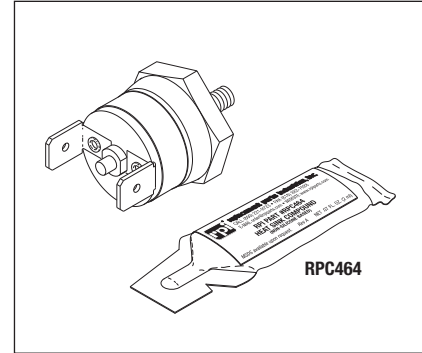

RPI Part #SST033
OEM Part #500019

LS-1 THERMAL CUT OFF SWITCH

- Includes: (One tube) Heat Sink Compound (RPI Part #RPC464)
- Opens @ 79°C (174°F); Manual reset
- 1/4" tabs
- Fits:** Heater Housing
- Models:** System 1E & (International Customers only - System 1 89A1, 90A1, 90A2, 90B1, 99A1 & 99A2)

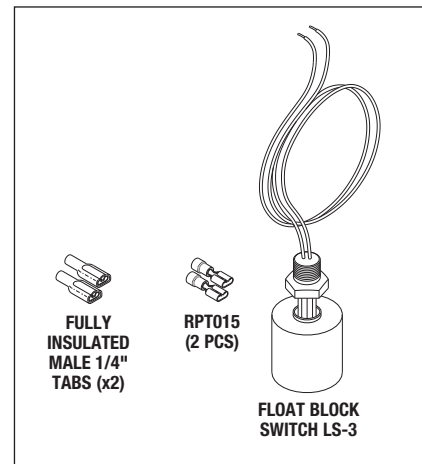

RPI Part #MDS017
OEM Part #90000

FLOAT SWITCH

- 24" lg. leads
- Includes all parts as shown
- Fits:** Float Block Assembly
- Models:** (International Customers only - System 1 89A1, 90A1, 90A2, 90B1, 99A1 & 99A2)

RPI is your BEST source for replacement parts!

New line of parts to fit ...

STERIS® AMSCO® V-PRO®

Low Temperature Sterilization Systems

RPI Part #SSP058
OEM Part #P764333-354



PM PACK (GENERAL)

- Includes: HEPA Filter (RPI Part #SSF059), (4) Exhaust Filter (RPI Part #SSF060), (1 pc) Male Nut (1/8" OD Tubing) (RPI Part #RXF073), (1 pc) Ferrule (1/8" OD Tubing) (RPI Part #RXF074), Tee (1/8" OD Tubing) (RPI Part #RXF075), Battery (Lithium) (RPI Part #RXB076), Air Intake Filter (RPI Part #CMF282), Filter Element (RPI Part #SSE061), Solenoid Valve Repair Kit For 1/4" Port Valves (RPI Part #AMK175), and (2) Isolation Valve (3-Way) (RPI Part #SSV062)
 - Also available: PM Pack (Vacuum) (RPI Part #SSP065)
- Models:** V-PRO 1, V-PRO 1+ & V-PRO maX



RPI Part #SSP065
OEM Part #P764334-481



PM PACK (VACUUM)

- Includes: Air Intake Filter (Metal Style) (RPI Part #CMF002), Exhaust Filter (RPI Part #SSF060), Filter Element (RPI Part #SSE066), (2) Cartridge Filter (RPI Part #SSF067), (1 pc) Disposal Bag (RPI Part #RPB838), (5 pcs) Absorbent Pad (RPI Part #RPP958), (3) Vacuum Pump Oil (Leybold Pump) (RPI Part #RXL034), and Drain Plug Gasket (RPI Part #SSG068)
 - All parts also sold separately
 - Also available: PM Pack (General) (RPI Part #SSP058)
- Models:** V-PRO 1, V-PRO 1+ & V-PRO maX



RPI Part #SSP063
OEM Part #P764335-558



PM PACK (GENERAL)

- Includes: HEPA Filter (RPI Part #SSF059), (1 pc) Male Nut (1/8" OD Tubing) (RPI Part #RXF073), (1 pc) Ferrule (1/8" OD Tubing) (RPI Part #RXF074), and (1 pkg) Filter (RPI Part #SSF064).
 - All parts also sold separately
- Model:** V-PRO 60





RPI Part #SSV062
OEM Part #P093940-125

Isolation Valve (3-Way)

- 24VDC, 1.5W; 19.70" lg.
 - #24 AWG wires
 - Ports: 1/4-28; 3-Way
 - Included in: PM Pack (General) (RPI Part #SSP058)
- Fits:** Injection Assembly
Models: V-PRO 1, V-PRO 1+ & V-PRO maX



RPI Part #SSW072
OEM Part #P129603-014

SEALING WASHER

- 2 per package
 - Material: Red Silicone
 - Size: .290" ID x .688" OD x .093" thk
- Fits:** Oil Mist Eliminator
Models: V-PRO 60



x2

RPI Part #RXF075
OEM Part #P387348-974

TEE (1/8" OD TUBING)

- 1/4-28 for 1/8" OD tubing fitting
 - Material: PEEK®
 - Included in: PM Pack (General) (RPI Part #SSP058)
- Fits:** Hydrogen Peroxide Delivery System
Models: V-PRO 1, V-PRO 1+, V-PRO 60 & V-PRO maX



RPI Part #RXL034
OEM Part #P764334-644, P764335-529, P764335-529

VACUUM PUMP OIL (LEYBOLD PUMP)

- 1 liter (32 fl. oz.) bottle
 - Molykote L-1668 FM oil
 - Includes: Yorker spout
 - Included in: PM Pack (Vacuum) (RPI Part #SSP065)
 - Also available: Bottle (1 liter/32 fl. oz.) (RPI Part #RPB939), Disposal Bag (RPI Part #RPB838) and Absorbent Pad (RPI Part #RPP958)
- Fits:** Vacuum Pump
Models: V-PRO 1, V-PRO 1+, V-PRO 60 & V-PRO maX



RPI Part #RXF073
OEM Part #P387349-030

MALE NUT (1/8" OD TUBING)

- 6 per package
 - 1/4-28 x .61" lg for 1/8" OD tubing
 - Material: PEEK®
 - Included in: PM Pack (General) (RPI Part #'s SSP058 and SSP063)
- Fits:** Hydrogen Peroxide Delivery System
Models: V-PRO 1, V-PRO 1+, V-PRO 60 & V-PRO maX



x6

RPI Part #AMK175
OEM Part #P910009-024

SOLENOID VALVE REPAIR KIT FOR 1/4" PORT VALVES

- For 1/4" port valves
 - Includes all parts as shown
 - Included in: PM Pack (General) (RPI Part #SSP058)
- Fits:** Solenoid Valve
Models: V-PRO 1, V-PRO 1+ & V-PRO maX



RPI Part #RXF074
OEM Part #P387349-031

FERRULE (1/8" OD TUBING)

- 6 per package
 - For 1/8" OD tubing
 - Material: Tefzel®
 - Included in: PM Pack (General) (RPI Part #'s SSP058 and SSP063)
- Fits:** Hydrogen Peroxide Delivery System
Models: V-PRO 1, V-PRO 1+, V-PRO 60 & V-PRO maX

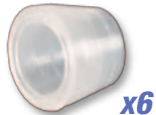

x6

RPI Part #SSD071
OEM Part #P129603-002

DIAPHRAGM (VALVE UMBRELLA)

- Material: Blue Silicone
 - Size: 18mm (.709") OD x 14.3mm (.563") lg.
- Fits:** Oil Mist Eliminator
Model: V-PRO 60



RPI Part #RXB076
OEM Part #P764332-350

BATTERY (LITHIUM)

- 3VDC Lithium
 - Size: .62" dia x 1.00" lg
 - Caution: Do not use if the battery is crushed or punctured.
 - Contact your state and local agencies for hazardous waste to determine proper disposal methods.
 - Included in: PM Pack (General) (RPI Part #SSP058)
- Fits:** Control Box Assembly
Models: V-PRO 1, V-PRO 1+ & V-PRO maX



RPI Part #SSG068
OEM Part #P764332-377

DRAIN PLUG GASKET

- Material: Viton®
 - Size: .615" ID x .875" OD x .080" thk
 - Included in: PM Pack (Vacuum) (RPI Part #SSP065)
- Fits:** Oil Mist Eliminator
Models: V-PRO 1, V-PRO 1+ & V-PRO maX



RPI Part #RXT077

OEM Part # (No OEM Part # Available)

TUBING (5/16" ID X 9/16" OD CLEAR)

- Sold by the foot
- Material: Industrial Grade PVC (Non-Food Grade)

Fits: Vacuum Pump Drain Use Only

Model: V-PRO 60



RPI Part #CMF002

OEM Part #P129385-485

AIR INTAKE FILTER (METAL STYLE)

- Size: 1.84" OD x 3.63" lg.
- Auto Muffler MO2
- Included in: PM Pack (General) (RPI Part #SSP058)

Models: V-PRO 1, V-PRO 1+ & V-PRO maX

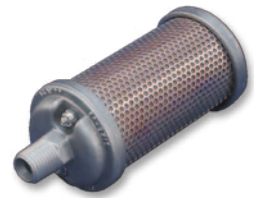

RPI Part #SSF067

OEM Part #P764334-369

CARTRIDGE FILTER

- 0.3 micron
- Size: 2.78" OD x 7.87" lg.
- Includes: Filter and (2) O-rings
- Included in: PM Pack (Vacuum) (RPI Part #SSP065)

Fits: Oil Mist Eliminator

Models: V-PRO 1, V-PRO 1+, V-PRO 60 & V-PRO maX



RPI Part #SSF060

OEM Part #P129385-276

EXHAUST FILTER

- Size: .67" dia x 1.50" lg; 1/4" MPT
- Included in: PM Pack (General) (RPI Part #SSP058) and PM Pack (Vacuum) (RPI Part #SSP065)

Fits: Auto Drain Assembly

Models: V-PRO 1, V-PRO 1+ & V-PRO maX



RPI Part #SSF059

OEM Part #P101006-172

HEPA FILTER

- 1.2 micron
- Size: 2.50" OD x 7.60" lg.
- Ports: 3/8" FPT with 1/2" Barbs
- Included in: PM Pack (General) (RPI Part #'s SSP058 and SSP063)

Fits: Air Intake

Models: V-PRO 1, V-PRO 1+, V-PRO 60 & V-PRO maX



RPI Part #SSE066

OEM Part #P764334-368

FILTER ELEMENT

- 10 micron
- Size: 7.87" OD x 9.62" lg.
- Included in: PM Pack (Vacuum) (RPI Part #SSP065)

Fits: Air Intake

Models: V-PRO 1, V-PRO 1+ & V-PRO maX



RPI Part #SSE061

OEM Part #P764333-215

FILTER ELEMENT

- 20 micron
- Size: .81" OD x .55" ID x 1.22" lg.
- Included in: PM Pack (General) (RPI Part #SSP058)

Fits: Air Intake

Models: V-PRO 1, V-PRO 1+ & V-PRO maX



RPI Part #CMF282

OEM Part #P764333-087

AIR INTAKE FILTER

- 50 Microns
- Size: 2" dia. x 3.40" lg. x 1/4" MPT
- Includes: Air Filter Element (RPI Part #CME288)
- Included in: PM Pack (General) (RPI Part #SSP058)

Fits: Compressor

Models: V-PRO 1, V-PRO 1+ & V-PRO maX



RPI Part #RPB838

OEM Part # (No OEM Part # Available)

DISPOSAL BAG

- 3 per package
- Used oil collection and disposal bag
- Included in: PM Pack (Vacuum) (RPI Part #SSP065)

Models: V-PRO 1, V-PRO 1+, V-PRO 60 & V-PRO maX



RPI Part #CME288

OEM Part # (No OEM Part # Available)

AIR FILTER ELEMENT

- 50 Microns; Size: 1.30" OD x .62" ID x 1.00" lg.
- Included in: Air Intake Filter (RPI Part #CMF282)

Fits: Air Intake Filter Housing

Models: V-PRO 1, V-PRO 1+ & V-PRO maX



RPI Part #RPP958

OEM Part # (No OEM Part # Available)

ABSORBENT PAD

- 3 per package; Size: 9-1/4" x 14-1/2"
- Can be used for oil drip collection and spills
- Included in: PM Pack (Vacuum) (RPI Part #SSP065)

Models: V-PRO 1, V-PRO 1+, V-PRO 60 & V-PRO maX

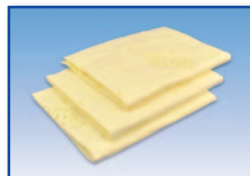

RPI Part #SSF064

OEM Part #P129385-263

FILTER

- 2 per package
- Size: .30" dia x .90" lg; Port: M5 male
- Included in: PM Pack (General) (RPI Part #SSP063)

Fits: Injection Manifold (60), 3-way valve

Models: V-PRO 1, V-PRO 1+, V-PRO 60 & V-PRO maX



New PM Packs to fit STERIS® AMSCO® V-PRO® 1, V-PRO® 1+ & V-PRO® maX!

NEW



PM PACK (GENERAL)

RPI Part #SSP058

NEW



PM PACK (VACUUM)

RPI Part #SSP065

New Parts to fit STERIS® AMSCO® V-PRO® Sterilization Systems!

ADDRESS SERVICES REQUESTED

PERMIT NO. 2399
VAN NUYS, CA
U.S. POSTAGE PAID
PRESORTED STANDARD

replacement parts industries, inc.
625 Cochran Street • Simi Valley, California • 93065



New PM Pack to fit STERIS® AMSCO® V-PRO® 60!

NEW



PM PACK (GENERAL)

RPI Part #SSP063

Look inside for even more new parts to fit STERIS AMSCO V-PRO Low Temperature Sterilization Systems including:

- Battery (Lithium)
- Cartridge Filter
- Diaphragm (Valve Umbrella)
- Drain Plug Gasket
- Isolation Valve (3-Way)
- Exhaust Filter
- Filter Element
- Hepa Filter
- Sealing Washer
- Many More!



... Proud to be a Healthcare Components Group company ...



HEALTHCARE
Components Group

STERIS

New PM Packs and more to fit ...

Steris®

V-Pro®

Low Temperature Sterilization Systems



RPI Part #SSP069
OEM Part #P764335-557

PM PACK (VACUUM)

- Includes: Vacuum Pump Oil (Leybold Pump) (RPI Part #RXLO34), Cartridge Filter (RPI Part #SSF067), Filter Element (RPI Part #SSE070), (1 pc) Disposal Bag (RPI Part #RPB838), Diaphragm (Valve Umbrella) (RPI Part #SSD071), (1 pkg) Sealing Washer (RPI Part #SSW072), and (3 ft.) Tubing (5/16" ID x 9/16" OD Natural) (RPI Part #RXT077)

Models: V-PRO 60 & V-PRO s2



RPI Part #SSP063
OEM Part #P764335-558

PM PACK (GENERAL)

- Includes: HEPA Filter (RPI Part #SSF059), (1 pc) Male Nut (1/8" OD Tubing) (RPI Part #RXF073), (1 pc) Ferrule (1/8" OD Tubing) (RPI Part #RXF074), and (1 pkg) Filter (RPI Part #SSF064)

Models: V-PRO 60 & V-PRO s2



RPI Part #SSP075
OEM Part #P764337-176

PM PACK (VACUUM)

- Includes: (3) Vacuum Pump Oil (Leybold Pump) (RPI Part #RXLO34), (2) Cartridge Filter (RPI Part #SSF067), (2) Filter Element (RPI Part #SSE070), (1 pc) Disposal Bag (RPI Part #RPB838), (2) Diaphragm (Valve Umbrella) (RPI Part #SSD071), (2 pkgs) Sealing Washer (RPI Part #SSW072), Drain Plug Gasket (RPI Part #SSG068), Exhaust Filter (RPI Part #SSF060), (5 pcs) Absorbent Pad (RPI Part #RPP958) and (3 ft.) Tubing (5/16" ID x 9/16" OD Natural) (RPI Part #RXT077)

Models: V-PRO Max 2



RPI Part #SSP058
OEM Part #P764333-354

PM PACK (GENERAL)

- Includes: HEPA Filter (RPI Part #SSF059), (4) Exhaust Filter (RPI Part #SSF060), (1 pc) Male Nut (1/8" OD Tubing) (RPI Part #RXF073), (1 pc) Ferrule (1/8" OD Tubing) (RPI Part #RXF074), Tee (1/8" OD Tubing) (RPI Part #RXF075), Battery (Lithium) (RPI Part #RXB076), Air Intake Filter (RPI Part #CMF282), Filter Element (RPI Part #SSE061), Solenoid Valve Repair Kit For 1/4" Port Valves (RPI Part #AMK175), and (2) Isolation Valve (3-Way) (RPI Part #SSV062)

Models: V-PRO 1, V-PRO 1+ & V-PRO Max



RPI Part #SSP065
OEM Part #P764334-481

PM PACK (VACUUM)

- Includes: Air Intake Filter (Metal Style) (RPI Part #CMF002), Exhaust Filter (RPI Part #SSF060), Filter Element (RPI Part #SSE066), (2) Cartridge Filter (RPI Part #SSF067), (1 pc) Disposal Bag (RPI Part #RPB838), (5 pcs) Absorbent Pad (RPI Part #RPP958), (3) Vacuum Pump Oil (Leybold Pump) (RPI Part #RXLO34), and Drain Plug Gasket (RPI Part #SSG068)

Models: V-PRO 1, V-PRO 1+ & V-PRO Max



replacement parts industries, inc. A Healthcare Components Group Company

CALL (800) 221-9723 • FAX (818) 882-7028 • EMAIL order@ripiparts.com • WEBSITE www.ripiparts.com

The above parts are manufactured by Replacement Parts Industries, Inc. to fit the equipment noted. All product names used in this document are trademarks or registered trademarks of their respective holders. 1908SS R2 2 SHOW 11/22

SECTION

10

PAGE

507

UPDATED

11/22

RPI Part #SSF059
OEM Part #P101006-172

HEPA FILTER

- 1.2 micron
- Size: 2.50" OD x 7.60" lg.
- Ports: 3/8" FPT with 1/2" Barbs
- Included in: PM Pack (General) (RPI Part #'s SSP058 and SSP063)

Fits: Air Intake

Models: V-PRO 1, V-PRO 1+, V-PRO 60, V-PRO Max, V-PRO Max 2 & V-PRO s2



RPI Part #AMK175
OEM Part #P910009-024

SOLENOID VALVE REPAIR KIT FOR 1/4" PORT VALVES

- Includes all parts as shown
- Included in: PM Pack (General) (RPI Part #SSP058)

Fits: Solenoid Valve

Models: V-PRO 1, V-PRO 1+ & V-PRO Max



RPI Part #RXF075
OEM Part #P387348-974

TEE (1/8" OD TUBING)

- 1/4-28 for 1/8" OD tubing fitting; Material: PEEK®
- Included in: PM Pack (General) (RPI Part #SSP058)

Fits: Hydrogen Peroxide Delivery System

Models: V-PRO 1, V-PRO 1+, V-PRO 60, V-PRO Max, V-PRO Max 2 & V-PRO s2



RPI Part #RXF073
OEM Part #P387349-030

MALE NUT (1/8" OD TUBING)

- 6 per package
- 1/4-28 x .61" lg for 1/8" OD tubing; Material: PEEK®
- Included in: PM Pack (General) (RPI Part #'s SSP058 and SSP063)

Fits: Hydrogen Peroxide Delivery System

Models: V-PRO 1, V-PRO 1+, V-PRO 60, V-PRO Max, V-PRO Max 2 & V-PRO s2



RPI Part #RXF074
OEM Part #P387349-031

FERRULE (1/8" OD TUBING)

- 6 per package
- For 1/8" OD tubing; Material: Tefzel®
- Included in: PM Pack (General) (RPI Part #'s SSP058 and SSP063)

Fits: Hydrogen Peroxide Delivery System

Models: V-PRO 1, V-PRO 1+, V-PRO 60, V-PRO Max, V-PRO Max 2 & V-PRO s2

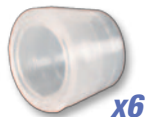

RPI Part #SSF064
OEM Part #P129385-263

FILTER

- 2 per package
- Size: .30" dia. x .90" lg; Port: M5 male
- Included in: PM Pack (General) (RPI Part #SSP063)

Fits: Injection Manifold (60), 3-way valve (1, 1+, and Max)

Models: V-PRO 1, V-PRO 1+, V-PRO 60, V-PRO Max, V-PRO Max 2 & V-PRO s2



RPI Part #SSV062
OEM Part #P093940-125

ISOLATION VALVE (3-WAY)

- 24VDC, 1.5W; 19.70" lg. #24 AWG wires
- Ports: 1/4-28; 3-Way
- Included in: PM Pack (General) (RPI Part #SSP058)

Fits: Injection Assembly

Models: V-PRO 1, V-PRO 1+ & V-PRO Max



RPI Part #RXB076
OEM Part #P764332-350

BATTERY (LITHIUM)

- 3VDC Lithium; Size: .62" dia x 1.00" lg
- Included in: PM Pack (General) (RPI Part #SSP058)

Fits: Control Box Assembly

Models: V-PRO 1, V-PRO 1+ & V-PRO Max



RPI Part #SSE061
OEM Part #P764333-215

FILTER ELEMENT

- 20 micron; Size: .81" OD x .55" ID x 1.22" lg.
- Included in: PM Pack (General) (RPI Part #SSP058)

Fits: Air Intake

Models: V-PRO 1, V-PRO 1+ & V-PRO Max



RPI Part #CMF282
OEM Part #P764333-087

AIR INTAKE FILTER

- 50 Microns
- Size: 2" dia. x 3.40" lg. x 1/4" MPT
- Includes: Air Filter Element (RPI Part #CME288)

• Included in: PM Pack (General) (RPI Part #SSP058)

Fits: Compressor

Models: V-PRO 1, V-PRO 1+ & V-PRO Max



RPI Part #CME288
OEM Part # (No OEM Part # Available)

AIR FILTER ELEMENT

- 50 Microns; Size: 1.30" OD x .62" ID x 1.00" lg.
- Included in: Air Intake Filter (RPI Part #CMF282)

Fits: Air Intake Filter Housing

Models: V-PRO 1, V-PRO 1+ & V-PRO Max



RPI Part #SSF060
OEM Part #P129385-276

EXHAUST FILTER

- Size: .67" dia x 1.50" lg; 1/4" MPT
- Included in: PM Pack (General) (RPI Part #SSP058) and PM Pack (Vacuum) (RPI Part #'s SSP065 & SSP075)

Fits: Auto Drain Assembly

Models: V-PRO 1, V-PRO 1+, V-PRO Max & V-PRO Max 2



RPI Part #SSE070
OEM Part #P093940-310



FILTER ELEMENT

- Size: 6.83" OD x 7.12" lg.
- Oil vapor and odor removing activated carbon
- Included in: PM Pack (Vacuum) (RPI Part #'s SSP069 & SSP075)

Fits: Vacuum Exhaust Assembly

Models: V-PRO 60, V-PRO s2 & V-PRO Max 2



RPI Part #RXT077
OEM Part #P764335-465

TUBING (5/16" ID X 9/16" OD CLEAR)

- Sold by the foot
- Material: Industrial Grade PVC (Non-Food Grade)
- Included in: PM Pack (Vacuum) (RPI Part #'s SSP069 & SSP075)

Fits: Vacuum Pump Drain Use Only

Models: V-PRO 60, V-PRO s2 & V-PRO Max 2



RPI Part #SSD071
OEM Part #P129603-002

DIAPHRAGM (VALVE UMBRELLA)

- Material: Blue Silicone
- Size: 18mm (.709") OD x 14.3mm (.563") lg.
- Included in: PM Pack (Vacuum) (RPI Part #'s SSP069 & SSP075)

Fits: Oil Mist Eliminator

Models: V-PRO 60, V-PRO s2 & V-PRO Max 2



RPI Part #SSW072
OEM Part #P129603-014

SEALING WASHER

- 2 per package
- Material: Red Silicone
- Size: .290" ID x .688" OD x .093" thk
- Included in: PM Pack (Vacuum) (RPI Part #'s SSP069 & SSP075)

Fits: Oil Mist Eliminator

Models: V-PRO 60, V-PRO s2 & V-PRO Max 2

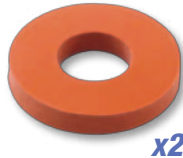

RPI Part #SSE066
OEM Part #P764334-368

FILTER ELEMENT

- 10 micron; Size: 7.87" OD x 9.62" lg.
- Included in: PM Pack (Vacuum) (RPI Part #SSP065)

Fits: Air Intake

Models: V-PRO 1, V-PRO 1+ & V-PRO Max



RPI Part #CMF002
OEM Part #P129385-485

AIR INTAKE FILTER (METAL STYLE)

- Size: 1.84" OD x 3.63" lg.
- Auto Muffler MO2
- Included in: PM Pack (Vacuum) (RPI Part #SSP065)

Models: V-PRO 1, V-PRO 1+ & V-PRO Max



RPI Part #SSF067
OEM Part #P764334-369

CARTRIDGE FILTER

- 0.3 micron
- Size: 2.78" OD x 7.87" lg.
- Includes: Filter and (2) O-rings
- Included in: PM Pack (Vacuum) (RPI Part #'s SSP065, SSP069 & SSP075)

Fits: Oil Mist Eliminator

Models: V-PRO 1, V-PRO 1+, V-PRO 60, V-PRO Max, V-PRO Max 2 & V-PRO s2



RPI Part #SSG068
OEM Part #P764332-377

DRAIN PLUG GASKET

- Material: Viton®
- Size: .615" ID x .875" OD x .080" thk
- Included in: PM Pack (Vacuum) (RPI Part #'s SSP065 & SSP075)

Fits: Oil Mist Eliminator

Models: V-PRO 1, V-PRO 1+, V-PRO Max & V-PRO Max 2



RPI Part #RXLO34
OEM Part #P764334-644/P764335-529

VACUUM PUMP OIL (LEYBOLD PUMP)

- 1 liter (32 fl. oz.) bottle
- Molykote L-1668 FM oil
- Includes: Yorker spout
- Included in: PM Pack (Vacuum) (RPI Part #'s SSP065, SSP069 & SSP075)
- Also available: Bottle (1 liter / 32 fl. oz.) (RPI Part #RPB939), Disposal Bag (RPI Part #RPB838) and Absorbent Pad (RPI Part #RPP958)

Fits: Vacuum Pump

Models: V-PRO 1, V-PRO 1+, V-PRO 60, V-PRO Max, V-PRO Max 2 & V-PRO s2



RPI Part #RPB838
OEM Part # (No OEM Part # Available)

DISPOSAL BAG

- 3 per package
- Used oil collection and disposal bag
- Included in: PM Pack (Vacuum) (RPI Part #'s SSP065, SSP069 & SSP075)

Models: V-PRO 1, V-PRO 1+, V-PRO 60, V-PRO Max, V-PRO Max 2 & V-PRO s2



RPI Part #RPP958
OEM Part # (No OEM Part # Available)

ABSORBENT PAD

- 3 per package; Size: 9-1/4" x 14-1/2"
- Can be used for oil drip collection and spills
- Included in: PM Pack (Vacuum) (RPI Part #'s SSP065, SSP069 & SSP075)

Models: V-PRO 1, V-PRO 1+, V-PRO 60, V-PRO Max, V-PRO Max 2 & V-PRO s2

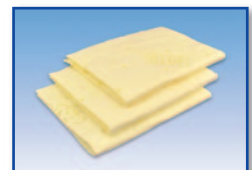

RPI Parts to fit Steris® V-Pro® Low Temperature Sterilization Systems!

RPI Part #	OEM Part #	Description	V-Pro 1	V-Pro 1+	V-Pro 60	V-Pro Max	V-Pro Max 2	V-Pro s2
AMK175	P910009-024	SOLENOID VALVE REPAIR KIT FOR 1/4" PORT VALVES	•	•		•		
CME288	<i>(OEM Part # Not Available)</i>	AIR FILTER ELEMENT	•	•		•		
CMF002	P129385-485	AIR INTAKE FILTER (METAL STYLE)	•	•		•		
CMF282	P764333-087	AIR INTAKE FILTER	•	•		•		
RPB838	<i>(OEM Part # Not Available)</i>	DISPOSAL BAG	•	•	•	•	•	•
RPP958	<i>(OEM Part # Not Available)</i>	ABSORBENT PAD	•	•	•	•	•	•
RXB076	P764332-350	BATTERY (LITHIUM)	•	•		•		
RXF073	P387349-030	MALE NUT (1/8" OD TUBING)	•	•	•	•	•	•
RXF074	P387349-031	FERRULE (1/8" OD TUBING)	•	•	•	•	•	•
RXF075	P387348-974	TEE (1/8" OD TUBING)	•	•	•	•	•	•
RXL034	P764334-644 & P764335-529	VACUUM PUMP OIL (LEYBOLD PUMP)	•	•	•	•	•	•
RXT077	P764335-465	TUBING (5/16" ID X 9/16" OD CLEAR)			•		•	•
SSD071	P129603-002	DIAPHRAGM (VALVE UMBRELLA)			•		•	•
SSE061	P764333-215	FILTER ELEMENT	•	•		•		
SSE066	P764334-368	FILTER ELEMENT	•	•		•		
SSE070	P093940-310	FILTER ELEMENT			•		•	•
SSF059	P101006-172	HEPA FILTER	•	•	•	•	•	•
SSF060	P129385-276	EXHAUST FILTER	•	•		•	•	
SSF064	P129385-263	FILTER	•	•	•	•	•	•
SSF067	P764334-369	CARTRIDGE FILTER	•	•	•	•	•	•
SSG068	P764332-377	DRAIN PLUG GASKET	•	•		•	•	
SSP058	P764333-354	PM PACK (GENERAL)	•	•		•		
SSP063	P764335-558	PM PACK (GENERAL)			•			•
SSP065	P764334-481	PM PACK (VACUUM)	•	•		•		
SSP069	P764335-557	PM PACK (VACUUM)			•			•
SSP075	P764337-176	PM PACK (VACUUM)					•	
SSV062	P093940-125	ISOLATION VALVE (3-WAY)	•	•		•		
SSW072	P129603-014	SEALING WASHER			•		•	•

ANNUAL PM KIT

to fit ADIXEN/
PFEIFFER PUMP

For Leybold Pump
PM Kit see Page 521

RPI Part #SDK003
OEM Part #100798-02

PM-2 KIT (ADIXEN/ PFEIFFER PUMP)

- Annual planned maintenance kit
- Includes all parts as shown and listed in the chart below
- Also available: PM-1 Kit (Adixen/Pfeiffer Pump) (RPI Part #SDK004) - for biannual planned maintenance (see page 524)

Model: NX

Now Includes the
Catalytic Converter!

Also sold separately,
just ask for
RPI Part #SDC005

NOW INCLUDES

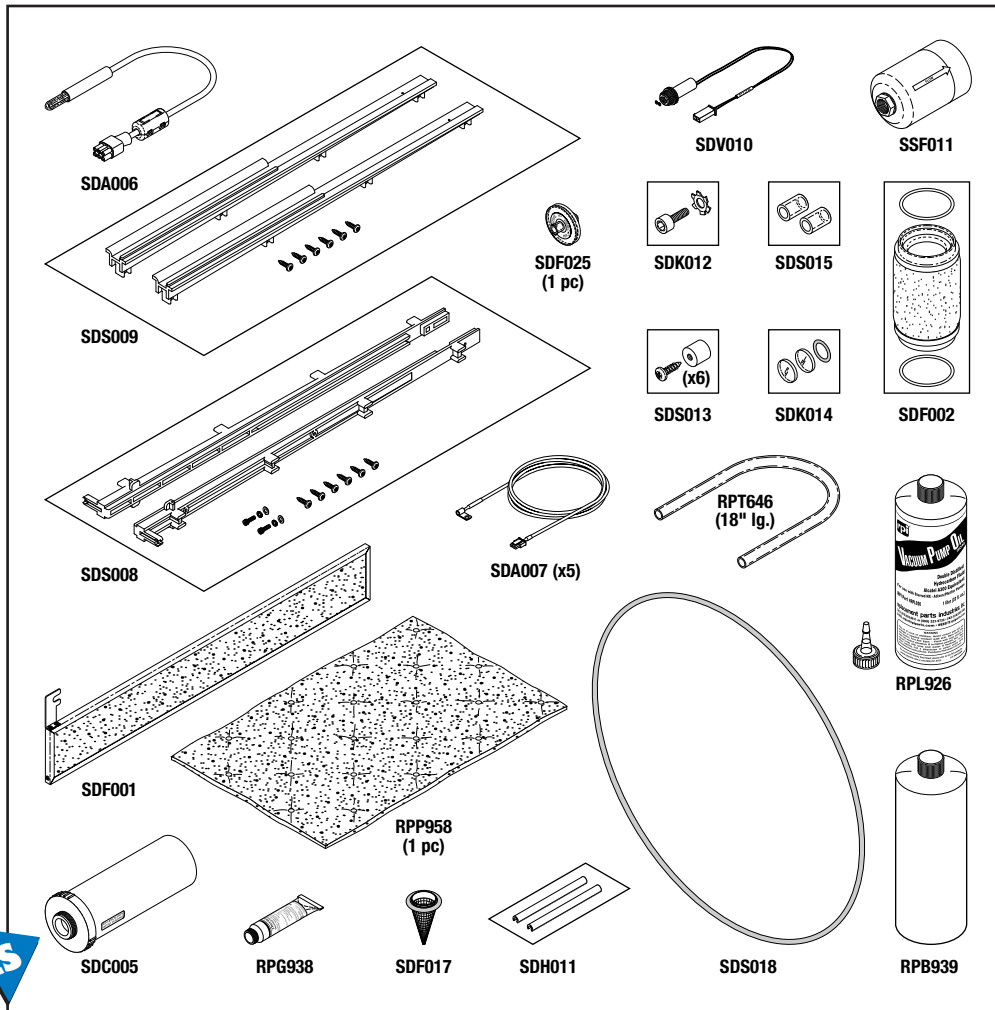

RPI PART #	OEM PART #	DESCRIPTION	KIT QTY	REORDER PKG QTY
SDA006	40-52125-001	UV Lamp Assembly	1	1
SDA007	40-52136-001	Thermistor Assembly	5	1
SDC005	25-05611-0-001	Catalytic Converter	1	1
SDF001	25-52153-001	Air Filter (Base)	1	1
SDF002	25-08560-001	Oil Mist Filter (Red)	1	1
SDF017	100147-01	Conical Screen Filter	1	1
SDF025	25-50703-001	Air Filter (25mm)	1 pc	3
SDH011	33-05440-0-002	Handle (Shelf Extension)	1 Pkg of 2	1 Pkg of 2
SDK012	109522-01	Feedthru Screw Washer Kit	1	1
SDK014	32-51413-0-001/22-00537-209	Optical Window Kit	1	1
SDS008	33-53558-0-001	Shelf Support (Upper)	1 Pkg of 2	1 Pkg of 2
SDS009	33-51152-0-001	Shelf Support (Lower)	1 Pkg of 2	1 Pkg of 2
SDS013	33-51158-0-001	Spacer (Electrode)	1 Pkg of 6	1 Pkg of 6
SDS015	No OEM Part # Available	Sleeve Gasket	1 Pkg of 2	1 Pkg of 2
SDS018	22-00537-385	Chamber/Door Seal	1	1
SDV010	28-53786-001	Delivery Valve	1	1
SSF011	25-51198-001	Sterile Air (HEPA) Filter	1	1
RBP939	No OEM Part # Available	Bottle (1 liter/32 fl. oz.)	1	1
RPG938	No OEM Part # Available	Thermal Grease (Thermalcote™)	1	1
RPL926	37-00579-003	Vacuum Pump Oil (Adixen/Pfeiffer Pump)	1	1
RPP958	No OEM Part # Available	Absorbent Pad	1 pc	3
RPT646	No OEM Part # Available	Tubing (3/8" ID x 1/2" OD Clear)	18"	Per Foot

Sterilization Systems

Models: NX, 100NX & 100S (continued)

ANNUAL PM KIT to fit LEYBOLD PUMP

For Adixen/Pfeiffer Pump
PM Kit see Page 520



RPI Part #SDK076
OEM Part #100798-02

PM-2 KIT (LEYBOLD PUMP)

- Annual planned maintenance kit
- Includes all parts as shown and listed in the chart below
- Also available: PM-1 Kit (Leybold Pump) (RPI Part #SDK075) - for biannual planned maintenance (see page 524)

Model: NX

**Includes the
Catalytic Converter!**

Also sold separately,
just ask for
RPI Part #SDC005

INCLUDES

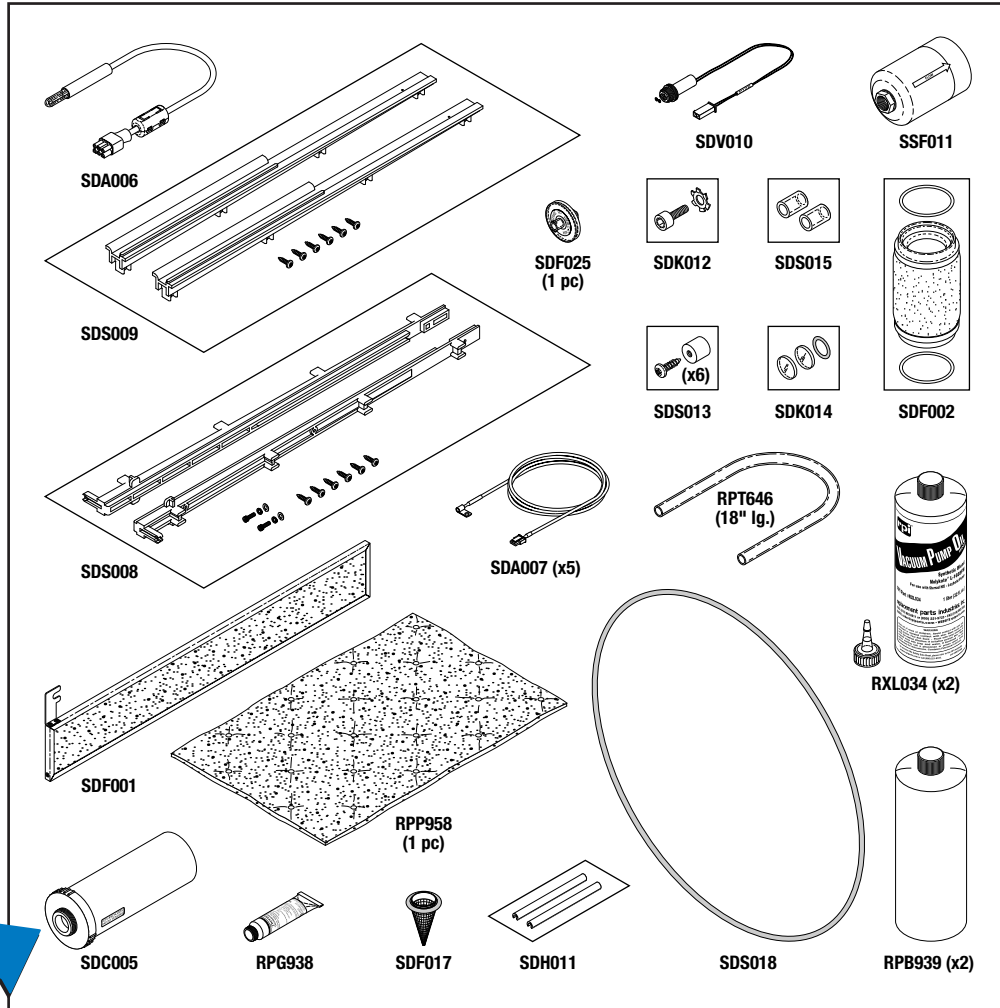

RPI PART #	OEM PART #	DESCRIPTION	KIT QTY	REORDER PKG QTY
SDA006	40-52125-001	UV Lamp Assembly	1	1
SDA007	40-52136-001	Thermistor Assembly	5	1
SDC005	25-05611-0-001	Catalytic Converter	1	1
SDF001	25-52153-001	Air Filter (Base)	1	1
SDF002	25-08560-001	Oil Mist Filter (Red)	1	1
SDF017	100147-01	Conical Screen Filter	1	1
SDF025	25-50703-001	Air Filter (25mm)	1 pc	3
SDH011	33-05440-0-002	Handle (Shelf Extension)	1 Pkg of 2	1 Pkg of 2
SDK012	109522-01	Feedthru Screw Washer Kit	1	1
SDK014	32-51413-0-001/22-00537-209	Optical Window Kit	1	1
SDS008	33-53558-0-001	Shelf Support (Upper)	1 Pkg of 2	1 Pkg of 2
SDS009	33-51152-0-001	Shelf Support (Lower)	1 Pkg of 2	1 Pkg of 2
SDS013	33-51158-0-001	Spacer (Electrode)	1 Pkg of 6	1 Pkg of 6
SDS015	No OEM Part # Available	Sleeve Gasket	1 Pkg of 2	1 Pkg of 2
SDS018	22-00537-385	Chamber/Door Seal	1	1
SDV010	28-53786-001	Delivery Valve	1	1
SSF011	25-51198-001	Sterile Air (HEPA) Filter	1	1
RPB939	No OEM Part # Available	Bottle (1 liter/32 fl. oz.)	2	1
RPG938	No OEM Part # Available	Thermal Grease (Thermalcote™)	1	1
RPP958	No OEM Part # Available	Absorbent Pad	1 pc	3
RPT646	No OEM Part # Available	Tubing (3/8" ID x 1/2" OD Clear)	18"	Per Foot
RXL034	No OEM Part # Available	Vacuum Pump Oil (Leybold Pump)	2	1

ANNUAL PM KIT



RPI Part #SDK059
OEM Part #
05-53441-1-002A

PM-2 KIT

- Annual planned maintenance kit
- Includes all parts as shown and listed in the chart below
- Also available: PM-1 Kit (RPI Part #SDK058) - for biannual planned maintenance (see page 525)

Model: 100NX

Includes the Catalytic Converter!
Also sold separately,
just ask for
RPI Part #SDC005

INCLUDES

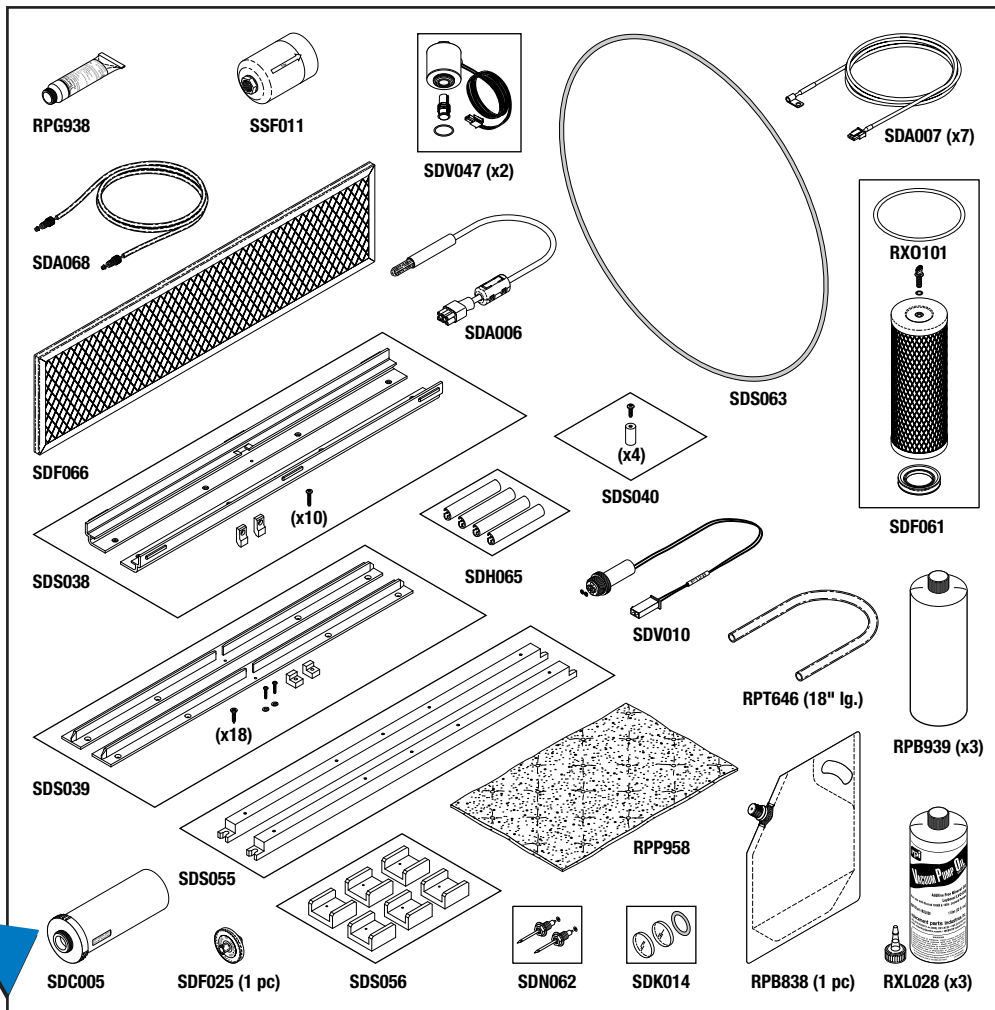

RPI PART #	OEM PART #	DESCRIPTION	KIT QTY	REORDER PKG QTY
SDA006	40-52125-001	UV Lamp Assembly	1	1
SDA007	40-52136-001	Thermistor Assembly	7	1
SDA068	27-53299-001	Tubing Assembly (H ₂ O ₂ Delivery)	1	1
SDC005	25-05611-0-001	Catalytic Converter	1	1
SDF025	25-50703-001	Air Filter (25mm)	1 pc	3
SDF061	25-54623-001	Oil Mist Filter Kit	1	1
SDF066	25-52474-001	Air Filter (Rear Panel)	1	1
SDH065	33-53096-0-001	Shelf Handle (Extrusion)	1 Pkg of 4	1 Pkg of 4
SDK014	32-51413-0-001/22-00537-209	Optical Window Kit	1	1
SDN062	06-52675-0-001/22-00537-001 ¹	Needle H ₂ O ₂ Transfer	1 Pkg of 2	1 Pkg of 2
SDS038	33-52419-0-001/33-52669-0-001 ²	Shelf Support (Lower)	1 Pkg of 2	1 Pkg of 2
SDS039	33-52418-0-001/33-52670-0-001 ³	Shelf Support (Upper)	1 Pkg of 2	1 Pkg of 2
SDS040	33-52586-0-001	Electrode Spacer (Top)	1 Pkg of 4	1 Pkg of 4
SDS055	33-52668-0-001	Electrode Spacer (Bottom)	1 Pkg of 2	1 Pkg of 2
SDS056	33-54618-0-001	Electrode Spacer (Side)	1 Pkg of 6	1 Pkg of 6
SDS063	22-00537-388	Chamber/Door Seal	1	1
SDV010	28-53786-001	Delivery Valve	1	1
SDV047	28-51428-002	Inlet Valve	2	1
SSF011	25-51198-001	Sterile Air (HEPA) Filter	1	1
RPB838	No OEM Part # Available	Disposal Bag	1 pc	3
RPB939	No OEM Part # Available	Bottle (1 liter/32 fl. oz.)	3	1
RPG938	No OEM Part # Available	Thermal Grease (Thermalcote™)	1	1
RPP958	No OEM Part # Available	Absorbent Pad	1 Pkg of 3	1 Pkg of 3
RPT646	No OEM Part # Available	Tubing (3/8" ID x 1/2" OD Clear)	18"	Per Foot
RXL028	37-00759-003	Vacuum Pump Oil (100NX & 100S - Leybold Pump)	3	1

Footnotes: ¹ 06-52675-0-001 (Needle only)/ 22-00537-001 (O-ring only) ² 33-52419-0-001/ 33-52669-0-001 (Shelf Stop, Lower only) ³ 33-52418-0-001 (Shelf Support only)/ 33-52670-0-001 (Shelf Stop only)

Call Us Toll-Free Monday-Friday, 8:00 AM-4:30 PM (Pacific Time), (800) 221-9723

Sterilization Systems

Models: NX, 100NX & 100S (continued)

ANNUAL PM KIT



RPI Part #SDK060
OEM Part #
05-06899-2-200

PM-2 KIT

- Annual planned maintenance kit
- Includes all parts as shown and listed in the chart below
- Also available: PM-1 Kit (RPI Part #SDK020) - for biannual planned maintenance (see page 525)

Model: 100S

Includes the Catalytic Converter!
Also sold separately,
just ask for
RPI Part #SDC005

INCLUDES

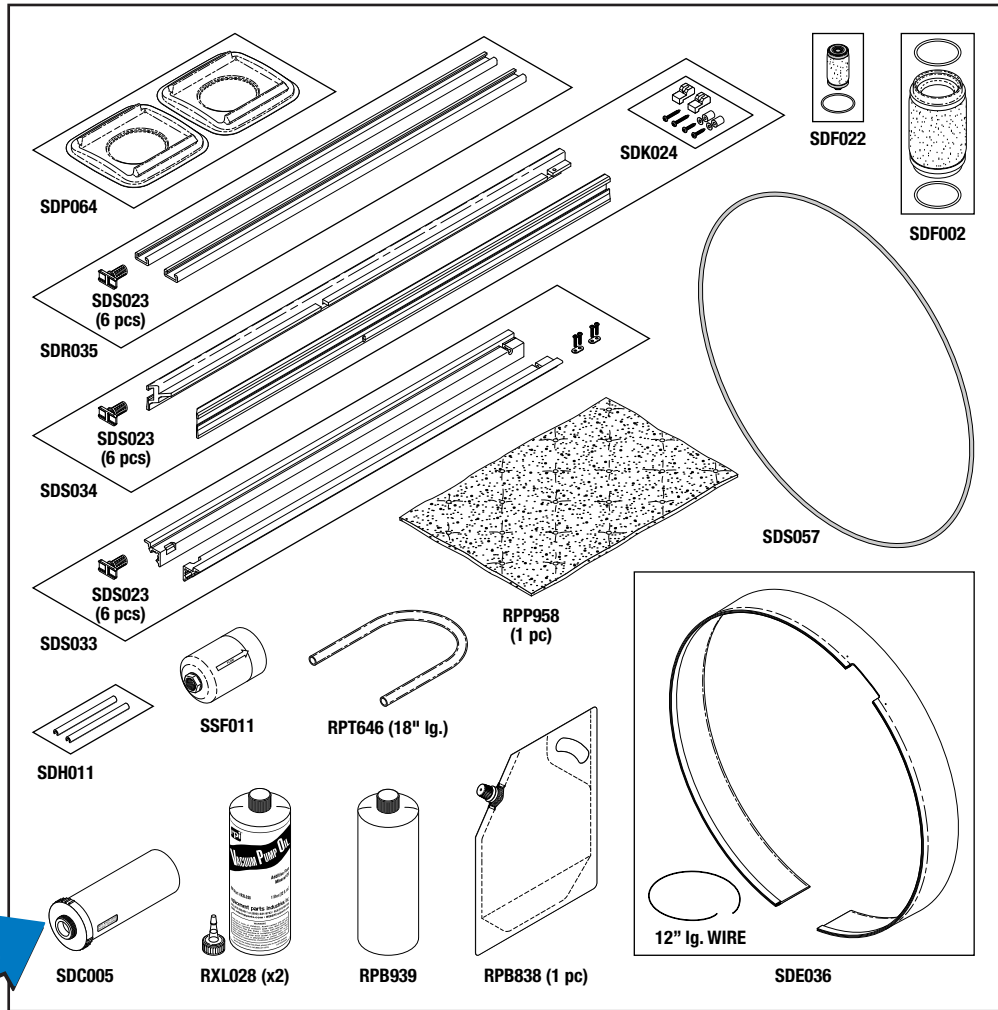

RPI PART #	OEM PART #	DESCRIPTION	KIT QTY	REORDER PKG QTY
SDC005	25-05611-0-001	Catalytic Converter	1	1
SDE036	33-02343-0-001	Extender (Electrode)	1	1
SDF002	25-08560-001	Oil Mist Filter (Red)	1	1
SDF022	25-04351-001	Mist Filter	1	1
SDH011	33-05440-0-002	Handle (Shelf Extension)	1 Pkg of 2	1 Pkg of 2
SDP064	03-53046-1-001	Vaporizer Plate	1 Pkg of 2	1 Pkg of 2
SDR035	No OEM Part # Available	Guide Rails	1 Pkg of 2	1 Pkg of 2
SDS033	30-01997-0-001	Shelf Support (Lower)	1 Pkg of 2	1 Pkg of 2
SDS034	33-01998-0-001 (Shelf support, left) 33-01999-0-002 (Shelf support, right) 33-02069-0-001 (Stop)	Shelf Support (Upper)	1 Pkg of 2	1 Pkg of 2
SDS057	22-00537-388	Chamber/Door Seal	1	1
SSF011	25-51198-001	Sterile Air (HEPA) Filter	1	1
RPB838	No OEM Part # Available	Disposal Bag	1 pc	3
RPB939	No OEM Part # Available	Bottle (1 liter/32 fl. oz.)	1	1
RPP958	No OEM Part # Available	Absorbent Pad	1 pc	3
RPT646	No OEM Part # Available	Tubing (3/8" ID x 1/2" OD Clear)	18"	Per Foot
RXL028	37-00759-003	Vacuum Pump Oil (100NX & 100S - Leybold Pump)	2	1

BIANNUAL PM KIT to fit ADIXEN/ PFEIFFER PUMP



RPI Part #SDK004
OEM Part #100797-02

PM-1 KIT (ADIXEN/PFEIFFER PUMP)

- Biannual planned maintenance kit
- Includes all parts as shown and listed in the chart below
- Also available: PM-2 Kit (Adixen/Pfeiffer Pump) (RPI Part #SDK003) - for annual planned maintenance (see page 520)

Model: NX

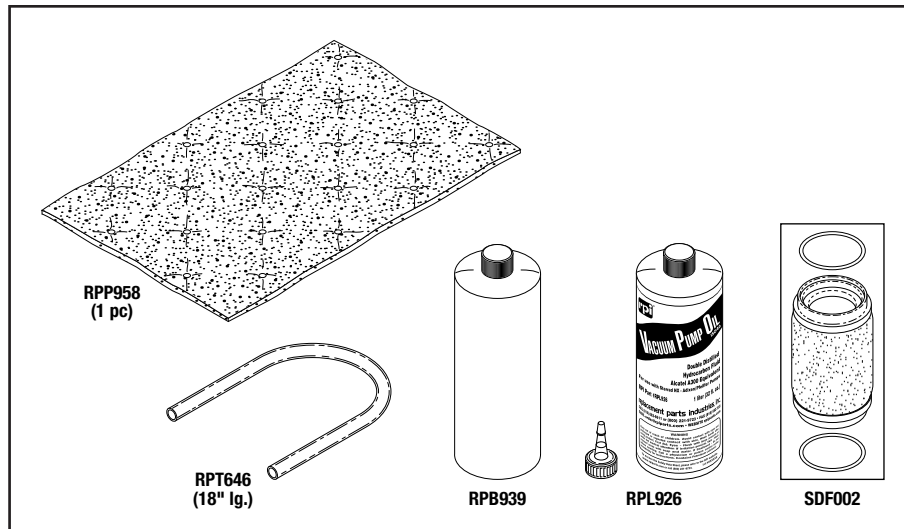

RPI PART #	OEM PART #	DESCRIPTION	KIT QTY	REORDER PKG QTY
SDF002	25-08560-001	Oil Mist Filter (Red)	1	1
RPB939	No OEM Part # Available	Bottle (1 liter/32 fl. oz.)	1	1
RPL926	37-00579-003	Vacuum Pump Oil (Adixen/Pfeiffer Pump)	1	1
RPP958	No OEM Part # Available	Absorbent Pad	1 pc	3
RPT646	No OEM Part # Available	Tubing (3/8" ID x 1/2" OD Clear)	18"	Per Foot

BIANNUAL PM KIT to fit LEYBOLD PUMP



RPI Part #SDK075
OEM Part #100797-02

PM-1 KIT (LEYBOLD PUMP)

- Biannual planned maintenance kit
- Includes all parts as shown and listed in the chart below
- Also available: PM-2 Kit (Leybold Pump) (RPI Part #SDK076) - for annual planned maintenance (see page 521)

Model: NX

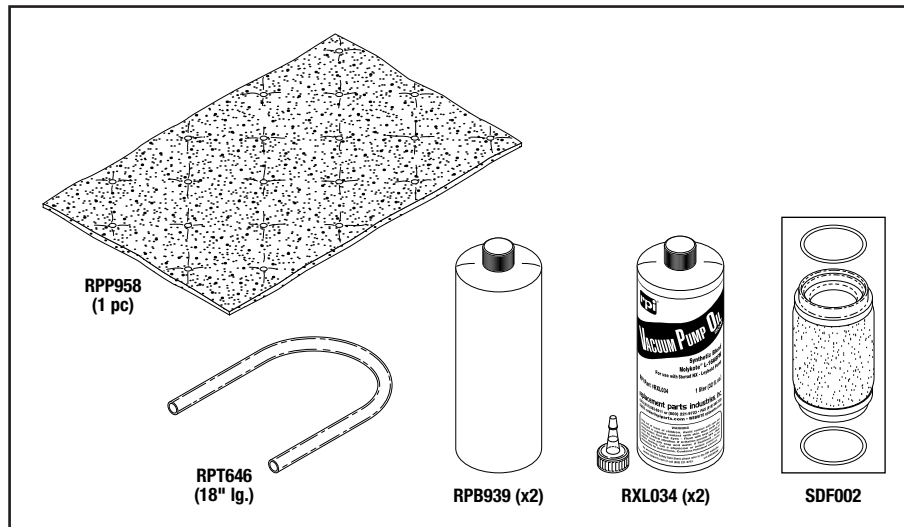

RPI PART #	OEM PART #	DESCRIPTION	KIT QTY	REORDER PKG QTY
SDF002	25-08560-001	Oil Mist Filter (Red)	1	1
RPB939	No OEM Part # Available	Bottle (1 liter/32 fl. oz.)	2	1
RPP958	No OEM Part # Available	Absorbent Pad	1 pc	3
RPT646	No OEM Part # Available	Tubing (3/8" ID x 1/2" OD Clear)	18"	Per Foot
RXL034	No OEM Part # Available	Vacuum Pump Oil (Leybold Pump)	2	1

Sterilization Systems

Models: NX, 100NX & 100S (continued)

BIANNUAL PM KIT



RPI Part #SDK058
OEM Part #05-53441-1-001A

PM-1 KIT

- Biannual planned maintenance kit
- Includes all parts as shown and listed in the chart below
- Also available: PM-2 Kit (RPI Part #SDK059) - for annual planned maintenance (see page 522)

Model: 100NX

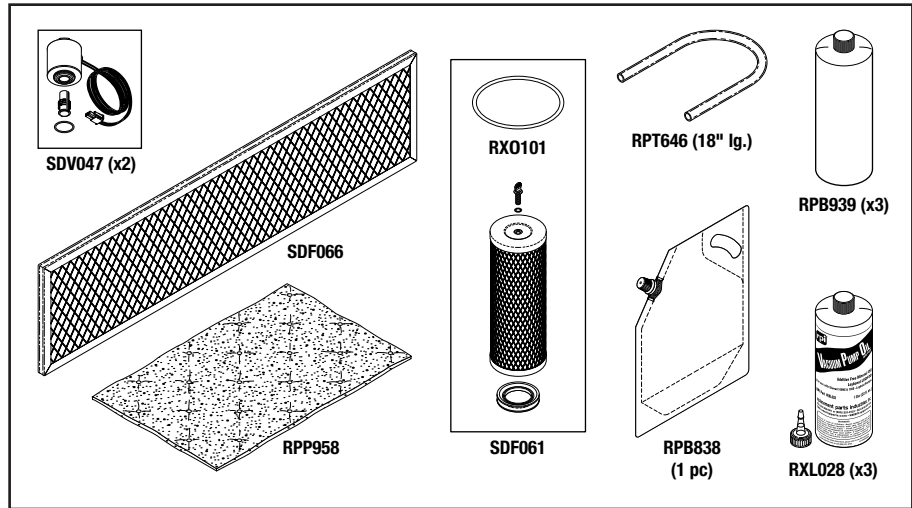

RPI PART #	OEM PART #	DESCRIPTION	KIT QTY	REORDER PKG QTY
SDF061	25-54623-001	Oil Mist Filter Kit	1	1
SDF066	25-52474-001	Air Filter (Rear Panel)	1	1
SDV047	28-51428-002	Inlet Valve	2	1
RPB838	No OEM Part # Available	Disposal Bag	1 pc	3
RPB939	No OEM Part # Available	Bottle (1 liter/32 fl. oz.)	3	1
RPP958	No OEM Part # Available	Absorbent Pad	1 Pkg of 3	1 Pkg of 3
RPT646	No OEM Part # Available	Tubing (3/8" ID x 1/2" OD Clear)	18"	Per Foot
RXL028	37-00759-003	Vacuum Pump Oil (100NX & 100S - Leybold Pump)	3	1

BIANNUAL PM KIT

RPI Part #SDK020
OEM Part #05-06899-1-100

PM-1 KIT

- Biannual planned maintenance kit
- Includes all parts as shown and listed in the chart below
- Also available: PM-2 Kit (RPI Part #SDK060) - for annual planned maintenance (see page 523)

Model: 100S

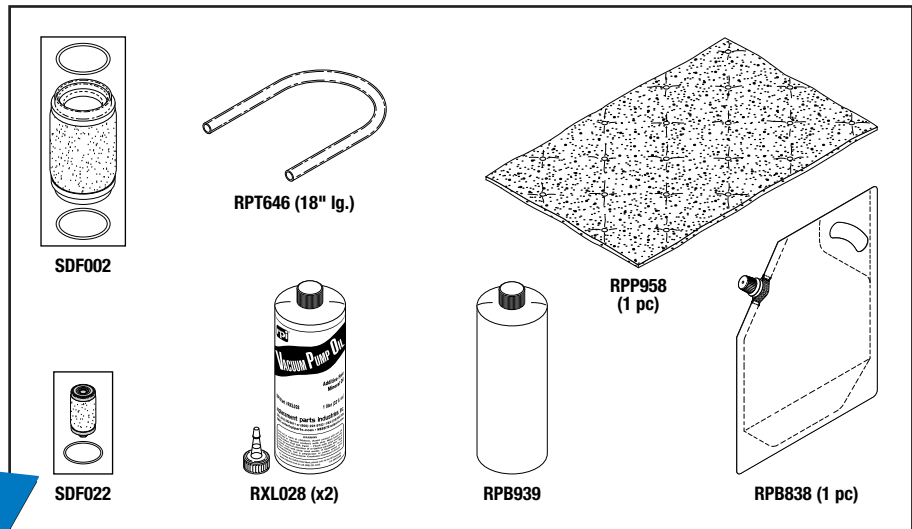

Now Includes: Mist Filter (RPI Part #SDF022) and 2 bottles of Vacuum Pump Oil (RPI Part #RXL028)

INCLUDES

RPI PART #	OEM PART #	DESCRIPTION	KIT QTY	REORDER PKG QTY
SDF002	25-08560-001	Oil Mist Filter (Red)	1	1
SDF022	25-04351-001	Mist Filter	1	1
RPB838	No OEM Part # Available	Disposal Bag	1 pc	3
RPB939	No OEM Part # Available	Bottle (1 liter/32 fl. oz.)	1	1
RPP958	No OEM Part # Available	Absorbent Pad	1 pc	3
RPT646	No OEM Part # Available	Tubing (3/8" ID x 1/2" OD Clear)	18"	Per Foot
RXL028	37-00759-003	Vacuum Pump Oil (100NX & 100S - Leybold Pump)	2	1

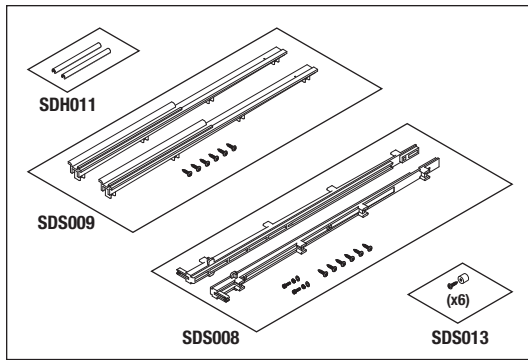

RPI Part #SDK016
OEM Part # (No OEM Part # Available)

CHAMBER PLASTICS KIT

- Includes all parts as shown
- Included in: PM-2 Kit (Adixen/Pfeiffer Pump) (RPI Part #SDK003) and PM-2 Kit (Leybold Pump) (RPI Part #SDK076)

Fits: Electrode Assembly
Model: NX

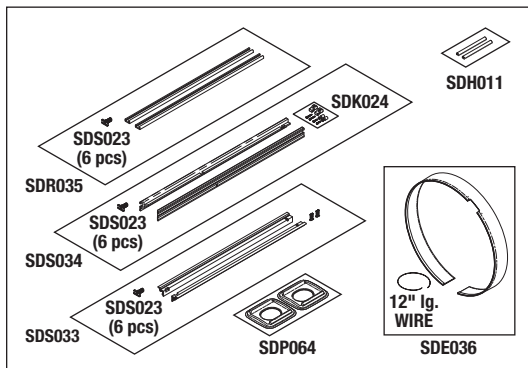

RPI Part #SDK032
OEM Part # (No OEM Part # Available)

CHAMBER PLASTICS KIT

- Includes all parts as shown
- Included in: PM-2 Kit (RPI Part #SDK060)

Model: 100S

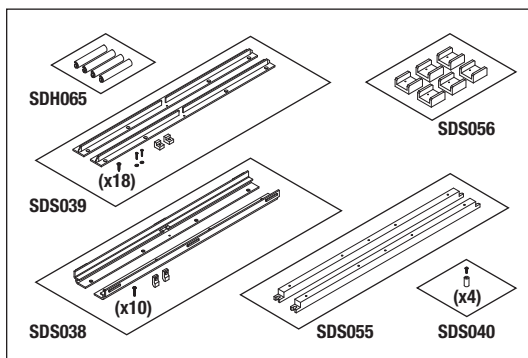

RPI Part #SDK037
OEM Part # (No OEM Part # Available)

CHAMBER PLASTICS KIT

- Includes all parts as shown
- Included in: PM-2 Kit (RPI Part #SDK059)
- Also available: Shoulder Screw (M6 x 10mm Ig.) (RPI Part #RXH026)

Fits: Electrode Assembly
Model: 100NX

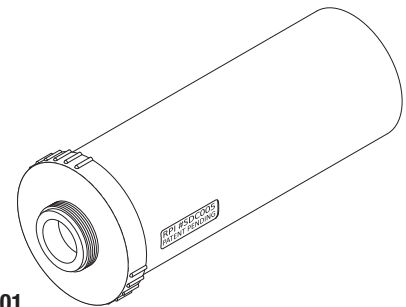

RPI Part #SDC005
OEM Part #25-05611-0-001

CATALYTIC CONVERTER

- Included in: PM-2 Kit (Adixen/Pfeiffer Pump) (RPI Part #SDK003), PM-2 Kit (RPI Part #SDK059), PM-2 Kit (RPI Part #SDK060), and PM-2 Kit (Leybold Pump) (RPI Part #SDK076)

Fits: Vacuum Pump Assembly
Models: NX, 100NX & 100S

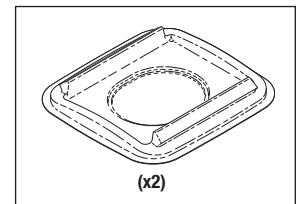

RPI Part #SDP064
OEM Part #03-53046-1-001

VAPORIZER PLATE

- 2 per package
- It is recommended that the Vaporizer Plate be replaced every 30 days or 145 cycles, whichever comes first.
- Included in: Chamber Plastics Kit (RPI Part #SDK032) and PM-2 Kit (RPI Part #SDK060)

Fits: Electrode Assembly
Model: 100S

Also available in packages of 12!

RPI Part #SDK067
OEM Part # (No OEM Part # Available)

VAPORIZER PLATE (12 PACK)

- 12 per package
- Includes: 6 packages of 2 each Vaporizer Plate (RPI Part #SDP064)

Fits: Electrode Assembly
Model: 100S

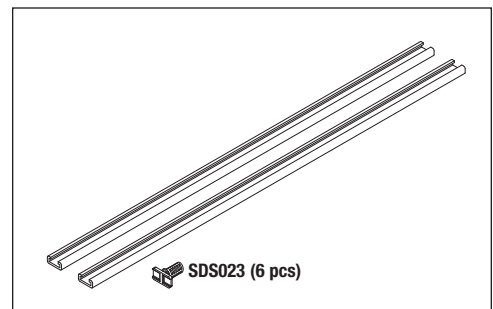

RPI Part #SDR035
OEM Part # (No OEM Part # Available)

GUIDE RAILS

- 2 per package
- Includes: (6 pc) Electrode Spacer (RPI Part #SDS023)
- Included in: Chamber Plastics Kit (RPI Part #SDK032) and PM-2 Kit (RPI Part #SDK060)

Fits: Electrode Assembly
Model: 100S

Sterilization Systems

Models: NX, 100NX & 100S (continued)

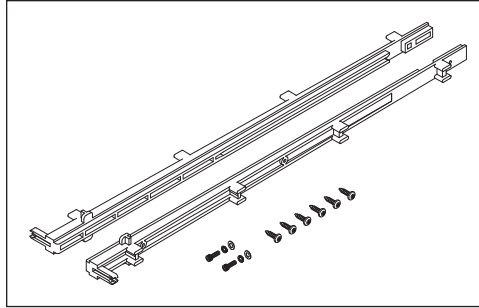

RPI Part #SDS008
OEM Part #33-53558-0-001

SHELF SUPPORT (UPPER)

- 2 per package
- Includes: Mounting hardware
- Included in: PM-2 Kit (Adixen/Pfeiffer Pump) (RPI Part #SDK003), PM-2 Kit (Leybold Pump) (RPI Part #SDK076), and Chamber Plastics Kit (RPI Part #SDK016)

Fits: Chamber Module
Model: NX

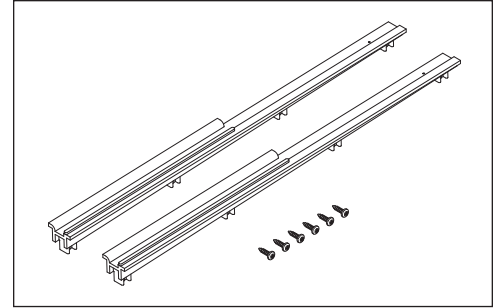

RPI Part #SDS009
OEM Part #33-51152-0-001

SHELF SUPPORT (LOWER)

- 2 per package
- Includes: Mounting hardware
- Included in: PM-2 Kit (Adixen/Pfeiffer Pump) (RPI Part #SDK003), PM-2 Kit (Leybold Pump) (RPI Part #SDK076), and Chamber Plastics Kit (RPI Part #SDK016)

Fits: Chamber Module
Model: NX

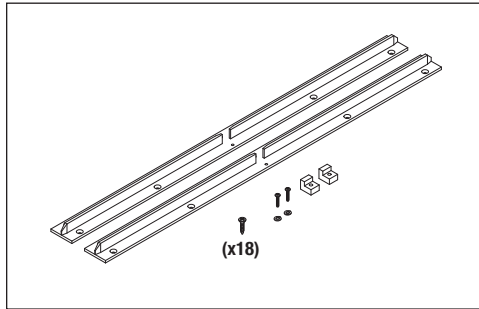

RPI Part #SDS039
OEM Part #33-52418-0-001 (Shelf Support), 33-52670-0-001 (Shelf Stop)

SHELF SUPPORT (UPPER)

- Includes all parts as shown
- Included in: Chamber Plastics Kit (RPI Part #SDK037) and PM-2 Kit (RPI Part #SDK059)

Fits: Electrode Assembly
Model: 100NX

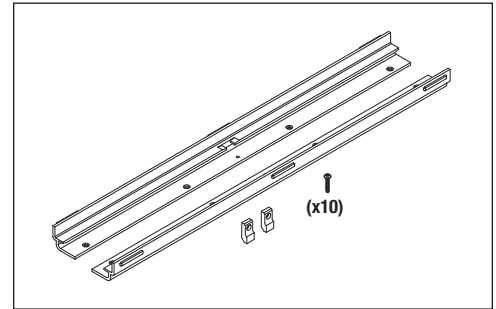

RPI Part #SDS038
OEM Part #33-52419-0-001, 33-52669-0-001 (Shelf Stop, lower)

SHELF SUPPORT (LOWER)

- Includes all parts as shown
- Included in: Chamber Plastics Kit (RPI Part #SDK037) and PM-2 Kit (RPI Part #SDK059)

Fits: Electrode Assembly
Model: 100NX

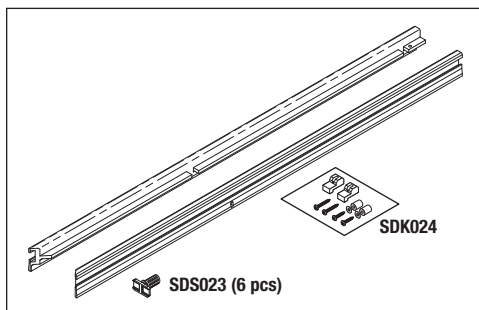

RPI Part #SDS034
OEM Part #33-01998-0-001 (Shelf support, left), 33-01999-0-002 (Shelf support, right) and 33-02069-0-001 (Stop)

SHELF SUPPORT (UPPER)

- Includes all parts as shown
- Included in: Chamber Plastics Kit (RPI Part #SDK032) and PM-2 Kit (RPI Part #SDK060)

Fits: Electrode Assembly
Model: 100S

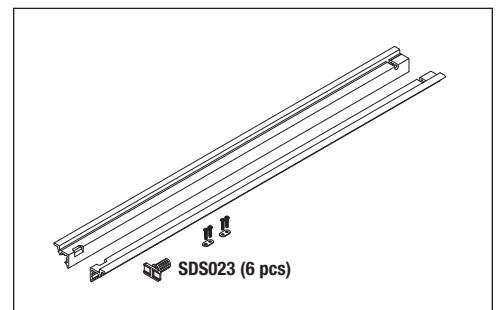

RPI Part #SDS033
OEM Part #30-01997-0-001

SHELF SUPPORT (LOWER)

- Includes all parts as shown
- Included in: Chamber Plastics Kit (RPI Part #SDK032) and PM-2 Kit (RPI Part #SDK060)

Fits: Electrode Assembly
Model: 100S

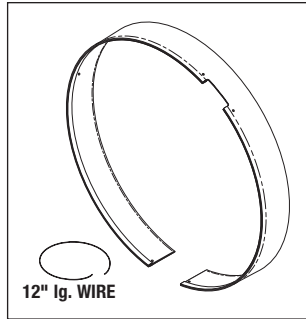

12" lg. WIRE



SDE036
CROSS SECTION
SHOWN ACTUAL SIZE

RPI Part #SDE036
OEM Part #33-02343-0-001

EXTENDER (ELECTRODE)

- Includes: Attaching wire, 316L (soft) stainless steel 12" lg.
- Included in: Chamber Plastics Kit (RPI Part #SDK032) and PM-2 Kit (RPI Part #SDK060)

Fits: Electrode Assembly
Model: 100S

RPI Part #SDH065
OEM Part #33-53096-0-001

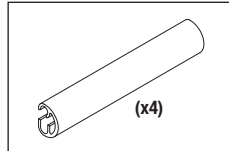

(x4)

SHELF HANDLE (EXTRUSION)

- 4 per package
- Size: 4.17" lg. x .78" wide
- Included in: PM-2 Kit (RPI Part #SDK059) and Chamber Plastics Kit (RPI Part #SDK037)

Fits: Shelf (Top and Bottom)
Model: 100NX

RPI Part #SDH011
OEM Part #33-05440-0-002

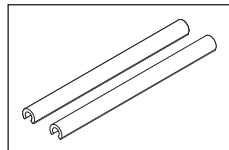

HANDLE (SHELF EXTENSION)

- 2 per package
- Size: 5/16" dia. x 4-1/8" lg.
- Included in: PM-2 Kit (Adixen/Pfeiffer Pump) (RPI Part #SDK003), PM-2 Kit (Leybold Pump) (RPI Part #SDK076), PM-2 Kit (RPI Part #SDK060), Chamber Plastics Kit (RPI Part #SDK016), and Chamber Plastics Kit (RPI Part #SDK032)

Fits: Shelf Extension
Model: NX

RPI Part #SDK024
OEM Part #33-02069-0-001

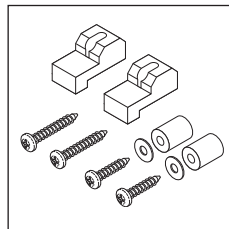

SHELF STOP KIT

- 2 per package
- Includes: Mounting hardware
- Included in: Shelf Support (Upper) (RPI Part #SDS034)

Fits: Chamber
Model: 100S

RPI Part #SDS040
OEM Part #33-52586-0-001

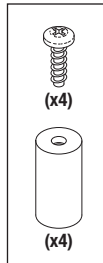

(x4)

(x4)

ELECTRODE SPACER (TOP)

- 4 per package
- Includes: Mounting hardware
- Size: 1/2" dia. x 1.00" lg.
- Included in: Chamber Plastics Kit (RPI Part #SDK037) and PM-2 Kit (RPI Part #SDK059)

Fits: Electrode Assembly
Model: 100NX

RPI Part #SDS023
OEM Part #33-00888-0-001

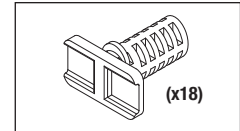

(x18)

ELECTRODE SPACER

- 18 per package
- Included in: Guide rails (RPI Part #SDR035), Shelf Support (Upper) (RPI Part #SDS034) and Shelf Support (Lower) (RPI Part #SDS034)

Fits: Chamber Assembly
Model: 100S

RPI Part #SDS013
OEM Part #33-51158-0-001

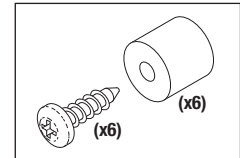

(x6)

SPACER (ELECTRODE)

- 6 per package
- Includes: Mounting screws
- Included in: PM-2 Kit (Adixen/Pfeiffer Pump) (RPI Part #SDK003), PM-2 Kit (Leybold Pump) (RPI Part #SDK076), and Chamber Plastics Kit (RPI Part #SDK016)

Fits: Electrode Assembly
Model: NX

RPI Part #SDS056
OEM Part #33-54618-0-001

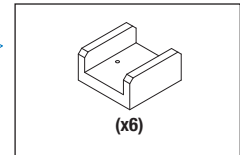

(x6)

SPACER ELECTRODE (SIDE)

- 6 per package
- Included in: Chamber Plastics Kit (RPI Part #SDK037) and PM-2 Kit (RPI Part #SDK059)

Fits: Electrode Assembly
Model: 100NX

RPI Part #SDS055
OEM Part #33-52668-0-001

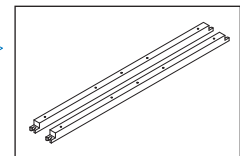

SPACER ELECTRODE (BOTTOM)

- 2 per package
- Included in: Chamber Plastics Kit (RPI Part #SDK037) and PM-2 Kit (RPI Part #SDK059)
- Also available: Shoulder Screw (M6 x 10mm lg.) (RPI Part #RXH026)

Fits: Electrode Assembly
Model: 100NX

RPI Part #RXH026
OEM Part # (No OEM Part # Available)

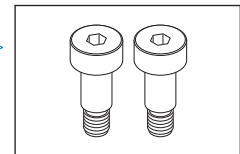

SHOULDER SCREW

- 2 per package
- Size: M6 x 10mm lg.; M5 thread
- Material: Stainless steel

Fits: Electrode Spacer (Bottom)
Model: 100NX

RPI Part #SDS015
OEM Part # (No OEM Part # Available)

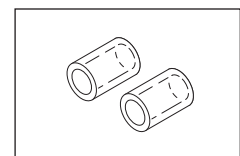

SLEEVE GASKET

- 2 per package
- Material: Silicone
- Size: .125" ID x .188" OD x .275" lg.
- Included in: PM-2 Kit (Adixen/Pfeiffer Pump) (RPI Part #SDK003) and PM-2 Kit (Leybold Pump) (RPI Part #SDK076)

Fits: Air Pump
Model: NX

Sterilization Systems

Models: NX, 100NX & 100S (continued)

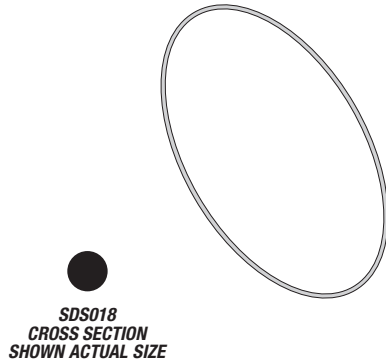

RPI Part #SDS018
OEM Part #22-00537-385

DOOR SEAL

- Size: 15.95" ID x 16.37" OD x .21" C/S
- Material: Viton® (FKM), 75 Duro
- Included in: PM-2 Kit (Adixen/Pfeiffer Pump) (RPI Part #SDK003) and PM-2 Kit (Leybold Pump) (RPI Part #SDK076)

Fits: Chamber Assembly
Model: NX

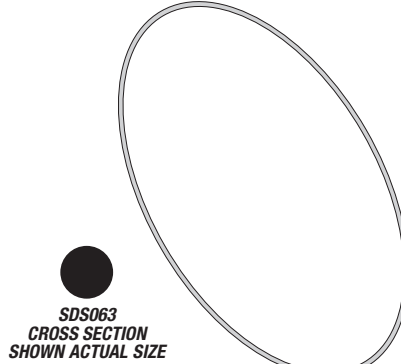

RPI Part #SDS063
OEM Part #22-00537-388

CHAMBER/DOOR SEAL

- Size: 22.505" OD x 21.955" ID x .275" C/S
- Material: Viton® (FKM), 75 Duro
- Included in: PM-2 Kit (RPI Part #SDK059)

Fits: Chamber Assembly
Model: 100NX

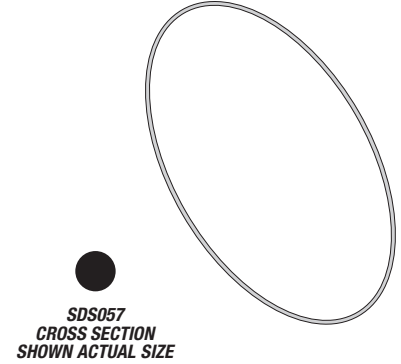

RPI Part #SDS057
OEM Part #22-00537-388

CHAMBER/DOOR SEAL

- Size: 18.955" ID x 19.373" OD x .210" C/S
- Material: Viton® (FKM), 75 Duro
- Included In: PM-2 Kit (RPI Part #SDK060)

Fits: Chamber Assembly
Model: 100S

RPI Part #SDA006
OEM Part #40-52125-001

UV LAMP ASSEMBLY

- Rated at 900 VRMS
- 12" lg. cable with connector
- Includes: Ferrite suppression core
- Included in: PM-2 Kit (Adixen/Pfeiffer Pump) (RPI Part #SDK003), PM-2 Kit (RPI Part #SDK059), and PM-2 Kit (Leybold Pump) (RPI Part #SDK076)

Fits: Hydrogen Peroxide Monitor and Detector
Model: NX

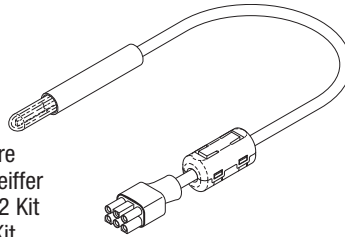

RPI Part #SDK012
OEM Part #109522-01

FEEDTHRU SCREW WASHER KIT

- Includes: Screw (M3 x 8 S/S Socket Head Cap Screw) and External Tooth Lock Washer (M3 S/S)
- Included in: PM-2 Kit (Adixen/Pfeiffer Pump) (RPI Part #SDK003) and PM-2 Kit (Leybold Pump) (RPI Part #SDK076)

Fits: Electrode Assembly
Model: NX

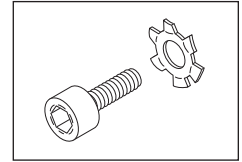

RPI Part #SDA007
OEM Part #40-52136-001

THERMISTOR ASSEMBLY

- Rated: 10K @ 25°C
- Cable length: 50" lg.
- Included in: PM-2 Kit (Adixen/Pfeiffer Pump) (RPI Part #SDK003), PM-2 Kit (RPI Part #SDK059), and PM-2 Kit (Leybold Pump) (RPI Part #SDK076)
- Also available: Thermal Grease (ThermalCote™) (RPI Part #RPG938)

Fits: Door and Chassis
Model: NX

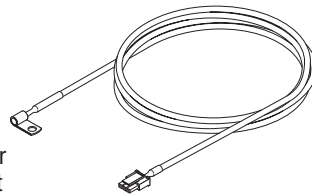

RPI Part #SDN062
OEM Part #06-52675-0-001
(Needle); 22-00537-001 (O-ring)

NEEDLE H2O2 TRANSFER

- 2 per package
- Includes: (2) O-rings
- Included in: PM-2 Kit (RPI Part #SDK059)

Fits: H2O2 Delivery Assembly
Models: NX & 100NX

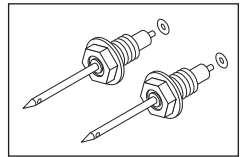

RPI Part #SDK014
OEM Part #32-51413-0-001/22-00537-209

OPTICAL WINDOW KIT

- Includes: (2) Optical windows and (1) Viton® (FKM) O-ring
- Included in: PM-2 Kit (Adixen/Pfeiffer Pump) (RPI Part #SDK003), PM-2 Kit (RPI Part #SDK059), and PM-2 Kit (Leybold Pump) (RPI Part #SDK076)

Fits: Hydrogen Peroxide Monitor and Detector
Model: NX

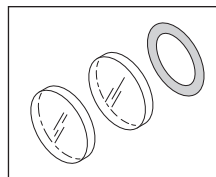

NEW PART

RPI Part #SDA068
OEM Part #27-53299-001,
27-53249-001

TUBING ASSEMBLY (H2O2 DELIVERY)

- Size: 39" lg.
- Includes: (2) O-rings
- Included in: PM-2 Kit (RPI Part #SDK059)

Fits: H2O2 Delivery Assembly
Model: 100NX

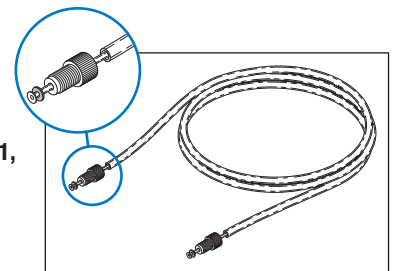

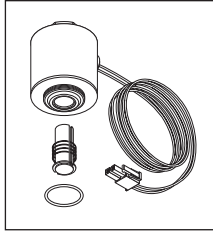

RPI Part #SDV047
OEM Part #28-51428-002

INLET VALVE

- Manifold mount
- 24VDC, 10W (59-61 Ω); 22" lg. wire with Molex connector
- Includes all parts as shown
- Included in: PM-1 Kit (RPI Part #SDK058) and PM-2 Kit (RPI Part #SDK059)
- Also available: Spanner Nut (RPI Part #ILS014) and Double Ended Spanner Wrench (RPI Part #RPT501)

Fits: Vaporizer/Condenser Assembly
Models: NX & 100NX

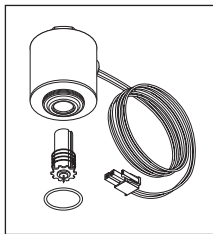

RPI Part #SDV046
OEM Part #40-54257-001

TRANSITION VALVE

- Manifold mount
- 24VDC, 10W (40-42 Ω); 22" lg. wire with Molex connector
- Includes all parts as shown
- Also available: Spanner Nut (RPI Part #ILS014) and Double Ended Spanner Wrench (RPI Part #RPT501)

Fits: Vaporizer/Condenser Assembly
Models: NX

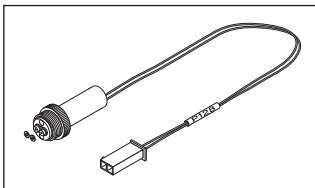

RPI Part #SDV010
OEM Part #28-53786-001

DELIVERY VALVE

- 24 VDC; 2 Way N.C.; 6 1/2" lg. wire leads with connector
- Includes: (2) Viton® (FKM) gaskets
- Included in: PM-2 Kit (Adixen/ Pfeiffer Pump) (RPI Part #SDK003), PM-2 Kit (RPI Part #SDK059), and PM-2 Kit (Leybold Pump) (RPI Part #SDK076)

Fits: Delivery System
Model: NX

RPI Part #SDF066
OEM Part #25-52474-001



AIR FILTER (REAR PANEL)

- Size: 28.0" lg. x 7.0" wide
- Material: 45 PPI Quadrafoam, aluminum frame and stainless steel mesh
- Included in: PM-1 Kit (RPI Part #SDK058) and PM-2 Kit (RPI Part #SDK059)

Fits: Base of Machine
Model: 100NX

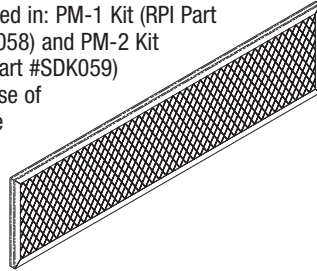

RPI Part #SDF001
OEM Part #25-52153-001

AIR FILTER (BASE)

- Size: 19.30" lg. x 2.84" wide
- Material: 45 PPI Uni-Foam, aluminum frame and stainless steel mesh
- Included in: PM-2 Kit (Adixen/Pfeiffer Pump) (RPI Part #SDK003) and PM-2 Kit (Leybold Pump) (RPI Part #SDK076)

Fits: Base Module
Model: NX

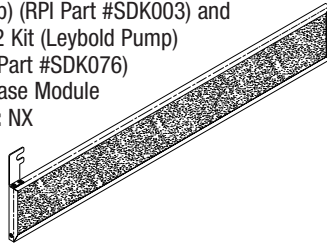

RPI Part #SDF025
OEM Part #25-50703-001

AIR FILTER

- 3 per package
- 0.2 micron, 25mm
- Ports: Luer lock
- Included in: PM-2 Kit (Adixen/Pfeiffer Pump) (RPI Part #SDK003), PM-2 Kit (RPI Part #SDK059), and PM-2 Kit (Leybold Pump) (RPI Part #SDK076)

Fits: Delivery System
Model: NX

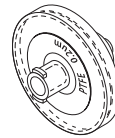

RPI Part #SSF011
OEM Part #25-51198-001

STERILE AIR (HEPA) FILTER

- 0.2 micron
- Size: 2.60" OD x 3.80" lg.; Ports: 3/8" FPT
- 75mm filter media capsule
- Included in: PM-2 Kit (Adixen/Pfeiffer Pump) (RPI Part #SDK003), PM-2 Kit (Leybold Pump) (RPI Part #SDK076), PM-2 Kit (RPI Part #SDK059) and PM-2 Kit (RPI Part #SDK060)

Fits: Air Intake Line
Model: NX

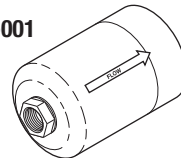

RPI Part #SDF061
OEM Part #25-54623-001



OIL MIST FILTER KIT

- Size: 3.00" dia. x 8.36" lg.
- Includes: Viton® seal, thumbscrew, and O-ring (RPI Part #RX0101)
- Included in: PM-1 Kit (RPI Part #SDK058) and PM-2 Kit (RPI Part #SDK059)

Fits: Vacuum Pump Assembly
Model: 100NX

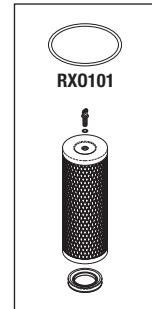

RPI Part #SDF002
OEM Part #25-08560-001

OIL MIST FILTER (RED)

- Size: 2.90" OD x 5" lg.
- Includes: (2) O-rings
- Included in: PM-1 Kit (Adixen/Pfeiffer Pump) (RPI Part #SDK004), PM-2 Kit Adixen/Pfeiffer Pump (RPI Part #SDK003), PM-1 Kit (Leybold Pump) (RPI Part #SDK075), PM-2 Kit (Leybold Pump) (RPI Part #SDK076), PM-1 Kit (RPI Part #SDK020), and PM-2 Kit (RPI Part #SDK060)

Fits: Vacuum Pump Assembly
Models: NX & 100S

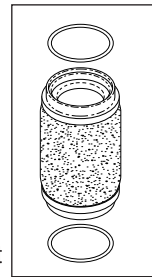

RPI Part #SDF022
OEM Part #25-04351-001

OIL MIST FILTER

- 0.3 micron
- Size: .82" OD x 1.54" lg.
- Material: Non-woven fabric
- Includes: Bowl O-ring
- Included in: PM-1 Kit (RPI Part #SDK020) and PM-2 Kit (RPI Part #SDK060)

Fits: Mist Trap
Model: 100S

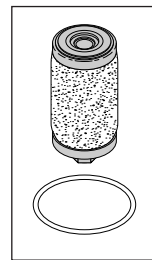

RPI Part #SDF017
OEM Part #100147-001

CONICAL SCREEN FILTER

- Material: 80 Mesh stainless steel screen with Viton® (FKM) O-ring.
- Included in: PM-2 Kit (Adixen/Pfeiffer Pump) (RPI Part #SDK003) and PM-2 Kit (Leybold Pump) (RPI Part #SDK076)

Fits: Vacuum Pump Assembly
Model: NX

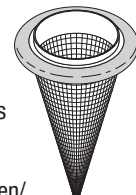

Sterilization Systems

Models: NX, 100NX & 100S (continued)

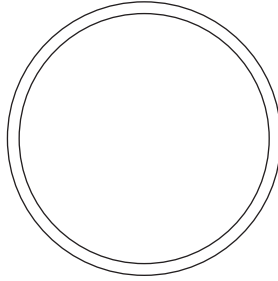
NOT SHOWN
ACTUAL SIZE

RPI Part #RX0101
OEM Part # (No OEM Part # Available)

O-RING

- Size: 4.475" ID x 4.895" OD x .210" C/S
- Material: Nitrile (Buna-N); 70 Duro
- Included in: Oil Mist Filter Kit (RPI Part #SDF061)

Fits: Filter Housing
Models: 100NX

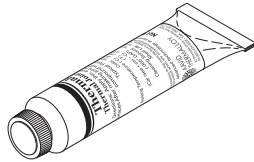

RPI Part #RPG938
OEM Part # (No OEM Part # Available)

THERMAL GREASE (THERMALCOTE™)

- Size: 1 oz. re-sealable tube
- Silicone based thermal grease
- Included in: PM-2 Kit (Adixen/Pfeiffer Pump) (RPI Part #SDK003), PM-2 Kit (Adixen/Pfeiffer Pump) (RPI Part #SDK059), and PM-2 Kit (Leybold Pump) (RPI Part #SDK076)

Used On: Thermistor Assembly
Models: NX & 100S

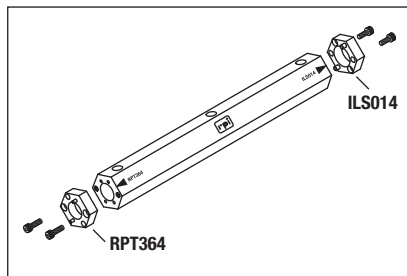

RPI Part #RPT501
OEM Part # (No OEM Part # Available)

DOUBLE ENDED SPANNER WRENCH

- Size: .875" HEX x ~7" lg.
- Material: Aluminum handle with stainless steel end attachments
- Includes Spanner Nuts (RPI Part #ILS014 and RPI Part #RPT364)
- Reversible and replaceable end attachment allow easy replacement of damaged pins..

Fits: Fill, Dump and Vent Solenoid Valve
Models: NX & 100NX



RPI Part #RPL926
OEM Part #37-00579-003

VACUUM PUMP OIL (ADIXEN/PFEIFFER PUMP)

- 1 liter (32 fl. oz.) bottle
- High grade equivalent to Alcatel 300
- Includes: Yorker spout
- Included in: PM-1 Kit (Adixen/Pfeiffer Pump) (RPI Part #SDK004) and PM-2 Kit (Adixen/Pfeiffer Pump) (RPI Part #SDK003)

Fits: Adixen/Pfeiffer Pumps
Model: NX



RPI Part #RXL034
OEM Part #

(No OEM Part # Available)

VACUUM PUMP OIL (LEYBOLD PUMP)

- 1 Liter (32 fl. oz.) bottle
- Molykote L-1668 FM oil
- Includes: Yorker spout
- Included in: PM-1 Kit (Leybold Pump) (RPI Part #SDK075) and PM-2 Kit (Leybold Pump) (RPI Part #SDK076)

Fits: Leybold Pumps
Model: NX



RPI Part #RXL028
OEM Part #37-00759-003

VACUUM PUMP OIL (100NX & 100S - LEYBOLD PUMP)

- 1 liter (32 fl. oz.) bottle
- Leybonol LVO 100 additive free mineral oil
- Includes: Yorker spout
- Included in: PM-1 Kit (RPI Part #SDK020), PM-1 Kit (RPI Part #SDK058), PM-2 Kit (RPI Part #SDK059) and PM-2 Kit (RPI Part #SDK060)

Fits: Vacuum Pump Assembly
Models: 100NX & 100S



NOTE: These parts are included in: PM-1 Kit (Adixen/Pfeiffer Pump) (RPI Part #SDK004), PM-1 Kit (RPI Part #SDK058), PM-1 Kit (Leybold Pump) (RPI Part #SDK075), PM-1 Kit (RPI Part #SDK020), PM-2 Kit (Adixen/Pfeiffer Pump) (RPI Part #SDK003), PM-2 Kit (RPI Part #SDK059), PM-2 Kit (Leybold Pump) (RPI Part #SDK076), and PM-2 Kit (RPI Part #SDK060)

RPI Part #RPB939
OEM Part # (No OEM Part # Available)

BOTTLE (1 Liter / 32 fl. oz.)

- 3-3/4" OD x 8.00" tall
- Material: HDPE plastic
- Can be used for used oil collection
- Included in: See **Note** above

Models: NX, 100NX & 100S

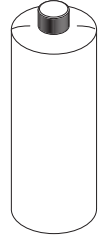

RPI Part #RPP958
OEM Part # (No OEM Part # Available)

ABSORBENT PAD

- 3 per package
- Size: 9-1/4" x 14-1/2"
- Can be used for oil drip collection and spills
- Included in: See **Note** above

Models: NX, 100NX & 100S

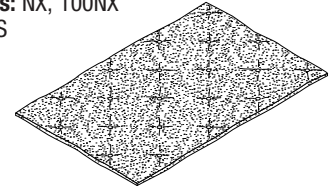

RPI Part #RPT646
OEM Part # (No OEM Part # Available)

TUBING (3/8" ID x 1/2" OD CLEAR)

- Material: Clear PVC
- Sold by the foot (reel not included)
- Included in: See **Note** above

Models: NX, 100NX & 100S

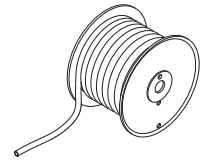

RPI Part #RPB838
OEM Part # (No OEM Part # Available)

DISPOSAL BAG

- Used oil collection and disposal bag
- 3 per package
- 1 gallon, clear plastic bag
- Included in: PM-1 Kit (RPI Part #SDK020), PM-1 Kit (RPI Part #SDK058), PM-2 Kit (RPI Part #SDK059) and PM-2 Kit (RPI Part #SDK060)

Models: NX, 100NX & 100S

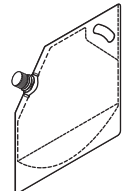

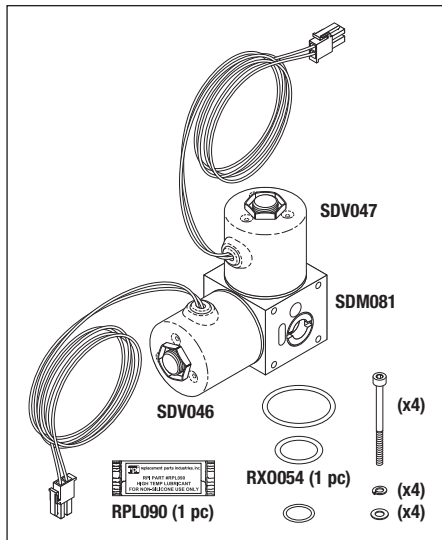

RPI Part #SDA048
OEM Part # (No OEM Part # Available)

VALVE MANIFOLD ASSEMBLY

- Includes: Transition Valve (RPI Part #SDV046), Inlet Valve (RPI Part #SDV047), Valve Manifold (RPI Part #SDM081), installed rupture disk, (1 pc) O-ring (RPI Part #RX0054), (2) O-rings, (1 pc) High Temp Lubricant (RPI Part #RPL090) and mounting hardware
- Also available: Pliers (Soft Jaw) (RPI Part #RXT005) used to grip Ultra-Torr® Fittings

Fits: Vaporizer/Condenser Assembly

Model: NX

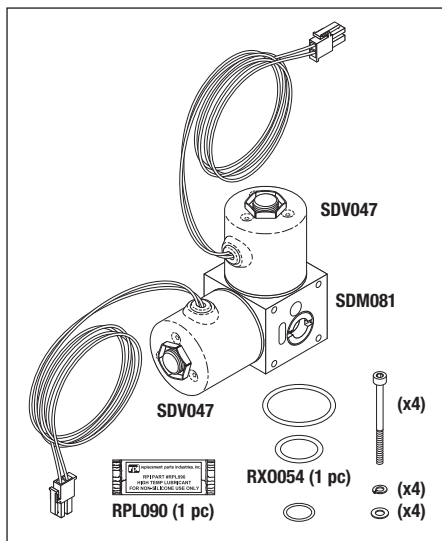

RPI Part #SDA082
OEM Part # (No OEM Part # Available)

VALVE MANIFOLD ASSEMBLY

- Includes: (2) Inlet Valve (RPI Part #SDV047), Valve Manifold (RPI Part #SDM081), installed rupture disk, (1 pc) O-ring (RPI Part #RX0054), (2) O-rings, (1 pc) High Temp Lubricant (RPI Part #RPL090), and mounting hardware
- Also available: Pliers (Soft Jaw) (RPI Part #RXT005) used to grip Ultra-Torr® Fittings

Fits: Vaporizer/Condenser Assembly

Model: 100NX

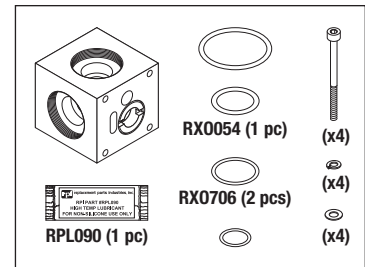

RPI Part #SDM081
OEM Part # (No OEM Part # Available)

VALVE MANIFOLD

- Includes installed rupture disk and all parts as shown
- Included in: Valve Manifold Assembly (RPI Part #SDA048) and Valve Manifold Assembly (RPI Part #SDA082)
- Also available: Pliers (Soft Jaw) (RPI Part #RXT005) used to grip Ultra-Torr® Fittings, Transition Valve (RPI Part #SDV046), and Inlet Valve (RPI Part #SDV047)

Fits: Vaporizer/Condenser Assembly

Models: NX & 100NX

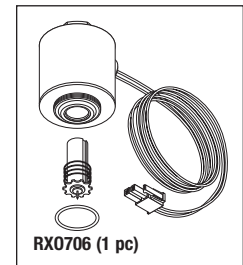

RPI Part #SDV046
OEM Part #40-54257-001

TRANSITION VALVE

- Manifold mount
- 24VDC, 14W (40-42 Ω); 22" lg. wire with Molex connector
- Material: Viton®/FKM seals
- Included in: Valve Manifold Assembly (RPI Part #SDA048)
- Also available: Spanner Nut (RPI Part #ILS014) and Double Ended Spanner Wrench (RPI Part #RPT501)

Fits: Vaporizer/Condenser Assembly

Models: NX

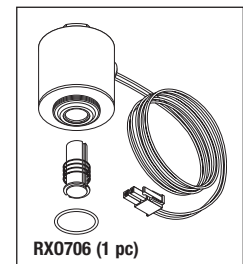

RPI Part #SDV047
OEM Part #28-51428-002

INLET VALVE

- Manifold mount
- 24VDC, 10W (59-61 Ω); 22" lg. wire with Molex connector
- Material: Viton®/FKM seals
- Included in: PM-1 Kit (RPI Part #SDK058), PM-2 Kit (RPI Part #SDK059), Valve Manifold Assembly (RPI Part #SDA048), and Valve Manifold Assembly (RPI Part #SDA082)
- Also available: Spanner Nut (RPI Part #ILS014) and Double Ended Spanner Wrench (RPI Part #RPT501)

Fits: Vaporizer/Condenser Assembly

Models: NX & 100NX

Sterilization Systems

Models: NX, 100NX & 100S (continued)

RPI Part #RX0054

OEM Part # (No OEM Part # Available)

Industry Part #AS568-116

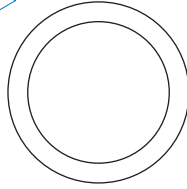

SHOWN
ACTUAL SIZE

O-RING

- 3 per package
- Size: .737" ID x .943" OD x .103" C/S
- Material: Viton®/FKM
- Included in: Valve Manifold (RPI Part #SDM081), Valve Manifold Assembly (RPI Part #SDA048), and Valve Manifold Assembly (RPI Part #SDA082)

Fits: Ultra-Torr® Fittings

Models: NX, 100NX

RPI Part #RXT005

OEM Part # (No OEM Part # Available)

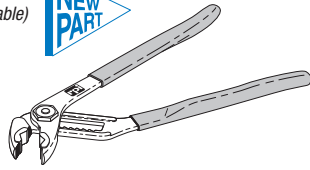

PLIERS (SOFT JAW)

- These adjustable pliers are ideal for gripping and protecting delicate surfaces without scarring.
- 1.75" max opening; 10" lg.
- Also available: Replacement Pads (RPI Part #RXT006)

Models: NX, 100NX & 100S

RPI Part #RXT006

OEM Part # (No OEM Part # Available)

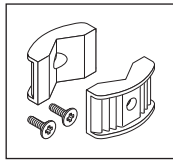

REPLACEMENT PADS

- Material: Nylon pads
- Includes: 2 replacement pads and mounting hardware
- Also available: Pliers (Soft Jaw) (RPI Part #RXT005)

Models: NX, 100NX & 100S

RPI Part #RXT020

OEM Part # (No OEM Part # Available)

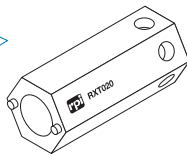

SPANNER WRENCH

- Size: 1.25" Hex x 3.00" lg.
- Material: Blue anodized aluminum
- Note: Holes through hex body allow use of a screwdriver as a leverage handle.

Fits: Vent Valve

Models: NX, 100NX & 100S

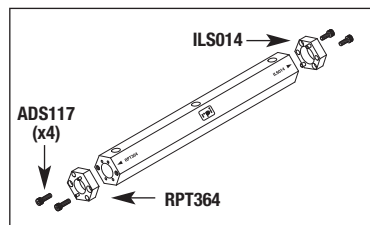

RPI Part #RPT501

OEM Part # (No OEM Part # Available)

DOUBLE ENDED SPANNER WRENCH

- Size: .875" HEX x ~7" lg.
- Material: Aluminum handle with stainless steel end attachments
- Includes all parts as shown
- Reversible and replaceable end attachments allow easy replacement of damaged pins
- Holes thru handle allow use of screwdriver as a leverage handle

Models: NX, 100NX & 100S

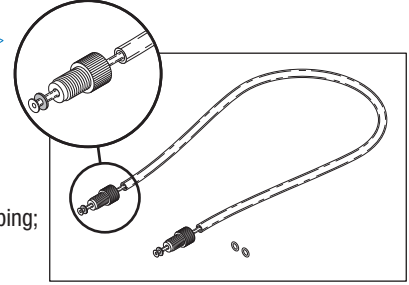

RPI Part #SDA071

OEM Part #108892-01

TUBING ASSEMBLY (H202 DELIVERY - 19" LG)

- Material: PTFE and silicone tubing; 316 stainless steel fittings
- Includes: (2) O-rings

Fits: H202 Delivery Assembly

Model: NX

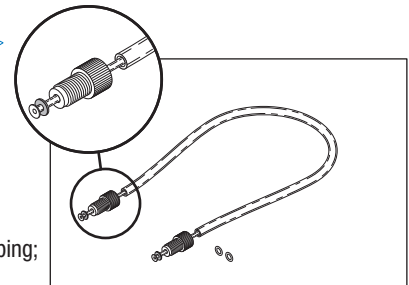

RPI Part #SDA079

OEM Part #27-53249-003

TUBING ASSEMBLY (H202 DELIVERY - 16.50" LG)

- Material: PTFE and silicone tubing; 316 stainless steel fittings
- Includes: (2) O-rings
- Also available: Tubing Assembly (H202 Delivery - 22" LG) (RPI Part #SDA080) and Tubing Assembly (H202 Delivery - 38.50" LG) (RPI Part #SDA068)

Fits: DUO Module

Model: 100NX

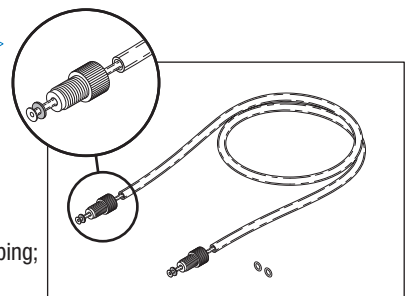

RPI Part #SDA080

OEM Part #27-53249-004

TUBING ASSEMBLY (H202 DELIVERY - 22" LG)

- Material: PTFE and silicone tubing; 316 stainless steel fittings
- Includes: (2) O-rings
- Also available: Tubing Assembly (H202 Delivery - 16.50" LG) (RPI Part #SDA079) and Tubing Assembly (H202 Delivery - 38.50" LG) (RPI Part #SDA068)

Fits: DUO Module

Model: 100NX

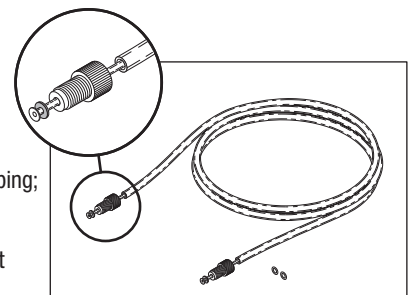

RPI Part #SDA068

OEM Part #27-53249-001

TUBING ASSEMBLY (H202 DELIVERY - 38.50" LG)

- Material: PTFE and silicone tubing; 316 stainless steel fittings
- Includes: (2) O-rings
- Included in: PM-2 Kit (RPI Part #SDK059)
- Also available: Tubing Assembly (H202 Delivery - 16.50" LG) (RPI Part #SDA079) and Tubing Assembly (H202 Delivery - 22" LG) (RPI Part #SDA080)

Fits: H202 Delivery Assembly or DUO Module

Models: 100NX

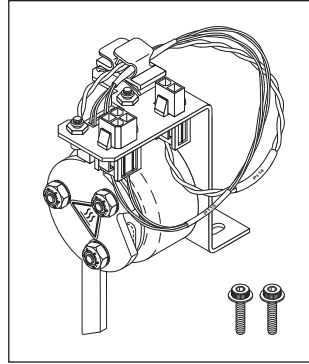

RPI Part #SDA041
OEM Part #03-52002-0-001

DOOR LOCK ASSEMBLY

- Includes: Rotary solenoid, mounting bracket, Door Lock Sensor (RPI Part #SDS042) and mounting screws
- Coil: 24 VAC, 30.48Ω @ 20°C

Fits: Top of Chassis

Model: NX

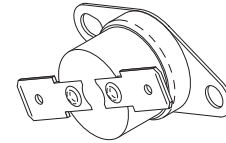

RPI Part #SDT045
OEM Part # (No OEM Part # Available)

THERMOSTAT

- Automatic reset
- Opens @ 194°F (90°C)
- Closes @ 158°F (70°C)
- 15A @ 120VAC; 10A @ 250VAC
- 1/4" tabs

Fits: Vaporizer/Condenser Assembly

Models: NX & 100NX

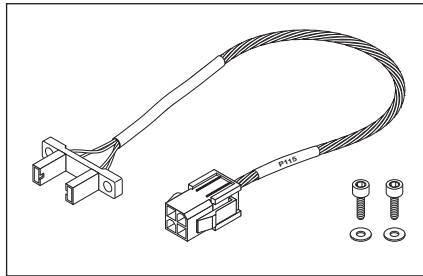

RPI Part #SDS042
OEM Part # (No OEM Part # Available)

DOOR LOCK SENSOR

- Includes: Mounting hardware
- Cable length: 8.75"
- Included in: Door Lock Assembly (RPI Part #SDA041)

Fits: Door Locking Solenoid Assembly

Model: NX

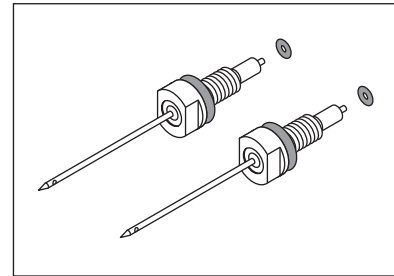

RPI Part #SDN073
OEM Part # (No OEM Part # Available)

NEEDLE H2O2 TRANSFER

- 2 per package
- Includes: (4) O-rings

Fits: Injector Valve Assembly

Model: 100S

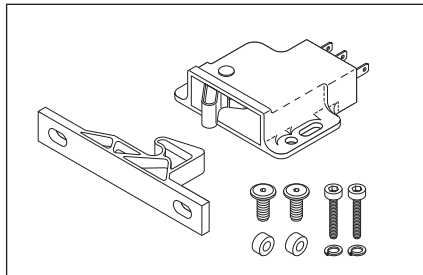

RPI Part #SDK053
OEM Part #74-51398-001, 74-51398

DOOR LATCH KIT

- Push to close latch (Catch and Keeper)
- Includes built-in single pole double throw switch and mounting hardware

Fits: NX Door Frame

Model: NX

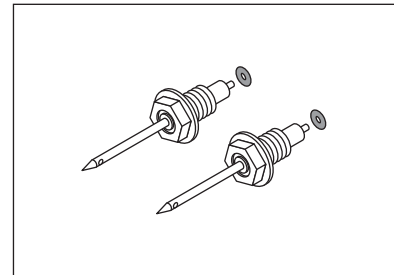

RPI Part #SDN062
OEM Part #06-52675-0-001 (Needle), 22-00537-001 (O-ring)

NEEDLE H2O2 TRANSFER

- 2 per package
- Includes: (2) O-rings
- Included in: PM-2 Kit (RPI Part #SDK059)

Fits: H2O2 Delivery Assembly

Models: NX & 100NX

Sterilization Systems

Models: NX, 100NX & 100S (continued)

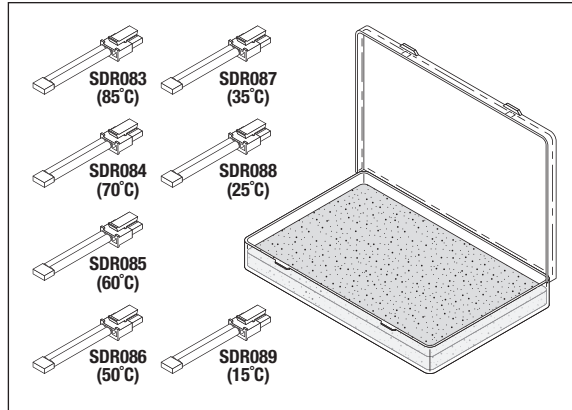
**RPI Part #SDK069**
OEM Part #04-52695-0-001**CALIBRATION RESISTOR KIT**

- Includes all 1% precision resistor values necessary to complete the Temperature Calibration procedure.
- Includes: Calibration Resistor (85°C) (RPI Part #SDR083), Calibration Resistor (70°C) (RPI Part #SDR084), Calibration Resistor (60°C) (RPI Part #SDR085), Calibration Resistor (50°C) (RPI Part #SDR086), Calibration Resistor (35°C) (RPI Part #SDR087), Calibration Resistor (25°C) (RPI Part #SDR088), and Calibration Resistor (15°C) (RPI Part #SDR089)

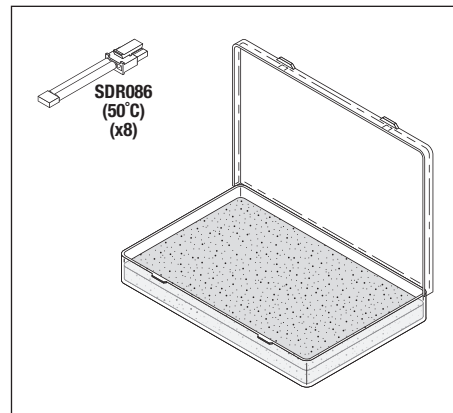
Fits: Electronics Module
Model: NX**RPI Part #SDK070**
OEM Part #04-54742-0-001**CALIBRATION RESISTOR KIT**

- Includes all 1% precision resistors necessary to complete the Temperature Calibration procedure.
- Includes: (8) Calibration Resistor (50°C) (RPI Part #SDR086)

Fits: Electronics Module
Model: 100NX**RPI Part #SDR083**
OEM Part # (No OEM Part # Available)**CALIBRATION RESISTOR (85°C)**

- 1.07K $\Omega \pm 0.1\%$ precision resistor
- Included in: Calibration Resistor Kit (RPI Part #SDK069)

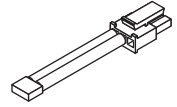
Fits: Electronics Module
Model: NX**RPI Part #SDR084**
OEM Part # (No OEM Part # Available)**CALIBRATION RESISTOR (70°C)**

- 1.752K $\Omega \pm 0.1\%$ precision resistor
- Included in: Calibration Resistor Kit (RPI Part #SDK069)

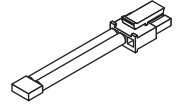
Fits: Electronics Module
Model: NX**RPI Part #SDR085**
OEM Part # (No OEM Part # Available)**CALIBRATION RESISTOR (60°C)**

- 2.487K $\Omega \pm 0.1\%$ precision resistor
- Included in: Calibration Resistor Kit (RPI Part #SDK069)

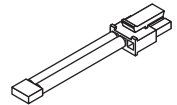
Fits: Electronics Module
Model: NX**RPI Part #SDR086**
OEM Part # (No OEM Part # Available)**CALIBRATION RESISTOR (50°C)**

- 3.60K $\Omega \pm 0.1\%$ precision resistor
- Included in: Calibration Resistor Kit (RPI Part #SDK069) and Calibration Resistor Kit (RPI Part #SDK070)

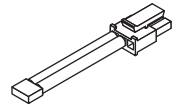
Fits: Interface PCB
Models: NX & 100NX**RPI Part #SDR087**
OEM Part # (No OEM Part # Available)**CALIBRATION RESISTOR (35°C)**

- 6.53K $\Omega \pm 0.1\%$ precision resistor
- Included in: Calibration Resistor Kit (RPI Part #SDK069)

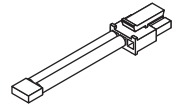
Fits: Electronics Module
Model: NX**RPI Part #SDR088**
OEM Part # (No OEM Part # Available)**CALIBRATION RESISTOR (25°C)**

- 10.0K $\Omega \pm 7 0.1\%$ precision resistor
- Included in: Calibration Resistor Kit (RPI Part #SDK069)

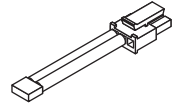
Fits: Electronics Module
Model: NX**RPI Part #SDR089**
OEM Part # (No OEM Part # Available)**CALIBRATION RESISTOR (15°C)**

- 15.716K $\Omega \pm 0.1\%$ precision resistor
- Included in: Calibration Resistor Kit (RPI Part #SDK069)

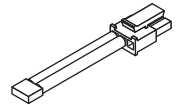
Fits: Electronics Module
Model: NX



MORE NEW PARTS TO FIT STERRAD NX, 100NX & 100S

HYDROGEN PEROXIDE STERILIZATION SYSTEMS!



RPI Part #SDK050
OEM Part #02-52410-X-XXX

VAPORIZER/CONDENSER SERVICE KIT

- Includes: Insulation Block Kit (RPI Part #SDK093), Valve Manifold Assembly (RPI Part #SDA048), Wire Brush (Scrubbing) (RPI Part #RXB059), Wire Brush (1/2" Dia.) (RPI Part #RXB060), Cleanout Tool (.030") (RPI Part #RXT062), (1 pc) Heat Sink Compound (RPI Part #RPC464), (2) O-Rings, (2) cleaning pads and mounting hardware
- Also available: Vacuum Test Gauge Kit (RPI Part #SDK112), Pliers (Soft Jaw) (RPI Part #RXT005) and Insulation Blanket (RPI Part #SDB094)

Fits: Vaporizer/Condenser Assembly
Models: NX

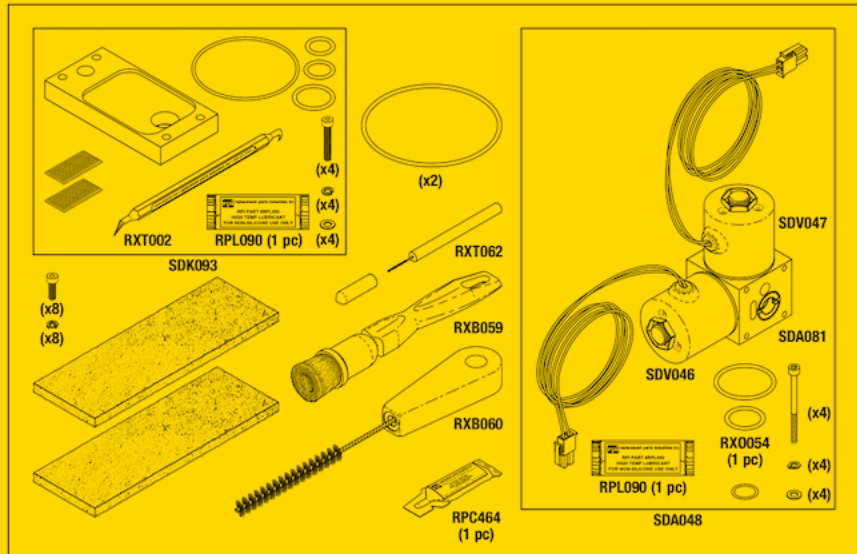

RPI Part #SDK051
OEM Part # (No OEM Part # Available)

VAPORIZER/CONDENSER SERVICE KIT

- Includes: Insulation Block Kit (RPI Part #SDK093), Valve Manifold Assembly (RPI Part #SDA082), Wire Brush (Scrubbing) (RPI Part #RXB059), Wire Brush (1/2" Dia.) (RPI Part #RXB060), Cleanout Tool (.030") (RPI Part #RXT062), (1 pc) Heat Sink Compound (RPI Part #RPC464), (6) O-Rings, (2) Cleaning pads and mounting hardware
- Also available: Vacuum Test Gauge Kit (RPI Part #SDK112), Pliers (Soft Jaw) (RPI Part #RXT005) and Insulation Blanket (RPI Part #SDB097)

Fits: Vaporizer/Condenser Assembly
Models: 100NX

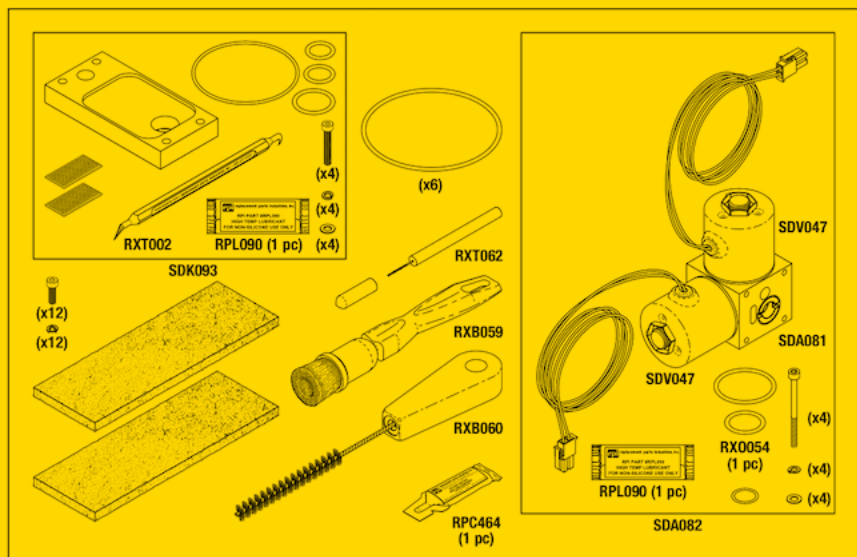

RPI Part #SDK093
OEM Part # (No OEM Part # Available)



INSULATION BLOCK KIT

- Includes: Insulation block, (1 pc) High Temperature lubricant (RPI Part #RPL090), O-Ring Removal Tool (RPI Part #RXT002), (2 pcs) velcro pads (hook only), (4) O-Rings and mounting hardware
- Also available: Insulation Blanket (RPI Part #SDB094), Insulation Blanket (RPI Part #SDB097), Vacuum Test Gage Kit (RPI Part #SDK112) and Pliers (Soft Jaw) (RPI Part #RXT005)

Fits: Vaporizer/Condenser Assembly
Models: NX & 100NX

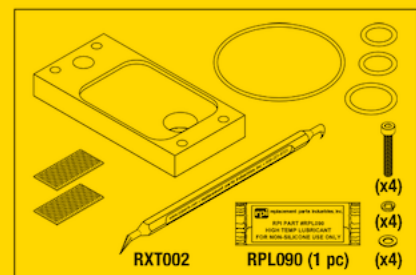

replacement parts industries, inc.

CALL (800) 221-9723 • FAX (818) 882-7028 • EMAIL order@rpiparts.com • WEBSITE www.rpiparts.com

The above parts are manufactured by Replacement Parts Industries, Inc. to fit the equipment noted. All product names used in this document are trademarks or registered trademarks of their respective holders. Flyer Code 1905SD Rdt SHOW 07/20

RPI Part #SDK090

OEM Part # (No OEM Part # Available)



INJECTOR ASSEMBLY REBUILD KIT

- Includes: Wire Brush (Scrubbing) (RPI Part #RXB059), (1 pkg) Needle H2O2 Transfer (RPI Part #SDN073), (1 pc) High Temp Lubricant (RPI Part #RPL090), (2) needle guides and bushings, (3) compression springs, diaphragm, sealing washer, (3) O-Rings, (2) cleaning pads and retaining ring

Fits: Injector Assembly

Models: 100S

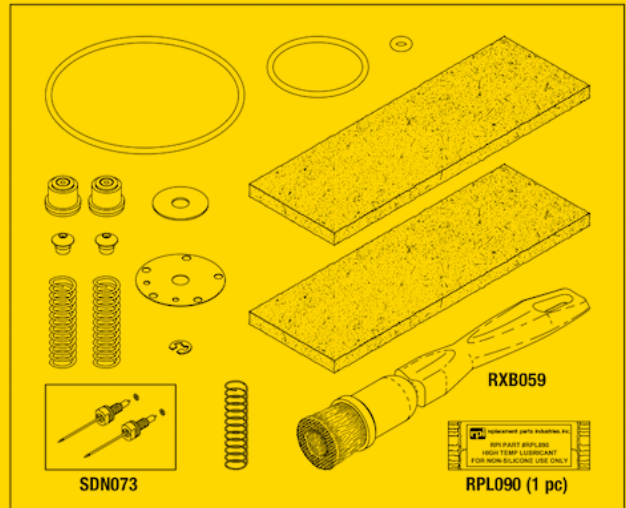

RPI Part #SDK091

OEM Part # (No OEM Part # Available)



INJECTOR ASSEMBLY TOOL KIT

- Includes: Needle Aligner (RPI Part #SDT110), Bushing Retainer (RPI Part #SDT111), O-Ring Removal/Gage Tool (RPI Part #RXT082), Cleanout Tool (.067") (RPI Part #RXT061) and Spanner Wrench (RPI Part #RXT044)
- Custom tools used to install the needles into the Injector Valve Assembly and disassemble/clean the Injector Base

Fits: Injector Valve Assembly

Models: 100S

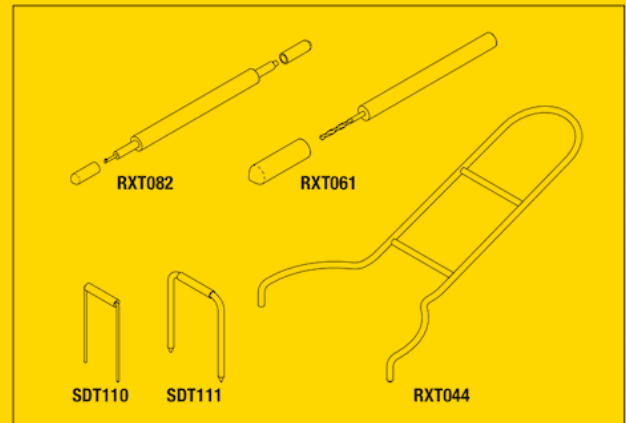

RPI Part #RXT044

OEM Part # (No OEM Part # Available)



SPANNER WRENCH

- Size: 6.25" lg. x 2.63" span
- Material: .120" dia. stainless steel spring wire

Fits: Injector Housing

Models: 100S

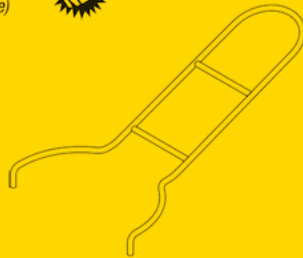

RPI Part #RXT061

OEM Part # (No OEM Part # Available)



CLEANOUT TOOL (.067")

- Size: .067" dia. drill bit x 1/4" dia., plastic body
- Includes: Protective vinyl cap

Fits: Injector Valve Assembly

Models: 100S

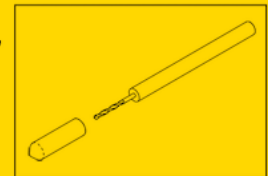

RPI Part #RXT082

OEM Part # (No OEM Part # Available)



O-RING REMOVAL/GAGE TOOL

- Size: 3.75" lg. x 1/4" dia., plastic body
- Includes: (2) Protective vinyl caps
- Used to check for existing O-Rings and remove them from the Injector Assembly.

Fits: Injector Assembly

Models: 100S

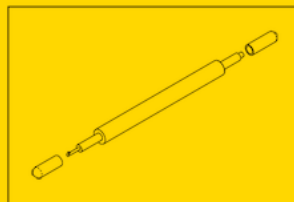

RPI Part #SDT110

OEM Part # (No OEM Part # Available)



NEEDLE ALIGNER

- Size: 1.50" L x .75" W
- Material: Stainless steel

Fits: Injector Assembly Needle Bushings

Models: 100S



RPI Part #SDT111

OEM Part # (No OEM Part # Available)



BUSHING RETAINER

- Size: 1.50" L x 1.12" W
- Material: Stainless steel

Fits: Injector Assembly

Models: 100S





RPI Part #SDK112

OEM Part # (No OEM Part # Available)



VACUUM TEST GAUGE KIT

- Includes all parts as shown
- All parts also sold separately

Fits: Pressure Control Manifold

Models: NX, 100NX & 100S

RPI Part #RXG039

OEM Part #35-04264-001



VACUUM TEST GAUGE

- Includes: Gauge, 9VDC battery, and storage case
- Brand: Inficon
- Range: Atmosphere to 1 Micron
- Display units: Microns, Pascal, Millibar and Torr
- Also available: Centering Ring (16KF) (RPI Part #RXR042) and Clamp (10KF & 16KF) (RPI Part #RXC063)

Fits: 16KF flange

Models: NX, 100NX & 100S



RPI Part #RXR042

OEM Part #30-09399-0-001



CENTERING RING (16KF)

- Size: 16KF (16mm, "KF" style)
- Material: 303 Stainless steel hub with (1 pc) Viton® (FKM) O-Ring (RPI Part #RX0043)
- Also available: Clamp (10KF & 16KF) (RPI Part #RXC063)

Fits: K16 Flange

Models: NX, 100NX & 100S

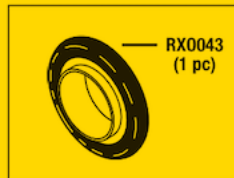

RPI Part #RX0043

OEM Part # (No OEM Part # Available)



O-RING

- 3 per package
- Size: 18mm (.709") ID x 28mm (1.102") OD x 5mm (.197") C/S
- Material: Viton® (FKM); 75 Duro
- Included in: Centering Ring (16KF) (RPI Part #RXR042)

Fits: 16KF Centering Ring

Models: NX, 100NX, 100S

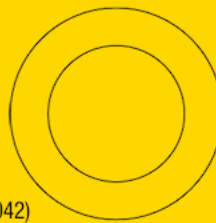

RPI Part #RXC063

OEM Part # (No OEM Part # Available)



CLAMP (10KF & 16KF)

- Size: fits 10KF and 16KF fittings
- Material: Aluminum body
- Also available: Centering Ring (16KF) (RPI Part #RXR042)

Fits: Vacuum Pump Assembly

Models: 100S, 100NX & NX

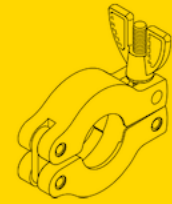

RPI Part #SDF092

OEM Part #30-09256-X-001



ADAPTOR FITTING

- Size: 16KF flange x 7/16-20 thread
- Material: Stainless steel with (1pc) Viton® (FKM) O-Ring (RPI Part #RP0972)
- Also available: Centering Ring (16KF) (RPI Part #RXR042) and Clamp (10KF & 16KF) (RPI Part #RXC063)

Fits: Vacuum Manifold

Models: NX & 100NX

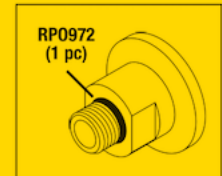

RPI Part #RP0972

OEM Part # (No OEM Part # Available)



Industry Part #AS568-012

O-RING

- 12 per package
- Size: .364" ID x .504" OD x .070" C/S
- Material: Viton® (FKM); 75 Duro

Fits: Adapter Fitting and Hex Port Plug

Models: NX & 100NX



RPI Part #RXF078

OEM Part # (No OEM Part # Available)



VACUUM REDUCER TEE

(1" x 1" x 3/4")

- Connection: fits 25KF x 25KF x 16KF flange
- Material: Stainless steel

Fits: Vacuum Pump Assembly

Models: 100S

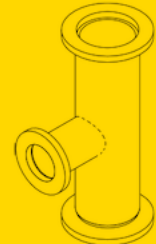

RPI Part #RXF079

OEM Part # (No OEM Part # Available)



VACUUM RADIUS ELBOW (3/4")

- Connection: 16KF flange
- Material: Stainless steel

Fits: Vacuum Pump Assembly

Models: 100S



RPI Part #RPL615

OEM Part # (No OEM Part # Available)

O-RING LUBRICANT

- 2 oz. tube
- Non-Toxic; Super-O-Lube® made by Parker
- Temperature Range: -65° to 400° F
- Can be used on silicone and non-silicone rubber materials

Models: NX, 100NX & 100S



RPI Part #SDN073**OEM Part #** (No OEM Part # Available)**NEEDLE H202 TRANSFER**

- 2 per package
- Includes: (4) O-rings
- Fits:** Injector Valve Assembly
- Model:** 100S

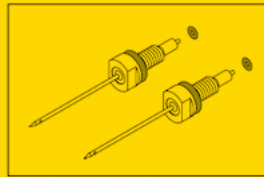
**RPI Part #SDF098****OEM Part #** #21-01104-040**SCREEN FILTER**

- Size: 40KF (40mm, "KF" style)
- Material: Stainless steel centering ring with a 30 mesh stainless steel screen and (1 pc) Viton® (FKM) O-Ring (RPI Part #RX0081)

Fits: Vacuum Assembly
Models: 100NX & 100S

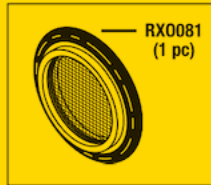
**RPI Part #RXB059****OEM Part #** (No OEM Part # Available)**WIRE BRUSH (SCRUBBING)**

- Size: 6" body with 1" dia. bristle
- Material: Galvanized stainless steel bristles
- Fits:** Vaporizer Service Kit
- Models:** NX, 100NX & 100S

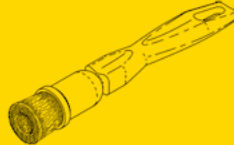
**RPI Part #RXB060****OEM Part #** (No OEM Part # Available)**WIRE BRUSH (1/2" DIA)**

- Size: 8" body with 1/2" dia. medium stiffness bristles
- Material: Brass bristles
- Fits:** Vaporizer Service Kit
- Models:** NX & 100NX

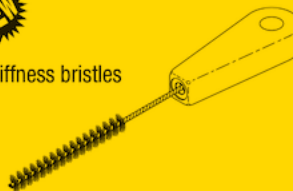
**RPI Part #RXT062****OEM Part #** (No OEM Part # Available)**CLEANOUT TOOL (.030")**

- Size: .030" dia. drill bit x 1/4" dia., plastic body
- Includes: Protective vinyl cap
- Fits:** Vaporizer/Condenser Assembly
- Models:** NX & 100NX

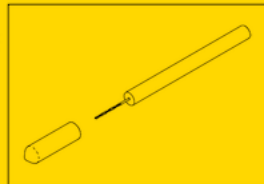
**RPI Part #RPC464****OEM Part #** (No OEM Part # Available)**HEAT SINK COMPOUND**

- 5 per package; Size: .07 fl. oz (2ml)
- Non-Silicone based thermal grease
- Models:** NX & 100NX

**RPI Part #RPL090****OEM Part #** (No OEM Part # Available)**HIGH TEMP LUBRICANT**

- 5 per package; 1/2 gram per unit
- Temperature range: -40°F to +400°F (-40°C to +204°C)
- Models:** NX, 100NX & 100S

**RPI Part #RX0081****OEM Part #** (No OEM Part # Available)**O-RING**

- 3 per package
- Size: 42mm (1.653") ID x 52mm (2.047") OD x 5mm (.197") C/S
- Material: Viton® (FKM); 75 Duro
- Fits:** 40KF Centering Ring
- Models:** 100S

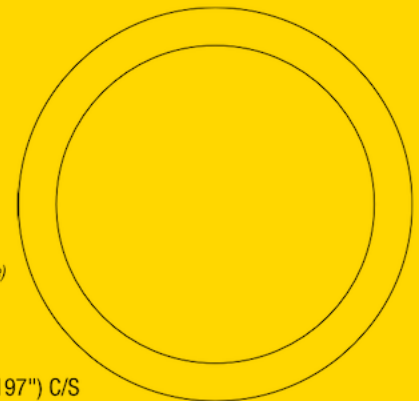
SHOWN
ACTUAL SIZE**RPI Part #RX0080****OEM Part #** (No OEM Part # Available)**O-RING**

- 3 per package
- Size: 28mm (1.020") ID x 38mm (1.496") OD x 5mm (.197") C/S
- Material: Viton® (FKM); 75 Duro
- Fits:** 25KF Centering Ring
- Models:** 100S

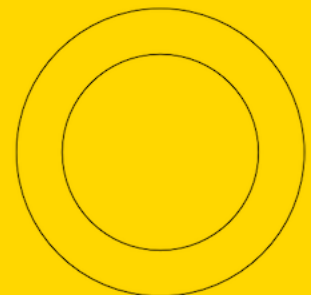
SHOWN
ACTUAL SIZE**RPI Part #RXT002****OEM Part #** (No OEM Part # Available)**O-RING REMOVAL TOOL**

- Made from Nylon® to avoid scratching delicate O-Ring sealing surfaces
- Size: 5.5"
- Models:** NX, 100NX & 100S

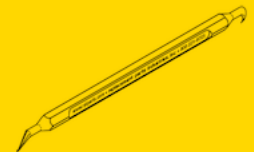
**RPI Part #RXT005****OEM Part #** (No OEM Part # Available)**PLIERS (SOFT JAW)**

- These adjustable pliers are ideal for gripping and protecting delicate surfaces without scarring.
- 1.75" max opening; 10" lg.
- Also available: Replacement Pads (RPI Part #RXT006)
- Models:** NX, 100NX & 100S

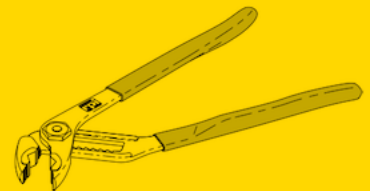
**RPI Part #RXT020****OEM Part #** (No OEM Part # Available)**SPANNER WRENCH**

- Size: 1.25" Hex x 3.00" lg.
- Material: Blue anodized aluminum
- Note: Holes through hex body allow use of a screwdriver as a leverage handle.
- Used to install/rebuild Solenoid Valves (RPI Part #'s SDV031, SDV049, SDV096 and SDK052)
- Fits:** Vent Valve
- Models:** 100S, NX & 100NX

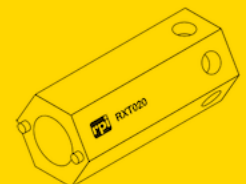



RPI Part #SDV031
OEM Part # (No OEM Part # Available)

SOLENOID VALVE

- 12VDC, 16W (10Ω)
- Material: Viton® (FKM) seals
- Also available: Solenoid Valve Rebuild Kit (RPI Part #SDK052) and Spanner Wrench (RPI Part #RXT020)

Fits: Vent Valve Assembly
Models: 100NX

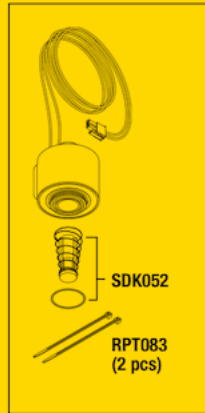

RPI Part #SDF072
OEM Part # (No OEM Part # Available)

FAN

- 24VDC; 4300 RPM
- Size: 4.68" Sq. x 1.50" Thk.
- Material: Glass reinforced plastic, black finish; ball bearing construction
- Includes: heat shrink tubing

Fits: Vaporizer/Condenser Assembly

Models: 100NX

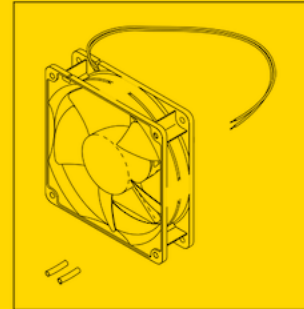

RPI Part #SDV049
OEM Part # (No OEM Part # Available)

SOLENOID VALVE

- 24VDC, 15W (39Ω)
- Material: Viton® (FKM) seals
- Also available: Solenoid Valve Rebuild Kit (RPI Part #SDK052) and Spanner Wrench (RPI Part #RXT020)

Fits: Vent Valve Assembly
Models: NX



RPI Part #SDF095
OEM Part # (No OEM Part # Available)

FAN

- 24VDC; 2750 RPM
- Size: 4.72" Sq. x 1.25" Thk.
- Material: Glass reinforced plastic, black finish; ball bearing construction
- Includes: (1pc) Cable Tie (8" Black) (RPI Part #RPT279) and (4 pcs) Rivet (RPI Part #RXR064)

Fits: Vaporizer/Condenser Assembly

Models: NX

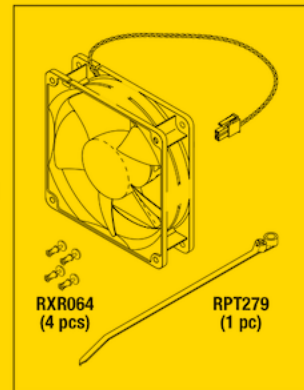

RPI Part #SDV096
OEM Part # (No OEM Part # Available)

SOLENOID VALVE

- 120VAC, 18W (41Ω)
- Material: Viton® (FKM) seals
- Also available: Solenoid Valve Rebuild Kit (RPI Part #SDK052) and Spanner Wrench (RPI Part #RXT020)

Fits: Vacuum Manifold Assembly and Oil Recovery Valve
Models: 100S

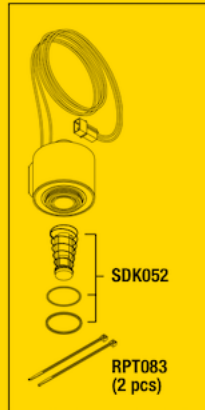

RPI Part #RXR064
OEM Part # (No OEM Part # Available)

RIVET

- 6 per package
- Fits hole dia.: .163"; Panel Thk: .188"
- Material: Nylon® Color: Black
- Size: .250" dia. head x .220" lg.
- Included in: Fan (RPI Part #SDF095)

Fits: Vaporizer/Condenser Fan

Models: NX



RPI Part #SDK052
OEM Part # (No OEM Part # Available)

SOLENOID VALVE REBUILD KIT

- Viton® (FKM) seals
- Includes all parts as shown
- Included in: Solenoid Valve (RPI Part #SDV031), Solenoid Valve (RPI Part #SDV049) and Solenoid Valve (RPI Part #SDV096)
- Also available: Spanner Wrench (RPI Part #RXT020)

Fits: Solenoid Valve
Models: NX, 100NX & 100S

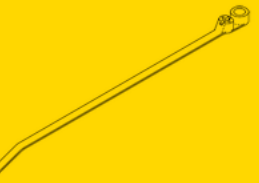
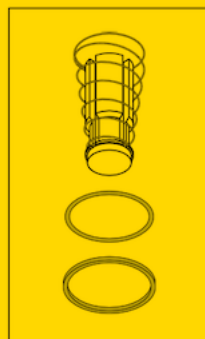

RPI Part #RPT279
OEM Part # (No OEM Part # Available)

CABLE TIE (8" BLACK)

- 25 per package
 - With #10 mounting hole
- Fits:** Vaporizer/Condenser Fan
Models: NX & 100NX



RPI Part #RPT083
OEM Part # (No OEM Part # Available)

CABLE TIE (4" WHITE)

- 25 per package
 - Material: Nylon®
- Models:** NX, 100NX & 100S



MORE NEW PARTS TO FIT STERRAD NX, 100NX & 100S

HYDROGEN PEROXIDE STERILIZATION SYSTEMS!

Now In Stock and Ready to Ship:

- Fans
- Injector Assembly Rebuild Kit
- Injector Assembly Tool Kit
- Insulation Blankets
- Insulation Block Kit
- Screen Filter
- Solenoid Valves
- Solenoid Valve Rebuild Kit
- Specialty Tools
- Vacuum Test Gauge Kit
- Vaporizer/Condenser Service Kits
- and more!

See inside for all of the new parts RPI offers to fit Sterrad NX, 100NX and 100S!



VACUUM TEST GAUGE KIT (RPI Part #SDK112)

NEW PARTS TO FIT STERRAD NX, 100NX, & 100S HYDROGEN PEROXIDE STERILIZATION SYSTEMS!

ADDRESS SERVICES REQUESTED

PERMIT NO. 2399
VAN NUYS, CA
U.S. POSTAGE PAID
PRESORTED STANDARD

rpi! replacement parts industries, inc.
625 Cochran Street • Simi Valley, California • 93065

RPI Part #SDB094
OEM Part # (No OEM Part # Available)



INSULATION BLANKET

- Size: 5.0" Wide x 11.00" Long x 3/32" Thick
 - Material: Flame retardant Aramid®
 - Includes: (2) Velcro strips (hook only)
- Fits:** Vaporizer/Condenser Assembly
Models: NX

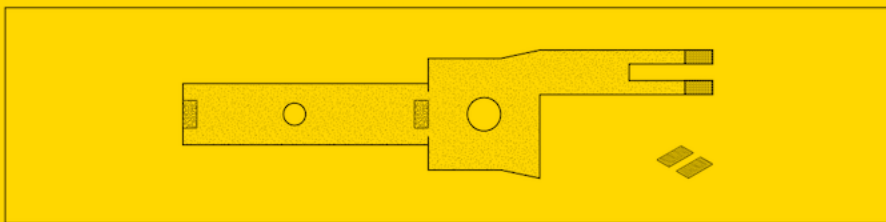

RPI Part #SDB097
OEM Part # (No OEM Part # Available)



INSULATION BLANKET

- Size: 5.0" Wide x 24.75" Long x 3/32" Thick
 - Material: Flame retardant Aramid®
 - Includes: (2) Velcro strips (hook only)
- Fits:** Vaporizer/Condenser Assembly
Models: 100NX

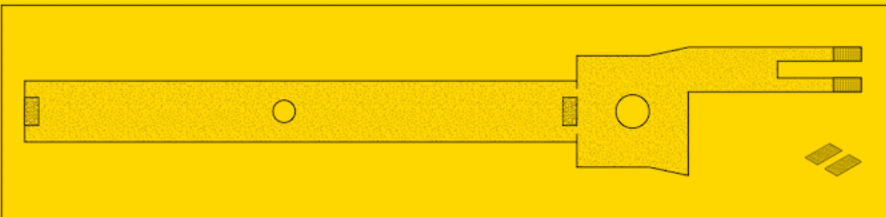



**Parts to fit
Sterrad NX, 100NX & 100S
Hydrogen Peroxide Sterilization Systems!**



**RPI Part #SDK100
OEM Part #35-53016-001**

NEUTRAL DENSITY FILTER KIT

- Includes all Neutral Density Filters necessary to complete the Optical Density Calibration procedure
- Includes individual certification of calibration for each lens
- Includes all parts as shown
- Also available: Optical Window Kit (RPI Part #SDK014), Detector Window Kit (RPI Part #SDK116), and UV Lamp Assembly (RPI Part #SDA006)

Fits: Optical Detector Assembly
Models: NX & 100NX



Neutral Density Filter Kit (RPI Part #SDK100) Includes All Parts Shown Below!



**RPI Part #SDF101
OEM Part # (No OEM Part # Available)**

NEUTRAL DENSITY FILTER (#1)

- 0.0400 Optical Density
- Fits:** Optical Detector Assembly
Models: NX & 100NX



**RPI Part #SDF103
OEM Part # (No OEM Part # Available)**

NEUTRAL DENSITY FILTER (#3)

- 0.2285 Optical Density
- Fits:** Optical Detector Assembly
Models: NX & 100NX



**RPI Part #SDF102
OEM Part # (No OEM Part # Available)**

NEUTRAL DENSITY FILTER (#2)

- 0.1475 Optical Density
- Fits:** Optical Detector Assembly
Models: NX & 100NX



**RPI Part #SDF104
OEM Part # (No OEM Part # Available)**

NEUTRAL DENSITY FILTER (#4)

- 0.4020 Optical Density
- Fits:** Optical Detector Assembly
Models: NX & 100NX



**RPI Part #RXT109
OEM Part # (No OEM Part # Available)**

OPTICAL LENS TOWLETTE

- 4 per package
 - Anti-static, anti-fog and Anti-streaking single use premoistened wipe
- Models:** NX & 100NX



**RPI Part #RXC110
OEM Part # (No OEM Part # Available)**

STORAGE CASE

- Size: 7.91" x 4.25" x 2.04"
- Models:** NX & 100NX



replacement parts industries, inc.

CALL (800) 221-9723 • FAX (818) 882-7028 • EMAIL order@riparts.com • WEBSITE www.riparts.com

The above parts are manufactured by Replacement Parts Industries, Inc. to fit the equipment noted. All product names used in this document are trademarks or registered trademarks of their respective holders. Flyer Code 2002SD Rd5 SHOW 07/21

New Parts to fit Sterrad NX & 100NX H2O2 Sterilization Systems



RPI Part #SDK116
OEM Part #32-03557-0-001

DETECTOR WINDOW KIT

- Includes: Lens and Viton® (FKM) O-Ring
- Fits:** Optical Detector Assembly
Models: NX & 100NX

LOOK INSIDE!

Also available: Neutral Density Filter Kit
 (RPI Part #SDK100) and More New Parts!



RPI Part #SDK014
OEM Part #32-51413-0-001/22-00537-209

OPTICAL WINDOW KIT

- Includes: (2) Optical windows and (1) Viton® (FKM) O-Ring
 - Included in: PM-2 Kit (RPI Part #SDK003)
- Fits:** Hydrogen Peroxide Monitor and Optical Detector Assembly
Models: NX & 100NX



RPI Part #SDA006
OEM Part #40-52125-001

UV LAMP ASSEMBLY

- Rated at 900 VRMS
 - 12" lg. cable with connector
 - Factory calibrated
 - Included in: PM-2 Kit (RPI Part #SDK003)
- Fits:** Hydrogen Peroxide Monitor and Optical Detector Assembly
Models: NX & 100NX

New Parts to fit Sterrad NX & 100NX H2O2 Sterilization Systems

ADDRESS SERVICES REQUESTED

PERMITTED NO. 2399
 VAN NUYS, CA
 U.S. POSTAGE PAID
 PRESORTED STANDARD

625 Cochran Street • Simi Valley, California • 93065
replacement parts industries, inc.



Also Available to fit the 100S

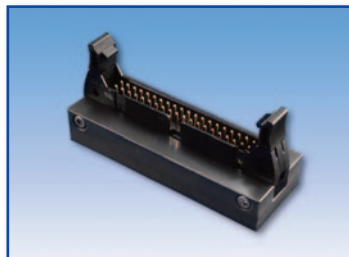

RPI Part #SDK117
OEM Part # (No OEM Part # Available)

SERVICE ACCESS KEY

- Used with Auto Test to gain access to the Service Mode
- Fits:** J2 Harness Connector
OEM: STERRAD
Models: 100S

Don't Forget ...

Essential tool to protect sensitive equipment during maintenance!

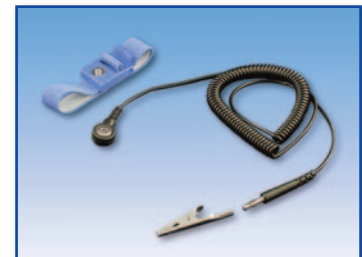

RPI Part #RPS998
OEM Part # (No OEM Part # Available)

GROUNDING STRAP

- For grounding to an ESD work bench or a chassis
 - Includes: Strap, 6' long coiled cord with banana plug and detachable alligator clamp
- Models:** NX & 100NX



... Proud to be a Healthcare Components Group company ...



HEALTHCARE
Components Group

STERRAD

New Oil Return Solenoid Valves to fit STERRAD[®] NX[®] & 100NX[®] Hydrogen Peroxide Sterilization Systems!



RPI Part #SDV105
OEM Part #28-51971-001

SOLENOID VALVE (OIL RETURN)

- 12VDC, 7W (80Ω); 24" lg. wires with 2 pin connector
- Material: Stainless steel body; Viton[®] (FKM) seals
- Includes: (2 pcs) Male Connector (1/4" Push-In x 1/8" MPT) (RPI Part #RXF117)
- Also available: Solenoid Valve Repair Kit (RPI Part #SDK107) and Coil (RPI Part #SDC108)

Fits: Vacuum Pump Chassis
Models: NX



RPI Part #SDV106
OEM Part #28-51498-001

SOLENOID VALVE (OIL RETURN)

- 12VDC, 7W (80Ω); 24" lg. wires with 2 pin connector
- Material: Stainless steel body; Viton[®] (FKM) seals
- Includes: Vacuum fitting, face seal O-Ring (RPI Part #RXO091) and (1 pc) Male Connector (1/4" Push-In x 1/8" MPT) (RPI Part #RXF117)
- Also available: Solenoid Valve Repair Kit (RPI Part #SDK107) and Coil (RPI Part #SDC108)

Fits: Vacuum Pump Chassis
Models: 100NX



RPI Part #SDC108
OEM Part # (No OEM Part # Available)

COIL

- 12VDC, 7W (80Ω); 24" lg. wires with (2) installed contacts and 2 pin connector (not installed)
- Also available: Solenoid Valve (Oil Return) (RPI Part #SDV105), Solenoid Valve (Oil Return) (RPI Part #SDV106), and Solenoid Valve Repair Kit (RPI Part #SDK107)

Fits: Solenoid Valve (Oil Return)
Models: NX & 100NX



RPI Part #SDK107
OEM Part # (No OEM Part # Available)

SOLENOID VALVE REPAIR KIT

- Viton[®] (FKM) seals
- Includes: Spanner wrench
- Also available: Solenoid Valve (Oil Return) (RPI Part #SDV105), Solenoid Valve (Oil Return) (RPI Part #SDV106), and Coil (RPI Part #SDC108)

Fits: Solenoid Valve (Oil Return)
Models: NX & 100NX



RPI Part #RXF117
OEM Part #26-00391-043

MALE CONNECTOR (1/4" PUSH-IN X 1/8" MPT)

- 2 per package
- Material: Nickel plated brass
- Included in: Solenoid Valve (Oil Return) (RPI Part #SDV105) and Solenoid Valve (Oil Return) (RPI Part #SDV106)

Fits: Solenoid Valve (Oil Return)
Models: NX & 100NX

x2



RPI Part #RXO091
OEM Part # (No OEM Part # Available)

O-RING

- 6 per package
- Size: .239" ID x .379" OD x .070" C/S; Duro 75
- Material: Viton[®] (FKM)
- Included in: Solenoid Valve (Oil Return) (RPI Part #SDV106)

Fits: Solenoid Valve (Oil Return)
Models: 100NX

x6



replacement parts industries, inc. A Healthcare Components Group Company

CALL (800) 221-9723 • FAX (818) 882-7028 • EMAIL order@rpiparts.com • WEBSITE www.rpiparts.com

The above parts are manufactured by Replacement Parts Industries, Inc. to fit the equipment noted. All product names used in this document are trademarks or registered trademarks of their respective holders. 2109SD Web 01/23

SECTION

10

PAGE

538

UPDATED

01/23

NEW PART For **Pelton & Crane**

RPI Part #PCC249
OEM Part #047508 (Omni Cleaner Plus™)

PEL-CLEAN™

- Sterilizer cleaning solution
- (1) 16 oz. bottle

Models: Pelton & Crane sterilizers



• Also available by the case of 12 bottles!
Just ask for PEL-CLEAN™ (CASE)
(RPI Part #PCC250)

NEW PART **Sterilizer Cleaning Kit**

RPI Part #RPK791
OEM Part # (No OEM Part # Available)

CLEANING KIT

- Supplied in a convenient sturdy canvas Carrying Case (RPI Part #RPC799)
- Includes all parts as shown
- All items also sold separately (see chart below)

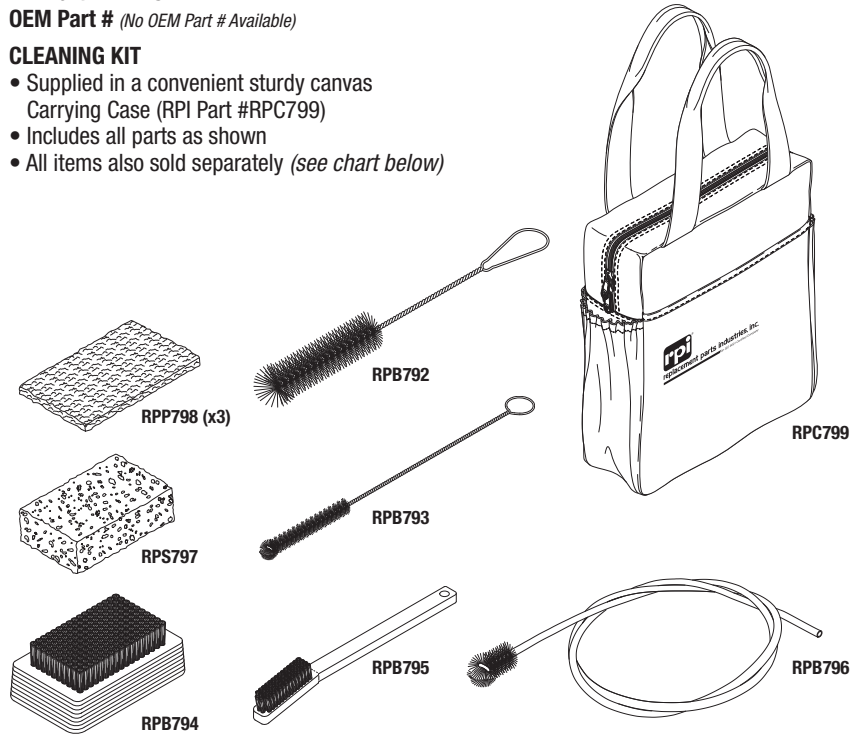

RPI Part #	Description (see Page 10-551 for details)	Kit Quantity	Reorder Quantity
RPB792	LARGE DIA. BRUSH (1-3/4")	1	1
RPB793	SMALL DIA. BRUSH (3/8")	1	1
RPB794	SCRUB BRUSH	1	1
RPB795	HANDLE BRUSH	1	1
RPB796	FLEXIBLE TUBE BRUSH (7/8")	1	1
RPC799	CARRYING CASE	1	1
RPP798	CLEANSING PAD	3	3
RPS797	SPONGE (4-1/4" x 6")	1	3

NEW PART For **Midmark® • Ritter®**

RPI Part #MIC143
OEM Part #002-0396-00 (Speed Clean)

MID-CLEAN™

- Sterilizer cleaning solution
- (1) 16 oz. bottle

Models: Midmark® • Ritter® sterilizers



• Also available by the case of 12 bottles!
Just ask for MID-CLEAN™ (CASE)
(RPI Part #MIC144)

NEW PART For **SciCan®**

RPI Part #SCA046
OEM Part #80ZPLUS (Stat-Dri Plus™) / 320ZPLUS (Stat-Dri Plus™)

SCI-DRY™ (16 oz. REFILL)

- Drying and rinse agent
- (1) 16 oz. bottle
- Also available: Sci-Dry™ (2 oz.) (RPI Part #SCA054)

Models: SciCan® 2000, 5000 & 7000 series cassette sterilizers; and Hydrim® series washers



• Also available by the case of 12 bottles!
Just ask for SCI-DRY™ (16 oz. REFILL - CASE) (RPI Part #SCA047)

RPI Part #SCA054
OEM Part #20ZPLUS (Stat-Dri Plus™) / 80ZPLUST (Stat-Dri Plus™)

SCI-DRY™ (2 oz.)

- Drying and rinse agent
- (1) 2 oz. spray bottle
- Also available: Sci-Dry™ (16 oz. Refill) (RPI Part #SCA046)

Models: SciCan® 2000, 5000 & 7000 series cassette sterilizers



• Also available by the case of 12 bottles!
Just ask for SCI-DRY™ (2 oz. - CASE) (RPI Part #SCA055)

NEW PART For **Tuttnauer®**

RPI Part #TUC094
OEM Part #CB0010 (Chamber Brite™)

TUTT-CLEAN™

- Sterilizer cleaner
- (1) Box of 10 packets

Models: Most Tuttnauer® autoclaves including 1730, 2340, 2540, 3850 & 3870 Series



• Also available by the case of 12 boxes!
Just ask for TUTT-CLEAN™ (CASE) (RPI Part #TUC095)

Table Top Sterilizers

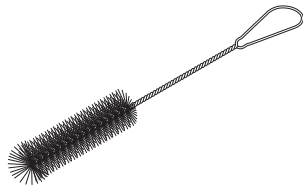

RPI Part #RPB792
OEM Part # (No OEM Part # Available)

LARGE DIA. BRUSH (1-3/4")

- Bristle size: 1-3/4" dia. x 4-1/2" lg.; Overall length: 11-1/2"
- Black bristle with radial tip
- Suggested uses: Water reservoirs, bellows housings, large port valve assemblies
- Also included in: Cleaning Kit (RPI Part #RPK791)



RPI Part #RPB793
OEM Part # (No OEM Part # Available)

SMALL DIA. BRUSH (3/8")

- Bristle size: 3/8" dia. x 2" lg. Overall length: 8"
- White bristle
- Suggested uses: Door bellows housing, solenoid valve bonnets and small valve housings
- Also included in: Cleaning Kit (RPI Part #RPK791)

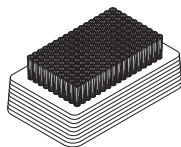

RPI Part #RPB794
OEM Part # (No OEM Part # Available)

SCRUB BRUSH

- Black Nylon® bristles. Block is laminated hardwood with clear lacquer finish
- Bristle size: 3/4"; Block size: 2-1/2" x 4-1/4"
- Suggested uses: Instrument trays and racks, cassettes, door covers, sterilizer casings, reservoir surface and sterilizer base platforms
- Also included in: Cleaning Kit (RPI Part #RPK791)



RPI Part #RPB795
OEM Part # (No OEM Part # Available)

HANDLE BRUSH

- Bristle size: 1/2" H x 1-3/4" lg.; Overall brush length: 6-5/8"
- Black Nylon® bristles
- Suggested uses: U-channels, V-channels, threads
- Also included in: Cleaning Kit (RPI Part #RPK791)

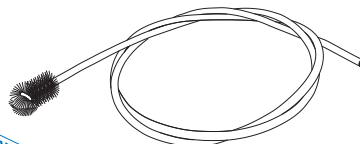

RPI Part #RPB796
OEM Part # (No OEM Part # Available)

FLEXIBLE TUBE BRUSH (7/8")

- Bristle size: 7/8" x 1-1/8" lg.; Overall length: 41"
- White Nylon® bristles
- Suggested uses: Condensers, manifolds, traps and valves
- Also included in: Cleaning Kit (RPI Part #RPK791)

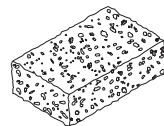

RPI Part #RPS797
OEM Part # (No OEM Part # Available)

SPONGE (4-1/4" x 6")

- 3 per package
- Cellulose sponge (1-5/8" thk.)
- 10 times more absorbent than polyurethane sponges
- Also included in: Cleaning Kit (RPI part #RPK791)

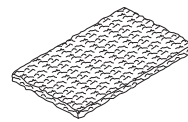

RPI Part #RPP798
OEM Part # (No OEM Part # Available)

CLEANSING PAD

- 3 per package
- Light duty cleansing pad made from non-woven fibers
- Size: 6" x 9"
- Ideal for: stainless steel, chrome, copper, porcelain and ceramic
- Also included in: Cleaning Kit (RPI Part #RPK791)

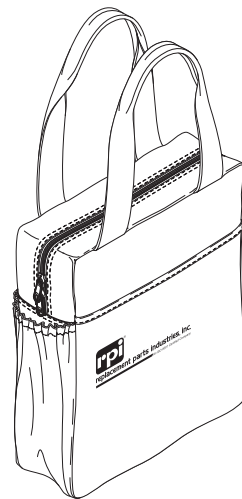

RPI Part #RPC799
OEM Part # (No OEM Part # Available)

CARRYING CASE

- Size: 13"H x 10"W x 3-1/2"D
- 3 brush compartments and large storage space
- 2 end pouches large enough to accommodate 16 oz. bottles
- Large front pocket
- Zipper closure

RPI Part #AMG004
OEM Part #P754874-091

DOOR GASKET

- 8.000" OD x .156" x .250" C/S

Fits: 8" Round Door
Model: Dynaclave 613R (576A)

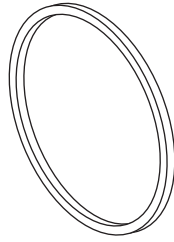

AMG004
CROSS SECTION
SHOWN ACTUAL SIZE

RPI Part #AMH016
OEM Part #P033165-061

HEATING ELEMENT ASSEMBLY

- 1400 W, 120 VAC, ~10Ω
- Includes all parts as shown
- Mounts inside chamber

Model: Dynaclave 613R (576A)

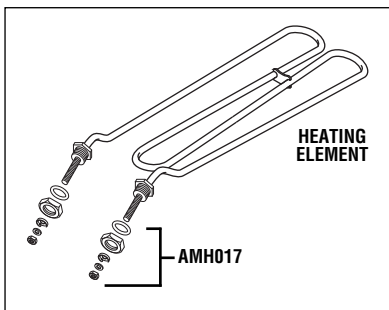

RPI Part #AMH017
OEM Part # (No OEM Part # Available)

MOUNTING & CONNECTING HARDWARE

- Includes (2) sets of parts shown
- Fits:** Heating Element Assembly (RPI Part #AMH016)

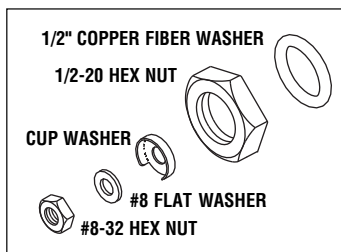

RPI Part #SPT004
OEM Part # (No OEM Part # Available)

DIAL THERMOMETER

- Reads: 60°F - 300°F/20°C - 130°C, 0-27 PSIG
- 1/4" MPT, 2" dia. dial face, 2" stem

Models:
Dynaclave 613R (576A)

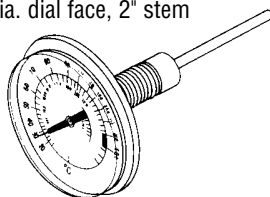

RPI Part #AMW065
OEM Part #P033169-091

FIBER WASHER

- 15 per package
- .335" ID x .620" OD x .030" thk
- Fits:** Special Bolt in Door Knob Assembly
- Model:** Dynaclave 613R (576A)



RPI Part #AMW066
OEM Part #P033229-041

WAVE WASHER

- 5 per package
- .315" ID x .500" OD x .101" thk
- Fits:** Special Bolt in Door Knob Assembly
- Model:** Dynaclave 613R (576A)



RPI Part #AMW067
OEM Part #M033231-041

FLAT WASHER

- 5 per package
- .200" ID x .625" OD x .032" thk
- Stainless steel
- Fits:** Special Bolt in Door Assembly
- Model:** Dynaclave 613R (576A)



RPI Part #AMW068
OEM Part #P026962-091

INTERNAL TOOTH WASHER

- 10 per package
- .260" ID x .562" OD x .025" thk
- Stainless steel
- Fits:** Special Pin in Door Assembly
- Model:** Dynaclave 613R (576A)



RPI Part #AMW069
OEM Part #P035161-091

TEFLON® WASHER

- .255" ID x .625" OD x .125" thk
- Fits:** Special Pin in Door Assembly
- Model:** Dynaclave 613R (576A)



RPI Part #AMP075
OEM Part #M033126-061

"SPECIAL" PIN

- Fits:** Door Knob Assembly
- Model:** Dynaclave 613R (576A)

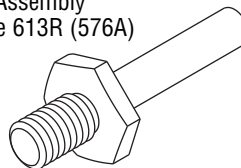

RPI Part #PCC004
OEM Part # (No OEM Part # Available)

POWER CORD WITHOUT CONNECTORS

- 8 ft.
- 16/3 conductor
- Type: HSJO (90°C heater cord)
- Fits:** Tabletop Sterilizers

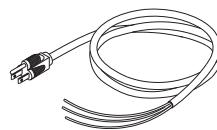

RPI Part #AMW070
OEM Part #P035163-091

TEFLON® WASHER

- .320" ID x .625" OD x .130" thk
- Fits:** Special Bolt in Door Assembly
- Model:** Dynaclave 613R (576A)



RPI Part #AMW071
OEM Part #M035162-091

CUP WASHER

- 5 per package
- .262" ID x .760" OD x .055" Deep
- Fits:** Special Pin in Door Assembly
- Model:** Dynaclave 613R (576A)



RPI Part #AMW072
OEM Part #M034847-061

CUP WASHER

- 5 per package
- .320" ID x .760" OD x .055" Deep
- Fits:** Special Bolt in Door Section
- Model:** Dynaclave 613R (576A)



RPI Part #AMW073
OEM Part #M033283-042

"D" SHAPED WASHER

- .760" ID x 1.145" OD x .068" thk
- Fits:** Special Bolt both sides of Door Hinge
- Model:** Dynaclave 613R (576A)

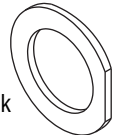

RPI Part #AMW074
OEM Part #P033124-061

CLUTCH WASHER

- Fits:** Special Bolt inside Door Knob Assembly
- Model:** Dynaclave 613R (576A)



RPI Part #AMN059
OEM Part #P034561-062

HEX NUT WITH ELASTIC STOP

- 5 per package
- 5/16-24
- Stainless steel
- Fits:** Door Knob Bolt
- Model:** Dynaclave 613R (576A)

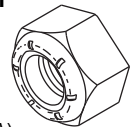

RPI Part #RPT113
OEM Part # (No OEM Part # Available)

MAX REGISTER THERMOMETER

- Mercury
- Length: 5-1/2"
- Accuracy Rating: ±1 Division (±2°F)
- Range: 150°F to 350°F
- Includes thermometer, and metal protective case

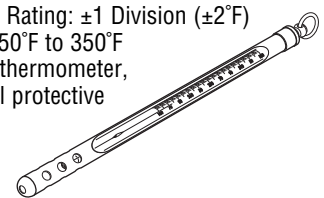

Table Top Sterilizers

Models: Dynaclave 613R (576A) (continued) and Models: 8816D & 8816M

RPI Part #AMG006
OEM Part #P074374-091

DOOR GASKET
• 11.000" OD x .375" x .250" C/S

Fits: 8" Square Door
Model: 8816D & 8816M

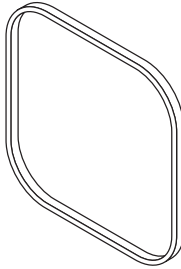

RPI Part #AML025
OEM Part #P041084-091

PILOT LIGHT
• Clear - "Thermostat On"
• 120 VAC
• Requires bulb (RPI Part #AMB028)
• Includes socket, lens, washer, nut, and (2) screw

Fits: Control Panel
Model: Dynaclave 613R (576A) & 8816M

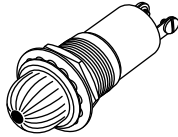

RPI Part #AML024
OEM Part #P041083-091

PILOT LIGHT
• Red - "Power On"
• 120 VAC
• Requires bulb (RPI Part #AMB028)
• Includes socket, lens, washer, nut, and (2) screw

Fits: Control Panel
Model: Dynaclave 613R (576A) & 8816M

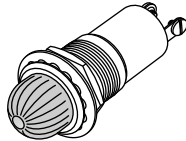

RPI Part #AMB028
OEM Part #764317-708

LIGHT BULB
• Standard NE51 bulb
• 120 VAC, 1/4 W
• T-3-1/4 mini bayonet
Fits: All Panel Light Sockets
Model: Dynaclave 613R (576A) & 8816M

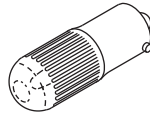

RPI Part #AMT037
OEM Part #P033149-091

THERMOSTAT CONTROL
• Range: 220°F - 350°F
Fits: Control Housing Assembly
Model: Dynaclave 613R (576A) & 8816M

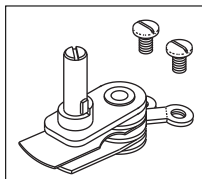

RPI Part #AMS035
OEM Part #P045325-091

ROCKER SWITCH
• DPDT
• 20 A @ 125 VAC
Fits: Front Control Panel
Model: 8816M

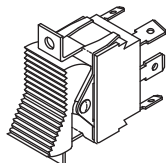

RPI Part #AMH018
OEM Part #P040894-091

HEATING ELEMENT ASSEMBLY
• 800 W, 120 VAC, ~18Ω
• Includes all parts as shown
• Mounts inside chamber
Model: 8816M

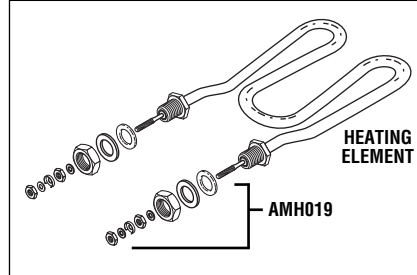

RPI Part #AMH019
OEM Part # (No OEM Part # Available)

MOUNTING & CONNECTING HARDWARE
• Includes (2) sets all parts as shown
Fits: Heating Element Assembly (RPI Part #AMH018) **Model:** 8816M

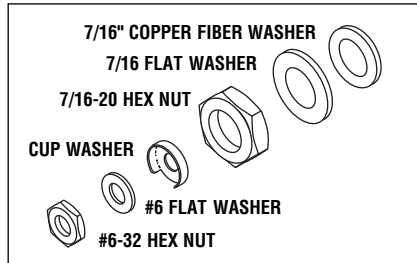

RPI Part #AMS038
OEM Part #M037103-091

TEFLON® VALVE SEAT
Fits: Control Housing
Model: Dynaclave 613R (576A) & 8816M



RPI Part #AMG011
OEM Part #P033153-091

CONTROL HOUSING GASKET
Fits: Main Control Housing
Model: Dynaclave 613R (576A) & 8816M (608A)

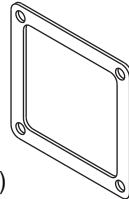

New RPI Part #RP0330
OEM Part #P033155-091
Industry Part #2-008

TEFLON® O-RING
• 6 per package
• .176" ID x .316" OD x .070" C/S
Fits: Control Housing and Steam Trap Assembly
Model: Dynaclave 613R (576A) & 8816M



RPI Part #AMT039
OEM Part #P033115-091

TIMER ASSEMBLY
• 60 minutes
• SPST
• Switch: 20 A, 240 VAC
• 1 HP @ 120 - 240 VAC
• Includes bell timer, face plate, knob, and mounting hardware
Fits: Front Control Panel
Model: Dynaclave 613R (576A) & 8816M

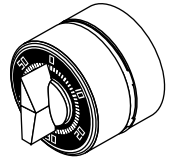

RPI Part #AMK022
OEM Part # (No OEM Part # Available)

OPERATING VALVE KIT
• Includes all parts as shown
Fits: Operating Valve Body
Model: Dynaclave 613R (576A) & 8816M

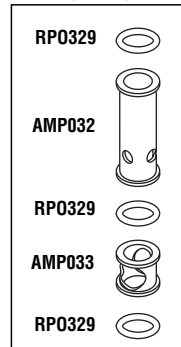

New RPI Part #RP0329
OEM Part #P033241-091
Industry Part #2-010

TEFLON® O-RING
• 6 per package
• .239" ID x .379" OD x .070" C/S
• Assembly requires three O-rings
Fits: Operating Valve
Model: Dynaclave 613R (576A) & 8816M



RPI Part #AMP032
OEM Part #P033240-091

UPPER PORT
Fits: Operating Valve
Model: Dynaclave 613R (576A) & 8816M

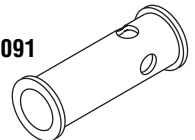

RPI Part #AMP033
OEM Part #P033239-091

LOWER PORT
Fits: Operating Valve
Model: Dynaclave 613R (576A) & 8816M



RPI Part #RPT113
OEM Part # (No OEM Part # Available)

MAX REGISTER THERMOMETER
• Mercury
• Length: 5-1/2"
• Accuracy Rating: ±1 Division (±2°F)
• Range: 150°F to 350°F
• Includes thermometer, and metal protective case



RPI Part #AMG006
OEM Part #P074374-091

DOOR GASKET

- 11.000" OD x .375" x .250" C/S
- Fits:** 8" Square Door
- Model:** 8816A

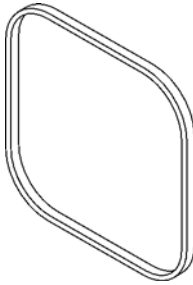

AMG006
CROSS SECTION
SHOWN ACTUAL SIZE

RPI Part #AMH018
OEM Part #P040894-091

HEATING ELEMENT ASSEMBLY

- 800 W, 120 VAC, ~18Ω
- Includes all parts as shown
- Mounts inside chamber
- Model:** 8816A

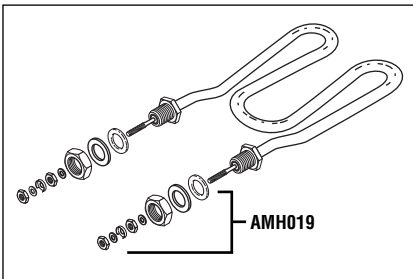

RPI Part #AMH019
OEM Part # (No OEM Part # Available)

MOUNTING & CONNECTING HARDWARE

- Includes (2) sets all parts as shown
- Fits:** Heating Element Assembly (RPI Part #AMH018)

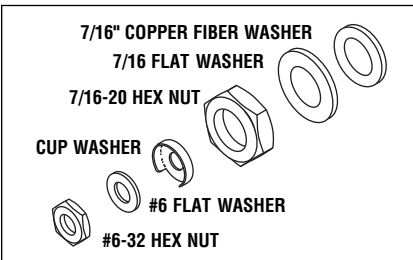

RPI Part #AMG034
OEM Part #P093077-001

PRESSURE/TEMPERATURE GAUGE

- Dual Scale: 212°F - 278°F, 0-60 PSIG
- Center back mount, 1/8" MPT
- 2-1/2" dia. dial
- 2-5/8" dia. panel cut-out
- Includes gauge, mounting bracket, and hardware

Fits: Front Panel
Model: 8816A

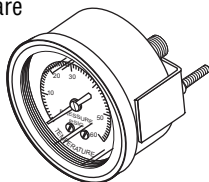

RPI Part #AMT003
OEM Part #P093073-001

THERMOSTAT SWITCH

- Range: 220°F - 350°F
- Includes controller, bulb, capillary tubes, and mounting hardware
- Controller mounts to control panel
- Model:** 8816A

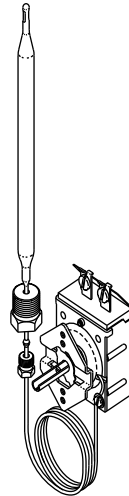

RPI Part #AMK022
OEM Part # (No OEM Part # Available)

OPERATING VALVE KIT

- Includes all parts as shown
- Fits:** Operating Valve Body
- Model:** 8816A

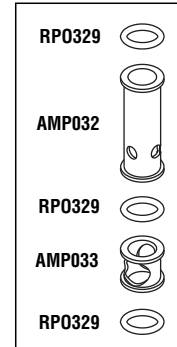

New RPI Part #RP0329
OEM Part #P033241-091
Industry Part #2-010



TEFLON® O-RING

- 6 per package
- .239" ID x .379" OD x .070" C/S
- Assembly requires three O-rings
- Fits:** Operating Valve
- Model:** 8816A

RPI Part #AMP032
OEM Part #P033240-091

UPPER PORT

- Fits:** Operating Valve
- Model:** 8816A

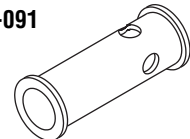

RPI Part #AMP033
OEM Part #P033239-091

LOWER PORT

- Fits:** Operating Valve
- Model:** 8816A



RPI Part #AMB028
OEM Part #764317-708

LIGHT BULB

- Standard NE51 bulb
- 120 VAC, 1/4 W
- T-3-1/4 mini bayonet
- Fits:** All Panel Light Sockets
- Model:** Dynaclave 613R (576A) & 8816M

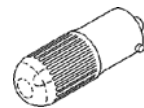

RPI Part #RPT113
OEM Part # (No OEM Part # Available)

MAX REGISTER THERMOMETER

- Mercury
- Length: 5-1/2"
- Accuracy Rating: ±1 Division (±2°F)
- Range: 150°F to 350°F
- Includes thermometer, and metal protective case

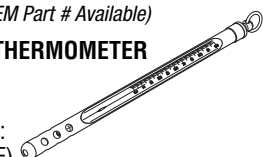

PARTS TO FIT THE STEAM TRAP

New RPI Part #RP0330
OEM Part #P033155-091
Industry Part #2-008



TEFLON® O-RING

- 6 per package
- .176" ID x .316" OD x .070" C/S
- Fits:** Control Housing and Steam Trap Assembly
- Model:** 8816A

RPI Part #AMH020
OEM Part #P150384-001

STEAM TRAP HEAD

- Fits:** Steam Trap Assembly
- Model:** 8816A

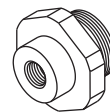

RPI Part #AMG013
OEM Part #P047003-091

FIBER GASKET

- 6 per package
- .875" ID x 1.250" OD x .065" thk
- Fits:** Steam Trap Assembly
- Model:** 8816A



RPI Part #AMG014
OEM Part #P454894-001

COPPER-FIBER GASKET

- .338" ID x .505" OD x .062" thk
- Fits:** Steam Trap Assembly
- Model:** 8816A

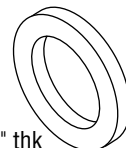

RPI Part #AMG095
OEM Part #P146653-007

DOOR GASKET

- ~10.250" OD
- Fits: Door
- Models: 900 & 901

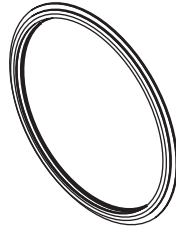

AMG095
CROSS SECTION
SHOWN ACTUAL SIZE

RPI Part #AMV104
OEM Part #P093902-452

SOLENOID VALVE COMPLETE

- 1/8" FPT; Piston style valve
- Material: Brass body, EPDM seal
- 2 way; N.C.
- 120VAC; 9.1W @ 60 Hz.
- Also available: Solenoid Valve Repair Kit (RPI Part #AMV105) and replacement Coil (RPI Part #AMC106)
- Models: 900 & 901

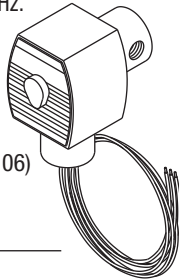

RPI Part #AMV105
OEM Part #P764320-920

SOLENOID VALVE REPAIR KIT

- Includes all parts as shown
- Also available: Solenoid Valve Complete (RPI Part #AMV104) and Coil (RPI Part #AMC106)
- Fits: Fill and Vent Solenoid Valves
- Models: 900 & 901

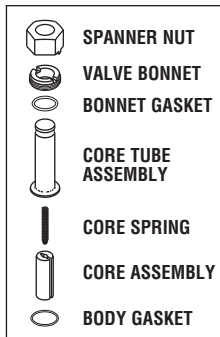

RPI Part #AMC106
OEM Part #P764316-149

COIL

- 120VAC; 9.1W @ 60 Hz.
- Also available: Solenoid Valve Complete (RPI Part #AMV104) and Solenoid Valve Repair Kit (RPI Part #AMV105)
- Fits: Fill and Vent Solenoids
- Models: 900 & 901

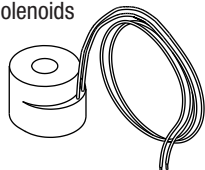

RPI Part #AMM093
OEM Part #P146653-021

TRIAC MODULE

- Mounts to inner wall
- Models: 900 & 901

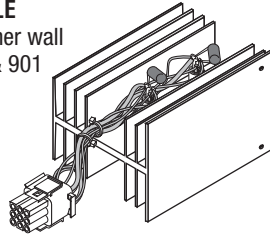

RPI Part #AMV097
OEM Part #P093902-453

SAFETY VALVE (38 PSI)

- Brass; 1/2" MPT x 1/2" FPT
- Cracking Pressure: 38 PSI
- Fits: Chamber
- Models: 900 & 901

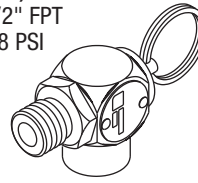

RPI Part #PCN136
OEM Part # (No OEM Part # Available)

SPEEDNUT

- 10 per package
- "U" type #10-24 thread



RPI Part #PCB134
OEM Part # (No OEM Part # Available)

ELECTRICAL TERMINAL BUSHING

- 3 per package
- 1/4" tabs
- Mounting hole: 11/16" dia.

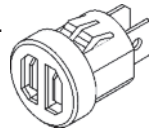

RPI Part #AMG091
OEM Part #P129357-660

PRESSURE GAUGE

- 0-60 PSI
- Center back mount, 1/8" MPT
- 1-1/2" dia. dial
- 1-9/16" dia. panel cut-out
- Includes all parts as shown
- Fits: Front Panel
- Models: 900 & 901

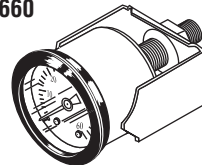

RPI Part #PCC004
OEM Part # (No OEM Part # Available)

POWER CORD WITHOUT CONNECTORS

- 8 ft.
- 16/3; 105°C
- 13A @125VAC
- Fits: Tabletop Sterilizers



RPI Part #AMT092
OEM Part #P764320-946

THERMISTOR KIT

- 24KΩ @ 77°F
- Includes all parts as shown
- Mounts in chamber
- Models: 900 & 901

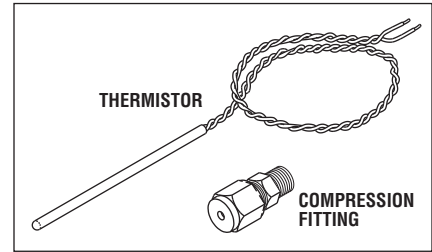

RPI Part #PCT042
OEM Part #P129357-647

OVERHEAT THERMOSTAT

- Factory set to open at 295°F
- Replaces old RPI Part #AMS098
- Models: 900 & 901

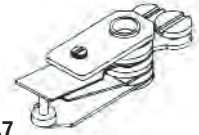

RPI Part #AMH096
OEM Part #P093902-461

HEATING ELEMENT

- 1500W, 120VAC, ~9Ω
- Mounts to chamber
- Includes hardware
- When replacing this part, it is also a good time to replace the Overheat Thermostat (RPI Part #PCT042)
- Models: 900 & 901

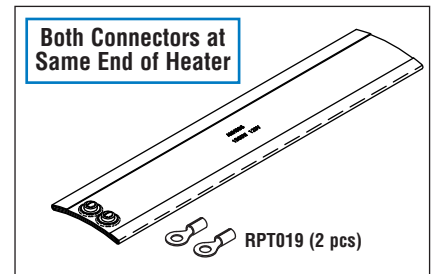

RPI Part #RPT113
OEM Part # (No OEM Part # Available)

MAX REGISTER THERMOMETER

- Mercury
- Size: ~.40" OD x ~6.63" lg.
- Accuracy Rating: ±1 Division (±2°F)
- Dual Scale: 150°F to 350°F/ 65°C to 177°C



- Includes: Metal Protective Case

Table Top Sterilizers

Models: Eagle® 10 & 10 Plus

RPI Part #AMK234
OEM Part #P426637-261 (Gasket Only)

STERILIZER PM KIT

- Includes all parts as shown plus a PM Check List & PM Sticker

Models: Eagle 10 & 10 Plus

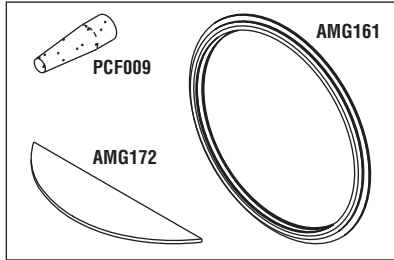

RPI Part #AMG161
OEM Part #P426637-261

DOOR GASKET (11")

- When replacing this gasket, it is also a good time to replace the Water Guard (RPI Part #AMG172)

Fits: Door
Models: Eagle 10 & 10 Plus

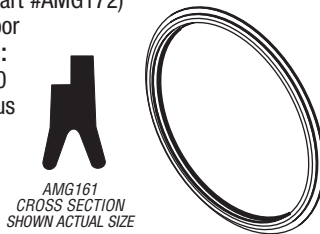

AMG161
 CROSS SECTION
 SHOWN ACTUAL SIZE

RPI Part #AMG172
OEM Part #P400027-717

WATER GUARD

- Just peel and stick for easy installation

Fits: Chamber
Models: Eagle 10 & 10 Plus



RPI Part #PCF009
OEM Part #P129357-645

FILTER - FILL LINE

- 120 - 150 micron

Fits: Fill Tube
Models: Eagle 10 & 10 Plus

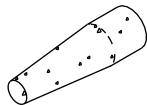

RPI Part #AMT165
OEM Part #P93910-915

FILL TUBE

- Material: 5/16" dia. brass tubing

Fits: Chamber and Fill Filter
Models: Eagle 10 & 10 Plus



RPI Part #AMV169
OEM Part #P418335-216

SAFETY VALVE (42 PSI)

- Material: Brass
- Cracking pressure: 42 PSI
- 1/2" MPT x 1/2" FPT
- Mounts to chamber

Models: Eagle 10 & 10 Plus

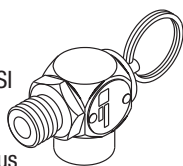

RPI Part #AMV170
OEM Part #P93910-910

SOLENOID ASSEMBLY VALVE-FILL/VENT

- 1/8" FPT;
- Piston style valve
- Brass body, EPDM seal
- 2 way; N.C.
- 120VAC; 9.1W @ 60 Hz.; 1/4" tabs
- Also available: Solenoid Valve Repair Kit (RPI Part #AMV105)

Fits: "T" & "L" fittings

Models: Eagle 10 & 10 Plus

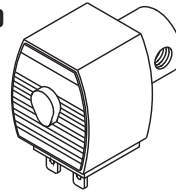

RPI Part #AMV105
OEM Part #P764320-920

SOLENOID VALVE REPAIR KIT

- Includes all parts as shown
- Also available: Solenoid Assembly Valve Fill/Vent (RPI Part #AMV170)

Fits: Fill and Vent Solenoid Valves

Models: Eagle 10 & 10 Plus

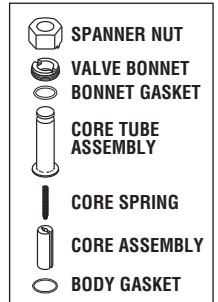

RPI Part #AMH162
OEM Part #P136807-855

HEATER ASSEMBLY

- 1500W, 120VAC, 9C
- Includes all parts as shown
- Mounts to bottom of chamber

Models: Eagle 10 & 10 Plus

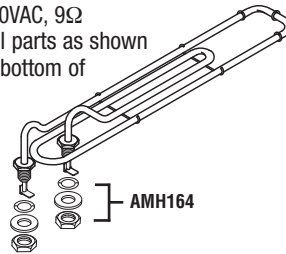

RPI Part #AMH164
OEM Part # (No OEM Part # Available)

HEATER MOUNTING HARDWARE

- Includes (2) sets of all parts as shown

Fits: Heating element (RPI Part #AMH162)

Models: Eagle 10 & 10 Plus

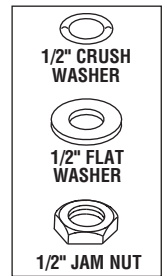

RPI Part #AMG163
OEM Part #P93910-142

PRESSURE GAUGE

- 0-60 PSI/0-410 KPa
- 1.500" dia. dial
- Center back mount - 1/8" MPT

Fits: Door assembly
Models: Eagle 10 & 10 Plus

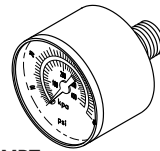

RPI Part #AMC167
OEM Part #P422922-153

CONDENSATION COIL WITH COMPRESSION FITTING

- 1/4" brass tubing

Fits: Reservoir Assembly
Models: Eagle 10 & 10 Plus



RPI Part #AMS179
OEM Part #P93910-148

DOOR SWITCH

- 15A @ 120VAC
- 4A @ 250VAC
- 3/16" tabs
- Mounts to door bracket assembly

Models: Eagle 10 & 10 Plus

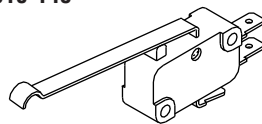

RPI Part #AMB168
OEM Part #P400009-085

AIR VENT BELLOWS

- 5/16" compression fittings-both ends

Fits: Mounts between chamber and reservoir tubing

Models: Eagle 10 & 10 Plus

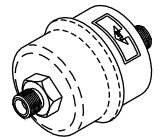

RPI Part #AMF166
OEM Part # (No OEM Part # Available)

FRONT-RUBBER FOOT ASSY

- Includes (2) sets of each part as shown
- Mounts to bottom front assy

Models: Eagle 10 & 10 Plus

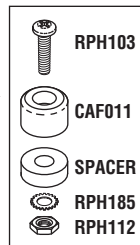

RPI Part #AMF180
OEM Part # (No OEM Part # Available)

REAR-RUBBER FOOT ASSY

- Includes (2) sets of each part as shown
- Mounts to bottom rear assy

Models: Eagle 10 & 10 Plus

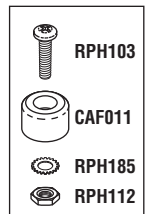

RPI Part #RPC262
OEM Part # (No OEM Part # Available)

INDUSTRIAL GRADE POWER CORD

- 14/3 SJT
- 15 A @ 125 VAC
- Length: ~10 ft.

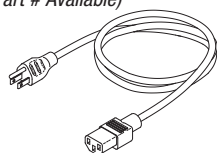

RPI Part #RPT113
OEM Part # (No OEM Part # Available)

MAX REGISTER THERMOMETER

- Mercury
- Size: ~.40" OD x ~6.63" lg.
- Dual Scale: 150°F to 350°F / 65°C to 177°C

• Includes: Metal Protective Case

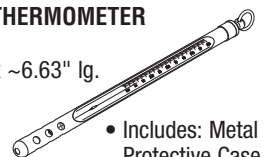

BEFORE ORDERING

Check If You Need
Ring Style or
Pancake Style Gasket.

RPI Part #RCG022
OEM Part #62308

DOOR GASKET

- 9.500" OD

Fits: Door
(ring style)

Model: 2250
& 2260



RPI Part #RCG071
OEM Part #69904

DOOR GASKET

- 8.625" OD
- Pancake style,
hole in center

Fits: Door
Model: 2250
& 2260

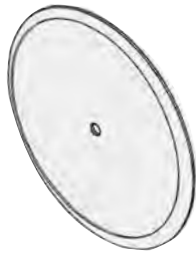

RPI Part #RCG023
OEM Part #62259

DOOR GASKET

- 11.500" OD

Fits: Door
(ring style)

Models: 2251



RPI Part #RCG073
OEM Part #68424

DOOR GASKET

- 10.500" OD
- Pancake style,
hole in center

Fits: Door
Models: 2251



RPI Part #RCT050
OEM Part #61854

MANUAL THERMOSTAT

- Opens @ 335°F, Closes @ 290°F

Fits: Chamber

Models: 2250, 2251
& 2260

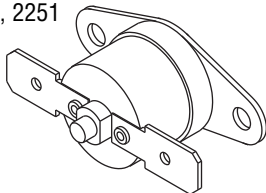

RPI Part #RCH027
OEM Part #63824

DUAL HEATING ELEMENT

- 1350 W, 120 VAC, ~10Ω;
- 100 W, ~144Ω

- Metal clad
- Mounts on outside of chamber

Models: 2250, 2251 & 2260

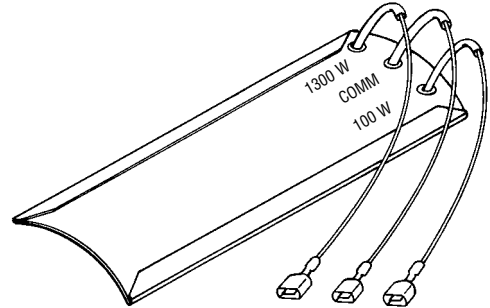

New RPI Part #RCL077
OEM Part #62299

HEATING LIGHT (AMBER)

- 120 VAC, 1/3 W
- Includes all parts in kit as shown

Fits: Control Panel
Models: 2250, 2251
& 2260

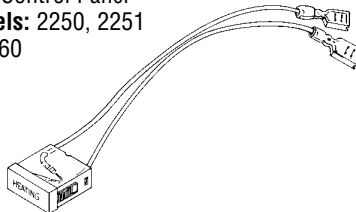

New RPI Part #RCL075
OEM Part #62300

DRYING LIGHT (AMBER)

- 120 VAC, 1/3 W
- Includes all parts in kit as shown

Fits: Control Panel
Models: 2250, 2251
& 2260

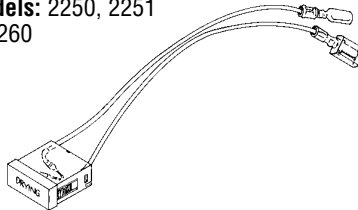

New RPI Part #RCL076
OEM Part #62298

TIMING LIGHT (RED)

- 120 VAC, 1/3 W
- Includes all parts in kit as shown

Fits: Control Panel
Models: 2250, 2251 & 2260

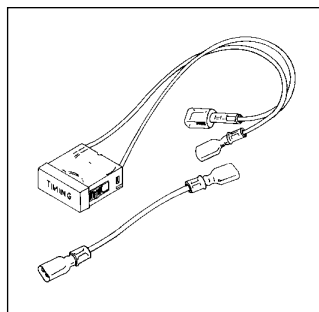

New RPI Part #RCR074
OEM Part #62313

CONTROL RELAY

- 15 A @ 120 VAC

Models: 2250

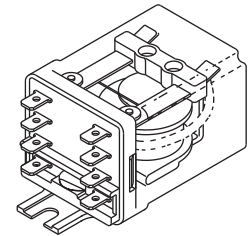

New RPI Part #RCR078
OEM Part #63688

TIME DELAY RELAY

- 15 A @ 120 VAC
- Heat Time: 20-70 seconds; Cool Time:
50-80 seconds

• Mounts to bottom plate
Models: 2250, 2251
& 2260

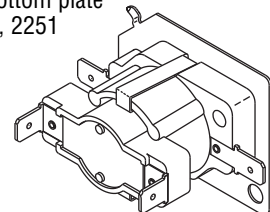

RPI Part #RCI028

OEM Part # (No OEM Part # Available)

INSULATION

- 4" x 12" x 1/8" thk
 - Mica heaters only
- Fits:** Mica Heater (Non-Metal Clad)
Models: 2250, 2251 & 2260

**Do Not Use With
Dual Heating Element
(RPI Part #RCH027)**

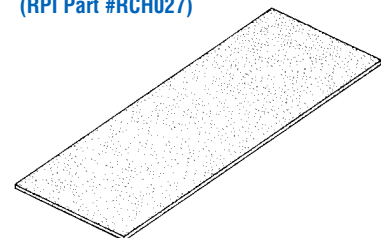

RPI Part #MDG001
OEM Part #250007801

DOOR GASKET
• 6.500" OD x .187" dia. C/S

Fits: Chamber
Models: Aquaclave 10; Chemiclave E, 4000 & 5000

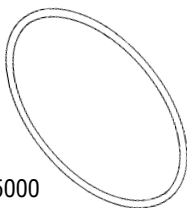

RPI Part #MDG002
OEM Part #204004801

DOOR GASKET
• 5.000" OD x .125" C/S

Fits: Chamber
Model: Chemiclave D

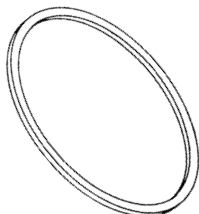

RPI Part #MDG013
OEM Part #280000301

DOOR GASKET
• 8.500" OD x .210" dia. C/S

Fits: Chamber
Models: Aquaclave 20; Chemiclave 5500 & 7000

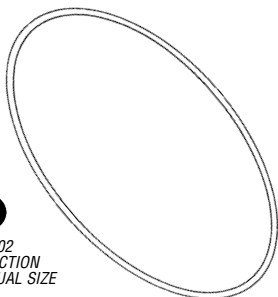

RPI Part #MDG003
OEM Part #260006701

DOOR GASKET (QUAD RING)
• 11.000" OD x .312" Sq. C/S

Fits: Chamber
Models: Aquaclave 30; Chemiclave 6000 & 8000

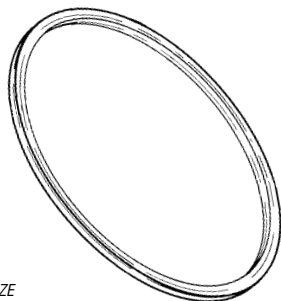

RPI Part #MDL019
OEM Part #250056901

RED INDICATOR LIGHT (SOLUTION)

• 125 VAC, 1/3 W
Fits: Control Panel
Models: Aquaclave 10, 20 & 30; Chemiclave 5000, 5500 & 6000

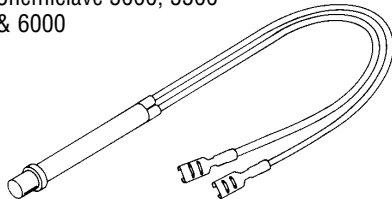

RPI Part #MDL020
OEM Part #250056911

WHITE INDICATOR LIGHT (POWER)

• 125 VAC, 1/3 W
Fits: Control Panel
Models: Chemiclave 5000, 5500 & 6000

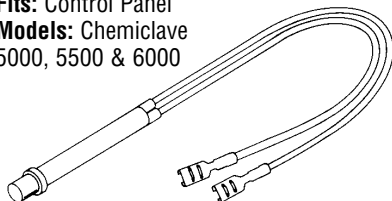

RPI Part #MDL021
OEM Part #250056921

AMBER INDICATOR LIGHT (TEMPERATURE)

• 125 VAC, 1/3 W
Fits: Control Panel
Models: Chemiclave E, 4000, 5000, 5500 & 6000

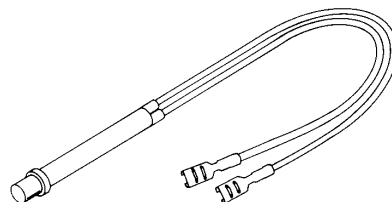

RPI Part #MDL022
OEM Part #250056931

GREEN INDICATOR LIGHT (STERILE)

• 125 VAC, 1/3 W
Fits: Control Panel
Models: Aquaclave 10, 20 & 30; Chemiclave 5000, 5500 & 6000

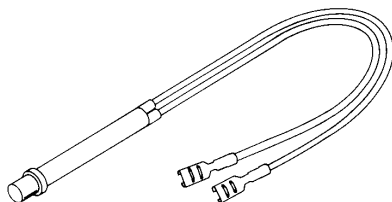

RPI Part #MDT025
New OEM Part #250065701

ELECTRICAL TIMER ASSEMBLY

• 20 minute timer; Buzzer
• Mount: 3/8-32 x 1/2" lg. Bushing
• Shaft size: 1/4" dia. x 9/16" lg. Double Flat
• Dimensions: 3-1/8" x 3-1/2" x 2-5/8" DP.
• See RPI website for motor and switch specs
Fits: Control Panel

Models:
Chemiclave 5000, 5500 & 6000

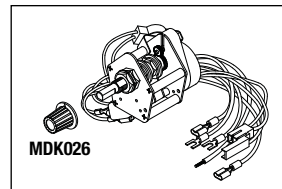

RPI Part #MDT012
New OEM Part #250007503
Old OEM Part #D82A

TIMER WITH BELL

• 60 minute timer; Bell
• Mount: 3/8-24 x 1.0" lg. Bushing
• Shaft size: 3/16" dia. x 9/16" lg. Double Flat
• Dimensions: 2-11/16" dia. x 1-1/4" DP.

• Includes all parts as shown

Fits: Control Panel
Models: Chemiclave D, E & 4000

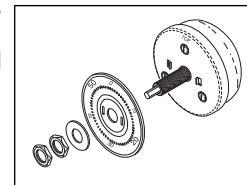

RPI Part #MDS005
OEM Part #204004101

SWITCH ASSEMBLY

• SPST
• 20 A @ 125 VAC; 1 HP @ 250 VAC
• Includes all parts as shown

Fits: Control Panel
Model: Chemiclave D

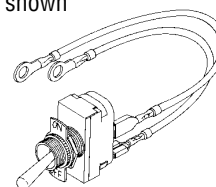

RPI Part #MDS017
New OEM Part #260062401
Old OEM Part #266846

FLOAT SWITCH

• Includes all parts as shown
Fits: Reservoir Assembly

Models: Aquaclave 10, 20 & 30; Chemiclave 4000, 5000, 5500 & 6000

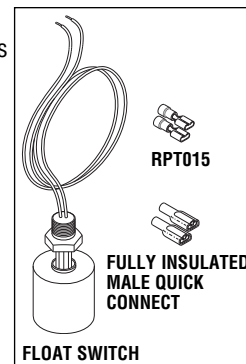
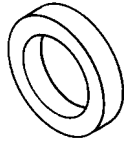

Table Top Sterilizers

Models: Aquaclave 10, 20, 30; Chemiclave D, E, 4000, 5000, 5500, 6000, 7000 & 8000 (continued)

RPI Part #MDG008
OEM Part # (No OEM Part # Available)

PHENOLIC GASKET
 • 6 per package
 Fits: Pressure Release Filler Cap
 Model: Chemiclave D



RPI Part #MDK004
OEM Part #204005701

VALVE PACKING KIT
 • Includes all parts as shown
 Fits: Valve Stem
 Model: Chemiclave D

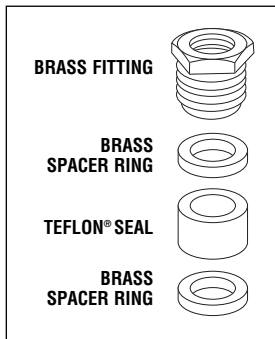

RPI Part #MDV007
OEM Part #D14A

VALVE STEM ASSEMBLY
 • Includes all parts as shown
 Fits: Reservoir Assembly
 Model: Chemiclave D

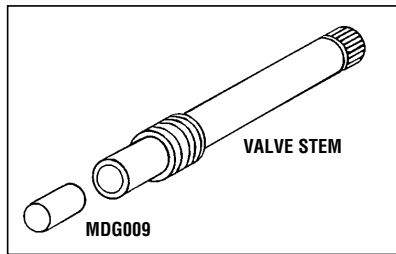

FOR SERVICE TIPS, AND OTHER TECH INFO, VISIT THE RPI WEBSITE: rpiparts.com

RPI Part #MDH015
OEM Part #D18

HANDLE ASSEMBLY
 Fits: Valve Stem
 Model: Chemiclave D

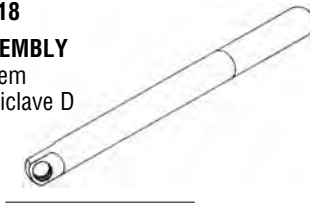

RPI Part #MDH014
OEM Part #D32

DOOR HANDLE
 Fits: Door Assembly
 Model: Chemiclave D

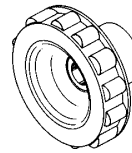

RPI Part #MDK026
OEM Part #260062000

TIMER KNOB
 Fits: Timer
 Models: Aquaclave 10, 20 & 30; Chemiclave 5000, 5500 & 6000

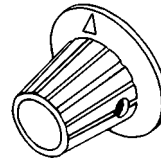

RPI Part #PCC004
OEM Part # (No OEM Part # Available)

POWER CORD WITHOUT CONNECTORS
 • 8 ft.
 • 16/3 conductor
 • Type: HSJO (90°C heater cord)
 Fits: Tabletop Sterilizers

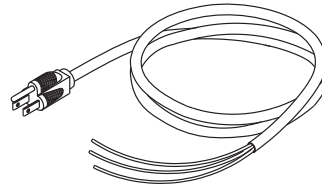

RPI Part #MDK018
OEM Part #260007301

CONTROL KNOB
 Fits: Valve Shaft
 Models: Aquaclave 10, 20 & 30; Chemiclave E, 4000, 5000 & 5500

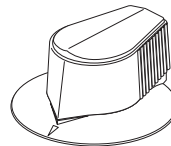

RPI Part #MDG009
OEM Part # (No OEM Part # Available)

BAKELITE GASKET (SEAT)
 • 6 per package
 Fits: Valve Stem
 Model: Chemiclave D

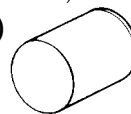

RPI Part #RPA032
THREADLOCKER 242

• 5 per package
 • .02 fl. oz. per tube
 • Prevents rust and corrosion
 • Removable adhesive by Loctite®

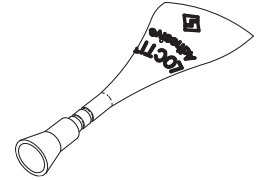

New RPI Part #RP0303
Industry Part #2-012

O-RING - DRAIN SPOUT
 • 12 per package
 • Material: Buna-N (Nitrile)
 • Hardness: 70 Duro
 • .364" ID x .504" OD x .070" C/S
 • Also included in O-Ring Kits (RPI Part #RPK403 and RPK404)
 Model: 5000, 5500 & 6000

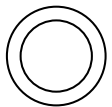

DON'T FORGET!

RPI Part #RPL090
HIGH TEMP LUBRICANT

• 5 per package
 • 1/2 gram each package
 • For Non-silicone use only. Do not use with highly oxidative chemicals (e.g. liquid chlorine, liquid oxygen, etc.).
 • Temperature range: -40°F to +40°F
 • Used on pluge valves, pump packaging, gate valves, butterfly valves, sanitary valves, rubber and plastic o-rings, stems and piston



RPI Part RPT113
OEM Part # (No OEM Part # Available)

MAX REGISTER THERMOMETER

• Mercury
 • Length: 5-1/2"
 • Accuracy Rating: ±2 Div.
 • Range: 150°F to 350°F
 • Includes thermometer, and metal protective case

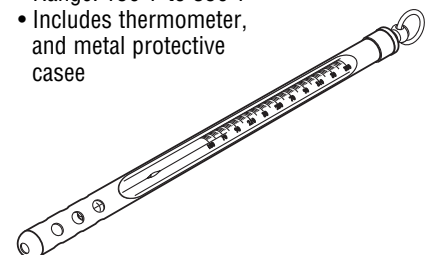

THE RPI ADVANTAGE!

The RPI Metering Valves are PMable!

If RPI valve begins to show signs of needing service, simply replace the O-rings. RPI Metering Valves come with a FREE lifetime supply of the Metering Valve Service Kits (RPI Part #MDK057). Your first PM Service Kit is included with the valve. Then when you need another, just contact RPI to request your FREE Metering Valve Service Kit.

The RPI Metering Valves are PMable! Simply replace worn O-rings with the FREE Metering Valve Service Kit.

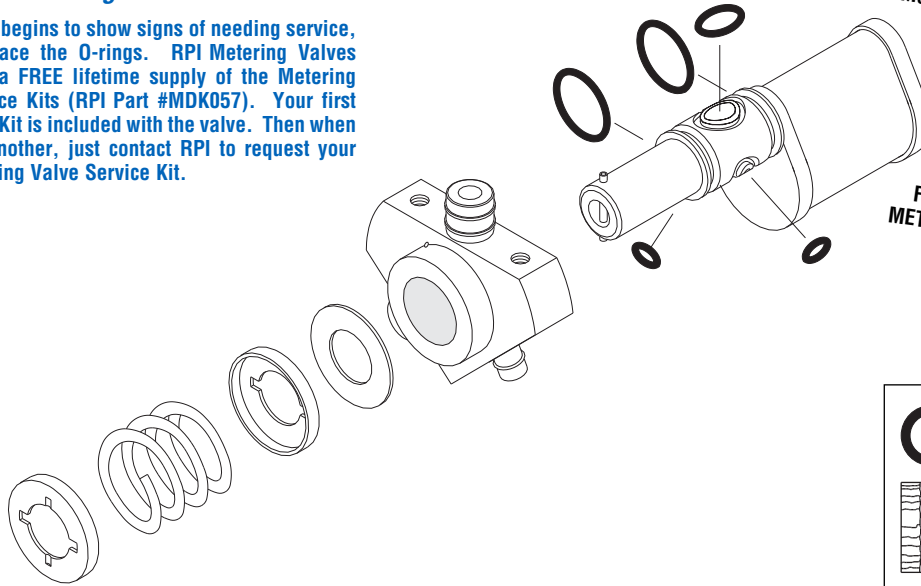

Free lifetime supply of the METERING VALVE SERVICE KIT RPI Part #MDK057

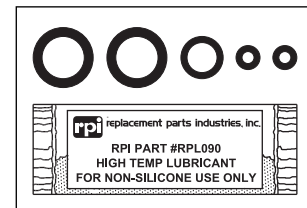

RPI Part #MDS058

OEM Part # (No OEM Part # Available)

SPLASH SHIELD

Fits: Only RPI Metering Valves (RPI Part #MDV010, MDV011 & MDV016)

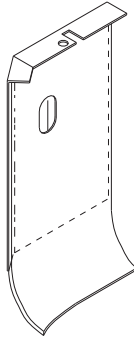

RPI Part #MDK057

OEM Part # (No OEM Part # Available)

SERVICE KIT

Includes (5) O-rings, and (1) package of High Temp Lubricant (RPI Part #RPL090)

Fits: Only RPI Metering Valves (RPI Part #MDV010, MDV011 & MDV016)

FREE LIFETIME AVAILABILITY
Metering Valve Service Kit
The Metering Valve Service Kit (RPI Part #MDK057) comes with a FREE Lifetime Availability with the purchase of the RPI metering valve.

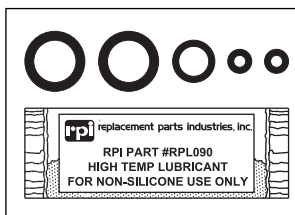

RPI Part #MDV010

OEM Part #2-50-0011-03

RPI METERING VALVE

- Includes all parts as shown
- FREE Service Kits (RPI Part #MDK057) are available for the lifetime of the RPI metering valve

Fits: Chamber
Models: E, 4000 & 5000

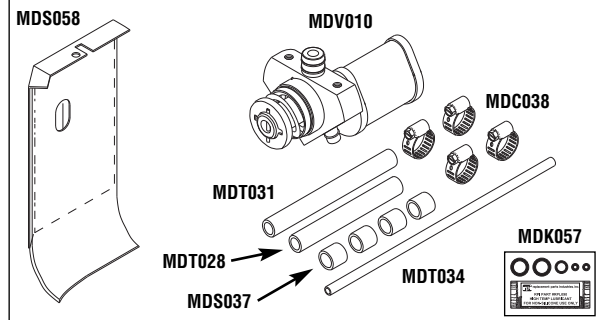

RPI Part #MDV011

OEM Part #2-80-0027-02

RPI METERING VALVE

- Includes all parts as shown
- FREE Service Kits (RPI Part #MDK057) are available for the lifetime of the RPI metering valve

Fits: Chamber
Models: All 5500 Series

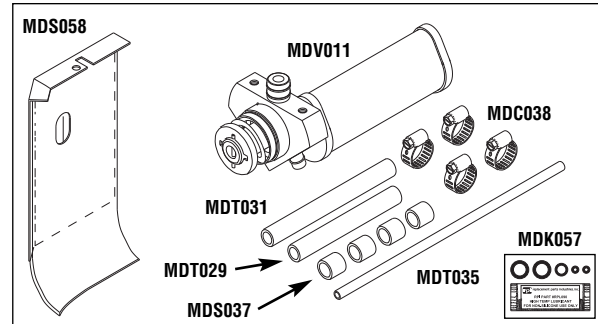

RPI Part #MDV016

OEM Part #2-60-0633-03

RPI METERING VALVE

- Includes all parts as shown
- FREE Service Kits (RPI Part #MDK057) are available for the lifetime of the RPI metering valve

Fits: Chamber
Models: All 6000 Series

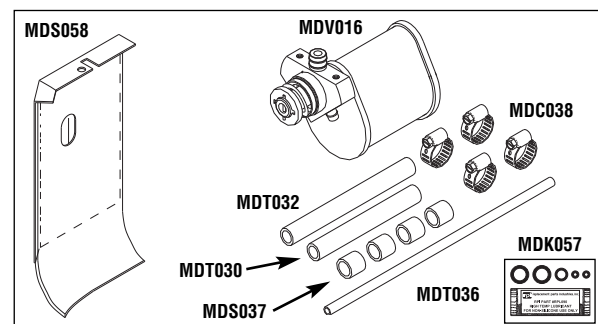

Table Top Sterilizers

Models: Aquaclave 10, 20, 30; Chemiclave D, E, 4000, 5000, 5500, 6000, 7000 & 8000

RPI Part #RPH285
OEM Part # (No OEM Part # Available)

DRAIN HOSE

- Sold by the foot
- 3/8" ID x 5/8" OD x 1/8" Wall
- Reel Not Included
- Clear PVC

Fits: Drain Port
Models: All MDT

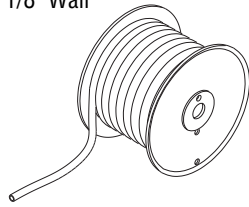

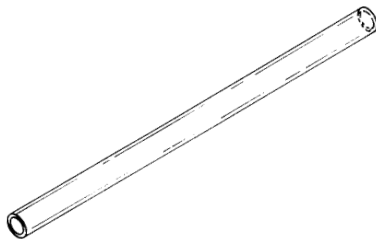

RPI Part #MDT028
New OEM Part #260008501
Old OEM Part #250008501

TEFLON® TUBE

- 3/8" ID x 2-1/4" lg.
- Reservoir to Valve

Models: Chemiclave E, 4000 & 5000

RPI Part #MDT029
OEM Part #250085201

TEFLON® TUBE

- 3/8" ID x 2-3/4" lg.
- Reservoir to Valve

Model: Chemiclave 5500

RPI Part #MDT030
OEM Part #250085301

TEFLON® TUBE

- 3/8" ID x 3" lg.
- Reservoir to Valve

Model: Chemiclave 6000

RPI Part #MDT031
OEM Part #25008601

TEFLON® TUBE

- 3/8" ID x 4-3/8" lg.
- Valve to Chamber

Models: Chemiclave E, 4000, 5000 & 5500

RPI Part #MDT032
OEM Part #250008611

TEFLON® TUBE

- 3/8" ID x 6" lg.
- Valve to Chamber

Model: Chemiclave 6000

RPI Part #MDT033
New OEM Part #250008701
Old OEM Part #E-87

TEFLON® TUBE

- 3/16" ID x 12" lg.
- Valve to Coils

Models: Chemiclave E & 4000

RPI Part #MDT034
OEM Part #250008711

TEFLON® TUBE

- 3/16" ID x 24" lg.
- Valve to Coils

Model: Chemiclave 5000

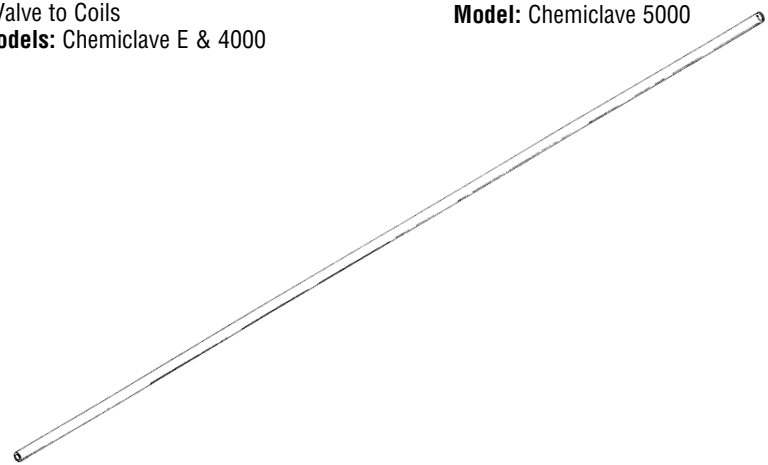

RPI Part #MDT035
OEM Part #260008701

TEFLON® TUBE

- 3/16" ID x 29" lg.
- Valve to Coils

Model: Chemiclave 5500

RPI Part #MDT036
OEM Part #260062110

TEFLON® TUBE

- 1/4" ID x 24" lg.
- Valve to Coils

Model: Chemiclave 6000

RPI Part #MDC038
New OEM Part #260026
Old OEM Part #250008801

SMALL HOSE CLAMP

- 2 per package
- Used with Red Silicone Sleeving and TFE Tubing

Fits: 3/8" Teflon® Tube

Models: Aquaclave 10, 20 & 30; Chemiclave E, 4000, 5000, 5500, 6000 & 7000

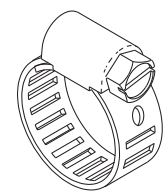

RPI Part #MDS037
OEM Part #260010801

RED SILICONE SLEEVING

- 2 per package

Fits: 3/8" Teflon® Tube

Models: Aquaclave 10, 20 & 30; Chemiclave E, 4000, 5000, 5500, 6000 & 7000

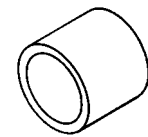

NOTES: _____

BEFORE ORDERING

Check If You Need

Ring Style or
Pancake Style Gasket.

RPI Part #RCG022
OEM Part
#2-62308

DOOR GASKET

• 9.500" OD

Fits: Door
(ring style)

Model: 800 & 800V

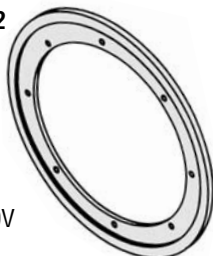

RPI Part #RCG071
OEM Part
#2-60952

DOOR GASKET

• 8.625" OD

• Pancake style,
hole in center

Fits: Door

Model: 800 & 800V

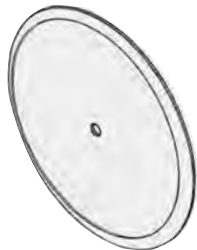

RPI Part #RCG023
OEM Part
#2-62259

DOOR GASKET

• 11.500" OD

Fits: Door
(ring style)

Models: 1000 & 1000R

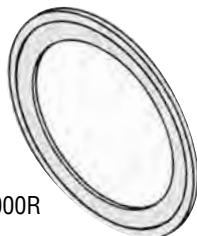

RPI Part #RCG073
OEM Part #2-68424

DOOR GASKET

• 10.500" OD

• Pancake style,
hole in center

Fits: Door

Models:
1000 & 1000R



RPI Part #RCG021
OEM Part #52217

DOOR GASKET

• 9.500" OD

• Pancake style

Fits: Door

Models: 1200 & 1250



RPI Part #RCH027
New OEM Part #260332
Old OEM Part #63824

DUAL HEATING ELEMENT

• 1350 W, 120 VAC, ~10Ω;

100 W, ~144Ω

• Sheathing: Electrogalvanized Sheet Steel

• Mounts on outside of chamber

Models: GLS8, GLS10, 800, 800V,
1000 & 1000R

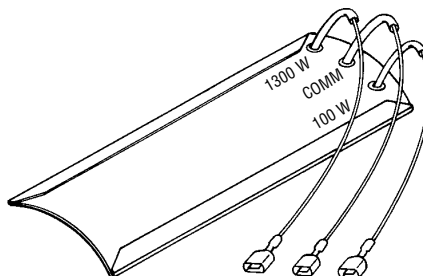

RPI Part #RCT050
OEM Part #61854

MANUAL THERMOSTAT

• Opens @ 335°F, Closes @ 290°F

Models: 800, 800V, 1000 & 1000R

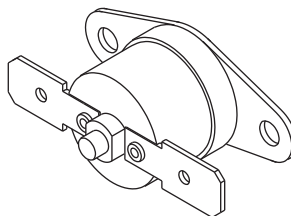

RPI Part #RCI028
OEM Part #63403

INSULATION

• 4" x 12" x 1/8" thk

• Do not use with metal clad heaters

Fits: Mica Heater (Non-Metal Clad)

Models: 800, 800V, 1000 & 1000R

**Do Not Use With
Dual Heating Element**
(RPI Parts #RCH026 & #RCH027)

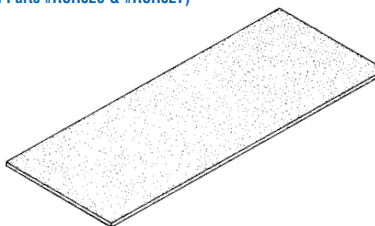

RPI Part #RCH026
OEM Part #40266

DUAL HEATING ELEMENT

• 1350W, 120VAC, ~10Ω; 100W, ~144Ω

• Sheathing: Electrogalvanized Sheet Steel

• Mounts on outside of chamber

Models: 1200 & 1250

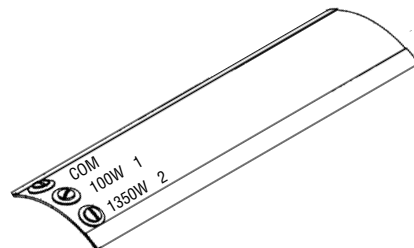

RPI Part #RCL030
OEM Part #40319

"READY" LAMP

• 120 VAC, 1/3 W

Fits: Control Panel

Models: 1200 & 1250

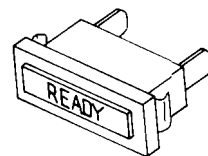

RPI Part #RCL031
OEM Part #40272

"STERILIZING" LAMP

• 120 VAC, 1/3 W

Fits: Control Panel

Models: 1200 & 1250

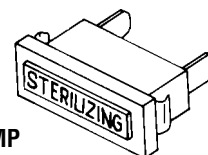

RPI Part #RCL032
OEM Part #46051

"COOLING" LAMP

• 120 VAC, 1/3 W

Fits: Control Panel

Model: 1250

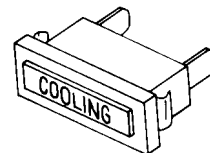

RPI Part #RCT049
OEM Part #46049

TIME SWITCH

• 60 minute electric timer

• SPST

• 15 A @ 120 VAC, 60 Hz

• Includes timer, mounting

nut, and push-on

connector

Fits: Control Panel

Model: 1250

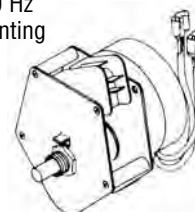
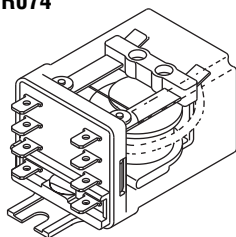

Table Top Sterilizers

Models: GLS8, GLS10, 800, 800V, 1000, 1000R, 1200 & 1250 (continued)

New RPI Part #RCR074
OEM Part #62313

CONTROL RELAY
 • 15 A @ 120 VAC
Models: 800



New RPI Part #RCR078
OEM Part #63688

TIME DELAY RELAY
 • 15 A @ 120 VAC
 • Heat Time: 20–70 seconds;
 Cool Time: 50–80 seconds
 • Mounts to bottom plate
Models: 800V, 1000 & 1000R

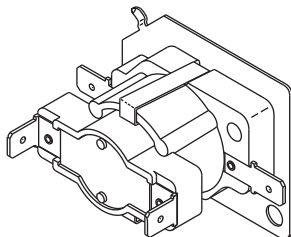

New RPI Part #RCL075
OEM Part #69827/62300

DRYING LIGHT (AMBER)
 • 120 VAC, 1/3 W
 • Includes all parts as shown
Models: 800, 800V, 1000 & 1000R

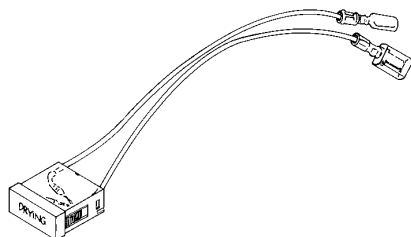

New RPI Part #RCL077
OEM Part #69831/62299

HEATING LIGHT (AMBER)
 • 120 VAC, 1/3 W
 • Includes all parts as shown
Models: 800, 800V, 1000 & 1000R

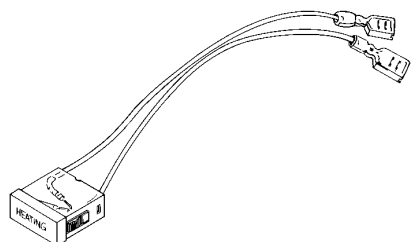

New RPI Part #RCL076
OEM Part #69829/62298

TIMING LIGHT (RED)
 • 120 VAC, 1/3 W
 • Includes all parts as shown
Models: 800, 800V, 1000 & 1000R

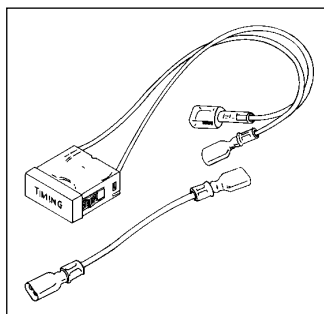

New RPI Part #RCV080
OEM Part #68725 & 62296

WATER FILL VALVE
 • Includes all parts as shown
 • 1/8 FPT ports
 • Momentary, 2 way N.C
Models: 800, 800V, 1000 & 1000R

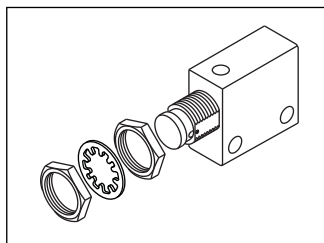

New RPI Part #RCV081
OEM Part #62903

VENT CONTROL VALVE
Models: 1000R

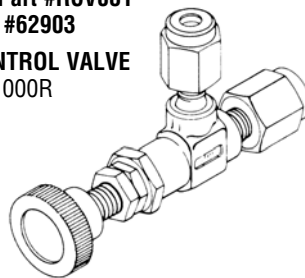

RPI Part #RCV082
OEM Part #64746

SAFETY RELIEF VALVE
 • Cracking pressure: 45 PSI
 • 1/2" FPT x 1/2" MPT
Models: 800, 800V, 1000, 1000R & 1200

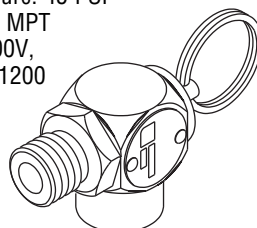

New RPI Part #RCG083
OEM Part #64414

PRESSURE GAUGE
 • 5/8" x 1-3/4" panel cut-out
 • Reads 0-60 PSIG
 • Accommodates 1/8" and 3/16" tubing
 • Includes gauge, mounting bracket, mounting hardware, and compression fittings
Models: 800, 800V, 1000 & 1000R

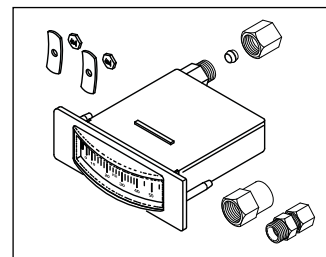

New RPI Part #RCT084
OEM Part #69951

STEAM TRAP
 • 1/2" MPT x 1/2" FPT
Models: 800, 800V, 1000 & 1000R

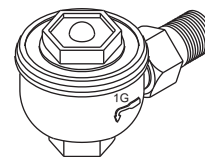

RPI Part #RCB002
OEM Part # (No OEM Part # Available)

BELLOWS ASSEMBLY
 • Includes bellows, and compression fitting
 • Mounts in reservoir
Model: 800V's with 3/16" tubing, 1200 & 1250

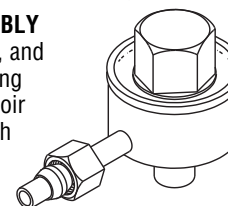

New RPI Part #RCK079
OEM Part #46062

CONTROL KNOB
Models: 800V, 1000 & 1000R

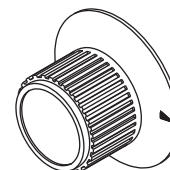

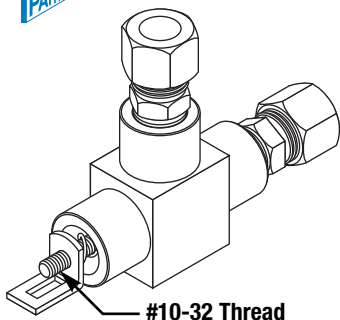

RPI Part #RCV052
OEM Part #H98136 & 36906

FILL VENT VALVE

- Material: Brass body; EP seals
 - Includes (x2) 3/8" male connector fittings and "L" Bracket
 - Also available, Valve Stem Kit (RPI Part #RCS098), O-Ring (RPI Part #RPO306) and O-Ring (RPI Part #RPO307)
- Fits:** Fill-Vent bracket assembly
Models: 1200 & 1250

Service Tip

The Valve Stem Kit (RPI Part #RCS097) fits the Fill Vent Valve with **(2) of the same sized O-Rings (RPI Part #RPO306) and 1/4-28 Thread.**

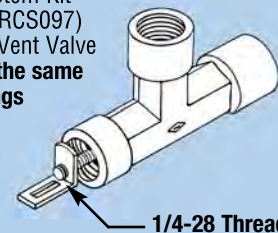

RPI Part #RCS097
OEM Part # (No OEM Part # Available)

VALVE STEM KIT

- Includes all parts as shown
- Fits:** Fill-Vent Valve **with (2) of the same sized O-rings (RPI Part #RPO306) and 1/4-28 Thread**
Models: 1200 & 1250

See Service Tip above.

STEM

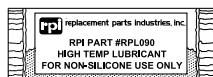
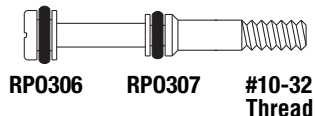

RPL090 (x1)

RPI Part #RCS098
OEM Part #002-0247-00

VALVE STEM KIT

- Includes all parts as shown
- Fits:** Original OEM and RPI Fill-Vent Valve (RPI Part #RCV052) **with (2) different sized O-rings (RPI Part #RPO306) & (RPI Part # RPO307) and #10-32 Thread**
Models: 1200 & 1250

STEM

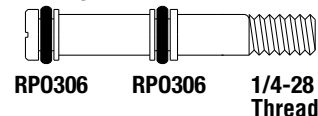

RPL090 (x1)

Service Tip

- If the stem has **(2) of the same sized o-rings**, then you need **(2) RPI Part #RPO306**.
- If the stem has **(2) different sized o-rings**, then you need **(1) RPI Part #RPO306** and **(1) RPI Part #RPO307**.

RPI Part #RPO306
OEM Part #H98136 & 36906
Industry Part #2-008



O-RING

- 12 per package;
 - Material: EPDM; Hardness: 70 Duro
 - .176" ID x .316" OD x .070" C/S
- Fits:** Fill Vent Valve
Models: 1200 & 1250

RPI Part #RPO307
OEM Part #H98138 & 146180
Industry Part #2-006



O-RING

- 12 per package;
 - Material: EPDM; Hardness: 70 Duro
 - .114" ID x .254" OD x .070" C/S
- Fits:** Fill Vent Valve
Models: 1200 & 1250

RPI Part #RPL090
OEM Part # (No OEM Part # Available)

HIGH TEMP LUBRICANT

- 5 per package
 - 1/2 gram each package
 - For Non-silicone use only. Do not use with highly oxidative chemicals (e.g. liquid chlorine, liquid oxygen, etc.).
 - Temperature range: -40°F to +40°F
- Fits:** Fill-Vent bracket assembly
Models: 1200 & 1250

DON'T FORGET THE HIGH TEMP LUBRICANT WHEN REPLACING O-RINGS



Visit the RPI website www.rpiparts.com for Service Tips, Tech Talk help, and much more

Now you have a choice...It's the RPI Advantage!

RPI offers two different Air Vent Bellows Assemblies – RPI Part #RCB089 and RCB100. There are two different styles of assemblies – the diaphragm style and the bellows style. Here's the difference.

The **RPI RCB089 and the OEM's are both diaphragm style assemblies.** This style has only one convolution doing all the work (by expanding and contracting).

The other style is a **bellows assembly – the RPI RCB100.** This style assembly, offered only by RPI, has several convolutions doing all of the work so it lasts much longer than the diaphragm style.

The Diaphragm Style Assembly or The Bellows Style Assembly!

RPI Part #RCB089
OEM Part #002-0375-00 & 014-0193-00

AIR VENT BELLOWS ASSEMBLY

- 1/4" compression fittings-both ends
- Bronze diaphragm;
- Stainless steel housing
- Actuates within 12°F of saturated steam temp.

Fits: Reservoir Tubing
Models: Newer 7's & M7

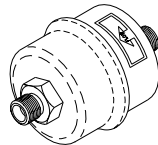

RPI Part #RCB100
OEM Part #002-0375-00 & 014-0193-00

AIR VENT BELLOWS ASSEMBLY

- 1/4" compression fittings-both ends
- Bronze bellows;
- Stainless steel housing
- Actuates within 5°F of saturated steam temp.

Fits: Reservoir Tubing
Models: Newer 7's & M7

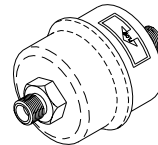

RPI Part #RCK123
OEM Part #002-0272-00

AIR VENT BELLOWS KIT

- This Kit replaces the Bellows Assembly (RPI Part #RCB002) which is no longer available.

- Includes all parts as shown

Models:
7 & M7

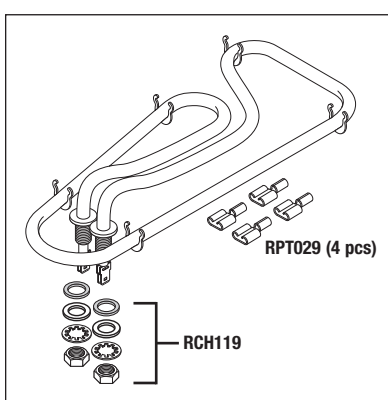
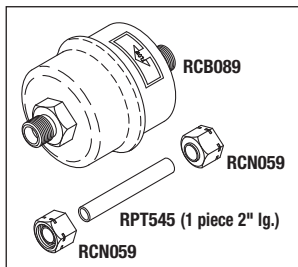

RPI Part #RCS042
OEM Part #002-0263-00 & 33053

RELAY SWITCH ASSEMBLY

- Includes all parts as shown

Fits: Relay Control Bracket
Models:
7 & M7

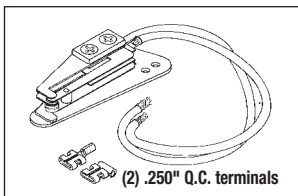

RPI Part #RCB003
OEM Part #H97948, H97966, H97076 & H97075

THERMAL DIAPHRAGM BELLOWS ASSEMBLY

- Mounts inside chamber under relay assembly
- Includes all parts as shown

Models:
7 & M7

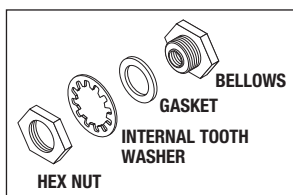

RPI Part #RCH118
Old RPI Part #RCH024
OEM Part #002-0839-00, H284687-1 & 002-0245-00

HEATER ELEMENT ASSEMBLY

- 1136W, 118VAC, ~12Ω
- Includes all parts as shown
- Replaces old RPI Part #RCH024
- New shape of heater allows for installation of Chamber Filter - see **Service Tip** for RPI Part #MIF062

Fits: Chamber
Models: 7 & M7

RPI Part #RCH119
OEM Part # (No OEM Part # Available)

ATTACHING HARDWARE

- Includes all parts as shown

Fits: Heating Element Assembly (RPI Part #RCH118) Only
Models: 7 & M7

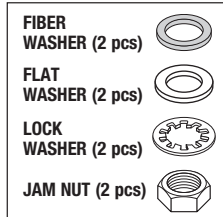

RPI Part #MIK134
OEM Part # 002-0243-00
(Gasket Only)

STERILIZER PM KIT

- Includes all parts as shown plus a PM Check List and PM Sticker

Models: 7 & M7

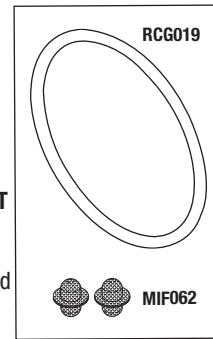

RPI Part #RCG019
OEM Part #002-0243-00, H98134 & 33166

DOOR GASKET

- 7.500" OD x .218" dia. C/S
- Material: White silicone

Fits: Chamber
Models: 7 & M7

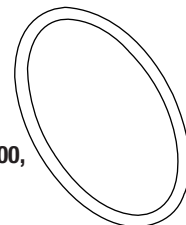

RCG019
CROSS SECTION
SHOWN ACTUAL SIZE

RPI Part #MIF062
OEM Part #002-0360-00 & 016-0790-00 (Mesh Style)

FILL/VENT MESH CHAMBER FILTER (Stainless Steel)

- 2 per package
- Size: 30 x 30 mesh stainless steel mesh
- Can be used to filter chamber debris at fill and vent ports

Fits: Chamber
Models: 7 & M7

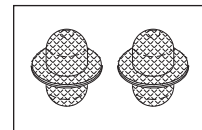

Service Tip

To help prevent clogging of the 7 or M7, install RPI Filter (RPI Part #MIF062) into the chamber end of the Water Fill/Exhaust line.

RPI Part #MIT047
OEM Part #002-0370-00 & 015-0647-00

OVERTEMP THERMOSTAT

- Automatic reset
- Opens @ 295 ±7°F Temp Rise
- Closes @ 240 ±12°F

Fits: Bracket that mounts to under side of chamber
Model: M7

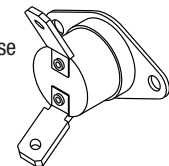

RPI Part #RCT050
OEM Part #H225639

MANUAL THERMOSTAT

- Push to reset
- Opens @ 335°F; Closes @ 290° F

Fits: Bracket that mounts to under side of chamber
Models: 7 & M7

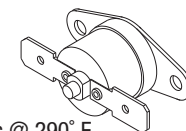

Table Top Sterilizers

Models: SpeedClave® 7 & SpeedClave® M7 (continued)

RPI Part #RCV112
OEM Part #014-0236-00

SOLENOID VALVE (FILL/VENT)

- 1/4" FPT; Piston style valve
 - 2 way; N.C.
 - Material: Brass body, Viton seals
 - 120VAC; 50/60Hz. FWR; 14W
- Fits:** Mounts on Chassis
Model: M7

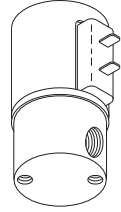

RPI Part #RCK113
OEM Part #014-0236-11

REPAIR KIT (FILL/VENT)

- Piston style repair kit
 - Material: Viton seals
 - Includes all parts as shown
 - Also included In: Solenoid Valve (Fill/Vent) (RPI Part #RCV112)
- Fits:** Solenoid Valve (Fill/Vent)
Model: M7

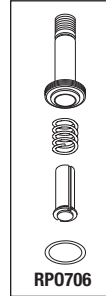

RPI Part #RCC114
OEM Part #014-0236-10

COIL (FILL/VENT)

- 1/4" Tabs
 - 180°C, 3.24-3.96 MEG Ω
 - 120VAC; 50/60Hz. FWR; 14W
- Fits:** Solenoid Valve (Fill/Vent)
Model: M7

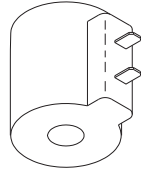

Need Repair Kit?

Need Coil?

RPI Part #ILS014

OEM Part # (No OEM Part # Available)

SPANNER NUT

- .525" ID x .875" HEX x .250" thk.
- Material: Stainless steel
- Replacement end for Double Ended Spanner Wrench (RPI Part #RPT501) or use as a stand alone Spanner Nut

Fits: Solenoid Valve (Fill/Vent)

Model: M7

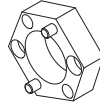

RPI Part #RPT501

OEM Part # (No OEM Part # Available)

DOUBLE ENDED SPANNER WRENCH

- Size: .875" HEX x ~7" lg.
- Material: Aluminum handle with stainless steel end attachments
- Reversible and replaceable end attachments for easy replacement of damaged pins

Fits: Solenoid Valve (Fill/Vent)

Model: M7

Includes all parts as shown

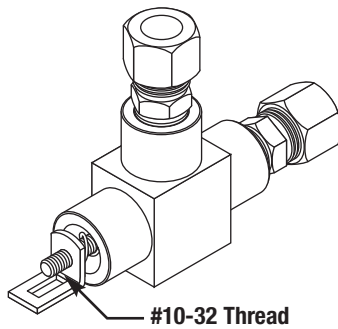
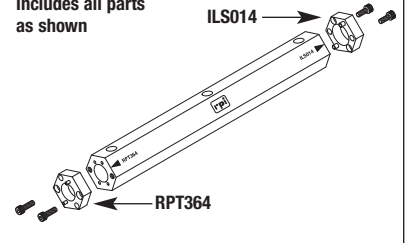

#10-32 Thread

RPI Part #RCV052
OEM Part #014-0402-00, H98136 & 36906

FILL VENT VALVE

- Material: Brass body; EP seals
- Includes (2) 3/8" male connector fittings and "L" Bracket
- Also available, Valve Stem Kit (RPI Part #RCS098), O-Ring (RPI Part #RPO306) and O-Ring (RPI Part #RPO307)

Fits: Fill-Vent bracket assembly

Models: 7 (all Serial #'s); M7 (Serial #'s V2200 thru present); M7 (011 Serial #'s MH3105 thru present); M7 (012 Serial #'s MJ1242 thru present); M7 (014 Serial #'s ML4210 thru present); M7 (013/015/016 all Serial #'s)

Service Tip

The Valve Stem Kit (RPI Part #RCS097) fits the Fill Vent Valve with (2) of the same sized O-rings (RPI Part #RPO306) and 1/4-28 Thread.

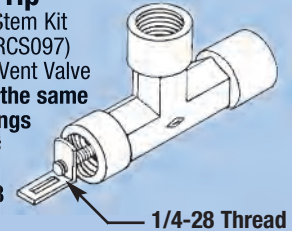

RPI Part #RCS097

OEM Part # (No OEM Part # Available)

VALVE STEM KIT

- Includes all parts as shown
- Fits:** Fill-Vent Valve with (2) of the same sized O-rings (RPI Part #RPO306) and 1/4-28 Thread

Models: 7 & M7 *See Service Tip above.*

STEM

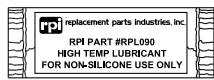
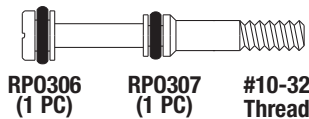

RPL090 (1 pc)

RPI Part #RCS098
OEM Part #002-0247-00

VALVE STEM KIT

- Includes all parts as shown
- Fits:** Original OEM and RPI Fill-Vent Valve (RPI Part #RCV052) with (2) different sized O-rings (RPI Part #RPO306) & (RPI Part #RPO307) and #10-32 Thread

Models: 7 & M7

STEM

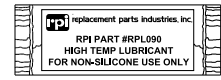
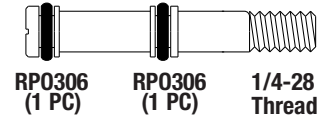

RPL090 (1 pc)

RPI Part #RPO306
OEM Part #H98136 & 36906
Industry Part #2-008

O-RING

- 12 per package;
 - Material: EPDM; Hardness: 70 Duro
 - .176" ID x .316" OD x .070" C/S
- Fits:** Fill Vent Valve **Models:** 7 & M7



RPI Part #RPO307
OEM Part #H98138 & 146180
Industry Part #2-006

O-RING

- 12 per package;
 - Material: EPDM; Hardness: 70 Duro
 - .114" ID x .254" OD x .070" C/S
- Fits:** Fill Vent Valve **Models:** 7 & M7



Service Tip

- If the stem has (2) of the same sized o-rings, then you need (2 pcs) RPI Part #RPO306.
- If the stem has (2) different sized o-rings, then you need (1 pc) RPI Part #RPO306 and (1 pc) RPI Part #RPO307.

INDEPENDENT BUZZER-STYLE TIMER

- Use this Kit to replace or upgrade a Timer with an independent buzzer. (Use Time Switch (RPI Part #RCT048) if you need a timer with a built-in bell.)
- Timer Knob sold separately – see RPI Part #'s RCK111 and RCK092.
- The Wire Harness in this Kit may be needed to extend the length of the original Wire Harness when upgrading to this style timer.

RPI Part #RCK116
OEM Part #002-0373-00

TIMER KIT (30 MIN)

- Timer Knob sold separately – see RPI Part #RCK092 or RPI Part #RCK111

Fits: Front Panel
Model: M7

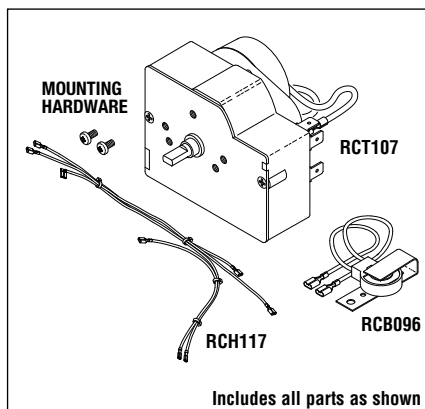

RPI Part #RCK111
OEM Part #053-1008-01

TIMER KNOB

- Fits 3/16" dia. shaft
- Material: Black ABS
- Includes installed set screw

Fits: Timer
Model: M7

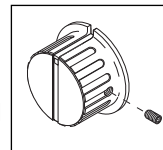

RPI Part #RCK092
OEM Part #H98062

TIMER KNOB

- Fits 3/16" dia. shaft
- Dial: 0-30 minutes
- Shaft hole is a spring clip
- Black plastic; aluminum skirt and inlay

Fits: Timer
Models: 7 & M7

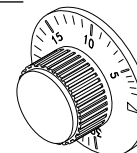

RPI Part #RCT107
OEM Part #
(No OEM Part # Available)

TIMER (30 MIN)

- Includes mounting screws
- Timer Knob sold separately – see Timer Knob (RPI Part #RCK092) or Timer Knob (RPI Part #RCK111)

Fits: Front Panel
Model: M7

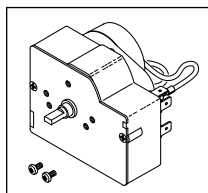

RPI Part #RCB096
New OEM Part #015-1813-00
Old OEM Part #015-0745-02

BUZZER

- 120 Volt, 60 Hz
- 7" lg. wire leads with 1/4" quick disconnect terminals

Fits: Machine Base
Model: M7

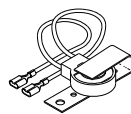

RPI Part #RCH117
OEM Part #
(No OEM Part # Available)

WIRE HARNESS

- This Wire Harness may be needed to extend the length of the original Wire Harness when upgrading to the buzzer-style Timer (RPI Part #RCT107)

Fits: Original Wire Harness
Model: M7

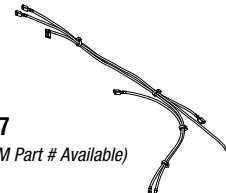

BUILT-IN BELL-STYLE TIMER

- Use this Timer to replace a Timer with a built-in bell. This timer will not work in conjunction with machines that utilize an independent buzzer. (Use Timer Kit (RPI Part #RCK116) if you need a timer with an independent buzzer.)

RPI Part #RCT048
OEM Part #H284667-1

TIME SWITCH (60 MIN)

- Timer with bell replaces electric timer
- ±5% accuracy
- Switch: 20A@120VAC, 10A@250VAC
- SPST

Models: 7 & M7-without buzzer

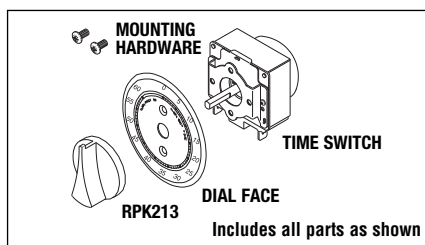

RPI Part #RPK213
OEM Part #
(No OEM Part # Available)

KNOB

- Material: Black ABS
 - Fits 3/16" double flat shaft
- Fits:** Time Switch (RPI Part #RCT048) only
Models: 7 & M7



RPI Part #RCA099
OEM Part #H98064

FLEX CABLE ASSEMBLY

- 1/8" dia. cable by 7-5/8" lg.
- Material: Stainless steel cable

• Accommodates a 90° bend
Fits: Front Panel and Relay Assembly
Models: 7 & M7

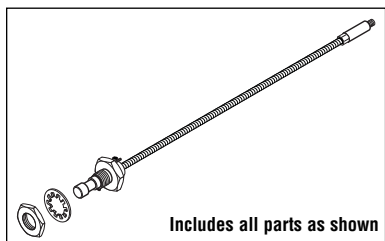

RPI Part #RCK110
OEM Part #053-1008-00

TEMPERATURE KNOB

- Material: Black ABS
- Fits 1/4" dia. shaft
- Includes installed set screw

Fits: Flex Cable Assembly
Model: M7

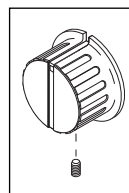

RPI Part #RCK093
OEM Part #H98063

CONTROL KNOB

- Black plastic with aluminum inlay
- Shaft hole is 1/4" dia.

Fits: Flex Cable Assembly
Models: 7 & M7

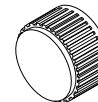

Table Top Sterilizers

Models: SpeedClave® 7 & SpeedClave® M7 (continued)

RPI Part #RCL090
OEM Part #H98036

PILOT LIGHT (RED)

- 125 VAC, 1/2 W
- Lens: Red
- 3/16" Tabs
- .50" dia. mounting hole

Fits: Front Panel

Models: 7 & M7

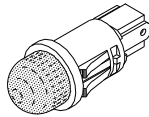

RPI Part #RCL121
OEM Part #015-1304-00

PILOT LIGHT (GREEN)

- 125VAC, 1/2W
- Lens: Green
- 3/16" Tabs
- .50" dia. mounting hole

Fits: Front Panel

Model: M7

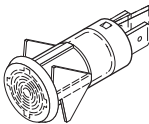

RPI Part #RCS115
OEM Part #015-1791-00

FILL/VENT SWITCH

- Panel cutout: .550" x 1.125"
- SPST (momentary on) paddle switch
- 10A @ 125VAC, 5A @ 250VAC
- 1/4" Tabs
- Color: Black body with Black paddle

Fits: Front Panel

Model: M7

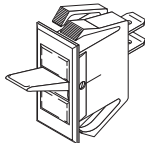

RPI Part #RCG085
OEM Part #002-0242-00

TEMPERATURE GAUGE (DIAL THERMOMETER)

- 2" dial face
- Stem: 5" lg.
- Reads: 80°F - 276°F, (24°C - 134°C)
- Mounts to front panel
- Includes all parts as shown

Models: 7 & M7

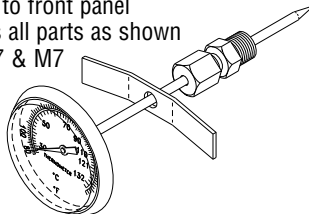

RPI Part #RCS086
OEM Part #H225730

SLEEVE

- 5 per package
- .125" ID x .312" OD x .220" lg.
- EPDM; 70 Duro

Fits: Temperature gauge

Models: 7 & M7



RPI Part #RPK431
OEM Part #002-0653-00

DRAIN TUBE ASSEMBLY KIT

- Includes all parts as shown
- Fitting: Polypropylene; Tubing: Clear PVC (3/8" ID. x 5/8" OD)

Fits: Front Panel/Female Quick Connect Fitting - Grey (RPI Part #RPF426)

Model: M7

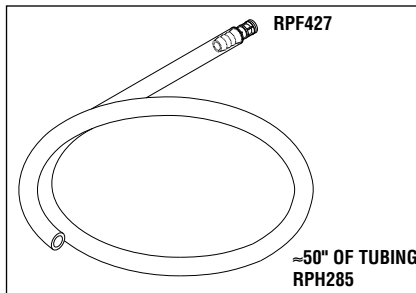

RPI Part #RPH285
OEM Part #053-0391-03 & 053-0391-02

DRAIN HOSE

- 3/8" ID x 5/8" OD x 1/8" Wall
- Clear PVC
- Use Kwik™ Clamp (RPI Part #RPC285) to secure tubing

Fits: Male Quick Connect Fitting (Grey) (RPI Part #RPF427)

Model: M7

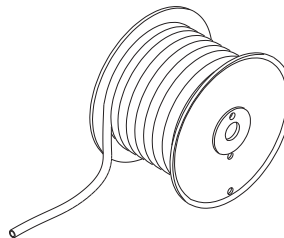

Sold by the foot; Reel not included

RPI Part #RPC286
OEM Part # 016-0748-01

KWIK™ CLAMP

- 6 per package
- Clamping Range: 11/16" - 13/16" Dia. (.688" x .812")
- Temperature Range: -40°F to +302°F
- Use to secure tubing (RPI Part #RPH285)

Fits: Drain Hose/Inner Tubing

Model: M7

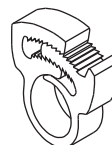

RPI Part #RPF426
OEM Part #053-0990-00

FEMALE QUICK CONNECT FITTING (GREY)

- Includes all parts as shown
- 3/8" (9.5 mm) hose barb: 0.28" Flow
- Body material: Polypropylene; Seals material: EPDM
- Bulkhead panel mount hose barb body with quick connect shut-off
- Operating temperature: 32°F to 160°F (0°C to 71°C)
- Working pressure: Vacuum to 105 PSI, 7.2 Bar

Fits: Front Panel/Drain Tube Assembly Kit (RPI Part #RPK431)

Model: M7

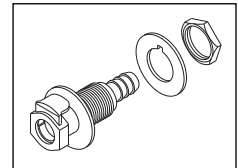

RPI Part #RPF427
OEM Part #053-0990-01

MALE QUICK CONNECT FITTING (GREY)

- Includes all parts as shown
- 3/8" (9.5 mm) hose barb: 0.28" Flow
- Body material: Polypropylene; Seals material: EPDM
- Operating temperature: 32°F - 160°F (0°C - 71°C)
- Working pressure: Vacuum to 105 PSI, 7.2 Bar

Fits: Female Quick Connect (RPI Part #RPF426) on Front Panel/Drain Tube Assembly Kit (RPI Part #RPK431)

Model: M7

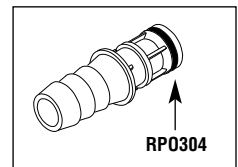

RPI Part #RPO304
OEM Part # (No OEM Part # Available)

Industry Part #AS568-011

O-RING

- 12 per package
- .301" ID x .441" OD x .070" C/S
- Material: Nitrile (Buna N); Duro: 70

Fits: Male Quick Connect Fitting (Grey) (RPI Part #RPF427)

Model: M7



SHOWN ACTUAL SIZE

RPI Part #RCB088
OEM Part #H96772

T-BOLT

- 5/16-24 thread
 - Material: Nickel plated brass
- Fits:** Door assembly
Models: 7 & M7

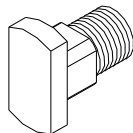

RPI Part #RCG104
OEM Part #053-1579-00

FIBER GASKET

- 5 per package
 - .312" ID x .562" OD x .062" THK
- Fits:** Door Assembly
Models: 7 & M7



RPI Part #RCW009
OEM Part #H96771 & 3059

DOOR WASHER

- .375" ID x .635" OD x .090" THK
 - Material: Copper, Nickel plated
- Fits:** Door Assembly (T-Bolt)
Models: 7 & M7

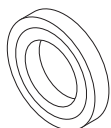

RPI Part #RCN094
OEM Part #H96773

CAP NUT

- 5/16-24 thread
 - Material: Stainless steel
- Fits:** T-Bolt in Door Assembly
Models: 7 & M7

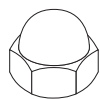

RPI Part #RPA032
OEM Part #042-0024-02

THREADLOCKER 242

- 5 per package
 - .02 fl. oz. (.5ml) per tube
 - Prevents rust and corrosion
 - Removable adhesive by Loctite®
- Fits:** Cap Nut and T-Bolt on the Door Assy
Models: 7 & M7

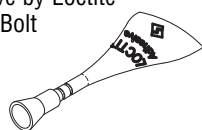

RPI Part #RCS108
OEM Part #H106330

DOOR SPRING

- 5 per package
 - .335" OD x 1.025" length inside hooks, .052" wire dia.
 - Material: Stainless steel
- Fits:** Door Assembly
Models: 7 & M7

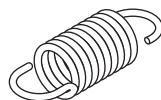

RPI Part #RCS012
OEM Part #040-0010-103, H96673 & 3046

HINGE SCREW

- #10-32 thread
 - Material: Hardened steel
- Fits:** Door Hinge
Models: 7 & M7

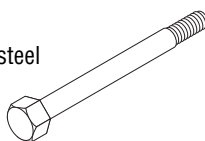

RPI Part #RCN013
OEM Part #041-0010-08 & 3047

HINGE SCREW NUT

- 5 per package
 - #10-32 thread
 - Material: Stainless steel
 - Flex lock
- Fits:** Hinge screw
Models: 7 & M7



RPI Part #RCP011
OEM Part #042-0007-07 & H97989

CAM PIN

- Includes cam pin and retaining ring
 - Material: Stainless steel
- Fits:** Cam Assembly
Models: 7 & M7

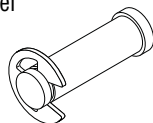

RPI Part #RCC010
OEM Part #34646

CAM

- Material: Stainless steel
- Fits:** Door Handle
Model: 7

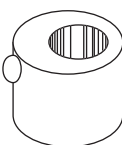

RPI Part #RCV051
OEM Part #H98089 & 11683

SAFETY VALVE (31 PSI)

- Cracking Pressure: 31 PSI
 - Brass; 1/8" MPT
- Models:** 7 & M7

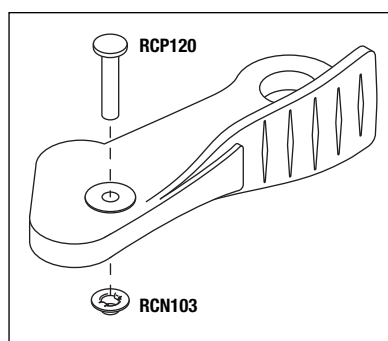
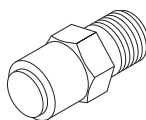

RPI Part #RCK106
NEW OEM Part #002-0248-00
OLD OEM Part #053-0513-00

DOOR HANDLE KIT

- Material: Nylon 6/6
 - Includes Cam Pin (RPI Part #RCP120), Push Cap Nut (RPI Part #RCN103) and Handle
- Fits:** Door Assembly
Models: 7 & M7

RPI Part #RCP120
OEM Part #042-0005-16

CAM PIN

- 1/2" dia. head, 1/4" dia. x 7/8" lg.
 - Material: Stainless steel
- Fits:** Door Handle Assembly
Models: 7 & M7

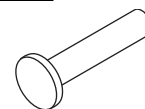

RPI Part #RCN103
OEM Part #K906034

PUSH CAP NUT

- 5 per package
 - Fits 1/4" dia. shaft
 - Material: Nickel plated steel
- Fits:** Cam Pin
Models: 7 & M7



RPI Part #RCC095
OEM Part #H98009

FILL COVER

- Material: Black ABS
- Fits:** Reservoir
Models: 7 & M7

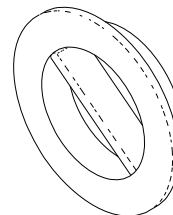

RPI Part #RCG087
OEM Part #H98135

RESERVOIR GASKET

- EPDM; 70 Duro
- Fits:** Reservoir
Models: 7 & M7

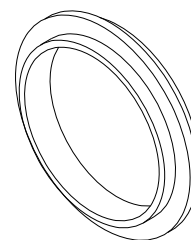

RCG087
CROSS SECTION
SHOWN ACTUAL SIZE

Table Top Sterilizers

Models: SpeedClave® 7 & SpeedClave® M7 (continued)

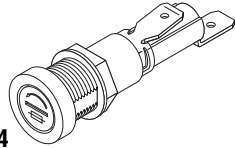

RPI Part #RPH674
OEM Part #015-1259-04

FUSE HOLDER

- 1/4" Tabs
- Uses standard (1/4" dia. x 1-1/4" lg.) fuse
- 20A @ 250VAC
- Low profile screwdriver slot knob
- Mounting hole: 1/2"
- Includes mounting hardware

Fits: Rear Panel
Model: M7

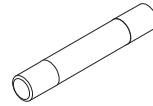

RPI Part #RPF679
OEM Part #015-0346-35

FUSE (12A, 250VAC) - FAST ACTING

- 5 per package
 - 1/4" dia. x 1-1/4" lg.
 - Material: Ceramic
- Fits:** Fuse Holder (RPI Part #RPH674)
Model: Models: M7



RPI Part #RPH673
OEM Part #040-0010-125

SELF DRILLING SCREW

- 6 per package
 - #10-16 thread x 3/4" lg.; Pan Head Phillips
 - Material: Stainless steel
- Fits:** Cover
Models: 7 & M7

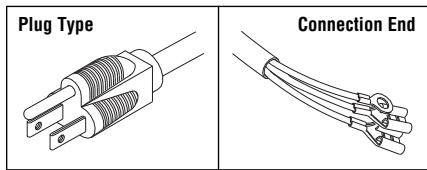

RPI Part #PCC003
OEM Part #H98159

INDUSTRIAL GRADE POWER CORD

- Color: Black
- Length: 8 ft.
- 16/3 HSJO, 90°C; 15A@125VAC
- Plug Type: NEMA 5-15P
- Connection End: (1) #8 Ring Terminal and (2) 1/4" quick connect Terminal; .350" OD Cord

Fits: Lower Chassis
Models: 7 & M7

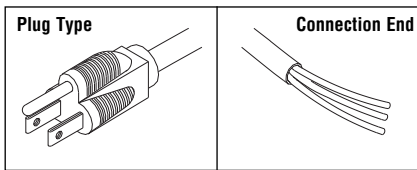

RPI Part #PCC004
OEM Part #H98159

POWER CORD WITHOUT CONNECTORS

- Color: Black
- Length: 8 ft.
- 16/3 HSJO, 90°C; 15A@125VAC
- Plug Type: NEMA 5-15P
- Connector Type: None; 0.350 OD Cord

Fits: Lower Chassis
Models: 7 & M7



RPI Part #PCN136
OEM Part # (No OEM Part # Available)

SPEEDNUT

- 10 per package
 - "U" type #10-24 thread
- Models:** 7 & M7

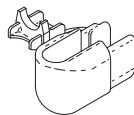

RPI Part #RPB167
OEM Part #H98160

STRAIN RELIEF BUSHING

- 6 per package
- Type: SR-11-2
- Cord Type: Round Cable
- Cord OD Range: .325" - .355"
- Mounting Hole: 5/8"
- For easy installation, use Strain Relief Bushing Pliers (RPI Part #RPT172)
- Also included in Strain Relief Bushing Kit (RPI Part #RPK412)

Fits: Power Cord on Lower Chassis
Models: 7 & M7

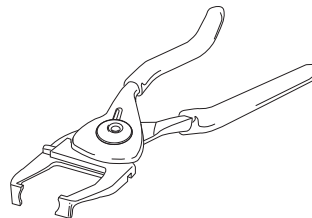

RPI Part #RPT172
OEM Part # (No OEM Part # Available)

STRAIN RELIEF BUSHING PLIERS

- hand pliers adjustable for all bushings that assemble into mounting hole up to 7/8" dia.
- 7" lg.

Models: 7 & M7

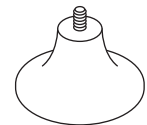

RPI Part #RCF016
OEM Part #H98021

SUCTION CUP FOOT

- 4 per package
- #10-32 thread x .375" lg. stud
- High profile shoulder

Models: 7 & M7

RPI Part #RPT113
OEM Part #011-0012-00

MAX REGISTER THERMOMETER

- Mercury
- Length: 5-1/2"
- Accuracy Rating: ±1 Div. (±2°F)
- Range: 150°F to 350°F
- Includes thermometer, and metal protective case

Models: 7 & M7

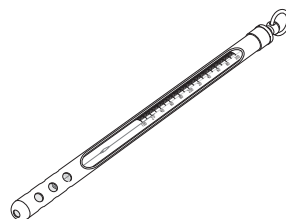

Replace the Door and Dam Gaskets at the same time ... See RPI's PM Kits!

RPI Part #MIG027
OEM Part #053-0366-00

DOOR GASKET

- ~10.750" OD
- Material: Silicone rubber
- Fits:** Door
- Models:** M9-001 thru -019, M9-020 thru -022, M9D-001 thru -019 & M9D-020 thru -022

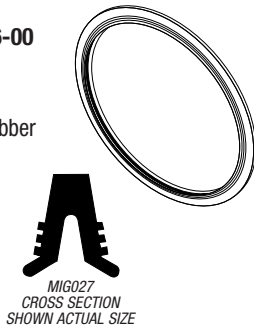

RPI Part #MIG028
OEM Part #053-0527-00

DOOR GASKET

- ~12.875" OD
- Material: Silicone rubber
- Fits:** Door
- Models:** M11-001 thru -019, M11-020 thru -022, M11D-001 thru -019 & M11D-020 thru -022



RPI Part #MIG157
OEM Part #053-0508-00

DAM GASKET

- Material: Silicone rubber
- **Only Fits:** Door with metal flap (OEM Part #030-0698-00)
- Fits:** Door **with** metal flap
- Models:** M9-001 thru -019 & M9D-001 thru -019

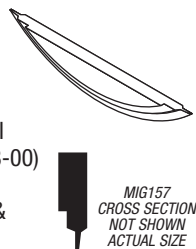

RPI Part #MIG035
OEM Part #053-0903-00

DAM GASKET

- Material: Silicone rubber
- Redesigned to channel water back into the chamber and it's easier to install
- **Only Fits:** Door without metal flap (OEM Part #030-1016-00)
- Fits:** Door **without** metal flap
- Models:** M9-001 thru -019, M9-020 thru -022, M9D-001 thru -019 & M9D-020 thru -022

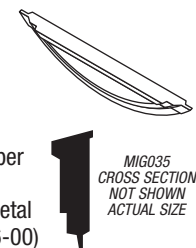

RPI Part #MIG036
OEM Part #053-0904-00

DAM GASKET

- Material: Silicone rubber
- Redesigned to channel water back into the chamber and it's easier to install
- Models:** M11-001 thru -019, M11-020 thru -022, M11D-001 thru -019 & M11D-020 thru -022

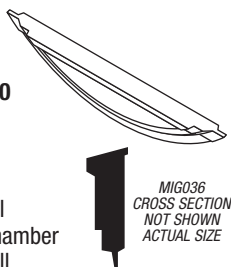

RPI Part #MIK158
OEM Part #002-0361-00
(Door & Dam Gasket only)

STERILIZER PM KIT

- Includes all parts as shown plus a PM Check List & PM Sticker
- Also available: Sterilizer PM Kit (RPI Part #MIK072) for door **without** metal flap
- Fits:** Door **with** metal flap (OEM Part #030-0698-00)
- Models:** M9-001 thru -019 & M9D-001 thru -019

Kit Fits M9 & M9D (door with metal flap)

MIF062 
Mesh Chamber Filter
For newer style machines

MIF038 
Sintered Bronze Filter
For older style machines

MIS076 

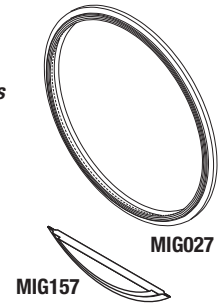

RPI Part #MIK072
OEM Part #002-0361-01
(Door & Dam Gasket only)

STERILIZER PM KIT

- Includes all parts as shown plus a PM Check List & PM Sticker
- Also available: Sterilizer PM Kit (RPI Part #MIK158) for door **with** metal flap
- Fits:** Door **without** metal flap (OEM Part #030-1016-00)
- Models:** M9-001 thru -019, M9-020 thru -022, M9D-001 thru -019 & M9D-020 thru -022

Kits Fits M9 & M9D (door without metal flap)

MIF062 
Mesh Chamber Filter
For newer style machines

MIF038 
Sintered Bronze Filter
For older style machines

MIS076 

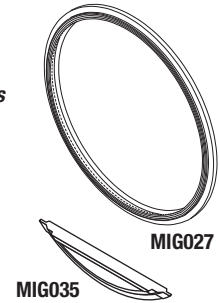

RPI Part #MIK080
OEM Part #002-0504-00
(Door & Dam Gasket only)

STERILIZER PM KIT

- Includes all parts as shown plus a PM Check List & PM Sticker
- Models:** M11-001 thru -019, M11-020 thru -022, M11D-001 thru -019 & M11D-020 thru -022

Kit Fits all M11 & M11D

MIF062 
Mesh Chamber Filter
For newer style machines

MIF038 
Sintered Bronze Filter
For older style machines

MIS076 

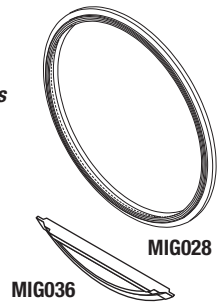

RPI Part #MIF038
OEM Part #002-0360-00 (Sintered Style) 

FILTER (SINTERED STYLE)

- Sintered bronze
- 100-150 micron filter
- Fits:** Chamber (older style units)
- Models:** M9-001 thru -019, M9D-001 thru -019, M11-001 thru -019 & M11D-001 thru -019

RPI Part #MIF062
OEM Part #002-0360-00 (Mesh Style) 

FILL/VENT MESH CHAMBER FILTER (Stainless Steel)

- 2 per package
- Size: 30 x 30 mesh stainless steel
- Filters chamber debris at fill and vent ports
- Fits:** Chamber (newer style units)
- Models:** M9-001 thru -019, M9-020 thru -022, M9D-001 thru -019, M9D-020 thru -022, M11-001 thru -019, M11-020 thru -022, M11D-001 thru -019 & M11D-020 thru -022

RPI Part #MIS076
OEM Part #050-2347-00

DOOR SPRINGS

- 2 per package; *Note: (2) springs makes it easier to open chamber door*
- Stainless steel
- Fits:** Chamber
- Models:** M9-001 thru -019, M9-020 thru -022, M9D-001 thru -019, M9D-020 thru -022, M11-001 thru -019, M11-020 thru -022, M11D-001 thru -019 & M11D-020 thru -022

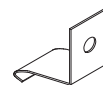

Table Top Sterilizers

Models: UltraClave® M9 & M9D, M11 & M11D (continued)

You have a choice...It's the RPI Advantage!

RPI offers two different Air Vent Bellows Assemblies – RPI Part #RCB100 and RCB089. There are two different styles of assemblies – the diaphragm style and the bellows style. Here's the difference.

The **RPI RCB089 and the OEM's are both diaphragm style assemblies.** This style has only one convolution doing all the work (by expanding and contracting).

The other style is a **bellows assembly – the RPI RCB100.** This style assembly, offered only by RPI, has several convolutions doing all of the work so it lasts much longer than the diaphragm style.

RPI Part #RCB089
New OEM Part #002-0375-00
Old OEM Part #014-0193-00

AIR VENT BELLOWS ASSEMBLY

- 1/4" compression fittings-both ends
- Bronze diaphragm style;
- Stainless steel housing
- Actuates within 12°F of saturated steam temperature

Fits: Chamber to Condensing Tank (older style units)

Models:
 M9-001 thru -019,
 M9D-001 thru -019,
 M11-001 thru -019 &
 M11D-001 thru -019

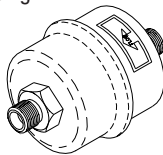

RPI Part #RCB100
New OEM Part #002-0375-00
Old OEM Part #014-0193-00

AIR VENT BELLOWS ASSEMBLY

- 1/4" compression fittings-both ends
- Bronze bellows style;
- Stainless steel housing
- Actuates within 5°F of saturated steam temperature

Fits: Chamber to Condensing Tank (older style units)

Models:
 M9-001 thru -019,
 M9D-001 thru -019,
 M11-001 thru -019 &
 M11D-001 thru -019

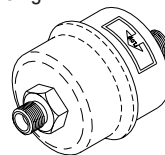

RPI Part #MIK078
OEM Part #002-0654-00

STEAM TRAP KIT (New Style/Upgrade Kit)

- Includes all parts as shown
- Also available: Steam Trap (RPI Part #MIV081)

Fits: Chamber to Condensing Tank (older style units)

Models:
 M9-001 thru -019,
 M9D-001 thru -019,
 M11-001 thru -019 &
 M11D-001 thru -019
 (Not for use with M7)

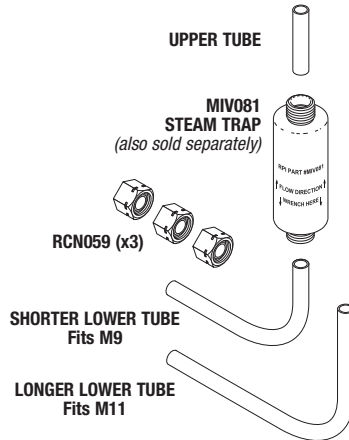

RPI Part #MIV081
OEM Part #002-0654-00

STEAM TRAP (New Style)

- For Upgrade Kit, see Steam Trap Kit (RPI Part #MIK078) above
 - 1/4" compression fittings on both ends
 - Material: Brass body, stainless steel & Teflon internal parts
- Fits:** Chamber to Condensing Tank (older style units)

Models: M9-001 thru -019, M9D-001 thru -019,
 M11-001 thru -019 & M11D-001 thru -019 (Not for use with M7)

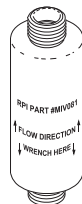

RPI Part #MIS044
OEM Part #002-0363-00

PULSE SOLENOID

- Single wound coil 120V/60Hz.; Blue Coil
- Includes all parts as shown
- 3/16" tabs
- Stroke: 1/2"; ~14.6Ω
- Pull type solenoid
- Also available: Latch Lever Pivot Kit (RPI Part #MIK201)

Fits: Door Latch Mounting Bracket (older style units)

Models: M9-001 thru -019 with Serial # prefixes CZ, DA, DB, DX, DY, FD & OM.

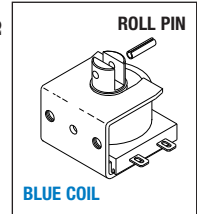

RPI Part #MIS079
OEM Part #002-0363-03

PULSE SOLENOID

- Single wound coil 120V/60Hz.; Black Coil
- Includes all parts as shown
- 3/16" tabs
- Stroke: 1/2"; ~11.6Ω
- Pull type solenoid
- Also available: Latch Lever Pivot Kit (RPI Part #MIK201)

Fits: Door Latch Mounting Bracket (older style units)

Models: M11-001 thru -019 with Serial # prefixes ES, ET, FP, FR & GB.

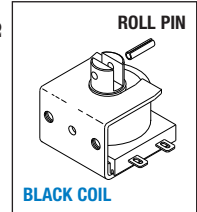

RPI Part #MIA086
OEM Part #050-2362-00

SPRING ARM

- Stainless steel
- Fits:** Switch Bracket
- Models:**
 M9-001 thru -019 &
 M9D-001 thru -019

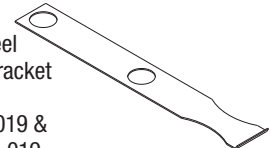

RPI Part #MIA077
OEM Part #050-3970-00/050-2623-00

SPRING ARM

- Stainless steel
- Fits:** Switch Bracket
- Models:**
 M11-001 thru -019 &
 M11D-001 thru -019

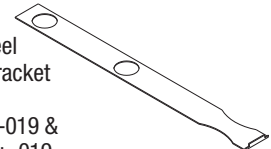

RPI Part #MIS039
OEM Part #002-0362-00

DOOR SWITCH ASSEMBLY

- Includes all parts as shown
- 0.1A@125/250VAC; SPDT; N.O.

Fits: Switch weldment (older style units)

Models: M9-001 thru -019, M9D-001 thru -019,
 M11-001 thru -019 & M11D-001 thru -019

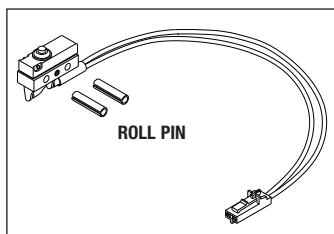

RPI Part #MIS095
OEM Part #015-1556-00

DOOR SWITCH ASSEMBLY

- 5A@250VAC; SPDT; N.O.

Fits: Latch Bracket (newer style units)

Models: M9-020 thru -022,
 M9D-020 thru -022,
 M11-020 thru -022 &
 M11D-020 thru -022

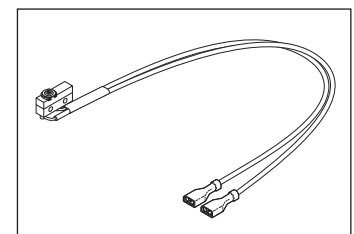



RPI Part #MIK202
OEM Part # (No OEM Part # Available)

FILL/VENT MANIFOLD KIT

- This Kit includes easier to remove hex head mounting bolts instead of Phillips Head screws - it's the RPI Advantage!
- Includes all parts as shown
- Assembly required - Instructions are included

Fits: Manifold Assembly
Models: M9-001 thru -019 & M11-001 thru -019

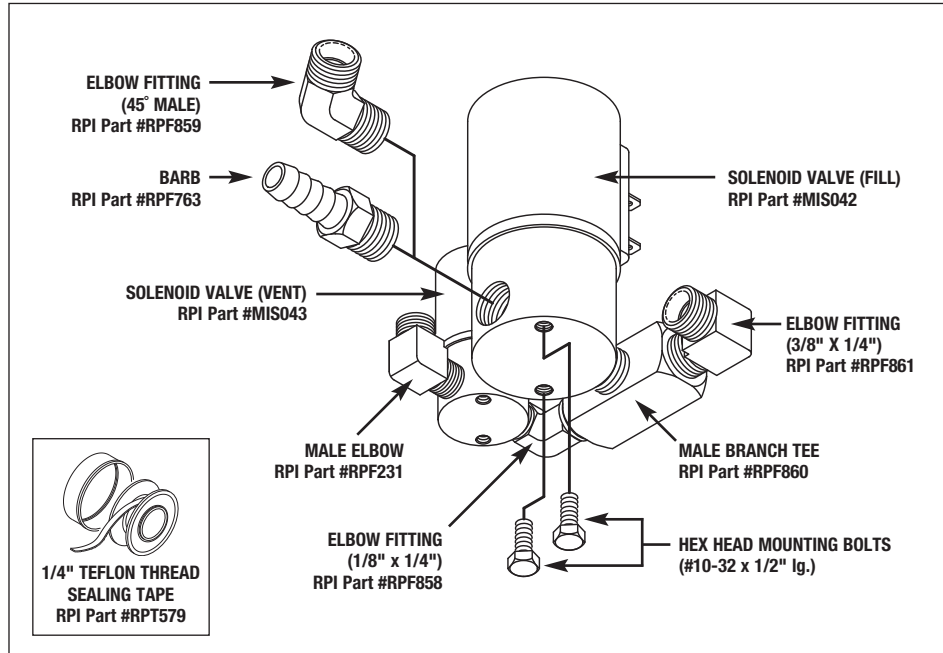

Non-FWR (Full-Wave Rectified) Solenoid Valves, Repair Kits & Coils

Tip: If the letters FWR appear on the Coil or the Valve nameplate, then you need FWR (full-wave rectified) replacement parts.

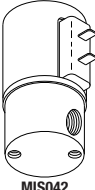
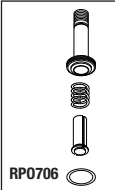
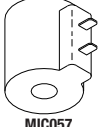
MODELS	VALVE TYPE	RPI PART #	OEM PART #	DESCRIPTION
M9, M9D, M11 & M11D -001 thru -019	<ul style="list-style-type: none"> • FILL VALVE • AC valve • Mounts on Chassis • Fits <u>older</u> style units 	MIS042	002-0365-00	SOLENOID VALVE (FILL) <ul style="list-style-type: none"> • 1/4" orifice, 1/4" FPT ports • 120VAC, 60 Hz., 10W • Included in: Fill/Vent Manifold Kit (RPI Part #MIK202)
 MIS042	 RPO706 MIK053	 MIC057	MIK053	REPAIR KIT (FILL VALVE) <ul style="list-style-type: none"> • Includes all parts as shown
			MIC057	COIL (FILL VALVE) <ul style="list-style-type: none"> • 130°C, 129-151Ω • 120VAC, 60 Hz. • 1/4" Tabs

Also available, Spanner Nut (RPI Part #ILS014) & Double Ended Spanner Wrench (RPI Part #RPT501) - see page 1012.

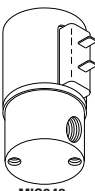
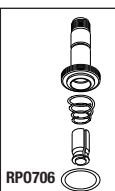
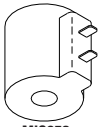
M9 & M11 -001 thru -019	<ul style="list-style-type: none"> • VENT VALVE • AC valve • Mounts on Chassis • Fits <u>older</u> style units 	MIS043	002-0366-00	SOLENOID VALVE (VENT) <ul style="list-style-type: none"> • 1/8" orifice, 1/8" FPT ports • 120VAC, 60 Hz., 7W • Included in: Fill/Vent Manifold Kit (RPI Part #MIK202)
 MIS043	 RPO706 MIK054	 MIC058	MIK054	REPAIR KIT (VENT VALVE) <ul style="list-style-type: none"> • Includes all parts as shown • This Kit does not include the Coil. For the Coil, see RPI Part #MIC058.
			MIC058	COIL (VENT VALVE) <ul style="list-style-type: none"> • 130°C, 368-432Ω • 120VAC, 60 Hz. • 3/16" Tabs • This part does not include the Repair Kit. For the Repair Kit, see RPI Part #MIK054.

Also available, Spanner Nut (RPI Part #ILS014) & Double Ended Spanner Wrench (RPI Part #RPT501) - see page 1012.

Table Top Sterilizers



Models: UltraClave® M9 & M9D, M11 & M11D (continued)

FWR (Full-Wave Rectified) Solenoid Valves, Repair Kits & Coils

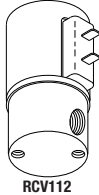
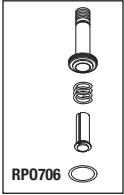
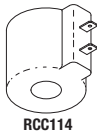
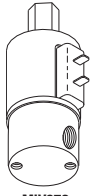
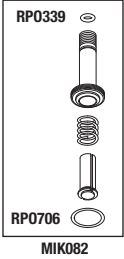
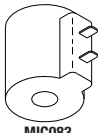
Tip: Look for the letters FWR on the Coil or the Valve nameplate to determine if you need full-wave rectified replacement parts.

MODELS	VALVE TYPE	RPI PART #	OEM PART #	DESCRIPTION
M9, M9D, M11 & M11D -001 thru -019   	<ul style="list-style-type: none"> • FILL VALVE (FWR only) • AC valve • Mounts on Chassis • Fits <u>older</u> style units 	RCV112	002-0365-00	SOLENOID VALVE • 1/4" orifice, 1/4" FPT ports • 120VAC, 50/60 Hz., FWR, 14W
		RCK113	014-0236-11	REPAIR KIT • Includes all parts as shown
		RCC114	014-0236-10	COIL (FILL/VENT VALVE) • 150°C, 3.24-3.96 MEG Ω • 120VAC, 50/60 Hz., FWR, 14W; 1/4" Tabs
<i>Also available, Spanner Nut (RPI Part #ILS014) & Double Ended Spanner Wrench (RPI Part #RPT501) - see page 1012.</i>				
M9D & M11D -001 thru -019   	<ul style="list-style-type: none"> • VENT VALVE (FWR only) • AC valve • Mounts on Chassis • Fits <u>older</u> style units 	MIV073	002-0519-00	SOLENOID VALVE (VENT) • 1/8" orifice; 1/8" FPT ports • 120VAC, 50/60 Hz., FWR, 10W
		MIK082	014-0275-02 (Repair Kit & Coil)	REPAIR KIT (VENT VALVE) • Includes all parts as shown below • This Kit does not include the Coil. For the Coil, see RPI Part #MIC083.
		MIC083	014-0275-02 (Repair Kit & Coil)	COIL (VENT VALVE) • 150°C, 3.24-3.96 MEG Ω • 120VAC, 50/60 Hz., FWR, 10W; 1/4" Tabs • This part does not include the Repair Kit. For the Repair Kit, see RPI Part #MIK082.
<i>Also available, Spanner Nut (RPI Part #ILS014) & Double Ended Spanner Wrench (RPI Part #RPT501) - see page 1012.</i>				

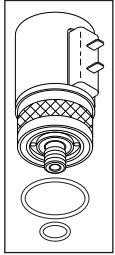
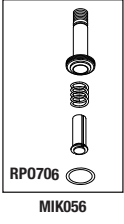
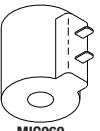
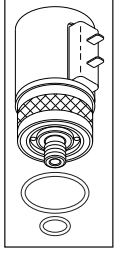
Manifold Mount Solenoid Valves, Repair Kits & Coils

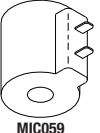
MODELS	VALVE TYPE	RPI PART #	OEM PART #	DESCRIPTION
M9-001 thru -019 Serial #'s CZ1000 thru CZ1109   	<ul style="list-style-type: none"> • FILL VALVE • Manifold mount • AC valve • Fits <u>older</u> style units 	MIS046	014-0200-00	SOLENOID VALVE (FILL) • 1/4" orifice; 1/2-20 THD • 120VAC, 60 Hz., 10W
		MIK056	No OEM Part # Available	REPAIR KIT (FILL VALVE) • Includes all parts as shown
		MIC060	No OEM Part # Available	COIL (FILL VALVE) • 180°C, 121-142Ω • 120VAC, 60 Hz. • 1/4" Tabs
<i>Also available, Spanner Nut (RPI Part #ILS014) & Double Ended Spanner Wrench (RPI Part #RPT501) - see page 1012.</i>				
M9-001 thru -019 Serial #'s CZ1000 thru CZ1109   	<ul style="list-style-type: none"> • VENT VALVE • Manifold mount • AC valve • Fits <u>older</u> style units 	MIS045	014-0199-00	SOLENOID VALVE (VENT) • 1/8" orifice; 5/16-24 THD • 120VAC, 60 Hz., 7W
		MIK055	No OEM Part # Available	REPAIR KIT (VENT VALVE) • Includes all parts as shown
		MIC059	No OEM Part # Available	COIL (VENT VALVE) • 180°C, 271-318Ω • 120VAC, 60 Hz. • 3/16" Tabs
<i>Also available, Spanner Nut (RPI Part #ILS014) & Double Ended Spanner Wrench (RPI Part #RPT501) - see page 1012.</i>				

Solenoid Valves, Repair Kits & Coils

MODELS	VALVE TYPE	RPI PART #	OEM PART #	DESCRIPTION
M9, M9D, M11 & M11D -020 thru -022	<ul style="list-style-type: none"> • AIR VALVE (FWR only) • AC valve • Non-manifold mount • Fits newer style units 	MIV118	014-0419-00	SOLENOID VALVE (AIR VALVE) <ul style="list-style-type: none"> • 1/8" orifice; 1/8" FPT ports • 120VAC, 60 Hz., FWR
		MIK119	No OEM Part # Available	REPAIR KIT (AIR VALVE) <ul style="list-style-type: none"> • Includes all parts as shown
		MIC120	No OEM Part # Available	COIL (AIR VALVE) <ul style="list-style-type: none"> • 180°C, 3.24-3.96 MEG Ω • 120VAC, 60 Hz., FWR, 7W • 1/4" Tabs
M9, M9D, M11 & M11D -020 thru -022	<ul style="list-style-type: none"> • FILL VALVE (FWR only) • AC valve • Manifold mount • Fits newer style units 	MIV138	002-1360-00 & 014-0420-02	SOLENOID VALVE (FILL) <ul style="list-style-type: none"> • 120VAC, 50/60 Hz., FWR, 14W • Included in: Fill/Vent Valve Assembly (RPI Part #MIA137)
		RCK113	014-0236-11	REPAIR KIT (Fits FILL VALVE - KIP only) <ul style="list-style-type: none"> • Includes all parts as shown
		RCC114	014-0236-10	COIL (FILL or VENT VALVE - KIP only) <ul style="list-style-type: none"> • 150°C, 3.24-3.96 MEG Ω • 120VAC, 50/60 Hz., FWR, 14W • 1/4" Tabs
M9, M9D, M11 & M11D -020 thru -022	<ul style="list-style-type: none"> • VENT VALVE (FWR only) • AC valve • Manifold mount • Fits newer style units 	MIV139	002-1361-00 & 014-0420-03	SOLENOID VALVE (VENT) <ul style="list-style-type: none"> • 120VAC, 50/60 Hz., FWR, 14W • Included in: Fill/Vent Valve Assembly (RPI Part #MIA137)
		MIK110	014-0420-03	REPAIR KIT (Fits VENT VALVE - KIP only) <ul style="list-style-type: none"> • Includes all parts as shown
		RCC114	014-0236-10	COIL (FILL or VENT VALVE - KIP only) <ul style="list-style-type: none"> • 150°C, 3.24-3.96 MEG Ω • 120VAC, 50/60 Hz., FWR, 14W • 1/4" Tabs

Also available, Spanner Nut (RPI Part #ILS014) & Double Ended Spanner Wrench (RPI Part #RPT501) - see page 1012.

Also available, Spanner Nut (RPI Part #ILS014) & Double Ended Spanner Wrench (RPI Part #RPT501) - see page 1012.

RPI Part #MIA137
OEM Part #029-2755-00 & 002-1362-00

FILL/VENT VALVE ASSEMBLY

- Piston style valves
- Material: Brass body and fittings, Viton solenoid seat
- 120VAC, 50/60 Hz. FWR, 14W
- Includes all parts as shown

Fits: Chassis

Models:

M9-020 thru -022,
M9D-020 thru -022,
M11-020 thru -022 &
M11D-020 thru -022

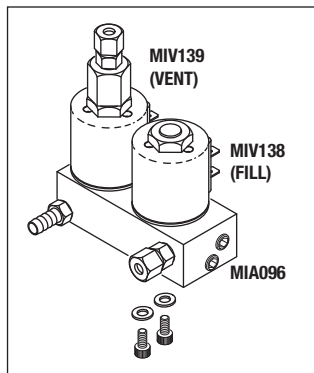

RPI Part #MIA096
OEM Part #029-2755-00 (Manifold Only) & 002-1362-00 (Manifold Only)

MANIFOLD BLOCK ASSEMBLY

- Material: Brass body and fittings
- Includes all parts as shown
- Included in: Fill/Vent Valve Assembly (RPI Part #MIA137)

Fits: Fill/Vent Valve Assembly

Models:

M9-020 thru -022,
M9D-020 thru -022,
M11-020 thru -022 &
M11D-020 thru -022

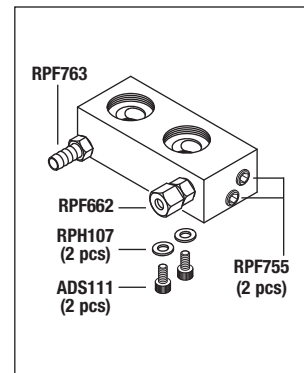

Table Top Sterilizers

Models: UltraClave® M9 & M9D, M11 & M11D (continued)

RPI Part #ADS111
OEM Part # (No OEM Part # Available)

SCREW (#6-32 x 3/8" lg.)

- 25 per package
- Material: Stainless steel
- Size: #6-32 x 3/8" lg. socket head cap screw
- Included in: Manifold Block Assembly (RPI Part #MIA096), Fill/Vent Valve Assembly (RPI Part #MIA137) and Socket Head Cap Screw Kit (RPI Part #ADK110)

Fits: Manifold Block Assembly

Models:

M9-020 thru -022, M9D-020 thru -022,
M11-020 thru -022 & M11D-020 thru -022

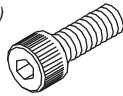

RPI Part #RPF755
OEM Part # (No OEM Part # Available)

PLUG

- 4 per package
- Material: Brass
- Size: 1/8" MPT
- Included in: Manifold Block Assembly (RPI Part #MIA096) and Fill/Vent Valve Assembly (RPI Part #MIA137)

Fits: Manifold Block Assembly

Models:

M9-020 thru -022, M9D-020 thru -022,
M11-020 thru -022 & M11D-020 thru -022



RPI Part #RPF860
OEM Part #014-0224-00

MALE BRANCH TEE

- Material: Brass
- Size: 1/4" MPT x 1/4" FPT x 1/4" FPT
- Included in: Fill/Vent Manifold Kit (RPI Part #MIK202)

Fits: Manifold Assembly

Models: M9-001 thru -019 &
M11-001 thru -019

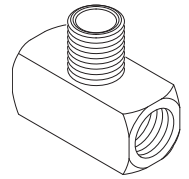

RPI Part #RPF228
OEM Part # (No OEM Part # Available)

MALE CONNECTOR

- 5 per package
- Material: Brass
- Size: 3/16" tubing x 1/4" MPT
- Included in: Solenoid Valve (Vent) (RPI Part #MIV139) & Fill/Vent Valve Assembly (RPI Part #MIA137)

Fits: Solenoid Valve (Vent)

Models: M9-020 thru -022, M9D-020 thru -022,
M11-020 thru -022 & M11D-020 thru -022

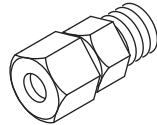

RPI Part #RPF763
OEM Part #014-0347-00

BARB

- 2 per package
- Material: Brass
- Size: 3/8" barb to 1/4" MPT
- Included in: Manifold Block Assembly (RPI Part #MIA096), Fill/Vent Valve Assembly (RPI Part #MIA137) and Fill/Vent Manifold Kit (RPI Part #MIK202)

Fits: Fill/Vent Manifold and Manifold Block Assembly

Models: M9-001 thru -019, M9-020 thru -022,
M9D-020 thru -022, M11-001 thru -019,
M11-020 thru -022 & M11D-020 thru -022

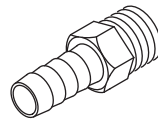

RPI Part #RPF861
OEM Part #014-0184-01

ELBOW FITTING (3/8 X 1/4)

- Material: Brass
- Size: 3/8" tubing x 1/4" MPT
- Included in: Fill/Vent Manifold Kit (RPI Part #MIK202)

Fits: Manifold Assembly

Models: M9-001 thru -019 &
M11-001 thru -019

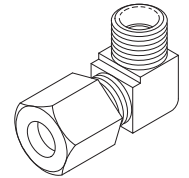

RPI Part #RPF231
OEM Part # (No OEM Part # Available)

MALE ELBOW

- 5 per package
- Material: Brass
- Size: 1/4" tubing x 1/8" MPT
- Included in: Fill/Vent Manifold Kit (RPI Part #MIK202)

Fits: Fill/Vent Manifold

Models: M9-001 thru -019 &
M11-001 thru -019

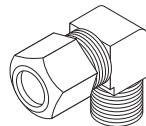

RPI Part #RPF858
OEM Part #014-0218-01

ELBOW FITTING (1/8 X 1/4)

- Material: Brass
- Size: 1/8" MPT x 1/4" MPT
- Included in: Fill/Vent Manifold Kit (RPI Part #MIK202)

Fits: Manifold Assembly

Models: M9-001 thru -019 &
M11-001 thru -019

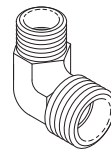

RPI Part #RPH107
OEM Part # (No OEM Part # Available)

WASHER (#6 FLAT)

- 50 per package
- Material: Stainless steel
- Size: ~.149" ID x .375" OD x .032" thk.
- Included in: Manifold Block Assembly (RPI Part #MIA096), Fill/Vent Valve Assembly (RPI Part #MIA137) and Hardware Kit (RPI Part #RPK402)

Fits: Manifold Block Assembly

Models:

M9-020 thru -022, M9D-020 thru -022,
M11-020 thru -022 & M11D-020 thru -022



RPI Part #RPF662
OEM Part #014-0183-02

MALE CONNECTOR

- Material: Brass
- Size: 3/8" tubing x 1/4" MPT
- Includes: Compression Nut (RPI Part #RPF222) and Compression Sleeve (RPI Part #RPF218)
- Included in: Manifold Block Assembly (RPI Part #MIA096) and Fill/Vent Valve Assembly (RPI Part #MIA137)

Fits: Fill/Vent Valve Assembly

Models:

M9-020 thru -022, M9D-020 thru -022,
M11-020 thru -022 & M11D-020 thru -022

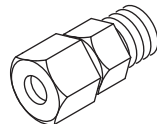

RPI Part #RPF859
OEM Part #014-0201-00

ELBOW FITTING (45° MALE)

- Material: Brass
- Size: 3/8" tubing x 1/4" MPT
- Included in: Fill/Vent Manifold Kit (RPI Part #MIK202)

Fits: Manifold Assembly

Models: M9-001 thru -019 &
M11-001 thru -019

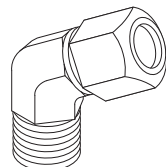

RPI Part #RPT862
OEM Part #053-1033-01/
053-1033-02/053-1033-04/053-1033-05

TUBING (3/8 ID NEOPRENE)

- Size: 3/8" ID x 1/2" OD; Color: Black
- Sold by the foot, reel not included

Fits: Water Reservoir to Fill Valve

Models: M9-001 thru -019, M9-020 thru -022,
M9D-001 thru -019, M9D-020 thru -022,
M11-001 thru -019, M11-020 thru -022,
M11D-001 thru -019 & M11D-020 thru -022

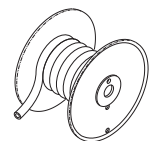

RPI Part #MIC143
OEM Part #002-0396-00 (Speed Clean)

MID-CLEAN™

- Sterilizer cleaning solution
- (1) 16 oz. bottle

Models:

M9-001 thru -019,
M9-020 thru -022,
M9D-001 thru -019,
M9D-020 thru -022,
M11-001 thru -019,
M11-020 thru -022,
M11D-001 thru -019 &
M11D-020 thru -022



Also available by the case of 12 bottles!

RPI Part #MIC144
OEM Part #002-0396-01 (Speed Clean)

MID-CLEAN™ (CASE)

- Sterilizer cleaning solution
- (12) 16 oz. bottles

Models:

M9-001 thru -019,
M9-020 thru -022,
M9D-001 thru -019,
M9D-020 thru -022,
M11-001 thru -019,
M11-020 thru -022,
M11D-001 thru -019 &
M11D-020 thru -022



RPI Part #RPK791
OEM Part # (No OEM Part # Available)

CLEANING KIT

- Supplied in a convenient sturdy canvas Carrying Case (RPI Part #RPC799)
- Includes all parts as shown
- All items also sold separately (see chart below)

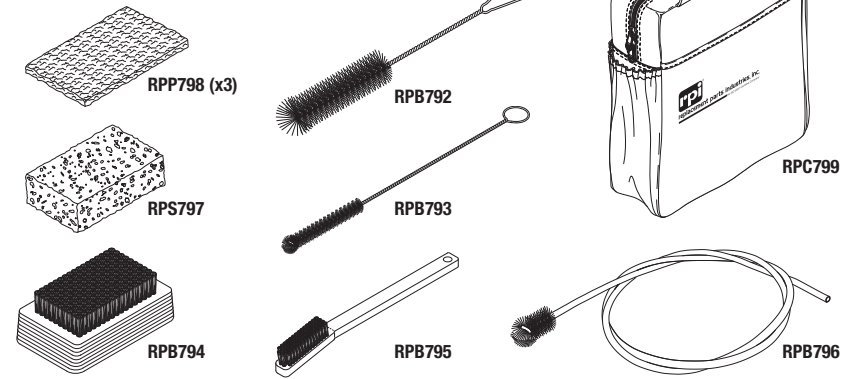

RPI Part #	Description	Kit Quantity	Reorder Quantity
RPB792	LARGE DIA. BRUSH (1-3/4" dia. x 4-1/2" lg.; 11-1/2" lg.)	1	1
RPB793	SMALL DIA. BRUSH (3/8" dia. x 1-3/4" lg.; 8" lg.)	1	1
RPB794	SCRUB BRUSH (2-1/2" x 4-1/4")	1	1
RPB795	HANDLE BRUSH (1-3/4" lg.; 6-5/8" lg.)	1	1
RPB796	FLEXIBLE TUBE BRUSH (7/8" dia. x 1-1/8" lg.; 41" lg.)	1	1
RPC799	CARRYING CASE	1	1
RPP798	CLEANSING PAD (6" x 9")	3	3
RPS797	SPONGE (4-1/4" x 6" x 1-5/8")	1	3

Reversible and replaceable end attachments allow easy replacement of damaged pins!

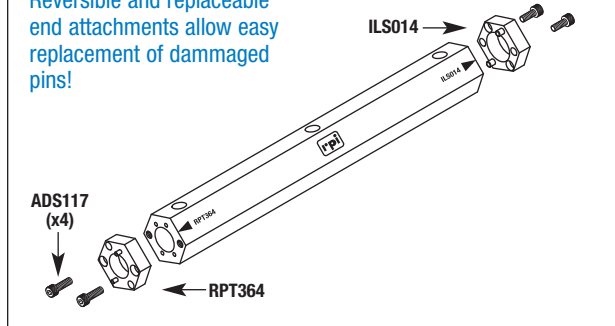

RPI Part #RPT501
OEM Part # (No OEM Part # Available)

DOUBLE ENDED SPANNER WRENCH

- Size: .875" HEX x ~7" lg.
 - Material: Aluminum handle with stainless steel end attachments
 - Includes all parts as shown
 - Reversible and replaceable end attachments allow easy replacement of damaged pins
 - Versatile! Also may be used for servicing *Midmark • Ritter*: M7; *Pelton & Crane*: Delta 10" (AF), Delta 8" (AE), Delta Q10, Delta Q8, Delta XL10, Delta XL8, Validator 10, Validator 8; *SciCan*: Stat/M® 900 Series, Stat/M® 2000 Series & Stat/M® 5000 Series
 - Holes thru handle allow use of screwdriver as a leverage handle
- Models:** M9-001 thru -019, M9-020 thru -022, M9D-001 thru -019, M9D-020 thru -022, M11-001 thru -019, M11-020 thru -022, M11D-001 thru -019 & M11D-020 thru -022

RPI Part #ILS014
OEM Part # (No OEM Part # Available)

SPANNER NUT

- Size: .525" ID x .875" HEX x .250" thk.
 - Dimensions: .093" dia. dowel pins at .750" apart
 - Material: Stainless steel
 - Replacement end attachment for Double Ended Spanner Wrench (RPI Part #RPT501) or use as a stand alone Spanner Nut
 - Versatile! Also may be used for servicing *Midmark • Ritter*: M7; *Pelton & Crane*: Delta 10" (AF), Delta 8" (AE), Delta Q10, Delta Q8, Delta XL10, Delta XL8, Validator 10, Validator 8
- Models:** M9-001 thru -019, M9-020 thru -022, M9D-001 thru -019, M9D-020 thru -022, M11-001 thru -019, M11-020 thru -022, M11D-001 thru -019 & M11D-020 thru -022

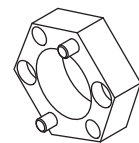

RPI Part #RPT364
OEM Part # (No OEM Part # Available)

SPANNER NUT

- Size: .453" ID x .875" HEX x .250" thk.
 - Dimensions: .062" dia. dowel pins at .587" apart
 - Material: Stainless steel
 - Replacement end attachment for Double Ended Spanner Wrench (RPI Part #RPT501) or use as a stand alone Spanner Nut
- Models:** *SciCan*: Stat/M® 900 Series, Stat/M® 2000 Series & Stat/M® 5000 Series

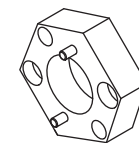
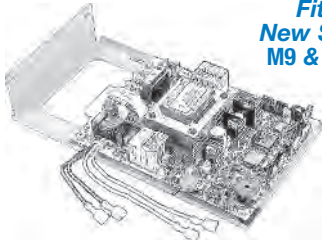

Table Top Sterilizers

Models: UltraClave® M9 & M9D, M11 & M11D (continued)



*Fits
New Style
M9 & M11*

RPI Part #MIB129
OEM Part #002-0762-00

CONTROL PC BOARD (REFURBISHED)

- Includes: Mounting Bracket
- When returning the old PC Board, **YOU MUST** include the Mounting Bracket.

Fits: Chassis

Models: M9-020 & -022 with Serial # prefixes RN, RR & V; and M11-020 & -022 with Serial # prefixes RS, RV & V only

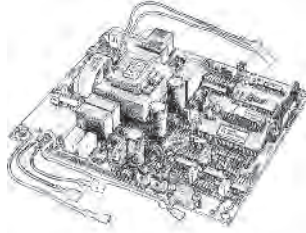

*Fits
Old Style
M9*

RPI Part #MIB130
OEM Part #002-0434-00/002-0434-03

CONTROL PC BOARD (REFURBISHED)

- Mounting Bracket not included
- When returning the old PC Board, **DO NOT** include the Mounting Bracket. Keep the old Mounting Bracket for later use.

Fits: Chassis

Models: M9-001 thru -019 with Serial # prefixes CZ, DA, DB, DX, DY, FD & OM

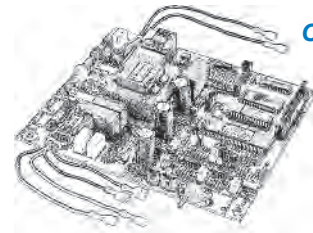

*Fits
Old Style
M11*

RPI Part #MIB131
OEM Part #002-0501-00

CONTROL PC BOARD (REFURBISHED)

- Mounting Bracket not included
- When returning the old PC Board, **DO NOT** include the Mounting Bracket. Keep the old Mounting Bracket for later use.

Fits: Chassis

Models: M11-001 thru -019 with Serial # prefixes ES, ET, FP, FR & GB

Here's How the \$100 Credit Exchange Program Works.

- 1) Place an order for a Control PC Board (PCB), and RPI will send a shipping box and prepaid UPS return label to you. You will not pay for shipping when using this box.
- 2) Using the shipping box and UPS return label, ship as follows:
 - Include the PCB and Mounting Bracket if shipping the *New Style M9 or M11* PCB (OEM Part #002-0762-00).
 - Do not include the Mounting Bracket if shipping the *Old Style M9 or M11* PCB (OEM Part #'s 002-0434-00/002-0434-03/002-0501-00).
- 3) Once the non-operational board has been received by RPI and verified that it is in reasonable condition without burn holes, a replacement PCB will be shipped to you. Your invoice will reflect the cost of the board plus the \$100 credit for the Core.

Important Information. PC Board performance verified and tested. Quality Control test printout is included with each PC Board. 90 Day Warranty.

Warning. To avoid damaging the replacement PC Board and possibly voiding the warranty, check the condition of the *Heater and/or Pulse Solenoid* prior to installing the replacement PC Board. **DO NOT** use PC Board in 220V or version "D" sterilizers.

RPI Part #MIK159
OEM Part # (No OEM Part # Available)

PCB MOUNTING KIT

- Includes all parts as shown
- Fits:** PC Board to Mounting Bracket and Chassis

Models: M9-001 thru -019, M9-020 thru -022, M9D-001 thru -019, M9D-020 thru -022, M11-001 thru -019, M11-020 thru -022, M11D-001 thru -019 & M11D-020 thru -022

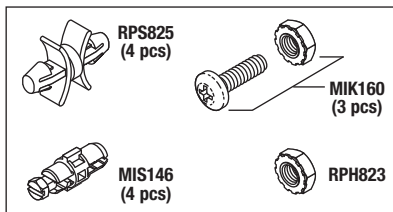

*One Kit
Fits All
M9 & M11!*

RPI Part #MIK160
OEM Part # (No OEM Part # Available)

GROUND SCREW KIT

- Includes all parts as shown
- Included in: PCB Mounting Kit (RPI Part #MIK159)

Fits: PC Board to Mounting Bracket and Chassis
Models: M9-001 thru -019, M9-020 thru -022, M9D-001 thru -019, M9D-020 thru -022, M11-001 thru -019, M11-020 thru -022, M11D-001 thru -019, M11D-020 thru -022

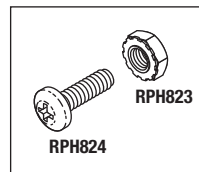

RPI Part #MIK117
OEM Part # (No OEM Part # Available)

PRESSURE TUBE KIT

- Includes all parts as shown
- Translucent silicone tubing

Fits: Control PC Board to Tube Fitting
Models: M9-001 thru -019, M9-020 thru -022, M9D-001 thru -019, M9D-020 thru -022, M11-001 thru -019, M11-020 thru -022, M11D-001 thru -019 & M11D-020 thru -022

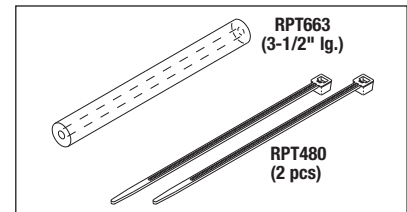

RPI Part #MIH135
OEM Part #015-0657-00

HEATER HARNESS

- Size: ~14.00" lg. wire
- Fits:** PC Board to Heater (older style units only)
- Models:** M9-001 thru -019, M9D-001 thru -019, M11-001 thru -019 and M11D-001 thru -019

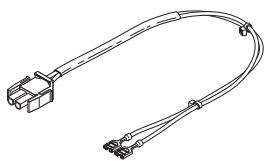

RPI Part #MIH136
OEM Part #015-0654-00

WATER LEVEL SENSOR HARNESS

- Size: ~14.75" lg. wire
- Fits:** PC Board to Water Level Sensor (older style units only)
- Models:** M9-001 thru -019, M9D-001 thru -019, M11-001 thru -019 & M11D-001 thru -019

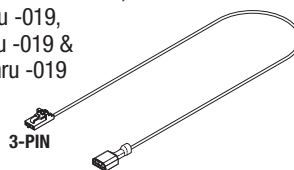

RPI Part #MIH145
OEM Part #015-1552-00

WATER LEVEL SENSOR HARNESS

- Size: ~18.00" lg. wire
- Fits:** PC Board to Water Level Sensor (newer style units only)
- Models:** M9-020 & -022, M9D-020 & -022, M11-020 & -022 & M11D-020 & -022

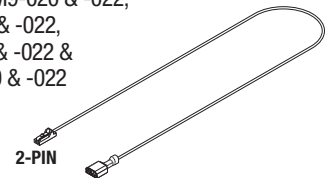

Field Service Calibration Smart Kit® For Servicing Midmark•Ritter® UltraClave® Autoclaves

RPI Part #MIK074 (No OEM Part # Available)

- Check and adjust pressure and temperature.
- Plus, Kit includes a durable plastic case and a troubleshooting information booklet.
- For use with older style units.

Models:

M9-001 thru -019,
M9D-001 thru -019,
M11-001 thru -019 &
M11D-001 thru -019

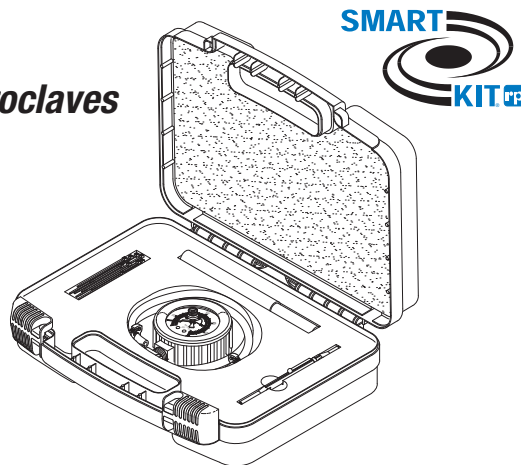

Kit includes all parts shown below!

RPI Part #RPT460

OEM Part # (No OEM Part # Available)

TRIM POT ADJUSTMENT TOOL

- ~5" Long
- Plastic with stainless steel blades
- Includes shirt pocket clip
- For use with older style units

Fits: Most trim pots

Models: M9-001 thru -019,
M9D-001 thru -019,
M11-001 thru -019 &
M11D-001 thru -019



RPI Part #RPC476

OEM Part # (No OEM Part # Available)

CARRYING CASE

- Plastic case with foam inserts. (The "pick-n-pluck" foam inserts can be customized by you to create your own storage design and a blank case label is included for custom description to fit your needs.)

- Outside dimensions:
14" L x 10.50" W x 3.37" D

Models: M9-001 thru -019,
M9-020 thru -022,
M9D-001 thru -019,
M9D-020 thru -022,
M11-001 thru -019,
M11-020 thru -022,
M11D-001 thru -019,
M11D-020 thru -022

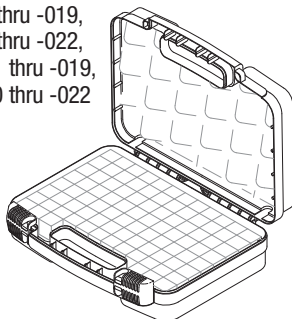

RPI Part #RPG461

OEM Part #002-0372-00

TEST PRESSURE GAUGE

- Includes all parts as shown
- 2 1/2" dial face; Maximum indicator pointer
- Dual scale: 0-60 PSI/0-400 KPA
- Gauge has rubber protective cover
- Tubing length on each side: ~12" lg.
- Can be used on most sterilizers for in-line pressure check
- For use with older style units

Models: M9-001 thru -019, M9D-001 thru -019,
M11-001 thru -019 & M11D-001 thru -019

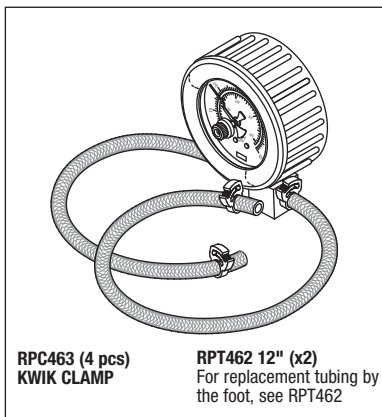

**RPC463 (4 pcs)
KWIK CLAMP**

**RPT462 12" (x2)
For replacement tubing by
the foot, see RPT462**

RPI Part #RPT113

OEM Part #011-0012-00

MAX REGISTER THERMOMETER

- Mercury; Size: ~.40" OD x ~6.63" lg.
- Accuracy Rating: ±1 Div. (±2°F)
- Dual scale: 150°F to 350°F/65°C to 177°C
- Includes Metal Protective Case

Models: M9-001 thru -019, M9-020 thru -022,
M9D-001 thru -019, M9D-020 thru -022,
M11-001 thru -019, M11-020 thru -022,
M11D-001 thru -019 &
M11D-020 thru -022

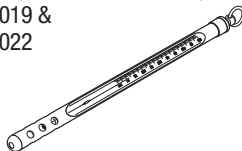

RPI Part #RPT480

OEM Part #015-0013-05 (1/pkg)

CABLE TIE (HIGH TEMP)

- 25 per package
- Color: Aqua blue
- Material: Tefzel®
- 1/8" wide x 4" lg.
- Temperature rating: Up to 338°F
- Resistant to most chemicals

Models: M9-001 thru -019, M9-020 thru -022,
M9D-001 thru -019, M9D-020 thru -022,
M11-001 thru -019, M11-020 thru -022,
M11D-001 thru -019 & M11D-020 thru -022



RPI Part #RPC463

OEM Part # (No OEM Part # Available)

KWIK™ CLAMPS

- 6 per package
- Material: Nylon®; Color: White
- Clamping range: .319" - .382" dia.
- Temperature range: -40°F to 302°F

Fits: 3/8" OD tubing

Models: M9-001 thru -019, M9-020 thru -022,
M9D-001 thru -019, M9D-020 thru -022,
M11-001 thru -019, M11-020 thru -022,
M11D-001 thru -019 & M11D-020 thru -022

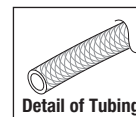
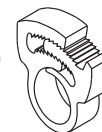

Detail of Tubing

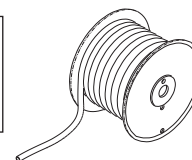

RPI Part #RPT462

OEM Part # (No OEM Part # Available)

TUBING (SILBRADE®)

- Sold by the foot, reel not included
- 1/8" ID x 3/8" OD; Translucent silicone tubing with reinforced braid
- Maximum temperature: 350°F
- Working Pressure: 233 PSI @ 70°F
- **Reel not included**

Fits: Barbed Fittings (1/8" diameter)

Models: M9-001 thru -019, M9D-001 thru -019,
M11-001 thru -019 & M11D-001 thru -019

Table Top Sterilizers

Models: UltraClave® M9 & M9D, M11 & M11D (continued)

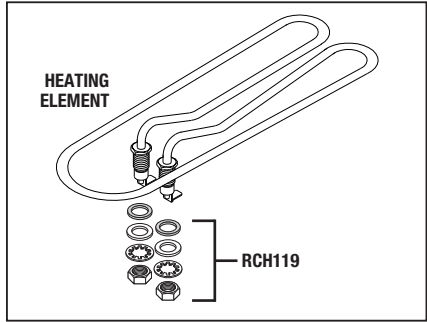

RPI Part #MIH048
OEM Part #002-0367-00

HEATER ELEMENT ASSEMBLY

- 1425W, 120VAC, ~10Ω
- ~3-7/16" W x 11-15/32" lg.
- Includes all parts as shown
- Also available: Heater Harness (RPI Part #MIH135)

Fits: Inside of Chamber
Models: M9-001 thru -019, M9-020 thru -022, M9D-001 thru -019 & M9D-020 thru -022,

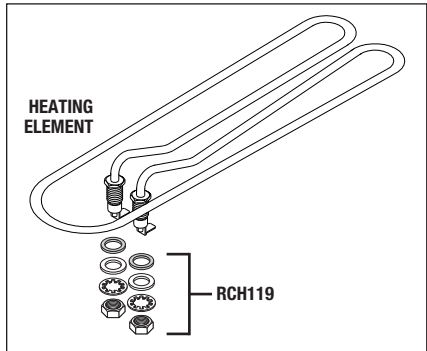

RPI Part #MIH049
OEM Part #002-0505-00

HEATER ELEMENT ASSEMBLY

- 1425W, 120VAC, ~10Ω
- ~3-7/16" W x 15-1/2" lg.
- Includes all parts as shown
- Also available: Heater Harness (RPI Part #MIH135)

Fits: Inside of Chamber
Models: M11-001 thru -019, M11-020 thru -022, M11D-001 thru -019 & M11D-020 thru -022

RPI Part #RCH119
OEM Part # (No OEM Part # Available)

ATTACHING HARDWARE

• Includes all parts as shown
Fits: Only RPI Heating Element Assembly (RPI Part #MIH048 & MIH049)

- Models:**
M9-001 thru -019,
M9-020 thru -022,
M9D-001 thru -019,
M9D-020 thru -022,
M11-001 thru -019,
M11-020 thru -022,
M11D-001 thru -019,
M11D-020 thru -022

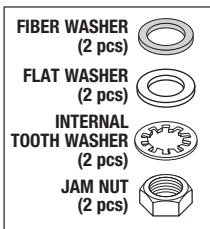

RPI Part #PCV052
OEM Part #002-0359-00

SAFETY VALVE (35 PSI)

- 1/2" MPT x 1/2" FPT
 - Brass body
- Fits:** Chamber (older style units)
Models: M9-001 thru -019, M9D-001 thru -019, M11-001 thru -019 & M11D-001 thru -019
(See RPI website for Serial # breakdown of all models this part fits)

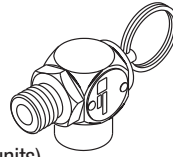

RPI Part #MIV090
OEM Part #002-0359-01

SAFETY VALVE (40 PSI)

- 1/2" MPT x 1/2" FPT
 - Brass body
 - Also available: Elbow Barb (RPI Part #RPF684)
- Fits:** Chamber (older style units)
Models: M9-001 thru -019, M9-020 thru -022, M9D-001 thru -019, M9D-020 thru -022, M11-001 thru -019, M11-020 thru -022, M11D-001 thru -019 & M11D-020 thru -022
(See RPI website for Serial # breakdown of all models this part fits)



RPI Part #RPF684
OEM Part #014-0258-00

ELBOW BARB FITTING

- 1/2" MPT x 3/4" barb
 - Black Nylon®
- Fits:** Safety Valve (35 PSI) and Safety Valve (40 PSI)
Models: M9-001 thru -019, M9-020 thru -022, M9D-001 thru -019, M9D-020 thru -022, M11-001 thru -019, M11-020 thru -022, M11D-001 thru -019 & M11D-020 thru -022
(See RPI website for Serial # breakdown of all models this part fits)

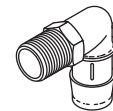

RPI Part #RPT863
OEM Part #053-0613-01/053-0613-02/053-0613-06/053-0613-07

TUBING (3/4 ID NEOPRENE)

- Size: 3/4" ID x 1" OD; Color: Black
 - Sold by the foot, reel not included
- Fits:** Safety Relief Valve & Elbow Barb Fitting
Models: M9-001 thru -019, M9-020 thru -022, M9D-001 thru -019, M9D-020 thru -022, M11-001 thru -019, M11-020 thru -022, M11D-001 thru -019 & M11D-020 thru -022

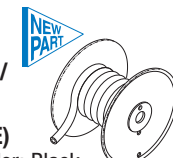

RPI Part #MIV122
OEM Part #014-0593-00

SAFETY VALVE (40 PSI)

- 1/8" MPT; Brass body
 - Includes all parts as shown
- Fits:** Chamber (newer style units)
Models: M9-020 & -022 with Serial #V721881 to present, M9D-020 & -022 with Serial #V721881 to present, M11-020 & -022 with Serial #V721881 to present, M11D-020 & -022 with Serial #V721881 to present

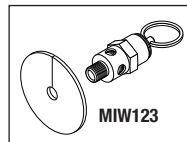

RPI Part #MIP050
OEM Part #002-0357-00

TEMPERATURE PROBE ASSEMBLY

- Material: Brass housing; 1/8" MPT
 - Size: ~12.00" lg. wire
- Fits:** Rear Chamber Port (older style units)
Models: M9-001 thru -019, M9D-001 thru -019, M11-001 thru -019 & M11D-001 thru -019

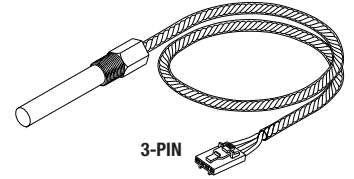

RPI Part #MIS121
OEM Part #015-1680-00

TEMPERATURE SENSOR

- Material: Stainless steel housing; 1/4" MPT
 - Range: ~1.07 to 1.1Ω @ 25°C (Positive Temperature Coefficient)
 - Size: ~18-1/2" lg. wire
- Fits:** Rear Chamber Port (newer style units)
Models: M9-020 thru -022, M9D-020 thru -022, M11-020 thru -022 & M11D-020 thru -022

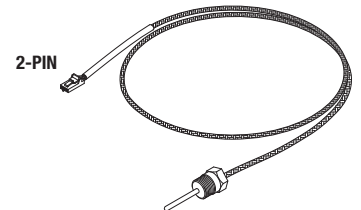

RPI Part #MIT047
OEM Part #002-0370-00

OVERTEMP THERMOSTAT

- Automatic reset
 - Opens @ 295 ±7°F
 - Closes @ 240 ±12°F
 - 1/4" tabs
- Fits:** Bracket that mounts to under side of Chamber (older style units)
Models: M9-001 thru -019, M9D-001 thru -019, M11-001 thru -019 & M11D-001 thru -019

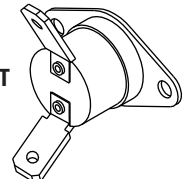

RPI Part #MIT093
OEM Part #015-1637-00

THERMOSTAT

- Automatic reset
 - Opens @ 450°F± 25°F;
 - Closes @ 364°F ± 20°F
 - 15A @ 120VAC; 10A @ 250VAC
 - 1/4" tabs
- Fits:** High Limit Switch Bracket (newer style units)
Models: M9-020 thru -022, M9D-020 thru -022, M11-020 thru -022 & M11D-020 thru -022

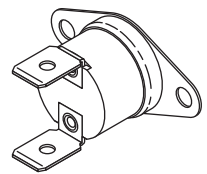

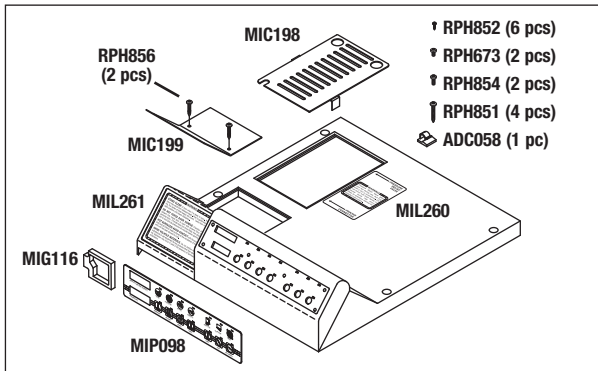

RPI Part #MIK196
OEM Part #002-0356-00

TOP COVER KIT

- Includes all parts as shown
 - Also available: Adhesive (RTV108) (RPI Part #RPA874), Display PC Board (RPI Part #MIB115) and Speednut (RPI Part #PCN136)
- Models:** M9-001 thru -019

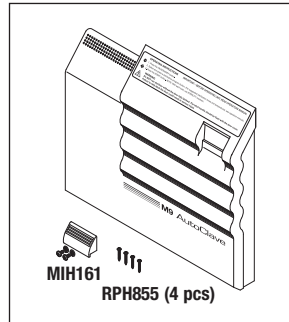

RPI Part #MIK194
OEM Part #002-0364-00/002-0364-01

DOOR PANEL KIT

- Includes all parts as shown
- Fits:** Door Frame
Models: M9-001 thru -019

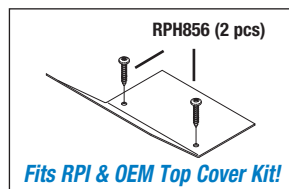

RPI Part #MIC199
OEM Part #050-1775-00

COVER PLATE (PRINTER)

- Includes all parts as shown
- Fits:** Top Cover
Models: M9-001 thru -019 & M9D-001 thru -019

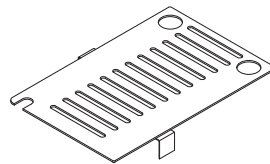

RPI Part #MIC198
OEM Part #030-1117-00/030-0765-10

TOP INSPECTION COVER

- Included in: Top Cover Kit (RPI Part #'s MIK196 and MIK197)
- Fits:** Top Cover
Models: M9-001 thru -019, M9D-001 thru -019, M11-001 thru -019 & M11D-001 thru -019

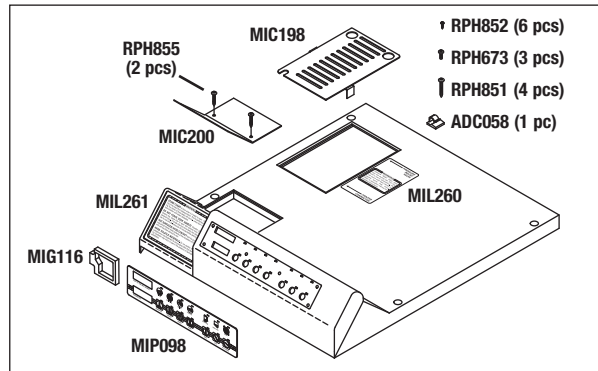

RPI Part #MIK197
OEM Part #002-0503-00

TOP COVER KIT

- Includes all parts as shown
 - Also available: Adhesive (RTV108) (RPI Part #RPA874), Display PC Board (RPI Part #MIB115) and Speednut (RPI Part #PCN136)
- Models:** M11-001 thru -019

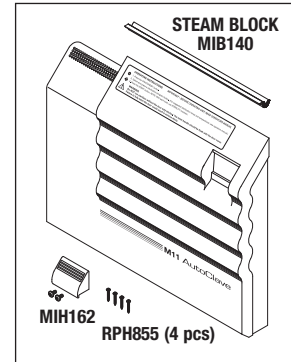

RPI Part #MIK195
OEM Part #002-0506-00/002-0506-01

DOOR PANEL KIT

- Includes all parts as shown
- Fits:** Door Frame
Models: M11-001 thru -019

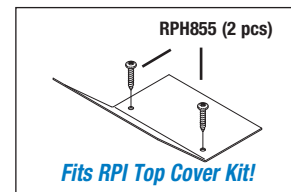

RPI Part #MIC200
OEM Part # (No OEM Part # Available)

COVER PLATE (PRINTER)

- Includes all parts as shown
- Fits:** *Only* RPI Top Cover Kit (RPI Part #MIK197)
Models: M11-001 thru -019

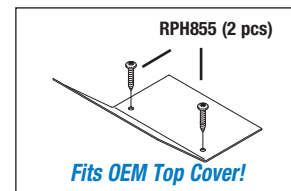

RPI Part #MIC203
OEM Part #050-2638-00

COVER PLATE (PRINTER)

- Includes all parts as shown
- Fits:** *Only* fits OEM Top Cover
Models: M11-001 thru -019

RPI Part #MIL260
OEM Part #061-0309-00, 061-0309-01

LABEL (PR VALVE WARNING)

- Size: 1.50" x 4.21" with adhesive backing
 - Included in: Top Cover Kits (RPI Part #'s MIK196 & MIK197)
- Fits:** Top Cover Near the Inspection Cover
Models: M9-001 thru 019 & M11-001 thru 019

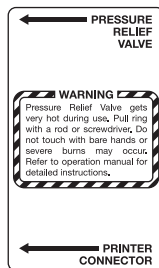

RPI Part #MIL261
OEM Part #061-0381-00, 061-0532-00

LABEL (WARNING)

- Size: 1.50" x 4.78" with adhesive backing
 - Included in: Top Cover Kits (RPI Part #'s MIK196 & MIK197)
- Fits:** Top Cover Near the Display Overlay
Models: M9-001 thru 019 & M11-001 thru 019



Table Top Sterilizers

Models: UltraClave® M9 & M9D, M11 & M11D (continued)

RPI Part #MIB115
OEM Part #002-0369-02, 015-0646-00 (Cable only) & 002-0369-00 (Display PC Board only)

DISPLAY PC BOARD

- Includes: (6) Screws (#6-32 X 3/8") (RPI Part #AIS170) for older style units with threaded inserts and (6) Screws (#6 x 3/8") (RPI Part #RPH852) for newer style units without threaded inserts
- This PC Board is HumiSeal® conformal coated

Fits: Top Cover
Models: M9-001 thru -019 & M11-001 thru -019

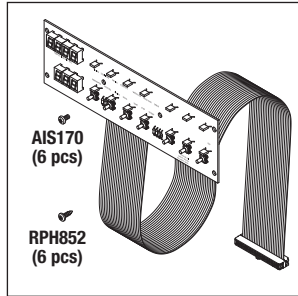

RPI Part #MIG116
OEM Part #053-0454-00

DISPLAY PC BOARD GASKET

- Material: Black foam rubber with adhesive backing
- Included in: Top Cover Kit (RPI Part #'s MIK196 and MIK197)

Fits: Top Cover (older style units)
Models: M9-001 thru -019 & M11-001 thru -019

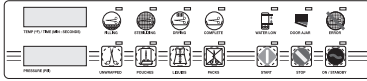
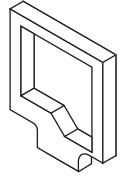

RPI Part #MIP098
OEM Part #061-0272-01

DISPLAY OVERLAY

- Adhesive backing
- Included in: Top Cover Kit (RPI Part #'s MIK196 and MIK197)

Fits: Top Cover (older style units)
Models: M9-001 thru -019 & M11-001 thru -019

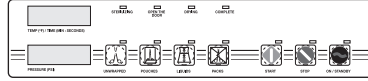

RPI Part #MIP097
OEM Part #061-0531-00

DISPLAY OVERLAY

- Adhesive backing
- Fits:** Top Cover (older style units)
- Models:** M9D-001 thru -019 with Serial # prefixes FF & FG and M11D-001 thru -019 with Serial # prefixes GC & GD

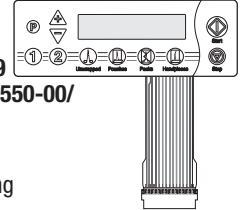

RPI Part #MIP099
OEM Part #015-1550-00/015-1551-00

TOUCH PAD

- Adhesive backing
- Fits:** Top Cover (newer style units)
- Models:** M9-020 thru -022, M9D-020 thru -022, M11-020 thru -022 & M11D-020 thru -022

RPI Part #MIH161
OEM Part #053-0912-00

DOOR HANDLE

- Includes: Handle, (2) Screws (#10-24 X .375" lg.) and (2) Retaining Washers (#10)
 - Included in: Door Panel Kit (RPI Part #MIK194)
- Fits:** Door (older style units)
Model: M9-001 thru -019

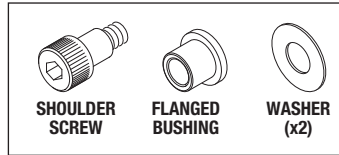
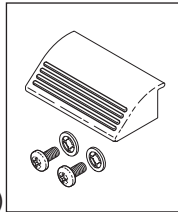

RPI Part #MIK201
OEM Part #042-0106-00/042-0106-01 (Shoulder screw only)/016-0131-18 (Flanged bushing only)/045-0000-04 (Washer only)

LATCH LEVER PIVOT KIT

- Includes: Stainless steel shoulder screw, flanged bushing, and (2) washers (for use in machines that do not use the flanged bushing)
- Fits:** Door Latch Mounting Bracket
- Models:** M9-001 thru -019, M9-020 thru -022, M11-001 thru -019 & M11-020 thru -022

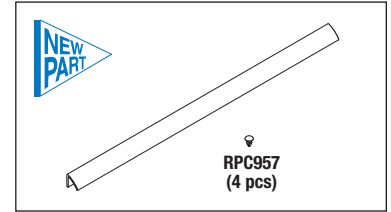

RPI Part #MIK236
OEM Part #002-1244-01

STEAM BLOCK KIT

- Material: Beige silicone rubber
- Size: 13.75" lg.
- Includes all parts as shown
- Fits:** Door Panel
- Models:** M9-020 thru -022 & M9D-020 thru -022



RPI Part #MIH162
OEM Part #053-0909-00

DOOR HANDLE

- Includes: Handle, (2) Screws (#10-24 X .375" lg.) and (2) Retaining Washers (#10)
 - Included in: Door Panel Kit (RPI Part #MIK195)
- Fits:** Door (older style units)
Model: M11-001 thru -019

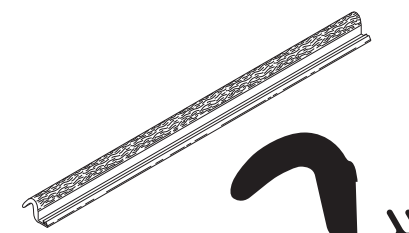
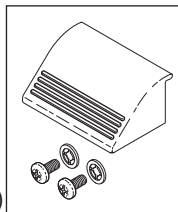

RPI Part #MIB140
OEM Part #053-0630-01

STEAM BLOCK

- Material: White plastic encapsulated foam
- Size: 12.0" lg.
- Included in: Door Panel Kit (RPI Part #MIK195)
- Fits:** Door Frame (older style units)
- Models:** M11-001 thru -019 & M11D-001 thru -019

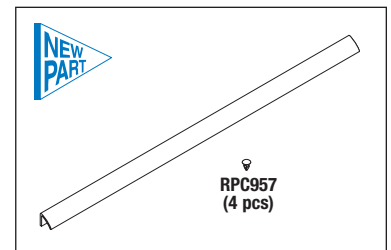

RPI Part #MIK237
OEM Part #002-1244-02

STEAM BLOCK KIT

- Material: Beige silicone rubber
- Size: 16.25" lg.
- Includes all parts as shown
- Fits:** Door Panel
- Models:** M11-020 thru -022 & M11D-020 thru -022



RPI Part #MIH163
OEM Part #053-1253-00

DOOR HANDLE

- Includes: Handle, (2) Screws (#10-24 X .375" lg.) and (2) Retaining Washers (#10)
 - Included in: Door Panel Kit (RPI Part #MIK195)
- Fits:** Door (newer style units)
Models: M9-020 thru -022, M9D-020 thru -022, M11-020 thru -022, & M11D-020 thru -022

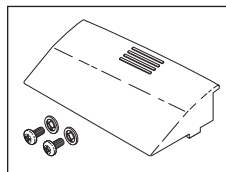

RPI Part #MIC226
OEM Part #053-0505-00

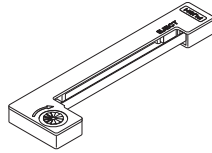

PRINTER CARTRIDGE

- Epson® brand ribbon cartridge; Color: Black
- Fits:** Printers (Old Style and New Style)
- Models:** M9-001 thru 019, M9-020 thru 022, M11-001 thru 019 & M11-020 thru 022

RPI Part #RPF281
OEM Part #015-0346-07

FUSE (15A, 250V)

- 5 per package
- 3AB; Ceramic; Fast-Acting
- Size: 1/4" dia. x 1-1/4" lg.

Fits: PC Board/Fuse Holder

- Models:** M9-001 thru -019, M9-020 thru -022, M9D-001 thru -019, M9D-020 thru -022, M11-001 thru -019, M11-020 thru -022, M11D-001 thru -019 & M11D-020 thru -022

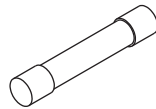

RPI Part #RPF049
OEM Part #015-0346-08

FUSE-PRINTER (3A, 250V)

- 5 per package
- AGC; Glass; Fast-Acting
- Size: 1/4" dia. x 1-1/4" lg.

Fits: PC Board

- Models:** M9-001 thru -019, M9D-001 thru -019, M11-001 thru -019 & M11D-001 thru -019

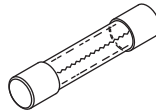

RPI Part #MIA180
OEM Part #002-0790-00

DOOR MOTOR ASSEMBLY

- 120 VAC
- Fits:** Chamber Frame
- Models:** M9-020 thru 022 & M11-020 thru 022

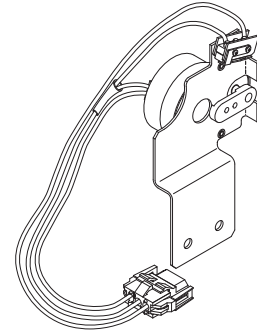

RPI Part #MIH238
OEM Part #015-1554-00 (Main Harness)/015-1640-00 (Hi Limit Jumper)

MAIN HARNESS

- Includes: Both the main harness and the high limit jumper
- Fits:** Main Control Board
- Models:** M9-020 thru -022 (Serial # prefixes RN, RP, RR & V), M9D-020 thru -022 (Serial # prefixes RW, RX & V), M11-020 thru -022 (Serial # prefixes RS, RT, RV & V) & M11D-020 thru -022 (Serial # prefixes RY, RZ & V)

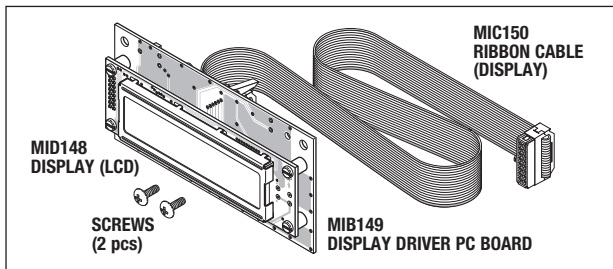
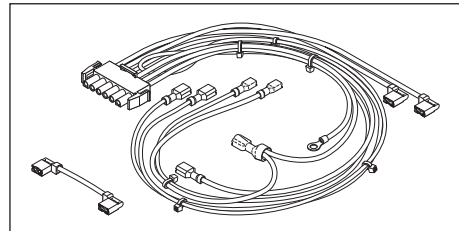

RPI Part #MIA147
OEM Part #015-1550-00/015-1550-02

DISPLAY ASSEMBLY

- Includes: Display (LCD) (RPI Part #MID148), Display Driver PC Board (RPI Part #MIB149), Ribbon Cable (RPI Part #MIC150), and mounting hardware
- Also available: Suppression Core (RPI Part #RPC762)

Fits: Top Cover (newer style units)

- Models:** M9-020 thru -022, M9D-020 thru -022, M11-020 thru -022 & M11D-020 thru -022

RPI Part #MID148
OEM Part # (No OEM Part # Available)

DISPLAY (LCD)

- Includes all parts as shown
- Included in: Display Assembly (RPI Part #MIA147)

- Fits:** Display Assembly (newer style units)
- Models:** M9-020 thru -022, M9D-020 thru -022, M11-020 thru -022 & M11D-020 thru -022

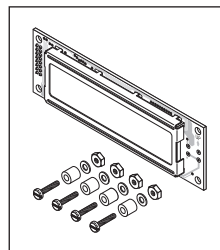

RPI Part #MIB149
OEM Part # (No OEM Part # Available)

DISPLAY DRIVER PC BOARD

- Included in: Display Assembly (RPI Part #MIA147)

- Fits:** Display Assembly (newer style units)
- Models:** M9-020 thru -022, M9D-020 thru -022, M11-020 thru -022 & M11D-020 thru -022

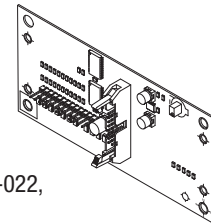

RPI Part #MIC150
OEM Part #015-1550-01, 015-1550-03

RIBBON CABLE (DISPLAY)

- Size: 18" lg.
- 16 Conductor Cable
- Included in: Display Assembly (RPI Part #MIA147)
- Also available: Suppression Core (RPI Part #RPC762)

- Fits:** Display Assembly (newer style units)
- Models:** M9-020 thru -022, M9D-020 thru -022, M11-020 thru -022 & M11D-020 thru -022

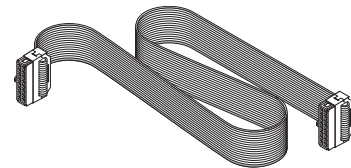

RPI Part #RPC762
OEM Part #015-1641-00

SUPPRESSION CORE

- Size: 1.95" W x 1.27" lg. x .64" thk
- Material: Plastic covered ferrite
- Snap action designed for flat cables up to 1.0" wide

- Fits:** Display Ribbon Cable (newer style units)
- Models:** M9-020 thru -022, M9D-020 thru -022, M11-020 thru -022 & M11D-020 thru -022

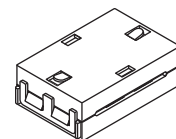
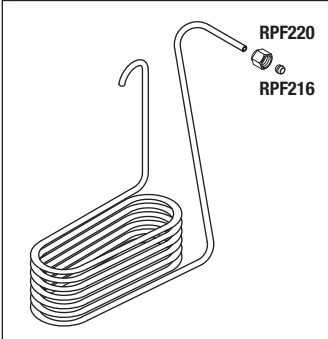

Table Top Sterilizers

Models: UltraClave® M9 & M9D, M11 & M11D (continued)



RPI Part #MIC037
OEM Part #052-0173-00

CONDENSATION COIL

- Includes all parts as shown
- Material: 1/4" dia. copper tubing

Fits: Reservoir Assembly (older style units)
Models: M9-001 thru -019, M9D-001 thru -019, M11-001 thru -019 & M11D-001 thru -019

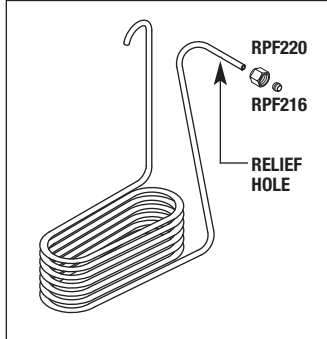

RPI Part #MIC094
OEM Part #014-0421-00

CONDENSATION COIL

- Includes all parts as shown
- Material: 1/4" dia. copper tubing

Fits: Water Reservoir (newer style units)
Models: M9-020 thru -022, M9D-020 thru -022, M11-020 thru -022 & M11D-020 thru -022

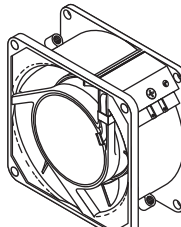

RPI Part #MIF091
OEM Part #015-1368-00

FAN

- 115VAC; 50/60 Hz; 3000 RPM
- Size: 3.15" H x 3.15" L x 1.50" W
- Material: Aluminum, black finish; Ball bearing construction

Fits: Water Reservoir (newer style units)
Models: M9-020 thru -022 with Serial # prefixes RN, RP, RR & V; M9D-020 thru -022 with Serial # prefixes RW, RX & V; M11-020 thru -022 with Serial # prefixes RS, RT, RV & V; and M11D-020 thru -022 with Serial # prefixes RY, RZ & V.

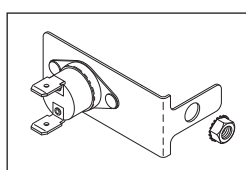

RPI Part #MIA092
OEM Part #029-3041-00, 050-5459-00 (Bracket only) & 015-1430-00 (Thermostat only)

FAN THERMOSTAT ASSEMBLY

- Material: Stainless steel bracket and hardware; 1/4" tabs
- Closes at 130°F, Opens at 101°F
- 250VAC, 0.5A

Fits: Door Frame (newer style units)
Models: M9-020 thru -022 with Serial # prefixes RN, RP, RR & V; M9D-020 thru -022 with Serial # prefixes RW, RX & V; M11-020 thru -022 with Serial # prefixes RS, RT, RV & V; and M11D-020 thru -022 with Serial # prefixes RY, RZ & V.

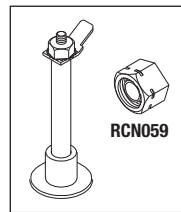

RPI Part #MIS075
OEM Part #002-0358-00

WATER LEVEL SENSOR ASSEMBLY

- Includes all parts as shown
- Also available: Water Level Sensor Harness (RPI Part #MIH136)

Fits: Chamber
Models: M9-001 thru -019, M9-020 thru -022, M9D-001 thru -019, M9D-020 thru -022, M11-001 thru -019, M11-020 thru -022, M11D-001 thru -019 & M11D-020 thru -022

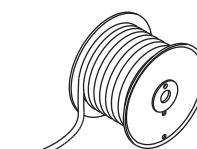

RPI Part #RPT663
OEM Part # (No OEM Part # Available)

TUBING (1/8" ID x 1/4" OD NATURAL)

- Sold by the foot; reel not included
- Material: 50 DURO natural translucent silicone
- Temperature range: -100°F to 500°F

Models: M9-001 thru -019, M9-020 thru -022, M9D-001 thru -019, M9D-020 thru -022, M11-001 thru -019, M11-020 thru -022, M11D-001 thru -019 & M11D-020 thru -022

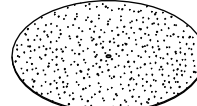

RPI Part #MIP040
OEM Part #016-0395-01

DOOR INSULATOR PAD

- Size: 10.250" OD
- Synthetic fiber with nitrile binder
- Mounts in 9" door assembly

Models: M9-001 thru -019, M9-020 thru -022, M9D-001 thru -019 & M9D-020 thru -022

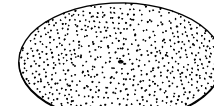

RPI Part #MIP041
OEM Part #016-0395-02

DOOR INSULATOR PAD

- Size: 12.280" OD
- Synthetic fiber with nitrile binder
- Mounts in 11" door assembly

Models: M11-001 thru -019, M11-020 thru -022, M11D-001 thru -019 & M11D-020 thru -022

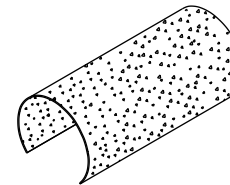

RPI Part #RPI268
OEM Part # (No OEM Part # Available)

CHAMBER INSULATION

- Size: 14-1/4" x 28" x 1/4" thk.
- White ceramic fiber paper
- Cut to fit 9" diameter chambers

Fits: Wraps around Chamber of Autoclave
Models: M9-001 thru -019, M9-020 thru -022, M9D-001 thru -019 & M9D-020 thru -022

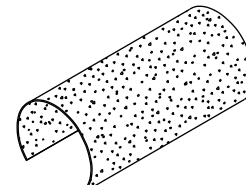

RPI Part #RPI269
OEM Part # (No OEM Part # Available)

CHAMBER INSULATION

- Size: 18-1/4" x 33-3/4" x 1/4" thk
- White ceramic fiber paper
- Cut to fit 11" diameter chambers

Fits: Wraps around chamber of autoclave
Models: M11-001 thru -019, M11-020 thru -022, M11D-001 thru -019 & M11D-020 thru -022

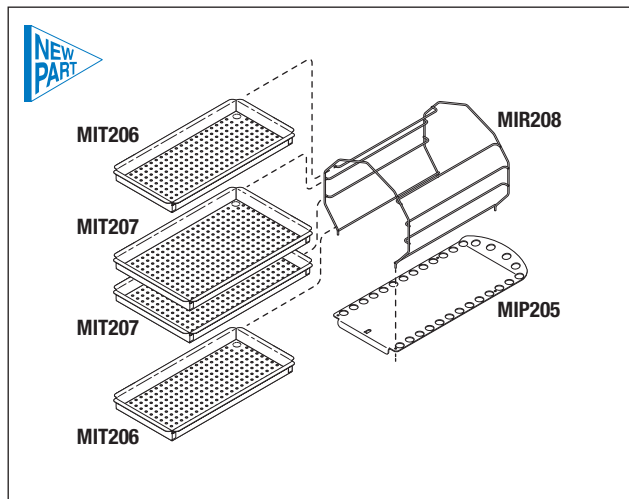

RPI Part #MIK204
OEM Part #030-0710-01 (Tray Rack), 050-3691-00 (Tray Rack), 002-0253-00 (Instrument Tray (Small)), 002-0374-00 (Instrument Tray (Large)) & 050-1773-00 (Tray Plate)

RACK AND TRAY KIT

• Includes all parts as shown; All parts also sold separately!

• Material: Stainless steel

Fits: Chamber

Models: M9-001 thru -019 & M9-020 thru -022

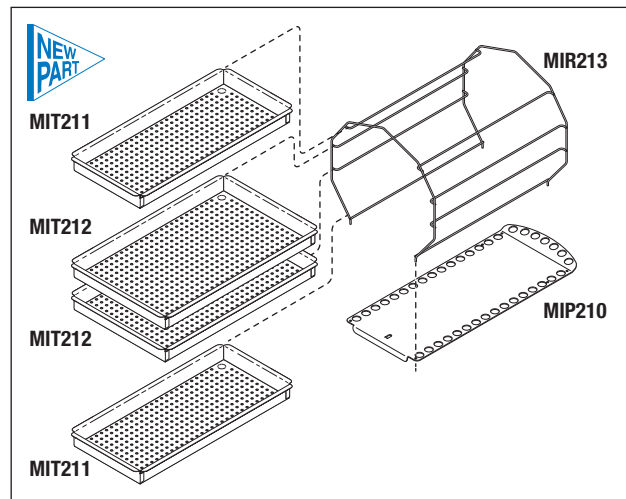

RPI Part #MIK209
OEM Part #050-3920-00 (Tray Rack), 050-2644-00 (Instrument Tray (Small)), 050-4260-00 (Instrument Tray (Small)), 050-4259-00 (Instrument Tray (Large)), 050-2643-00 (Instrument Tray (Large)) & 050-3919-00 (Tray Plate)

RACK AND TRAY KIT

• Includes all parts as shown; All parts also sold separately!

• Material: Stainless steel

Fits: Chamber

Models: M11-001 thru -019 & M11-020 thru -022



RPI Part #MIR208
OEM Part #030-0710-01 & 050-3691-00

TRAY RACK

• Material: Stainless steel

Fits: Chamber

Models: M9-001 thru -019 & M9-020 thru -022

Accommodates old and new style Instrument Trays!



RPI Part #MIR213
OEM Part #030-0887-00 & 050-3920-00 (Tray Rack)

TRAY RACK

• Material: Stainless steel

Fits: Chamber

Models: M11-001 thru -019 & M11-020 thru -022

Accommodates old and new style Instrument Trays!



RPI Part #MIT206
OEM Part #002-0253-00

INSTRUMENT TRAY (SMALL)

• Size: 6" x 12"

Fits: Tray Rack

Models: M9-001 thru -019 & M9-020 thru -022

Use with wire or sheet metal style racks!



RPI Part #MIT211
OEM Part #050-2644-00 & 050-4260-00

INSTRUMENT TRAY (SMALL)

• Size: 7" x 15"

• Does not fit older square rack Midmark Part #9A215001

Fits: Tray Rack

Models: M11-001 thru -019 & M11-020 thru -022

Use with wire or sheet metal style racks!



RPI Part #MIT207
OEM Part #002-0374-00

INSTRUMENT TRAY (LARGE)

• Size: 7" x 12"

Fits: Tray Rack

Models: M9-001 thru -019 & M9-020 thru -022

Use with wire or sheet metal style racks!



RPI Part #MIT212
OEM Part #050-2643-00 & 050-4260-00

INSTRUMENT TRAY (LARGE)

• Size: 9" x 15"

• Does not fit older square rack Midmark Part #9A215001

Fits: Tray Rack

Models: M11-001 thru -019 & M11-020 thru -022

Use with wire or sheet metal style racks!



RPI Part #MIP205
OEM Part #050-1773-00 (Old style) & 050-3750-00 (New style)

TRAY PLATE

• Material: Stainless steel

Fits: Bottom of Chamber and Tray Rack

Models: M9-001 thru -019 & M9-020 thru -022

Use with wire or sheet metal style racks!



RPI Part #MIP210
OEM Part #050-2600-00 (Old Style) & 050-3919-00 (New Style)

TRAY PLATE

• Material: Stainless steel

Fits: Bottom of Chamber and Tray Rack

Models: M11-001 thru -019 & M11-020 thru -022

Use with wire or sheet metal style racks!

Table Top Sterilizers

Models: UltraClave® M9 & M9D, M11 & M11D (continued)

RPI Part #MIK061
OEM Part # (No OEM Part # Available)

DRAIN HOSE KIT

- Includes all parts as shown
- 13" drain hose can be cut as needed for older models and it is also sold by the foot.

Fits: Reservoir

Models: M9-001 thru -019, M9D-001 thru -019, M11-001 thru -019, M11D-001 thru -019, M9-020 thru -022; Serial Numbers V2200 thru V1464209, M9D-020 thru -022; Serial Numbers V2200 thru V1464209, M11-020 thru -022; Serial Numbers V2200 thru V1479340, M11D-020 thru -022; Serial Numbers V2200 thru V1479340

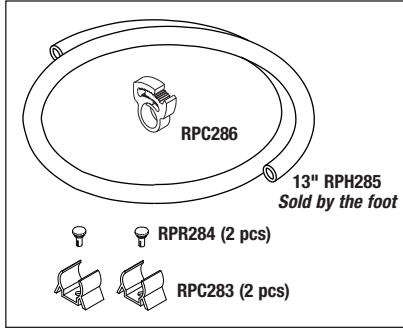

Individual parts in the Drain Hose Kit are also sold separately!

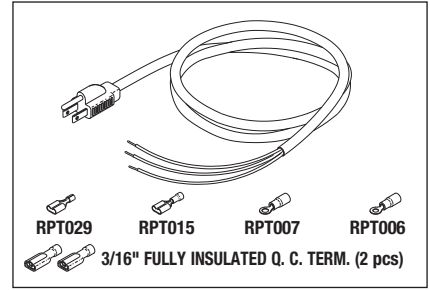

RPI Part #RPC288
OEM Part #015-1139-00

POWER CORD

- 7 ft. lg. with jacket stripped 10"
- 14/3 conductor SJT; 105°C; 15A@125VAC
- Plug: NEMA 5-15P;
- Also available: Strain Relief Bushing (RPI Part #RPB289)

Models: M9-001 thru -019, M9D-001 thru -019, M11-001 thru -019 & M11D-001 thru -019

RPI Part #RPC283
OEM Part #053-0388-01

HOSE CLIP - 5/pkg

- 11/16" dia. capacity & 1/2" wide
- Material: Black plastic
- Use Pop Rivet (RPI Part #RPR284) to mount

Fits: Reservoir Tubing

Models: M9-001 thru -019, M9D-001 thru -019, M11-001 thru -019, M11D-001 thru -019, M9-020 thru -022; Serial Numbers V2200 thru V1464209, M9D-020 thru -022; Serial Numbers V2200 thru V1464209, M11-020 thru -022; Serial Numbers V2200 thru V1479340, M11D-020 thru -022; Serial Numbers V2200 thru V1479340

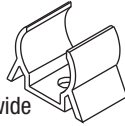

RPI Part #RPC286
OEM Part # 016-0748-01

KWIK™ CLAMP

- 6 per package
- Material: Nylon®; Color: White
- Clamping range: .688" - .812" dia.
- Temperature range: -40°F to 302°F

Fits: Reservoir Tubing

Models: M9-001 thru -019, M9-020 thru -022, M9D-001 thru -019, M9D-020 thru -022, M11-001 thru -019, M11-020 thru -022, M11D-001 thru -019 & M11D-020 thru -022



RPI Part #RPR284
OEM Part #042-0010-21

POP RIVET

- 6 per package
- Fits Hole Diameter: .122"-.126"; Holding thickness: .118"-.157"; Head: .252" dia.
- Material: Nylon 6/6; Color: Black

Fits: Holds Hose Clip to Front Panel

Models: M9-001 thru -019, M9D-001 thru -019, M11-001 thru -019, M11D-001 thru -019, M9-020 thru -022; Serial Numbers V2200 thru V1464209, M9D-020 thru -022; Serial Numbers V2200 thru V1464209, M11-020 thru -022; Serial Numbers V2200 thru V1479340, M11D-020 thru -022; Serial Numbers V2200 thru V1479340



RPI Part #RPH285
OEM Part #053-0391-01, 053-0391-02, 053-0391-03, 053-0391-06 & 053-0391-07

TUBING (3/8" ID x 5/8" OD CLEAR)

- Sold by the foot; Reel not included
- Material: Clear PVC
- Use Kwik™ Clamp (RPI Part #RPC286) to secure drain tubing

Fits: Reservoir

Models: M9-001 thru -019, M9-020 thru -022, M9D-001 thru -019, M9D-020 thru -022, M11-001 thru -019, M11-020 thru -022, M11D-001 thru -019 & M11D-020 thru -022

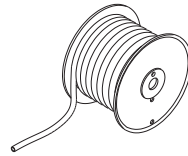

RPI Part #RPB289
OEM Part #015-1137-00

STRAIN RELIEF BUSHING

- For use with power cord (RPI Part #RPC288)
- Type SR-7P-7
- Accommodates: .360" - .430" dia. round cord
- Mounting hole: 3/4" dia.
- Also available: Strain Relief Bushing Pliers (RPI Part #RPT172)

Fits: Back Panel/Power Cord

Models: M9-001 thru -019, M9D-001 thru -019, M11-001 thru -019 & M11D-001 thru -019

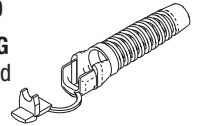

RPI Part #RPC291
OEM Part #015-0640-00

POWER CORD

- 6 ft. lg.
- 14/3 conductor SJT; 105°C; 15A@125VAC
- Plug: NEMA 5-15P
- Connector: EN60320-C13L
- Also available: Snap-In AC Receptacle (RPI Part #RPR290)

Models: M9-001 thru -019, M9-020 thru -022, M9D-001 thru -019, M9D-020 thru -022, M11-001 thru -019, M11-020 thru -022, M11D-001 thru -019 & M11D-020 thru -022

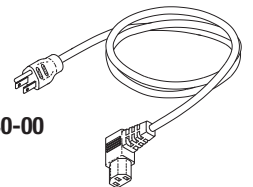

RPI Part #MIF051
OEM Part #016-0523-00

LEVELER FEET

- 4 per package
- Fits:** Bottom of base
- Models:** M9-001 thru -019, M9-020 thru -022, M9D-001 thru -019, M9D-020 thru -022, M11-001 thru -019, M11-020 thru -022, M11D-001 thru -019 & M11D-020 thru -022



RPI Part #RPT113
OEM Part #011-0012-00

MAX REGISTER THERMOMETER

- Mercury; Size: .40" OD x 6.63" lg.
- Accuracy Rating: ±1 Div. (±2°F)
- Dual scale: 150°F to 350°F / 65°C to 177°C
- Includes Metal Protective Case
- Models:** M9-001 thru -019, M9-020 thru -022, M9D-001 thru -019, M9D-020 thru -022, M11-001 thru -019, M11-020 thru -022, M11D-001 thru -019 & M11D-020 thru -022

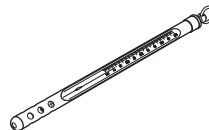

RPI Part #RPR290
OEM Part #015-0639-00

SNAP-IN AC RECEPTACLE

- For use with C13 Power Cord
- 1/4" tabs
- Panel cutout: .787" x 1.083"
- Fits:** Rear Panel
- Models:** M9-001 thru -019, M9-020 thru -022, M9D-001 thru -019, M9D-020 thru -022, M11-001 thru -019, M11-020 thru -022, M11D-001 thru -019 & M11D-020 thru -022

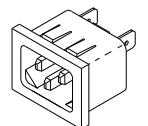

New Parts to fit

Midmark® • Ritter® UltraClave® M9 & M11 Sterilizers!



RPI Part #MIH327
OEM Part #015-1639-00

HEATER WIRE HARNESS

- Size: #14 AWG, 14.00" lg. wire, 1/4" QC terminals
- Also available: Jumper Wire (RPI Part #MIJ328) and Main Harness (RPI Part #MIH238)

Fits: PC Board to Heater (Newer Style Units Only)
Models: M9-020 thru -022, M9D-020 thru -022, M11-020 thru -022 & M11D-020 thru -022

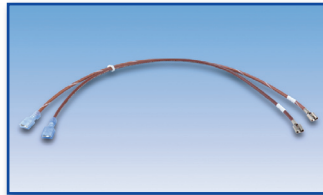

RPI Part #MIJ328
OEM Part #015-1640-00

JUMPER WIRE

- Size: #14 AWG, 2.85" lg. wire, 1/4" QC flag terminals
- Included in: Main Harness (RPI Part #MIH238)
- Also available: Heater Wire Harness (RPI Part #MIH327)

Fits: Hi Limit Thermostat to Thermostat (Newer Style Units Only)
Models: M9-020 thru -022, M9D-020 thru -022, M11-020 thru -022 & M11D-020 thru -022

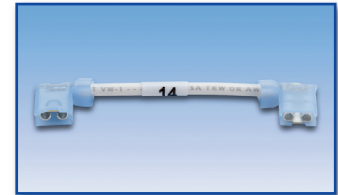

Drain Hose Kits to fit M9 & M11 Sterilizers with two different Hose Clip options!
Check Serial Numbers for which Kit you need!



Fits Newer Models

RPI Part #MIK334
OEM Part # (No OEM Part # Available)

DRAIN HOSE KIT

- 13" lg. drain hose can be cut to fit as needed.
 - Includes: (2 pcs) Hose Clip (RPI Part #MIC333), (1 pc) Kwik Clamp (RPI Part #RPC286), (13" Long) Tubing (3/8" ID x 5/8" OD Clear) (RPI Part #RPH285)
 - Also available: Drain Hose Kit (RPI Part #MIK061) for older style units
- Fits:** Reservoir to Front Panel with Hole Diameter Size: .252" thru .267" for the "Revised Hose Clip Replacement"
Models: M9/M9D (-020 thru -022 Serial #'s V1464210-Present) & M11/M11D (-020 thru -022 Serial #'s V1479341-Present)



Fits Older Models

RPI Part #MIK061
OEM Part # (No OEM Part # Available)

DRAIN HOSE KIT

- 13" lg. drain hose can be cut to fit as needed.
 - Includes: (2 pcs) Hose Clip (RPI Part #RPC283), (2 pcs) Pop Rivet (RPI Part #RPR284), (1 pc) Kwik Clamp (RPI Part #RPC286), (13" Long) Tubing (3/8" ID x 5/8" OD Clear) (RPI Part #RPH285)
 - Also available: Drain Hose Kit (RPI Part #MIK334) for newer style units
- Fits:** Reservoir to Front Panel (Older Style Units Only)
Models: M9/M9D (-001 thru -019), M11/M11D (-001 thru -019), M9/M9D (-020 thru -022 Serial #'s V2200-V1464209) & M11/M11D (-020 thru -022 Serial #'s V2200-V1479340)



The Grommet is now included in the Steam Trap Kit!

RPI Part #RXG099
OEM Part #053-0394-02

GROMMET

- 6 per package
 - Size: .250" ID x .500" OD x .250" Thk.; Groove Size: .375" dia. x .125" wide
 - Material: Black SBR Rubber, 60 Duro
- Fits:** Water Reservoir to 1/4" Copper Tubing, Groove Size: .375" dia. x .125" wide (Older Style Units Only)
Models: M9-001 thru -019, M9D-001 thru -019, M11-001 thru -019 & M11D-001 thru -019



RPI Part #MIK078
OEM Part #002-0654-00

STEAM TRAP KIT (New Style/Upgrade Kit)

- Includes: Steam Trap Valve (RPI Part #MIV081), (1 pc) Grommet (RPI Part #RXG099), (3 pcs) Compression Nut (RPI Part #RCN059), and copper tubing
- Fits:** Chamber to Condensating Tank (Older Style Units Only)
Models: M9-001 thru -019, M9D-001 thru -019, M11-001 thru -019 & M11D-001 thru -019



replacement parts industries, inc. A Healthcare Components Group Company
CALL (800) 221-9723 • FAX (818) 882-7028 • EMAIL order@rpiparts.com • WEBSITE www.rpiparts.com

The above parts are manufactured by Replacement Parts Industries, Inc. to fit the equipment noted. All product names used in this document are trademarks or registered trademarks of their respective holders. Flyer Code 1703MI Web 11/21

Make Your Midmark®·Ritter® UltraClave® Look as Good as New with RPI's Decal Labels!



RPI Part #MIK329
OEM Part #002-10231-00, 061-0311-00

DECAL KIT

- Ideal for bringing an old sterilizer back to life.
- Includes: (2 pcs) Decal (Hot Surface) (RPI Part #MID330), Decal (Distilled Water) (RPI Part #MID331), Decal (Water Level) (RPI Part #MID332), and Decal (Caution) (RPI Part #MID335)

Fits: Front and Rear Panels
Models: M9, M9D, M11, M11D

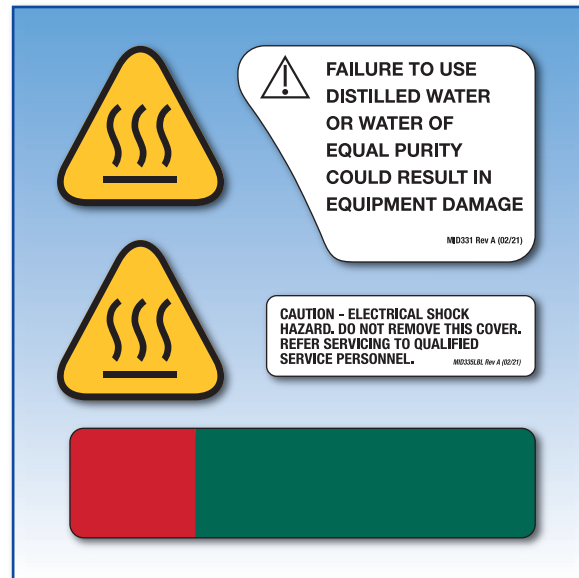

RPI Part #MID330
OEM Part #061-0726-00

DECAL (HOT SURFACE)

- 2 per package
- Size: 1.50" x 1.56"
- Included in: Decal Kit (RPI Part #MIK329)

Fits: Front Panel and Inside of Door Panel
Models: M9, M9D, M11 & M11D



RPI Part #MID331
OEM Part #061-0827-00

DECAL (DISTILLED WATER)

- Size: 2.00" x 2.75"
- Included in: Decal Kit (RPI Part #MIK329)

Fits: Front Panel
Models: M9, M9D, M11 & M11D

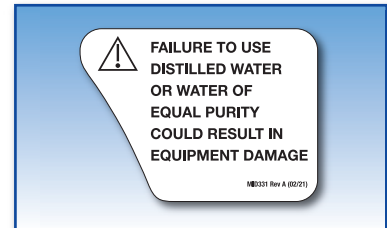

RPI Part #MID332
OEM Part #061-0311-00

DECAL (WATER LEVEL)

- Size: 1" x 4.25"
- Included in: Decal Kit (RPI Part #MIK329)

Fits: Front Panel Behind the Drain Hose
Models: M9, M9D, M11 & M11D

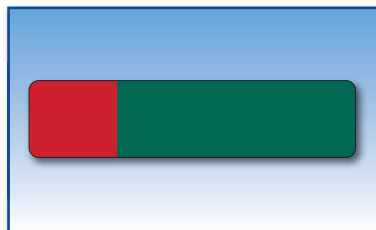

RPI Part #MID335
OEM Part #MPM60455

DECAL (CAUTION)

- Size: .75" x 1.50"
- Included in: Decal Kit (RPI Part #MIK329)

Fits: Rear Panel
Models: M9, M9D, M11 & M11D

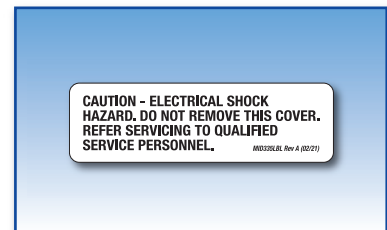

Don't Forget, RPI offers other parts you need most to fit Midmark·Ritter M9 & M11 UltraClaves including:

- | | | | |
|----------------------|--------------------------|------------------------------|--------------------------------|
| • Condensation Coils | • Door Gaskets | • Heater Element Assemblies | • Sterilizer PM Kits |
| • Control PC Boards | • Door Handles | • Rack & tray Kits | • Top Cover Kits |
| • Dam Gaskets | • Door Panel Kits | • Solenoid Valves | • Water Level Sensor Harnesses |
| • Display Assemblies | • Fill/Vent Manifold Kit | • Solenoid Valve Repair Kits | • Many more! |

Control PC Boards to fit Old & New Style Midmark® • Ritter® UltraClave® M9 & M11 sterilizers!

Fits New Style M9 & M11

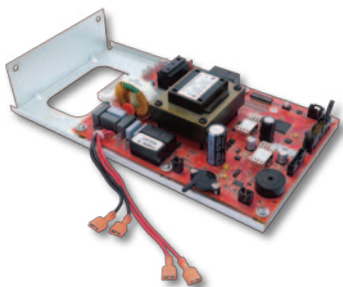

RPI Part #MIB129
OEM Part #002-1992-00

CONTROL PC BOARD (REFURBISHED)

- Includes: Mounting Bracket
- Please Note: When shipping RPI your non-operational PC Board, **you must** include the Mounting Bracket in order to receive full credit!

Fits: Chassis

Models: M9 -020 & -022 Serial # V1697650 thru Present; and M11 -020 & -022 Serial # V1697650 thru Present

Fits New Style M9 & M11

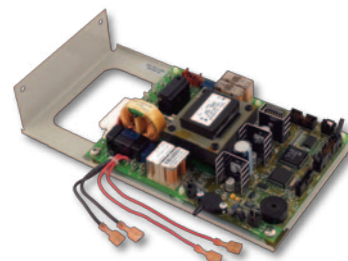

RPI Part #MIB129
OEM Part #022-0762-00

CONTROL PC BOARD (REFURBISHED)

- Includes: Mounting Bracket
- Please Note: When shipping RPI your non-operational PC Board, **you must** include the Mounting Bracket in order to receive full credit!

Fits: Chassis

Models: M9 -020 & -022 Serial # prefixes RN, RR & Serial # V2200 thru V1697649; and M11 -020 & -022 Serial # prefixes RS, RV & Serial # V2200 thru V1697649

Fits Old Style M9

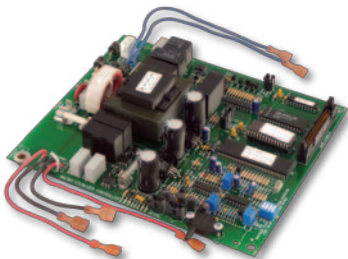

RPI Part #MIB130
OEM Part #002-0434-00/
002-0434-03

CONTROL PC BOARD (REFURBISHED)

- Mounting Bracket not included
- Please Note: This PC Board **Does Not** include the Mounting Bracket. When shipping your non-operation PC Board to RPI, do not include your Mounting Bracket. You will need your Mounting Bracket to install the refurbished PC Board!

Fits: Chassis

Models: M9 -001 thru -019 with Serial # prefixes CZ, DA, DB, DX, DY, FD & OM

Fits Old Style M11

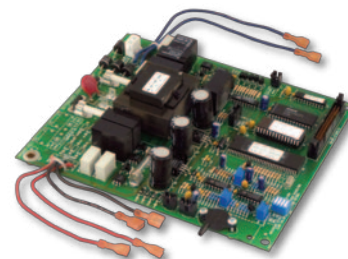

RPI Part #MIB131
OEM Part #002-0501-00

CONTROL PC BOARD (REFURBISHED)

- Mounting Bracket not included
- Please Note: This PC Board **Does Not** include the Mounting Bracket. When shipping your non-operation PC Board to RPI, do not include your Mounting Bracket. You will need your Mounting Bracket to install the refurbished PC Board!

Fits: Chassis

Models: M11 -001 thru -019 with Serial # prefixes ES, ET, FP, FR & GB

About RPI's Control PC Board Exchange Program

Here's How the \$100 Credit Exchange Program Works.

- 1) Place an order for a Control PC Board (PCB), and RPI will send a shipping box and prepaid UPS return label to you. You will not pay for shipping when using this box.
- 2) Using the shipping box and UPS return label, ship as follows:
 - **Include** the PCB and Mounting Bracket if shipping the *New Style* M9/M11 PCB (OEM Part #002-1992-00/022-0762-00). If you do not Include the Mounting Bracket, you will only receive a \$75 Credit instead of \$100.
 - **Do not include** the Mounting Bracket if shipping the *Old Style* M9/M11 PCB (OEM Part #'s 002-0434-00/002-0434-03/002-0501-00).
- 3) Once the non-operational board has been received by RPI and verified that it is in reasonable condition without burn holes, a replacement PCB will be shipped to you. Your invoice will reflect the cost of the board plus the \$100 credit for the Core.

Important Information. PC Board performance verified and tested and Quality Control test printout is included with each PC Board. 90 Day Warranty.

Warning. To avoid damaging the replacement PC Board and possibly voiding the warranty, check the condition of the *Heater and/or Pulse Solenoid* prior to installing the replacement PC Board. DO NOT use PC Board in 220V or version "D" sterilizers.



You asked for It ... RPI Now Offers the Red Colored PC Board to fit newer Midmark • Ritter UltraClave M9 & M11 sterilizers with a Green LCD Display!

RPI now offers the **red colored PC Boards** that fit the newer Midmark sterilizers with a green display through our PC Board Exchange Program - receive a \$100* credit with the bracket, and \$75.00* without the bracket. These boards fit the M9 -020 thru -022 Serial # V1697650 thru Present and the M11 -020 thru -022 Serial # V1697650 thru Present. Just ask for the Control PC Board (RPI Part #MIB132).

Don't forget, we already have a program for the **green colored PC Boards** that also fit newer Midmark sterilizers with a green display. This PCB fits the M9 -020 thru -022 with serial number prefixes RN, RR, and Serial # V2200 thru V1697649; and the M11 -020 thru -022 with serial number prefixes RS, RV, and Serial # V2200 thru V1697649. Just ask for RPI Part #MIB129. Also note that both the red and green boards will only be exchanged for the exact same style board - red for red, and green for green - this is the only way in which we can keep this program working.

* Credit is given after RPI has inspected the PC Board and found it to be in good condition.

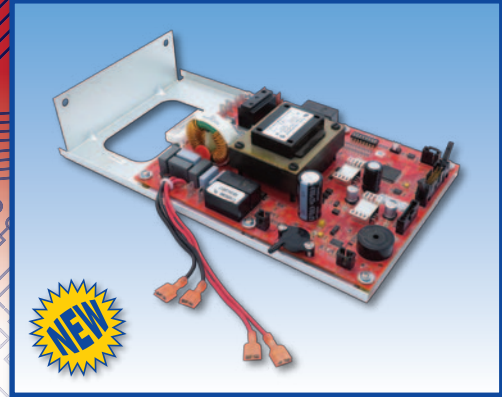

RPI Part #MIB132

PC Boards to fit Midmark® • Ritter® UltraClave® M9 & M11 Sterilizers!

ADDRESS SERVICES REQUESTED

replacement parts industries, inc.
 625 Cochran Street • Simi Valley, California • 93065



PERMITTED STANDARD
 U.S. POSTAGE PAID
 VAN NUYS, CA
 PERMIT NO. 2399

RPI now offers four Control PC Boards to fit Midmark® • Ritter® UltraClave® M9 & M11 Sterilizers!

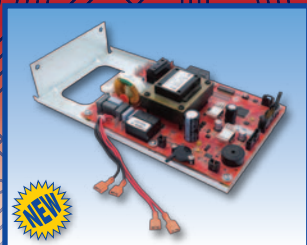

RPI Part #MIB132
 Fits new style
M9 & M11

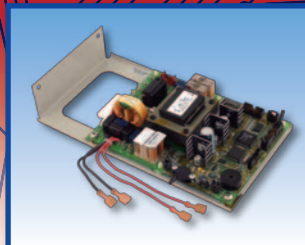

RPI Part #MIB129
 Fits new style
M9 & M11

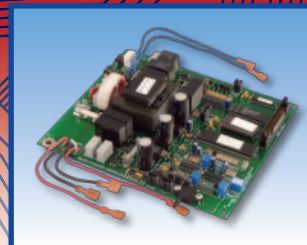

RPI Part #MIB130
 Fits old style
M9

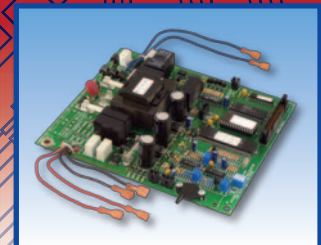

RPI Part #MIB131
 Fits old style
M11



... Proud to be a Healthcare Components Group brand ...



HEALTHCARE
Components Group

MIDMARK • RITTER

We've Got You Covered ... New Parts to fit

MIDMARK® • RITTER® ULTRACLAVE® M9 & M11 STERILIZERS!

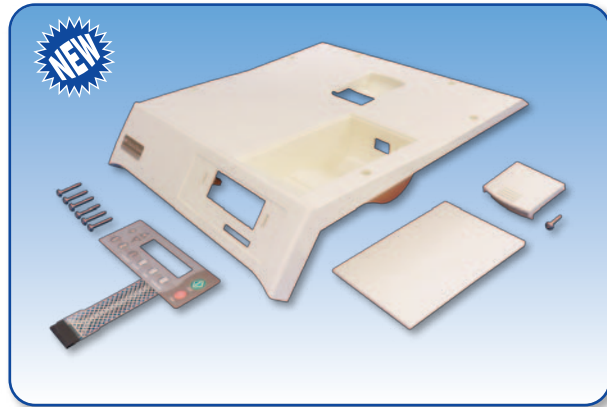

RPI Part #MIK267
**OEM Part #002-0782-00/002-0782-01/
002-0782-02/002-0782-03**

TOP COVER KIT

- Includes: Touch Pad (RPI Part #MIP099), Pressure Relief Handle (RPI Part #MIH269), Cover Plate (Printer) (RPI Part #MIC270) and (6 pcs) Screw (#10 x 1-1/4" Phillips Pan Head) (RPI Part #RPH851)
- Also available: Steam Block Kit (RPI Part #MIK236), Display Assembly (RPI Part #MIA147), Hinge Cover (RPI Part #MIC271) and Speednut (RPI Part #PCN136)

Fits: Top of Sterilizer

Models: M9-020 thru -022 and M9D-020 thru -022

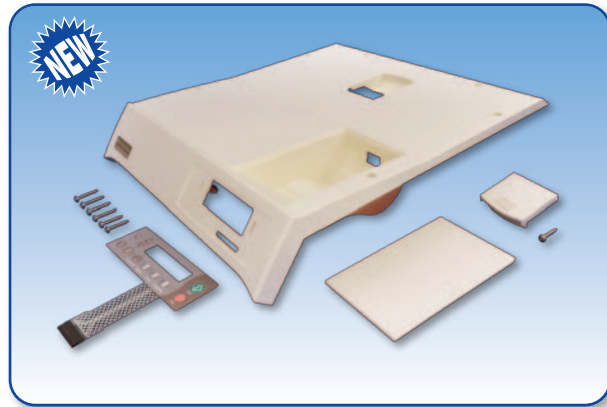

RPI Part #MIK268
OEM Part # 002-0780-00/002-0780-01

TOP COVER KIT

- Includes: Touch Pad (RPI Part #MIP099), Pressure Relief Handle (RPI Part #MIH269), Cover Plate (Printer) (RPI Part #MIC270) and (6 pcs) Screw (#10 x 1-1/4" Phillips Pan Head) (RPI Part #RPH851)
- Also available: Steam Block Kit (RPI Part #MIK237), Display Assembly (RPI Part #MIA147), Hinge Cover (RPI Part #MIC271) and Speednut (RPI Part #PCN136)

Fits: Top of Sterilizer

Models: M11-020 thru -022 & M11D-020 thru -022



RPI Part #MIK265
**OEM Part #002-0783-00/
002-0783-01/
053-1251-00**

DOOR PANEL KIT

- Includes: Door Handle (RPI Part #MIH163), Hinge Cover (RPI Part #MIC271) and (4 pcs) Screw (#8 x 7/8" Phillips Pan Head) (RPI Part #RPH855) - *It's the RPI Advantage!*
- Also available: Steam Block Kit (RPI Part #MIK236)

Fits: Door Frame

Models: M9-020 thru -022 & M9D-020 thru -022

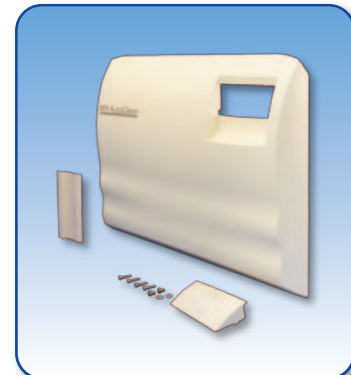

RPI Part #MIK266
**OEM Part #002-0781-00/
002-0781-01/
053-1255-00**

DOOR PANEL KIT

- Includes: Door Handle (RPI Part #MIH163), Hinge Cover (RPI Part #MIC271) and (4 pcs) Screw (#8 x 7/8" Phillips Pan Head) (RPI Part #RPH855) - *It's the RPI Advantage!*
- Also available: Steam Block Kit (RPI Part #MIK237)

Fits: Door Frame

Models: M11-020 thru -022 & M11D-020 thru -022



replacement parts industries, inc. Add this page to your RPI catalog – Section 10, Page 1026

CALL (800) 221-9723 • FAX (818) 882-7028 • EMAIL order@ripiparts.com • WEBSITE www.ripiparts.com

The above parts are manufactured by Replacement Parts Industries, Inc. to fit the equipment noted. All product names used in this document are trademarks or registered trademarks of their respective holders. Flyer Code 1703MI RD2 Web 08/22

SECTION
10

PAGE
1026

UPDATED
08/22

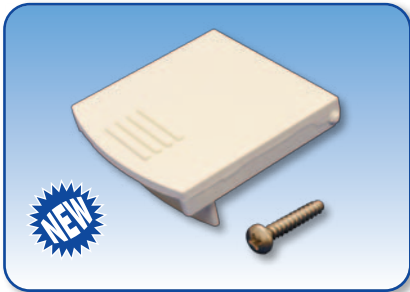

RPI Part #MIH269
OEM Part #053-1252-00

PRESSURE RELIEF HANDLE

- Includes: (1 pc) Screw (#10 x 1-1/4" Phillips Pan Head) (RPI Part #RPH851)
- Included in: Top Cover Kit (RPI Part #'s MIK267 & MIK268)
- Also available: Safety Valve (40 PSI) (RPI Part #'s MIV122 & MIV090)

Fits: Top Cover to Safety Valve
Models: M9-020 thru -022, M9D-020 thru -022, M11-020 thru -022 & M11D-020 thru -022



RPI Part #MIC271
OEM Part #053-1277-00

HINGE COVER

- Included in: Door Panel Kit (RPI Part #'s MIK265 & MIK266)

Fits: Hinge Assembly
Models: M9-020 thru -022, M9D-020 thru -022, M11-020 thru -022 & M11D-020 thru -022

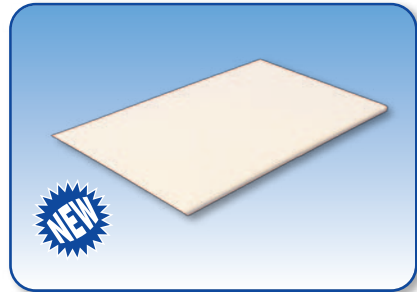

RPI Part #MIC270
OEM Part #053-0933-00

COVER PLATE (PRINTER)

- Included in: Top Cover Kit (RPI Part #'s MIK267 & MIK268)

Fits: Top Cover
Models: M9-020 thru -022, M9D-020 thru -022, M11-020 thru -022 & M11D-020 thru -022

Make Your Midmark •Ritter® UltraClave® Look as Good as New with RPI's Decals!

RPI Part #MIK329
OEM Part #002-10231-00/061-0311-00

DECAL KIT

- Ideal for bringing an old sterilizer back to life.
- Includes: (2 pcs) Decal (Hot Surface) (RPI Part #MID330), Decal (Distilled Water) (RPI Part #MID331), Decal (Water Level) (RPI Part #MID332), and Decal (Caution) (RPI Part #MID335)

Fits: Front and Rear Panels
Models: M9, M9D, M11, M11D

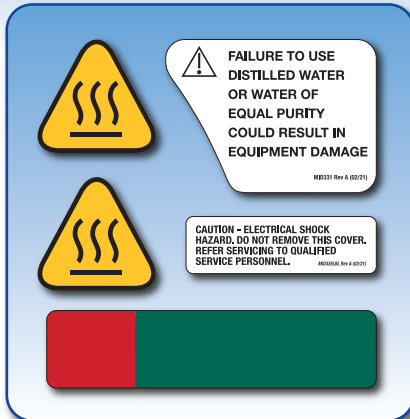

RPI Part #MID330
OEM Part #061-0726-00

DECAL (HOT SURFACE)

- 2 per package
- Size: 1.50" x 1.56"
- Included in: Decal Kit (RPI Part #MIK329)

Fits: Front Panel and Inside of Door Panel
Models: M9, M9D, M11 & M11D



RPI Part #MID331
OEM Part #061-0827-00

DECAL (DISTILLED WATER)

- Size: 2.00" x 2.75"
- Included in: Decal Kit (RPI Part #MIK329)

Fits: Front Panel
Models: M9, M9D, M11 & M11D

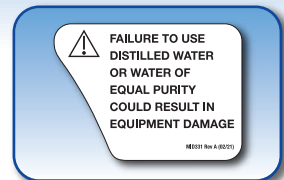

RPI Part #MID332
OEM Part #061-0311-00

DECAL (WATER LEVEL)

- Size: 1" x 4.25"
- Included in: Decal Kit (RPI Part #MIK329)

Fits: Front Panel Behind the Drain Hose
Models: M9, M9D, M11 & M11D



RPI Part #MID335
OEM Part #MPM60455

DECAL (CAUTION)

- Size: .75" x 1.50"
- Included in: Decal Kit (RPI Part #MIK329)

Fits: Rear Panel
Models: M9, M9D, M11 & M11D

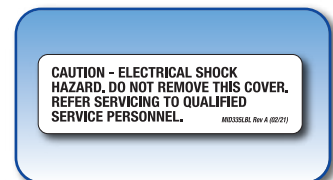

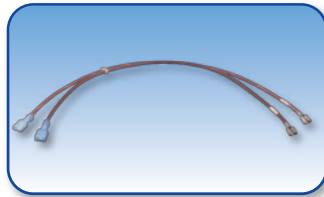

RPI Part #MIH327
OEM Part #015-1639-00

HEATER WIRE HARNESS

- Size: #14 AWG, 14.00" lg. wire, 1/4" QC terminals, with wire marker #11 and #12
- Also available: Jumper Wire (RPI Part #MIJ328) and Main Harness (RPI Part #MIH238)

Fits: PC Board to Heater (Newer Style Units Only)

Models: M9-020 thru -022, M9D-020 thru -022, M11-020 thru -022 & M11D-020 thru -022

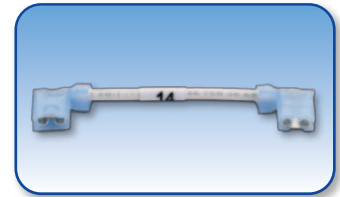

RPI Part #MIJ328
OEM Part #015-1640-00

JUMPER WIRE

- Size: #14 AWG, 2.85" lg. wire, 1/4" QC flag terminals, with wire marker #14
 - Included in: Main Harness (RPI Part #MIH238)
 - Also available: Heater Wire Harness (RPI Part #MIH327)
- Fits:** Hi Limit Thermostat to Thermostat (Newer Style Units Only)
- Models:** M9-020 thru -022, M9D-020 thru -022, M11-020 thru -022 & M11D-020 thru -022

The Grommet is now included in the Steam Trap Kit!



RPI Part #RXG099
OEM Part #053-0394-02

GROMMET

- 6 per package
- Size: .250" ID x .500" OD x .250" Thk.; Groove Size: .375" dia. x .125" wide
- Material: Black SBR Rubber, 60 Duro

Fits: Water Reservoir to 1/4" Copper Tubing, Groove Size: .375" dia. x .125" wide (Older Style Units Only)

Models: M9-001 thru -019, M9D-001 thru -019, M11-001 thru -019 & M11D-001 thru -019



RPI Part #MIK078
OEM Part #002-0654-00

STEAM TRAP KIT (New Style/Upgrade Kit)

- Includes: Steam Trap Valve (RPI Part #MIV081), (1 pc) Grommet (RPI Part #RXG099), (3 pcs) Compression Nut (RPI Part #RCN059), and copper tubing
- Fits:** Chamber to Condensating Tank (Older Style Units Only)
- Models:** M9-001 thru -019, M9D-001 thru -019, M11-001 thru -019 & M11D-001 thru -019

Drain Hose Kits to fit M9 & M11 Sterilizers with two different Hose Clip options!

Check Serial Numbers for which Kit you need!

Fits Newer Models



RPI Part #MIC333
OEM Part #015-1695-00

HOSE CLIP

- 2 per package
- Size: 11/16" diameter capacity, 1/2" wide, black plastic
- Fits mounting hole size: .252" thru .267" dia.
- Included in: Drain Hose Kit (RPI Part #MIK334)

Fits: Reservoir Drain Tubing to Front Panel (Newer Style Units Only)

Models: M9/M9D (-020 thru -022 Serial #'s V1464210-Present) & M11/M11D (-020 thru -022 Serial #'s V1479341-Present)

Fits Newer Models

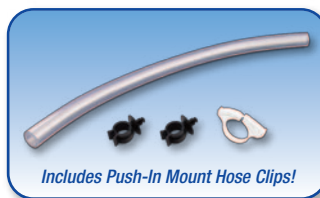

Includes Push-In Mount Hose Clips!

RPI Part #MIK334
OEM Part # (No OEM Part # Available)

DRAIN HOSE KIT

- 13" lg. drain hose can be cut to fit as needed.
- Includes: (2 pcs) Hose Clip (RPI Part #MIC333), (1 pc) Kwik Clamp (RPI Part #RPC286), (13" Long) Tubing (3/8" ID x 5/8" OD Clear) (RPI Part #RPH285)
- Also available: Drain Hose Kit (RPI Part #MIK061) for older style units

Fits: Reservoir to Front Panel with Hole Diameter Size: .252" thru .267" for the "Revised Hose Clip Replacement"

Models: M9/M9D (-020 thru -022 Serial #'s V1464210-Present) & M11/M11D (-020 thru -022 Serial #'s V1479341-Present)

Fits Older Models



Includes Rivot Mount Hose Clips!

RPI Part #MIK061
OEM Part # (No OEM Part # Available)

DRAIN HOSE KIT

- 13" lg. drain hose can be cut to fit as needed.
- Includes: (2 pcs) Hose Clip (RPI Part #RPC283), (2 pcs) Pop Rivet (RPI Part #RPR284), (1 pc) Kwik Clamp (RPI Part #RPC286), (13" Long) Tubing (3/8" ID x 5/8" OD Clear) (RPI Part #RPH285)
- Also available: Drain Hose Kit (RPI Part #MIK334) for newer style units

Fits: Reservoir to Front Panel with Hole Diameter Size: .122" thru .126" (Older Style Units Only)

Models: M9/M9D (-001 thru -019), M11/M11D (-001 thru -019), M9/M9D (-020 thru -022 Serial #'s V2200-V1464209) & M11/M11D (-020 thru -022 Serial #'s V2200-V1479340)



... Proud to be a **Healthcare Components Group** company ...



**HEALTHCARE
Components Group**

MIDMARK • RITTER



New Autoclave Data Loggers to fit Midmark® • Ritter® M9 & M11

Automatic • Wireless • Paperless

Securely store autoclave cycle data to the cloud and on a removable SD card and eliminate the need for printing.

Features

- Wireless Data Recorder with LCD Display
- Removeable 16gb micro SD card
- Secure Wi-Fi
- Password protected
- FCC Certified
- Unique naming of each autoclave
- 5 year time and date battery
- Automatic time keeping and daylight savings time adjustment
- Wireless upload to offsite Dropbox™ cloud storage



**RPI Part #MIL337
OEM Part #9A682001**



DATA LOGGER (M19)

- The Autoclave Logger Thing M19
- Size: 2-1/2" x 4" x 1"
- Includes: Removable 16gb micro SD card, SD card adaptor, stand, cable, and user/setup manual.

Fits: Autoclave

Models: M9-001 thru -019 & M11-001 thru -019



**RPI Part #MIL338
OEM Part #9A682001**



DATA LOGGER (M22)

- Autoclave Logger Thing M22
- Size: 2-1/2" x 4" x 1"
- Includes: Removable 16gb micro SD card, SD card adaptor, stand, cable, user/setup manual, and drill template for use with printer cover plate.

Fits: Autoclave

Models: M9-020 thru -022 & M11-020 thru -022



**RPI Part #MIL340
OEM Part #9A682001**



DATA LOGGER (M42)

- Autoclave Logger Thing M42
- Size: 2-1/2" x 4" x 1"
- Includes: Removable 16gb micro SD card, SD card adaptor, stand, cable, user/setup manual, and drill template for use with printer cover plate.

Fits: Autoclave

Models: M9-040 thru -043 & M11-040 thru -043



replacement parts industries, inc. A Healthcare Components Group Company

CALL (800) 221-9723 • FAX (818) 882-7028 • EMAIL order@rpiparts.com • WEBSITE www.rpiparts.com

The above parts are manufactured by Replacement Parts Industries, Inc. to fit the equipment noted. All product names used in this document are trademarks or registered trademarks of their respective holders. 2104DL Web 01/23

SECTION

10

PAGE

1027

UPDATED

01/23

RPI Part #NAG001
OEM Part #51245078

DOOR GASKET (QUAD RING)

• 10.000" OD x .281" Sq. C/S

Fits: Door

Model: 704-9000

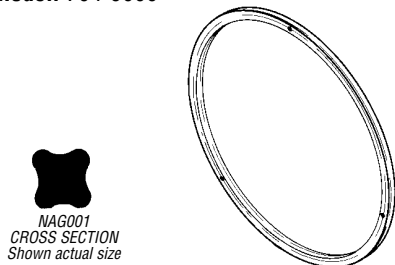

NAG001
CROSS SECTION
Shown actual size

RPI Part #NAG002
OEM Part #34002877

DOOR GASKET (QUAD RING)

• 6.500" OD x .187" Sq. C/S

Fits: Door

Model: 704-7000

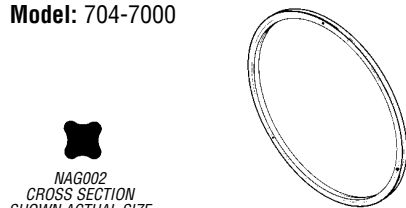

NAG002
CROSS SECTION
SHOWN ACTUAL SIZE

RPI Part #NAH003
OEM Part #51245045

HEATING ELEMENT

• 1250 W, 120 VAC, ~11.5Ω

• Includes all parts as shown

• Mounts in water pan

Fits: Main Element for Models 704-7000
Drying/Top Element for Model 704-9000

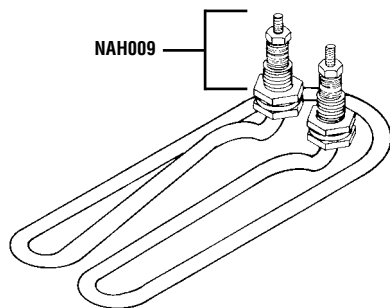

RPI Part #NAH004
OEM Part #51245043

HEATING ELEMENT

• 1400 W, 120 VAC, ~10Ω

• Includes all parts as shown

• Mounts in water pan

Fits: Main Element for Models 704-8000
& 704-9000

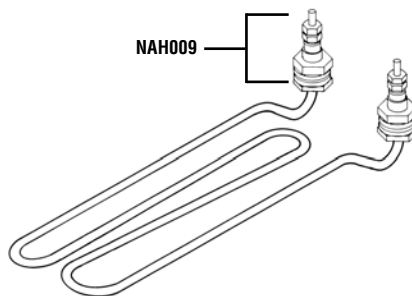

RPI Part #NAH009

OEM Part # (No OEM Part # Available)

HARDWARE KIT

• Includes (2x) all parts as shown

Fits: Heating Elements (RPI Part #NAH003
& NAH004)

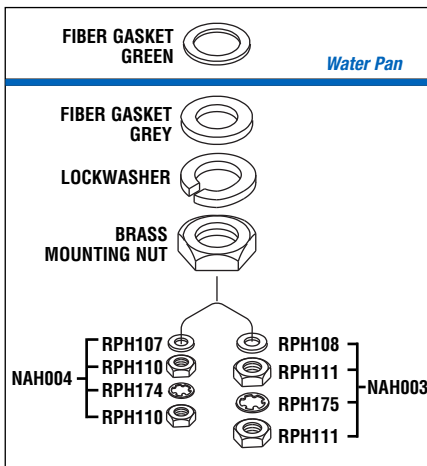

DON'T FORGET!

RPI Part #RPA032

THREADLOCKER 242

- 5 per package
- .02 fl.oz. per tube
- Prevents rust and corrosion
- Removable adhesive by Loctite®



RPI Part #NAL005
OEM Part #34001268

PILOT LIGHT ASSEMBLY

• 120 VAC, 1/3 W

• Includes lamp with leads, and crimp on connectors

• Mounts in Control Panel

• Lens: Red

Models: 704-7000 & 704-9000

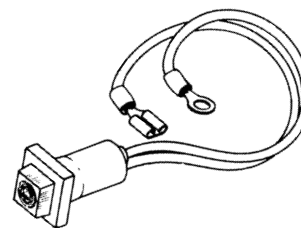

RPI Part #NAS006
OEM Part #34239187

LOW WATER CUT-OFF SWITCH

• Opens @ 300°F, Closes @ 220°F

• Mounts on chamber

Models: 704-7000, 704-8000 & 704-9000

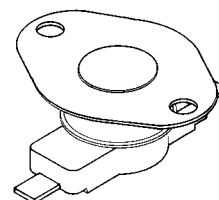

RPI Part #NAV007
OEM Part #3114-098

SAFETY VALVE (35 PSI)

• Cracking Pressure: 35 PSI, 1/8" MPT

• Mounts to bulkhead female connector assembly

Model: 704-7000

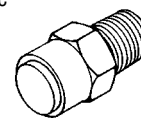

RPI Part #NAV008
New OEM Part #34269116
Old OEM Part #3114-097

SAFETY VALVE (35 PSI)

• Cracking Pressure: 35 PSI, 1/4" MPT

• With deflector cap

• Mounts to bulkhead female connector assembly

Model: 704-9000

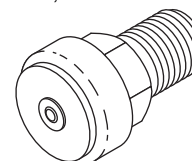

RPI Part #PCG065
New OEM Part #1539241
Old OEM Part #019613

DOOR GASKET
• 9.875" OD
Fits: Door
Model: AE8, XL8 & Q8

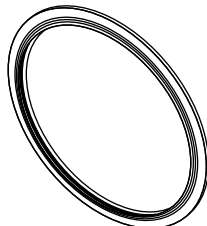

REPLACE THE DOOR SPACER AT THE SAME TIME!
ASK FOR RPI PART #PCS067



RPI Part #PCK231
OEM Part #1539241 (Door Gasket only)

STERILIZER PM KIT

- Includes:
 - Compressor Filter (RPI Part #SCF002),
 - Door Gasket (RPI Part #PCG065),
 - Filter (Fill Line) (RPI Part #PCF009),
 - Filter - In-Line Assembly (RPI Part #PCF233),
 - HEPA Filter (RPI Part #RPF644),
 - Reservoir Filter Kit (RPI Part #PCK167),
 - Spacer (Door) (RPI Part #PCS067),
 - Installation Check List

Model: AE8, XL8 & Q8

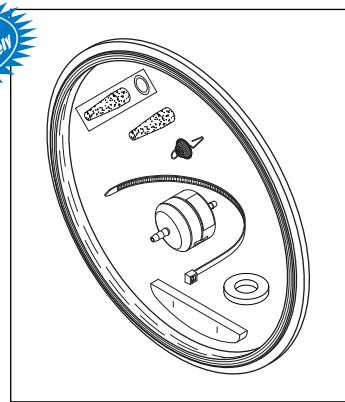

RPI Part #PCG066
New OEM Part #1539407
Old OEM Part #019763

DOOR GASKET
• 11.312" OD
Fits: Door
Model: AF10, XL10 & Q10

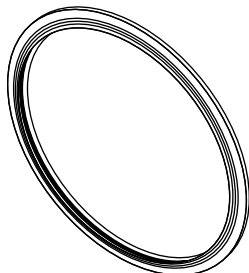

REPLACE THE DOOR SPACER AT THE SAME TIME!
ASK FOR RPI PART #PCS067



RPI Part #PCK232
OEM Part #1539407 (Door Gasket only)

STERILIZER PM KIT

- Includes:
 - Compressor Filter (RPI Part #SCF002),
 - Door Gasket (RPI Part #PCG066),
 - Filter (Fill Line) (RPI Part #PCF009),
 - Filter - In-Line Assembly (RPI Part #PCF233),
 - HEPA Filter (RPI Part #RPF644),
 - Reservoir Filter Kit (RPI Part #PCK167),
 - Spacer (Door) (RPI Part #PCS067),
 - Installation Check List

Model: AF10, XL10 & Q10

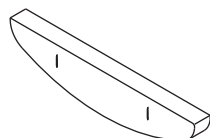
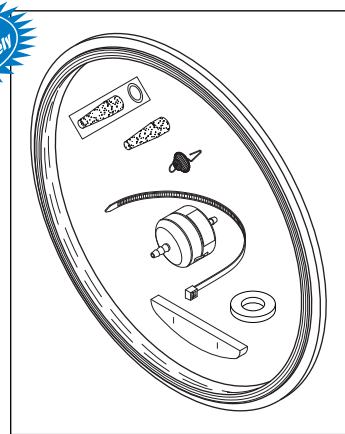

RPI Part #PCS067
New OEM Part #3322281
Old OEM Part #019678

SPACER (DOOR)
• With "slots" for easy installation
Fits: Door
Model: AE8, XL8, Q8, AF10, XL10 & Q10

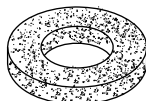

RPI Part #SCF002
OEM Part # (No OEM Part # Available)

COMPRESSOR FILTER
• 1.080" ID x 2.080" OD x .310" thk
• Polyethylene/Polyurethane Foam
• 40 micron rating
• Use with Pump (115VAC)
(RPI Part #PCP228/ OEM Part #3325086)
Fits: Pump
Model: AE8, XL8, Q8, AF10, XL10 & Q10

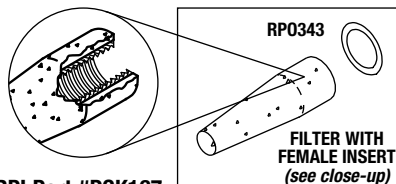

RPI Part #PCK167
OEM Part #9432311

RESERVOIR FILTER KIT

- Includes all parts as shown
- 120-150 micron filter with 3/8-24 female insert
- Fits: Fill Coupling Vent/Condenser
- Model: AE8, XL8, Q8, AF10, XL10 & Q10



RPI Part #PCF233
OEM Part #040978

FILTER IN-LINE ASSEMBLY

- Material: 100 x 100 mesh Stainless Steel screen with wire retainer
- Fits: Inner Chamber Port
- Model: AE8, XL8, Q8, AF10, XL10 & Q10

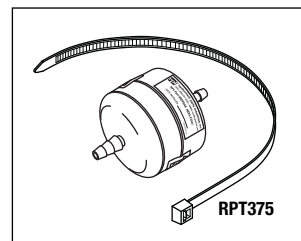

RPI Part #RPF644
OEM Part #4197146

HEPA FILTER

- ~ 2.5" lg.
- Accommodates tubing with ID of 1/4" - 3/8"
- For use with air or gasses only
- Includes all parts as shown
- Fits: Water Reservoir/Filter Cover
- Model: AE8, XL8, Q8, AF10, XL10 & Q10

RPI Part #PCF009
New OEM Part #1881031
Old OEM Part #004326

FILTER (FILL LINE)

- 120 - 150 micron
- Fits: Fill Chamber Tube
- Model: AE8, XL8, Q8, AF10, XL10 & Q10

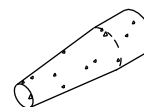

Table Top Sterilizers

Models: Delta AE8, XL8, Q8, AF10, XL10 & Q10 (continued)

Service Tip

To avoid damaging the autoclave, use the Spanner Nut (RPI Part #ILS014) and the Double Ended Spanner Wrench (RPI Part #RPT501) when replacing the Fill/Vent Plunger Kit (RPI Part #PCK202), Dump Plunger Kit (RPI Part #PCK203) and Bellows Plunger Kit (RPI Part #PCK204).

RPI Part #ILS014
OEM Part #026169

SPANNER NUT

- .525" ID x .875" HEX x .250" thk
- Material: Stainless Steel
- See "Service Tip"

Fits: Fill, Dump & Vent Solenoid Valves

Model: AE8, XL8, Q8, AF10, XL10 & Q10

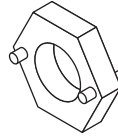

RPI Part #RPT501
OEM Part # (No OEM Part # Available)

DOUBLE ENDED SPANNER WRENCH

- .875" HEX x ~7" lg.
- Material: Stainless steel
- See "Service Tip"

Fits: 5/8" and 3/4" spanner nuts

Model: AE8, XL8, Q8, AF10, XL10 & Q10

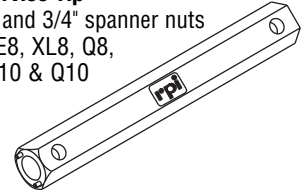

RPI Part #PCK202
OEM Part #5151787/
9442922-V

FILL/VENT PLUNGER KIT

- Includes all parts as shown
- See "Service Tip" above
- Fits:** Fill/Vent solenoid valve
- Model:** AE8, XL8, Q8, AF10, XL10 & Q10

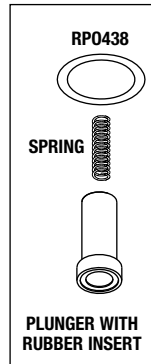

RPI Part #PCK203
OEM Part #5151803/
9442930-V

DUMP PLUNGER KIT

- Includes all parts as shown
- See "Service Tip" above
- Fits:** Dump solenoid valve
- Model:** AE8, XL8, Q8, AF10, XL10 & Q10

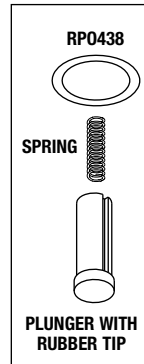

RPI Part #PCK204
OEM Part #5151795/
9442948-V

BELLOWS PLUNGER KIT

- Includes all parts as shown
- See "Service Tip" above
- Fits:** Bellows solenoid valve
- Model:** AE8, XL8, Q8, AF10, XL10 & Q10

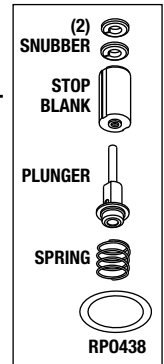

RPI Part #PCN136
OEM Part #004076

SPEEDNUT

- 10 per package
- "U" type #10-24 thread
- Model:** AE8, XL8, Q8, AF10, XL10 & Q10



RPI Part #PCT010
New OEM Part #1881023
Old OEM Part #004371

FILL CHAMBER TUBE

- Fits:** Fill Filter and Chamber
- Model:** AE8, XL8, Q8, AF10, XL10 & Q10

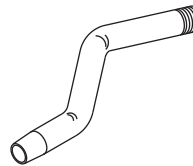

RPI Part #PCT142
OEM Part #1539357

INSTRUMENT TRAY (SMALL)

- Stainless steel
- 6-1/2" x 17" x 1"
- Tray can be used with larger tray (RPI Part #PCT143)
- Fits:** Chamber
- Model:** AF10, XL10 & Q10

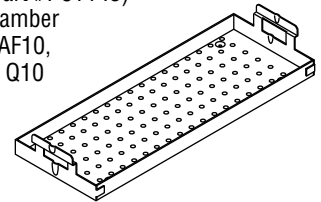

RPI Part #PCS170
OEM Part #1539936

BLACK COVER SCREW

- 12 per package
- #10-24 x 3/8" lg.
- Stainless steel with black zinc plating
- Fits:** Outer cover
- Model:** AE8, XL8, Q8, AF10, XL10 & Q10

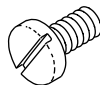

RPI Part #PCK225
OEM Part #004439

FILTER AND TUBE KIT

- Includes all parts as shown
- Model:** AE8, XL8, Q8, AF10, XL10 & Q10

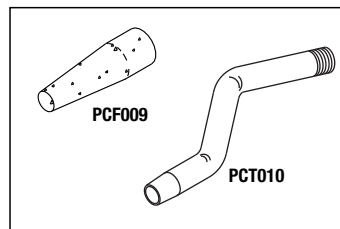

ALL PARTS IN KIT, ALSO SOLD SEPARATELY.

RPI Part #PCT143
New OEM Part #1539340
Old OEM Part #044159

INSTRUMENT TRAY (LARGE)

- Stainless steel
- 8" x 17" x 2-1/2"
- Tray can be used with smaller tray (RPI Part #PCT142)
- Fits:** Chamber
- Model:** AF10, XL10 & Q10

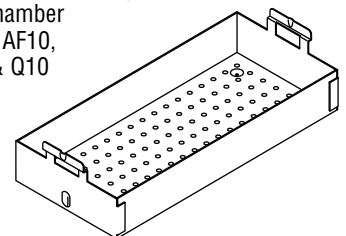
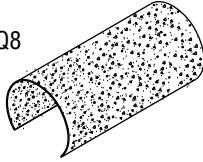

Table Top Sterilizers

Models: Delta AE8, XL8, Q8, AF10, XL10 & Q10

RPI Part #RPI268
OEM Part # (No OEM Part # Available)

CHAMBER INSULATION
 • 14-1/4" x 28" x 1/4" thk
 • White ceramic fiber paper
 • Cut to fit 8" dia. chambers
Fits: Wraps around chamber of autoclave
Model: AE8, XL8 & Q8



RPI Part #RPI269
OEM Part # (No OEM Part # Available)

CHAMBER INSULATION
 • 18-1/4" x 33-3/4" x 1/4" thk
 • White ceramic fiber paper
 • Cut to fit 10" dia. chambers
Fits: Wraps around chamber of autoclave
Model: AF10, XL10 & Q10

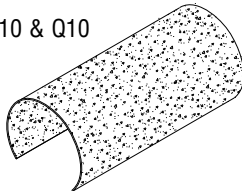

RPI Part #PCP200
New OEM Part #1539514
Old OEM Part #0211812

INSULATION PAD
 • Ceramic fiber paper (white)
Fits: Between gasket retainer and door body
Model: AE8, XL8 & Q8

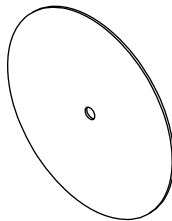

RPI Part #PCP201
New OEM Part #1539720
Old OEM Part #019832

INSULATION PAD
 • Ceramic fiber paper (white)
Fits: Between gasket retainer and door body
Model: AF10, XL10 & Q10

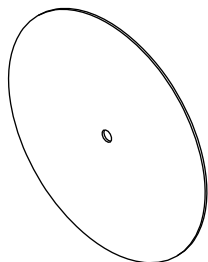

RPI Part #PCP228
OEM Part #3325086

PUMP (115VAC)
 • 28mA @ 115VAC: 50/60 Hz.
 • Rated air flow: 0.177 cfm
 • Rated pressure: 2.84 psig
 • Wire leads: 25" long with connector
Fits: Chassis
Model: AE8, XL8, Q8, AF10, XL10 & Q10

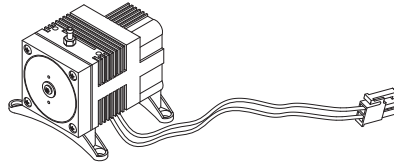

PM TIP
 For best results, replace the Pump Filter (RPI Part #SCF002) every year.

RPI Part #SCF002
OEM Part # (No OEM Part # Available)

COMPRESSOR FILTER
 • 1.080" ID x 2.080" OD x .310" thk
 • Polyethylene/Polyurethane Foam
 • 40 micron rating
 • Use with Pump (115VAC)
 (RPI Part #PCP228/ OEM Part #3325086)
Fits: Pump
Model: AE8, XL8, Q8, AF10, XL10 & Q10

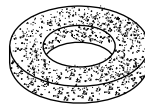

RPI Part #PCF180
OEM Part # 1881122

FRONT LEVELING FOOT
 • 2 per package
 • 1/4-20 x 1" lg. stem
Model: AE8, XL8, Q8, AF10, XL10 & Q10

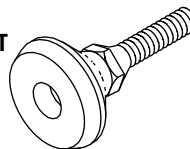

RPI Part #PCF179
OEM Part #1539308

RUBBER FOOT ASSEMBLY
 • Includes (2) sets of parts as shown
Fits: Bottom and rear assembly
Model: AE8, XL8, Q8, AF10, XL10 & Q10

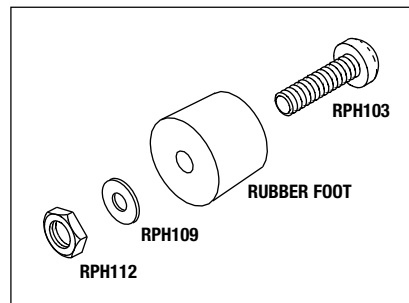

RPI Part #AMV097
New OEM Part #4205055
Old OEM Part #1881007

SAFETY VALVE (38 PSI)
 • Cracking pressure: 38 PSI
 • Brass; 1/2 MPT x 1/2 FPT
Fits: Chamber
Model: AE8, XL8, Q8, AF10, XL10 & Q10



RPI Part #PCH096
OEM Part #019769

HEATER & PLUG ASSEMBLY
 • Sheathing is silicone
 • 1360W, 120VAC, ~10Ω
Fits: Heater plate
Model: AF10 (Serial #'s 006000 and above), XL10 & Q10

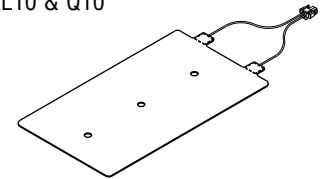

RPI Part #PCS230
new OEM Part #054544
old OEM Part #3325094

SURFACE SENSOR ASSEMBLY
 • Wire length: 17" lg
 • Sensor opens @ 311° F ± 8° F
 • Sensor closes @ 280° F ± 8° F
Fits: Sensor Bracket
Model: AE8, XL8, Q8, AF10, XL10 & Q10

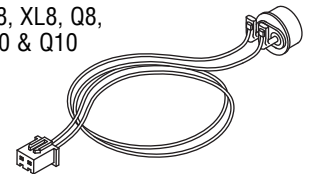

RPI Part #PCT192
OEM Part #1521512

OVERHEAT THERMOSTAT
 • Opens @ 356° F ± 8° F Temp Rise
 Closes @ 326° F ± 10° F
 • Automatic Reset
Fits: Cable Assembly/Chamber
Model: AE8, XL8, Q8, AF10, XL10 & Q10

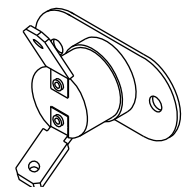

Table Top Sterilizers

Models: Delta AE8, XL8, Q8, AF10, XL10 & Q10 (continued)

RPI Part #PCK171
OEM Part #1539449

COUPLING-VENT/CONDENSER KIT

- Includes all parts as shown
- Fits:** Reservoir
- Model:** AE8, XL8, Q8, AF10, XL10 & Q10

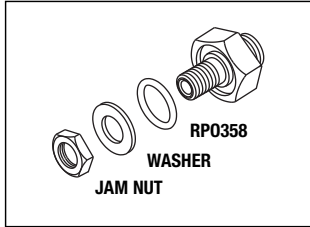

RPI Part #RPO358
New OEM Part #1881072
Old OEM Part #004840
Industry Part #2-113

O-RING

- 6 per package
- .549" ID x .755" OD x .103" C/S
- Material: EPDM
- Duro: 80
- Fits:** Coupling-Vent/Condenser
- Model:** AE8, XL8, Q8, AF10, XL10 & Q10

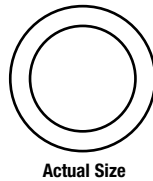

Visit the RPI website
www.rpiparts.com
 for a quick and easy
 resource for technical
 assistance including:

- PM Guides
- Exploded Views
- Service Tips
- Troubleshooting Guides
- Installation Instructions
- and more

RPI Part #PCL229
OEM Part #3325052



WATER LEVEL ASSEMBLY

- Wire length: 34" lg
- 1/2-13 Bulkhead Fitting
- Fits:** Water Reservoir
- Model:** AE8, XL8, Q8, AF10, XL10 & Q10

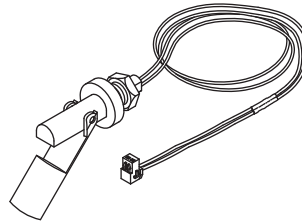

RPI Part #PCW177
OEM Part #1539563

MANIFOLD WASHER (SILICONE)

- Fits:** Float to Reservoir
- Model:** AE8, XL8, Q8, AF10, XL10 & Q10



RPI Part #RPO343
OEM Part #9435546
Industry Part #AS568-011

O-RING

- 12 per package
- .301" ID x .441" OD x .070" C/S
- Material: Red Silicone - 70 Duro
- Seals Reservoir Filter to Coupling
- Model:** AE8, XL8, Q8, AF10, XL10 & Q10



RPI Part #PCC176
OEM Part #1881106

CONDENSATION COIL

- 1/4" dia. Brass
- Includes compression nut and sleeve assembly
- Fits:** Reservoir Assembly
- Model:** AE8, XL8, Q8, AF10, XL10 & Q10

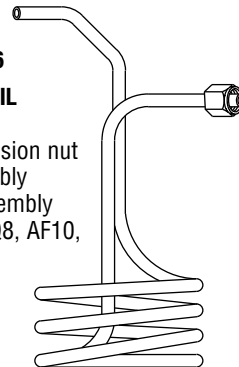

RPI Part #PCR227
OEM Part #3339913



RESERVOIR (UPGRADE)

- Material: Plastic
- Includes 1/2" Dia. hole for mounting the Water Level Assembly (RPI Part #PCL229)
- Includes Elbow Fitting 3/8" Barb (RPI Part #RPF687) for quick drain
- Fits:** Mounts to right side of Chamber
- Model:** Delta models AE8, XL8, Q8, AF10, XL10 & Q10

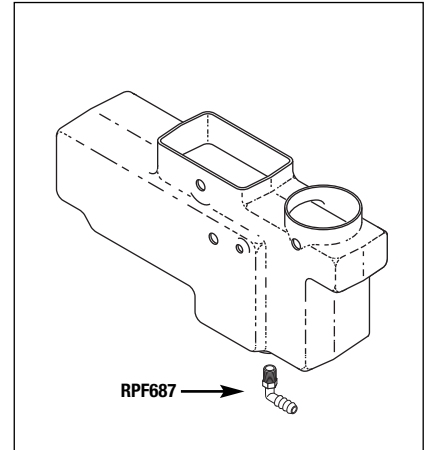

RPI Part #RPF687
OEM Part #1539381



ELBOW FITTING (3/8" BARB)

- 3/8" Barb x 1/4 MPT
- Material: Nylon®
- Included with Reservoir (Upgrade) (RPI Part #PCR227)
- Fits:** Reservoirs with a 3/8" Drain Line
- Model:** Delta models AE8, XL8, Q8, AF10, XL10 & Q10

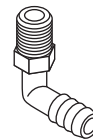

RPI Part #RPT113
OEM Part # (No OEM Part # Available)

MAX REGISTER THERMOMETER

- Mercury
- Length: 5-1/2"
- Accuracy Rating: ±1 Division (±2°F)
- Range: 150°F to 350°F
- Includes thermometer, and metal protective case
- Use for temperature verification in sterilizer

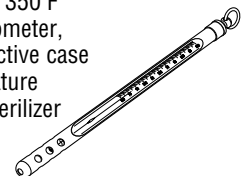

RPI Part #RPC288
OEM Part #1530661



POWER CORD

- 7 ft. lg.
 - 14/3 conductor SJT
 - Includes all parts as shown
 - NEMA; 5-15; 15A@125VAC; 105° C
 - For use and mounts with Strain Relief Bushing (RPI Part #RPB365)
- Model:** AE8, XL8, Q8, AF10, XL10 & Q10

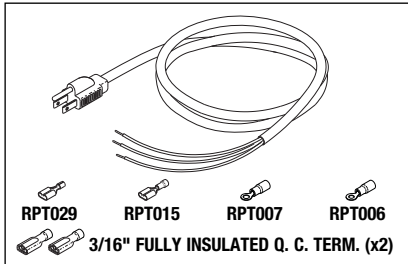

RPI Part #RPB365
OEM Part #7740640



STRAIN RELIEF

- Nylon®; 1.06" height from the panel; body length including flex tail: 3.86"
- Mounting hole: 3/4" dia.
- Note: this part has the same fit and function as the OEM, but does not look the same

Fits: Power cord to chassis
Model: AE8, XL8, Q8, AF10, XL10 & Q10

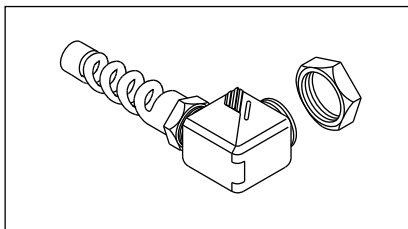

RPI Part #RPT462
OEM Part #9448598



TUBING (SILBRADE®)

- Sold by the foot (Does not include reel)
 - 1/8" ID x 3/8" OD
 - Translucent silicone tubing with reinforced braid
 - Maximum temperature: 350° F
 - Working Pressure: 233 psi @ 70° F
 - Use with HEPA Filter (RPI Part #RPF644)
- Fits:** Barbed Fittings (1/8" diameter)
Model: AE8, XL8, Q8, AF10, XL10 & Q10

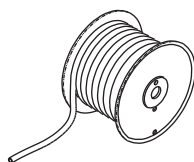

RPI Part #RPH285
OEM Part #1522510



DRAIN HOSE

- Sold by the foot (Does not include reel)
 - 3/8" ID x 5/8" OD
 - Clear PVC
- Model:** AE8, XL8, Q8, AF10, XL10 & Q10

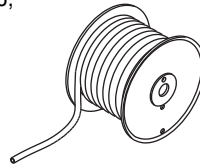

RPI Part #RPC463
OEM Part #044176



KWIK™ CLAMPS

- 6 per package
- Material: Nylon®; Color: White
- Clamping range: 5/16" - 25/64" dia. (.319" - .382")
- Temperature range: -40° F to 302° F

Fits: 3/8" OD tubing
Model: AE8, XL8, Q8, AF10, XL10 & Q10



RPI Part #ADC058
OEM Part # (No OEM Part # Available)



CORD CLIP

- 10 per package
 - 3/8" wire or bundle capacity
 - Natural Nylon® with adhesive backing
 - Meets UL94V-2 Flame Class
- Model:** AE8, XL8, Q8, AF10, XL10 & Q10



RPI Part #RPM542
OEM Part # (No OEM Part # Available)



CABLE TIE MOUNT (4-WAY)

- 10 per package
 - 1" x 1"
 - Natural Nylon®
 - Adhesive backed mount
 - .190" dia. countersunk mounting hole
 - Allows up to .22" wide cable ties
- Model:** AE8, XL8, Q8, AF10, XL10 & Q10



RPI Part #RPK431
OEM Part #4193376

DRAIN TUBE ASSEMBLY KIT (LARGE)

- Includes all parts as shown
- Fits:** Front Panel/Female Quick Connect Fitting - Grey (RPI Part #RPF426)
Model: AE8, XL8, Q8, AF10, XL10 & Q10

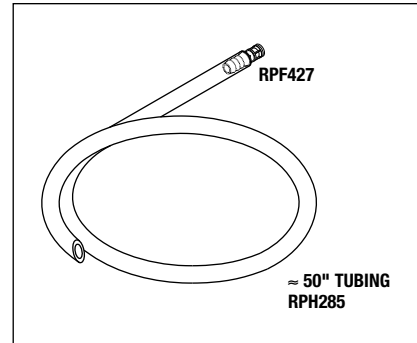

RPI Part #RPF426
OEM Part #1522494

FEMALE QUICK CONNECT FITTING (GREY)

- Includes all parts as shown
 - 3/8" (9.5 mm) hose barb: 0.28" Flow
 - Body material: Polypropylene; Seals material: EPDM
 - Bulkhead panel mount hose barb body with quick connect shut-off
- Fits:** Front Panel/Drain Tube Assembly Kit - Large (RPI Part #RPK431)
Model: AE8, XL8, Q8, AF10, XL10 & Q10

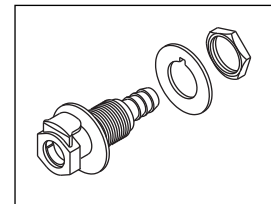

RPI Part #RPF427
OEM Part #1522502

MALE QUICK CONNECT FITTING (GREY)

- 3/8" (9.5 mm) hose barb: 0.28" Flow
 - Body material: Polypropylene; Seals material: EPDM
 - Hose barb insert; includes O-ring (RPI Part #RPO304)
- Fits:** Female Quick Connect (RPI Part #RPF426) on Front Panel/ Drain Tube Assembly Kit - Large (RPI Part #RPK431)
Model: AE8, XL8, Q8, AF10, XL10 & Q10

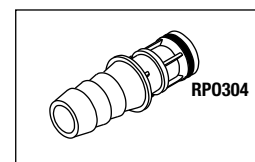
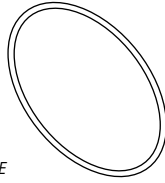
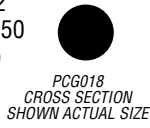

Table Top Sterilizers

Models: FL, FL2, GN, HP & HP2

RPI Part #PCG018
OEM Part #002122

DOOR GASKET
 • 6.50" OD x .30" dia. C/S
Fits: Chamber
Model: FL2
 (Serial #9250 and above)



RPI Part #PCG014
OEM Part #004014

DOOR GASKET
 • 8.25" OD
Fits: Door
Model: GN

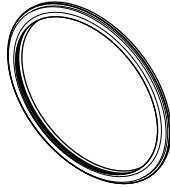

RPI Part #PCG016
OEM Part #003049

DOOR GASKET
 • 9.25" OD x .25" Sq. C/S
Fits: Door
Model: HP
 (Serial #7999 and below) only

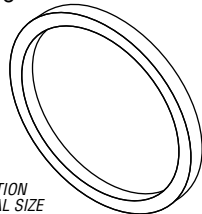
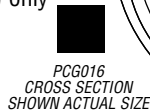

RPI Part #PCG017
OEM Part #002195

DOOR GASKET
 • 8.25" OD x .22" dia. C/S
Fits: Chamber
Model: HP2
 (Serial #8000 and above)

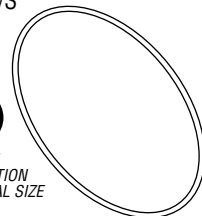

RPI Part #PCB123
New OEM Part #3000119
Old OEM Part #004080

BAND (10")
 • Stainless steel; 9/16" wide
 • Holds heaters in place
 • Clamping range:
 7 1/8" - 10"
Fits: 8" Chamber
Model: FL, HP,
 HP2, & GN

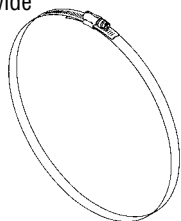

RPI Part #PCB001
OEM Part #004048

BELLOWS
Fits: Air Valve Housing
Models: FL, FL2, GN, HP & HP2

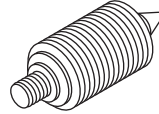

RPI Part #PCB002
OEM #002143

BELLOWS EXTENSION
Fits: Old style Bellows Cap
Models: GN & HP

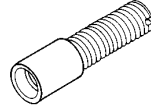

New RPI Part #RPO354
Industry Part #2-021

O-RING
 • 6 per package
 • Material: Red Silicone; 70 Duro
 • .926" ID x 1.066" OD x .070" C/S
Fits: Bellows Cap
Model: GN, HP & HP2

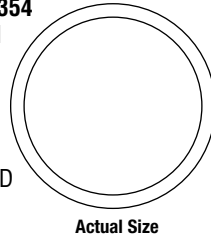

RPI Part #PCC005
OEM Part #004228

BELLOWS CAP
 • Brass; Requires Air Valve O-Ring (RPI Part #RPO354)
Fits: Air Valve Housing
Model: GN, HP & HP2

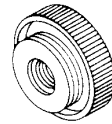

RPI Part #PCF011
OEM Part #002186

RUBBER FOOT
 • 4 per package
Models: FL2 & HP2

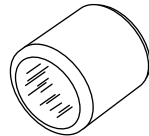

RPI Part #PCS047
OEM Part #002118

OVER TEMPERATURE SWITCH
 • Closes @ 240°F;
 • Opens @ 290°F
Models: FL, FL2 & GN

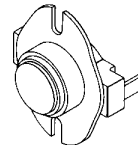

RPI Part #PCG039
OEM Part #002197

PRESSURE GAUGE
 • Reads 0-30 PSI
 • Bottom mount
 1/8" MPT
 • 2" dia. dial
Fits: Control Panel
Model: FL2 & HP2

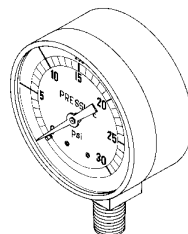

RPI Part #PCH022
OEM Part # (No OEM Part # Available)

HEATING ELEMENT
 • 1000W, 120VAC, ~14.5Ω
 • Sheathing: ElectroGalvanized Sheet Steel; Heater replaces two 500W heaters
Models: FL & FL2

Includes (2) #8-32 hex nut and (4) #8 flat washer

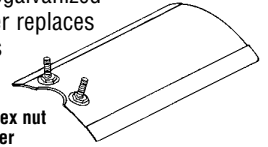

RPI Part #PCH021
OEM Part # (No OEM Part # Available)

HEATING ELEMENT
 • 1600W, 120VAC, ~9Ω
 • Sheathing: ElectroGalvanized Sheet Steel; Heater replaces two 800W heaters
Model: GN, HP & HP2

Includes (2) #8-32 hex nut and (4) #8 flat washer

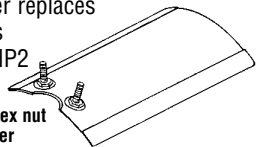

RPI Part #PCC003
OEM Part #004431

POWER CORD WITH CONNECTORS
 • 16/3 HSJO; 105° C
 • 13A @ 125VAC
 • 8 ft. lg.
 • Includes 2 ea 1/4" Q.C. Terminals and 1 ea #8 Ring Terminal installed
Models: FL & FL2



RPI Part #PCC004
OEM Part #004288

POWER CORD WITHOUT CONNECTORS
 • 16/3 HSJO; 105° C
 • 13A @ 125VAC
 • 8 ft. lg.
Model: GN, HP & HP2

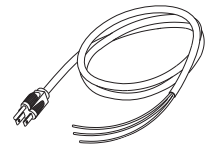

RPI Part #PCN136
OEM Part #004076

SPEEDNUT
 • 10 per package
 • "U" type #10-24 thread
Model: GN



RPI Part #RPT113
OEM Part # (No OEM Part # Available)

MAX REGISTER THERMOMETER
 • Mercury
 • Length: 5-1/2"
 • Accuracy Rating: ±1 Division (±2°F)
 • Range: 150°F to 350°F
 • Includes thermometer, and metal protective case
 • Use for temperature verification in sterilizer

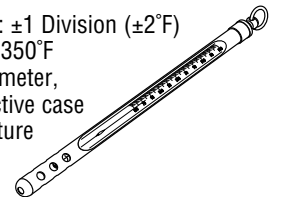

RPI Part #PCG019
OEM Part #004497

DOOR GASKET

- 16.500" OD
- Fits: Door

Model: Magnaclave

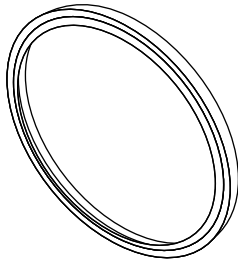

PCG019
CROSS SECTION
SHOWN ACTUAL SIZE

RPI Part #PCV109
OEM Part #004529

PRESSURE RELIEF VALVE

- 3/4" MPT x 3/4" FPT
- Cracking Pressure: 34 PSI

Fits: Chamber

Model: Magnaclave

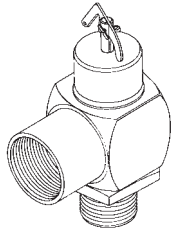

RPI Part #PCG040
OEM Part #3336356 & 015316

This Part Replaces
RPI Part #PCG038

PRESSURE GAUGE

- 1/4" MPT; 2" dia. Dial
- Center back mount: 1/8" MPT
- Includes mounting bracket, mounting hardware, and 3/16" tubing compression fitting
- Dual Scale: 0 to 60 psi / 0 to 400 kp

Fits: Control Panel

Model: Magnaclave

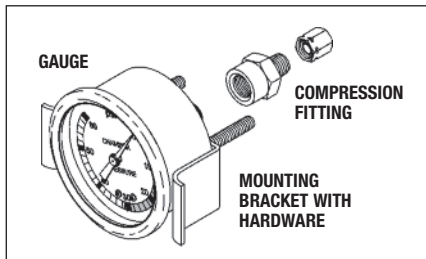

RPI Part #PCG079
OEM Part #4207796 & 015363

TEMPERATURE GAUGE

- Dual scale: 140°F to 345°F; 60°C to 180°C
- Includes all parts as shown
- 2" dia. dial
- Capillary tubing length: 54"

Fits: Control Panel

Model: Magnaclave

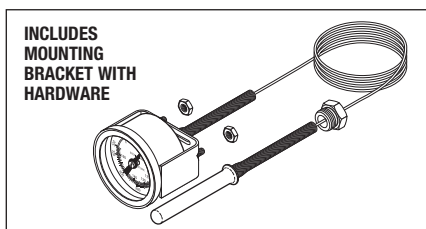

INCLUDES
MOUNTING
BRACKET WITH
HARDWARE

RPI Part #PCK216
OEM Part #004497

STERILIZER PM KIT

- Includes all parts as shown plus a PM Check List & PM Sticker

Model: Magnaclave

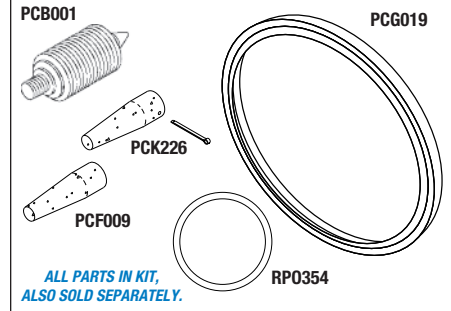

ALL PARTS IN KIT,
ALSO SOLD SEPARATELY.

RPI Part #PCK224
OEM Part #011047

BELLOWS KIT

- Includes all parts as shown

Model: Magnaclave

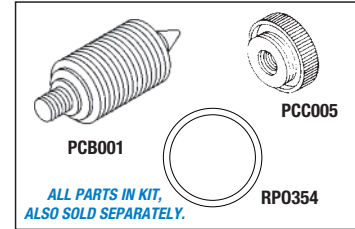

ALL PARTS IN KIT,
ALSO SOLD SEPARATELY.

RPI Part #PCB001
OEM Part #004048

BELLOWS

- Fits: Air Valve Housing

Model: Magnaclave

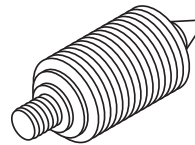

RPI Part #PCC005
OEM Part #004228

BELLOWS CAP

- Brass
- Requires Air Valve O-Ring (RPI Part #RPO354)

Fits: Air Valve Housing

Model: Magnaclave

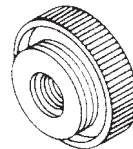

New RPI Part #RPO354
OEM Part #004004
Industry Part #2-021

AIR VALVE O-RING

- 6 per package
- Material: Red Silicone
- Hardness: 70 Duro
- .926" ID x 1.066" OD x .070" C/S

Fits: Air Valve Housing Bellows Cap

Model: Magnaclave

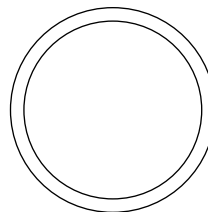

RPI Part #PCF009
OEM Part #1881031 & 004326

FILTER (FILL LINE)

- 120-150 micron filter

Fits: Fill Tube

Model: Magnaclave

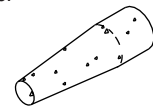

RPI Part #PCK226
OEM Part # (No OEM Part # Available)

FILTER WITH COTTER PIN

- Includes filter and cotter pin
- 120-150 micron filter

Fits: Condensation Coil

Model: Magnaclave

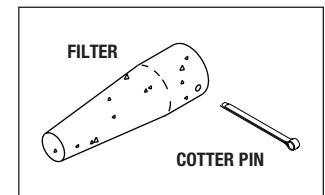

RPI Part #PCT013
OEM Part #004640

FILL VENT TUBE

- Material: 5/16" Brass tubing

Fits: Fill Filter and Chamber

Model: Magnaclave

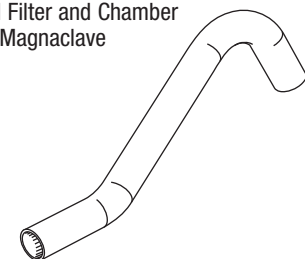

Table Top Sterilizers

Model: Magnaclave (continued)

RPI Part #PCT197
OEM Part #004505

OVERHEAT THERMOSTAT SWITCH

- Switch opens @ 470°F ±20°F
- Includes all parts as shown

Fits: Mounting hole on heating element
Model: Magnaclave

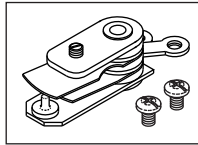

RPI Part #PCH091
OEM Part #004515

MAIN HEATER STRIP (208V)

- 1KW, 208VAC, ~43Ω
- Includes terminal hardware

Fits: Chamber
Model: Magnaclave

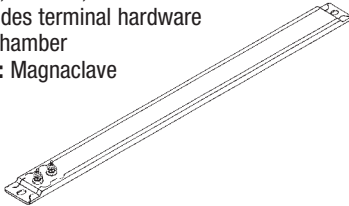

RPI Part #PCH092
OEM Part #004503

WALL HEATER STRIP (240V)

- 500W, 240VAC, ~115Ω
- Includes terminal hardware

Fits: Chamber
Model: Magnaclave

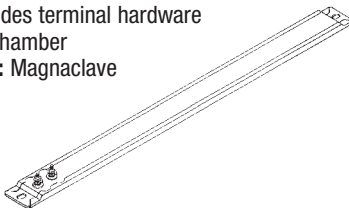

RPI Part #PCH083
OEM Part #004502

MAIN HEATER STRIP (240V)

- 1KW, 240VAC, ~58Ω
- Includes terminal hardware

Fits: Chamber
Model: Magnaclave

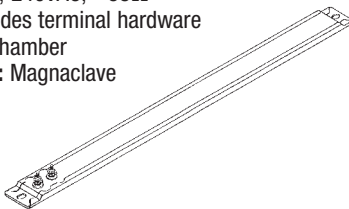

RPI Part #PCH089
OEM Part #004516

WALL HEATER STRIP (208V)

- 500W, 208VAC, ~87Ω
- Includes terminal hardware

Fits: Chamber
Model: Magnaclave

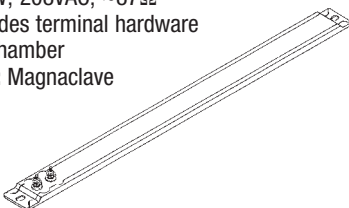

RPI Part #PCS043
OEM Part #004079

FUNCTION SWITCH (3 LEAD)

- 25A @ 125/250VAC; SPDT
- Mounts to bracket in main valve assembly
- 1/4" tabs

Model: Magnaclave

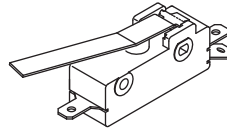

RPI Part #PCS044
OEM Part #004073

POWER SWITCH (2 LEAD)

- 20A @ 125/250VAC; SPST, N.O.
- Mounts to bracket in main valve assembly
- 1/4" tabs

Model: Magnaclave

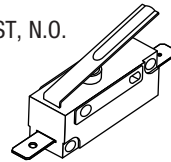

RPI Part #PCS094
OEM Part #004478

PRESSURE SWITCH

- 20A @ 125/250VAC; SPDT
- Mounts on frame of bellows assembly
- Includes: term screws and cup washers

Model: Magnaclave

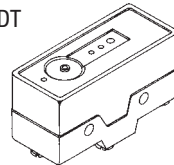

RPI Part #PCB237
OEM Part #004800 (Bellows only)

BELLOWS (PRESSURE SWITCH)

- Also available: Pressure Switch (RPI Part #PCS094)

Fits: Pressure Switch and Frame Assembly
Model: Magnaclave

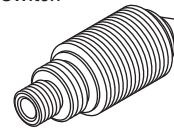

RPI Part #PCS087
OEM Part #004461

1 LB. PRESSURE SWITCH

- 20A @ 125/250VAC; SPST, N.C.
- Mounts to bracket on one pound pressure switch assembly
- 1/4" tabs

Model: Magnaclave

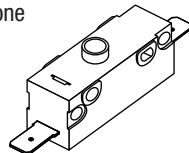

RPI Part #PCS086
OEM Part #004468

DOOR OPEN SWITCH

- 20A @ 125/250VAC; SPST, N.O.
- Mounts to bracket on partition in reservoir area
- 1/4" tabs

Model: Magnaclave

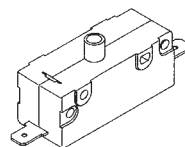

RPI Part #PCS090
OEM Part #004545

DOOR INTERLOCK SWITCH

- 20A @ 125/250VAC; SPDT, N.C.
- Mounts to bracket on door locking mechanism
- 1/4" tabs

Model: Magnaclave

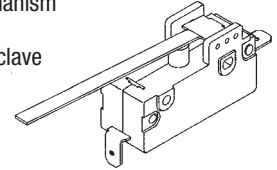

RPI Part #PCB088
OEM Part #004491

BUZZER

- 5mA @ 220VAC, 60 Hz
- 1/4" tabs

Fits: Mounts on machine Base
Model: Magnaclave

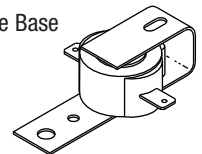

RPI Part #PCT082
OEM Part #004527

WALL THERMOSTAT

- Opens @ 245° F, Closes @ 215° F
- 1/4" tabs

Model: Magnaclave

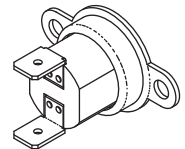

RPI Part #PCT081
OEM Part #004531 & 041001

ELECTRIC TIMER

- DPDT; 60 minute
- Switch: 7.5A @ 240VAC; 15A @ 125VAC
- Includes mounting hardware

Fits: Control Panel

Model: Magnaclave

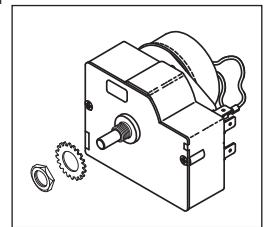

RPI Part #PCK245
OEM Part #004536 (Knob only) & 004507 (Faceplate only)

KNOB (TIMER)

- Knob: Black
- Time: 0-60 minutes
- Fits 1/4" dia. shaft
- Includes set screw
- Also available: Electric Timer (60 Minute) (RPI Part #PCT081)

Fits: Electric Timer (60 Minute)

Model: Magnaclave

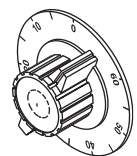

RPI Part #PCK243
OEM Part #004625 (Knob only), **004508** (Faceplate only), & **004626** (Stop Plate only)

KNOB (TEMPERATURE)

- Knob: Black
 - Faceplate: 240°F - 270°F
 - Fits 1/4" dia. shaft
 - Includes set screw
- Fits:** Thermostat Control
Model: Magnaclave



RPI Part #PCK244
OEM Part #004536 (Knob only) & **004506** (Faceplate only)

KNOB (FUNCTION)

- Knob: Black
 - Faceplate: Power Off, Fill, Sterilize and Vent
 - Fits 1/4" dia. shaft
 - Includes set screw
- Fits:** Main Valve Control Shaft
Model: Magnaclave

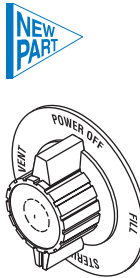

RPI Part #PCL029
OEM Part #004501

LAMP (OPEN DOOR)

- 250VAC, 1/3W
 - 1/4" tabs
- Fits:** Control Panel
Model: Magnaclave

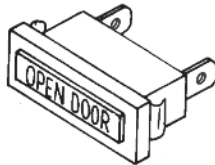

RPI Part #PCL030
OEM Part #004499

LAMP (HEAT ON)

- 250VAC, 1/3W
 - 1/4" tabs
- Fits:** Control Panel
Model: Magnaclave

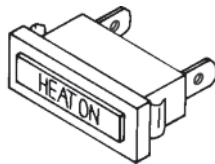

RPI Part #PCL031
OEM Part #004500

LAMP (STERILE)

- Fits: Control Panel
 - 250VAC, 1/3W
 - 1/4" tabs
- Model:** Magnaclave

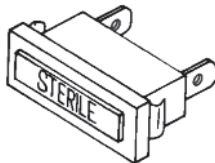

RPI Part #PCL032
OEM Part #004498

LAMP (POWER ON)

- Fits: Control Panel
 - 250VAC, 1/3W
 - 1/4" tabs
- Model:** Magnaclave

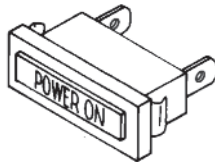

RPI Part #PCN136
OEM Part #004076

SPEEDNUT

- 10 per package
 - "U" type #10-24 thread
- Model:** Magnaclave



RPI Part #PCR251
OEM Part #045805

RELAY (K1 & K3)

- Size: 2.69" L x 1.32" W x 1.85" H
 - Coil: 200/240VAC
 - Contacts: DPST; 25A N.O.
 - 1/4" Tabs
- Fits:** Chassis
Model: Magnaclave
 (Serial #7525 and above)

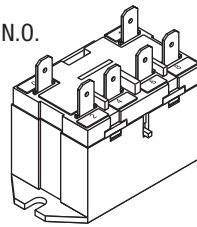

RPI Part #PCR252
OEM Part #045806

RELAY (K2)

- Size: 2.70" L x 1.36" W x 1.49" H
 - Coil: 220/240VAC
 - Contacts: DPDT; 30A N.O./3A N.C.
 - 1/4" Tabs
- Fits:** Chassis
Model: Magnaclave
 (Serial #7525 and above)

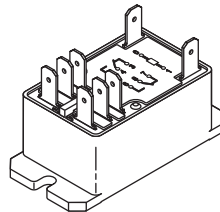

RPI Part #PCR234
OEM Part #041002 & A62-011081

RELAY (ELECT. CONTACTOR)

- Coil: 208/240VAC
 - 2 pole, contacts rated 20A
 - 1/4" tabs
- Fits:** Rear Chassis Support
Model: Magnaclave

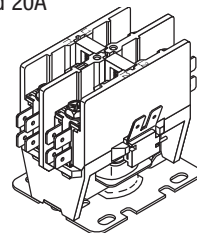

RPI Part #PCS235
OEM Part #004837 & B02-004837

RELAY SOCKET

- 8 Pin
 - Also available: Latching Relay (RPI Part #PCR196)
- Fits:** Reservoir Support
Model: Magnaclave

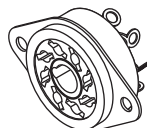

RPI Part #PCR196
OEM Part #004463

LATCHING RELAY

- 250VAC coil
 - 8 pin octal configuration
 - Also available: Relay Socket (RPI Part #PCS235)
- Fits:** Relay Socket
Model: Magnaclave

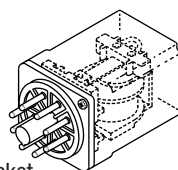

RPI Part #PCK236
OEM Part #5473041

SOLENOID KIT (DOOR LATCH)

- 240VAC, 200Ω solenoid, pull type
 - Includes all parts as shown
- Fits:** Door Locking Bracket
Model: Magnaclave

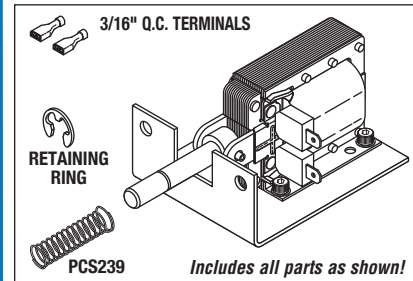

RPI Part #PCS239
OEM Part #004525 & A63-004525

SPRING (DOOR INTERLOCK)

- ~.312" OD x 1.100" lg x .027" wire dia.
 - Material: Stainless Steel
 - Also included in Solenoid Kit (Door Latch) (RPI Part #PCK236)
- Fits:** Door Lock Pin
Model: Magnaclave

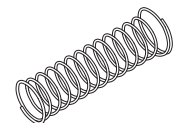

RPI Part #PCK242

OEM Part #004001 (E-Ring), **004395** (Bushing), **004502** (Brass Washer) & **006703** (Plastic Washer)

BUSHING KIT (DOOR HINGE)

- Includes all parts as shown
- Fits:** Door Support
Model: Magnaclave

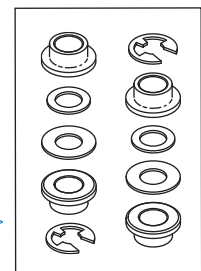

RPI Part #RPT113

OEM Part # (No OEM Part # Available)

MAX REGISTER THERMOMETER

- Mercury; Size: ~.40" OD x ~6.63" lg.
- Accuracy Rating: ±1 Division (±2°F)
- Dual scale: 150°F to 350°F / 65°C to 177°C
- Includes thermometer, and metal protective case
- Use for temperature verification in sterilizer

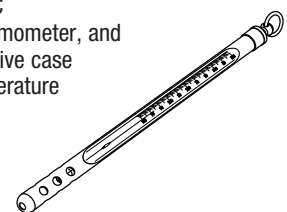

Table Top Sterilizers

Model: Magnaclave (continued)

RPI Part #PCK240
OEM Part #004598, 004864, 004599, 005929, & 091007



DRAIN KIT

- Includes all parts as shown
- Some parts also sold separately
- Fits:** Drain Adapter and Tube Assembly
- Model:** Magnaclave

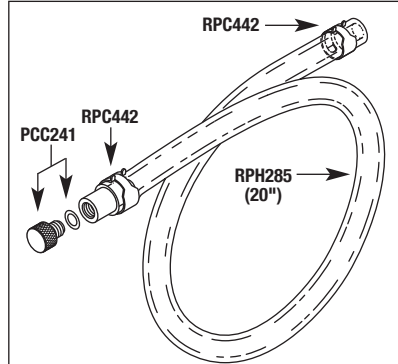

Kit Includes all parts as shown.

RPI Part #PCC241
OEM Part #004598 (Cap) & (O-Rings) 004864



DRAIN CAP WITH O-RING

- Material: Brass
- Includes all parts as shown
- Fits:** Drain Kit (RPI Part #PCK240)
- Model:** Magnaclave

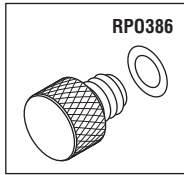

RPI Part #RPO386
OEM Part #004864

O-RING - 6/PKG

- Material: Silicone; 70 Duro
- Size: .239" ID x .379" OD x .070" C/S
- Fits:** Drain Cap
- Model:** Magnaclave

RPI Part #RPH285
OEM Part # (No OEM Part # Available)

DRAIN HOSE

- Material: Clear PVC
- Size: 3/8" ID x 5/8" OD x 1/8" Wall
- Sold by the foot; reel not included
- Fits:** Drain Kit (RPI Part #PCK240)
- Model:** Magnaclave

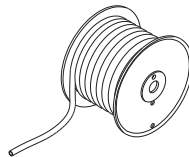

RPI Part #RPC442
OEM Part # (No OEM Part # Available)

UNI-CLAMP - 6/PKG

- Fits .65"/.83" OD tubing
- Fits:** Drain Kit (RPI Part #PCK240)
- Model:** Magnaclave



RPI Part #PCK238
OEM Part #004630 & A65-004630



CONDENSATION COIL KIT

- .312" OD brass tubing
- Includes all parts as shown
- Some parts also sold separately
- Fits:** Reservoir
- Model:** Magnaclave

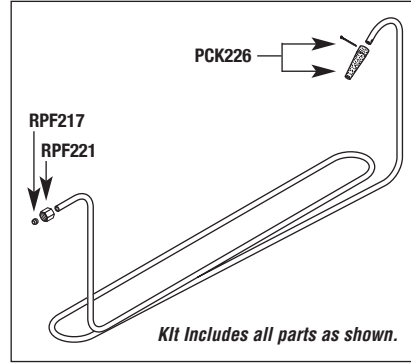

Kit Includes all parts as shown.

RPI Part #PCV075
OEM Part #004310

Valve supplied with "packings" pressed-in

MAIN VALVE BODY

- Material: Brass
- Valve supplied with Teflon "packings" pressed-in
- Also available: Male Elbow (RPI Part #RPF232)
- Fits:** Main Valve Assembly
- Model:** Magnaclave

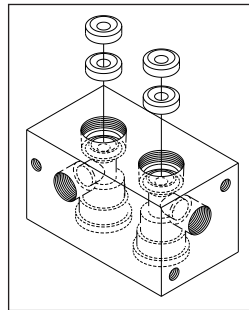

RPI Part #PCN072
OEM Part #004027

MAIN VALVE NUT

- Material: Brass
- Fits:** Main Valve
- Model:** Magnaclave

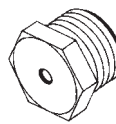

RPI Part #PCC073
OEM Part #004030

MAIN VALVE CAP

- Material: Brass
- Fits:** Main Valve
- Model:** Magnaclave

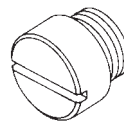

RPI Part #RPO355
OEM Part #004000
Industry Part #AS568-019

MAIN VALVE O-RING

- 6 per package
- Material: Silicone; 70 Duro
- Size: .801" ID x .941" OD x .070" C/S
- Fits:** Main Valve Cap
- Model:** Magnaclave

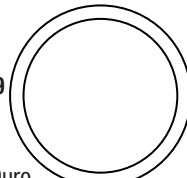

RPI Part #PCK226
OEM Part # (No OEM Part # Available)

FILTER WITH COTTER PIN

- Includes Filter and Cotter Pin
- Fits:** Condensation Coil
- Model:** Magnaclave

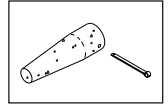

RPI Part #RPF221
OEM Part # (No OEM Part # Available)

COMPRESSION NUT - 5/PKG

- Material: Brass; 5/16" Tubing
- Fits:** Condensation Coil
- Model:** Magnaclave

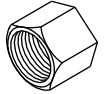

RPI Part #RPF217
OEM Part # (No OEM Part # Available)

COMPRESSION SLEEVE - 5/PKG

- Material: Brass; 5/16" Tubing
- Fits:** Condensation Coil
- Model:** Magnaclave



RPI Part #PCK026
OEM Part #017706
(OEM has only 1 set)

MAIN VALVE KIT

- **To repair valve, need (2) Main Valve Kits (RPI Parts #PCK026)**

Fits: Main Valve
Model: Magnaclave

To Repair Valve, You Will Need (2) Kits!

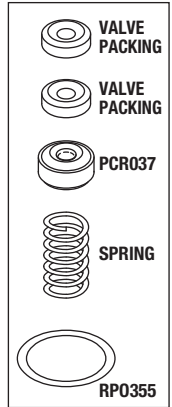

RPI Part #PCRO37
OEM Part #004039

VALVE BUTTON RETAINER

- Material: Brass holder with Teflon seat
- Fits:** Main Valve
- Model:** Magnaclave



RPI Part #PCS074
OEM Part #004028

MAIN VALVE STEM

- Material: Stainless steel
- Size: 1/8" dia. x ~1.60" lg.
- Fits:** Main Valve
- Model:** Magnaclave

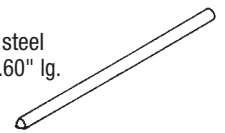

RPI Part #PCA118
OEM Part #004231

LOCATOR ARM

- 3 per package
- Material: Black oxide spring steel
- Mounts to Main Valve
- Model:** Magnaclave

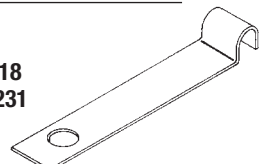

RPI Part #PCG014
OEM Part #004014

DOOR GASKET

- 8.250" OD
- Fits: Door
- Model: OCM

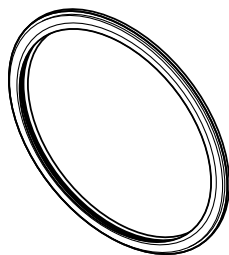

PCG014
CROSS SECTION
SHOWN ACTUAL SIZE

RPI Part #PCG015
OEM Part #004341

DOOR GASKET

- 10.250" OD
- Fits: Door
- Models: OCR & OCR+

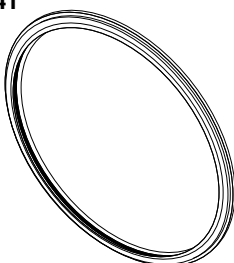

PCG015
CROSS SECTION
SHOWN ACTUAL SIZE

RPI Part #PCG020
OEM Part #001187

DOOR GASKET

- 7.000" OD
- Fits: Door
- Model: Sentry

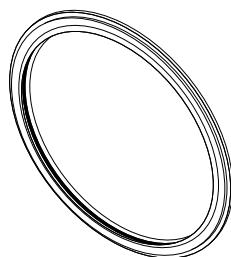

PCG020
CROSS SECTION
SHOWN ACTUAL SIZE

RPI Part #PCV052
OEM Part #004146

PRESSURE RELIEF VALVE

- 1/2" MPT x 1/2" FPT
- Cracking Pressure: 35 PSI
- Fits: Chamber
- Models: OCM, OCR, OCR+ & Sentry

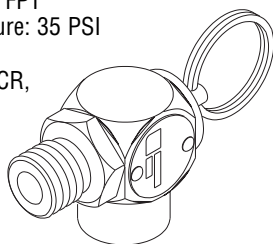

RPI Part #PCK218
OEM Part #004014/(Door Gasket only)

STERILIZER PM KIT

- Includes all parts as shown
- Model: OCM

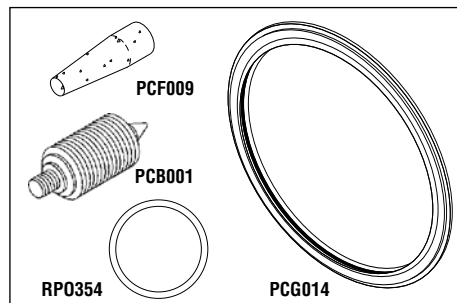

ALL PARTS IN KIT,
ALSO SOLD SEPARATELY.

RPI Part #PCK219
OEM Part #004341/(Door Gasket only)

STERILIZER PM KIT

- Includes all parts as shown
- Models: OCR & OCR+

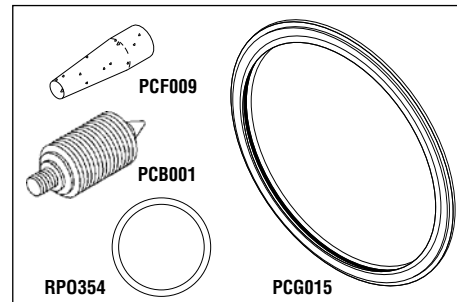

ALL PARTS IN KIT,
ALSO SOLD SEPARATELY.

RPI Part #PCK217
OEM Part #001187/(Door Gasket only)

STERILIZER PM KIT

- Includes all parts as shown
- Model: Sentry

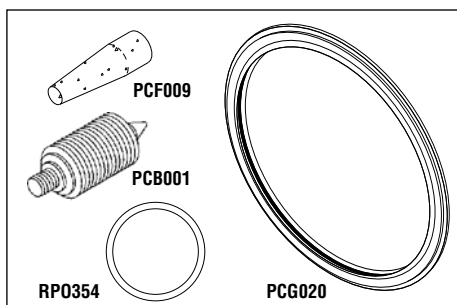

ALL PARTS IN KIT,
ALSO SOLD SEPARATELY.

RPI Part #PCK224
OEM Part #011047

BELLOWS KIT

- Includes all parts as shown
- Models: OCM, OCR, OCR+ & Sentry

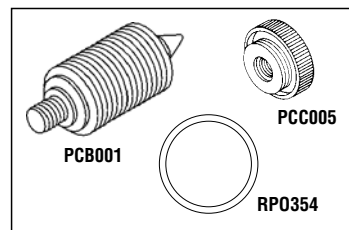

ALL PARTS IN KIT,
ALSO SOLD SEPARATELY.

RPI Part #PCK225
OEM Part #004439

FILTER & TUBE KIT

- Includes all parts as shown
- Models: OCM, OCR & OCR+

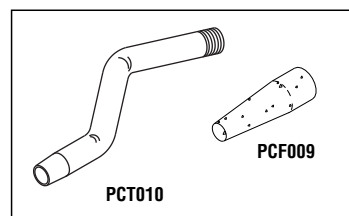

ALL PARTS IN KIT,
ALSO SOLD SEPARATELY.

For a FREE copy of the OCM/OCR/OCR+ RPI Troubleshooting Guide with Exploded View, contact RPI or visit the RPI website at: www.rpiparts.com and go to the "Tech Help" page to download the guide.

Table Top Sterilizers

Models: OCM® (A3), OCR® (A4), OCR+® (A8) & Sentry® (A7) (continued)

RPI Part #PCT061
OEM Part #024401

SOLID STATE CONTROLLER

- Trim Pot may need to be adjusted
 - Mounts on bottom plate of machine
- Model: Sentry

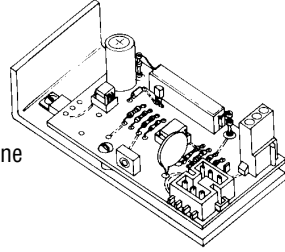

RPI Part #PCT007
OEM Part #019110

SOLID STATE CONTROLLER WITH HARNESS

- Includes all parts as shown
 - Trim Pot may need to be adjusted
 - Mounts on bottom plate of machine
- Models: OCM, OCR & OCR+

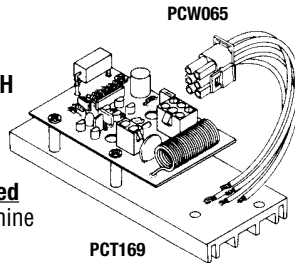

RPI Part #PCT169
OEM Part #019110/Board only

SOLID STATE CONTROLLER

- Does not include Controller Board Wire Harness (PCW068)
 - Trim Pot may need to be adjusted
 - Mounts on bottom plate of machine
- Models: OCM, OCR & OCR+

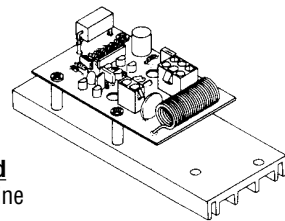

RPI Part #PCW068
OEM Part #019110/Harness only

CONTROLLER BOARD WIRE HARNESS

- Models: All OCM, OCR & OCR+ models using Solid State Controller

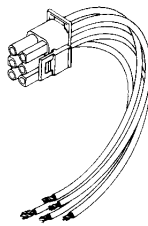

RPI Part #PCK128
OEM Part # (No OEM Part # Available)

THERMOSTAT CONVERSION KIT

- Use to convert machines with hydraulic thermostat controls to a solid state thermostat control
 - Trim Pot may need to be adjusted
- Models: OCM & OCR

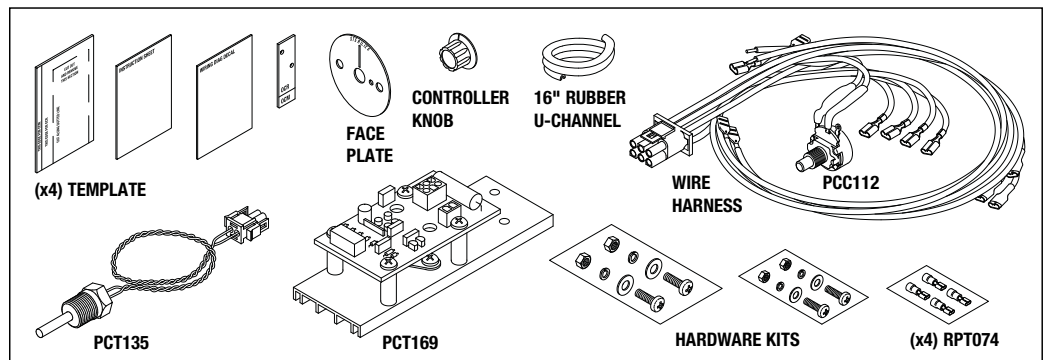

RPI Part #PCT042
OEM Part #004108

OVERHEAT THERMOSTAT

- Operates between 220°F - 350°F; Factory set at 295°F
 - Includes thermostat, and (2) terminal screw
- Models: OCM, OCR, OCR+ & Sentry

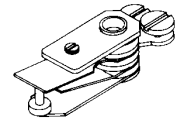

RPI Part #PCH023
OEM Part #014603

HEATING ELEMENT

- 1600 W, 120 VAC, ~9Ω
 - Sheathing: Electrogalvanized Sheet Steel
 - Includes heating element, hardware, and (3 ft.) #14 AWG White Wire-High Temp (RPI Part #RPW086)
 - Heater has flip-up tab to mount overtemp switch
- Fits: Chamber
Models: OCR & OCR+

Whenever changing heaters, change the Overheat Thermostat (RPI Part # PCT042) at the same time.

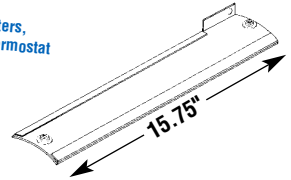

RPI Part #PCH024
OEM Part #014601

HEATING ELEMENT

- 1250 W, 120 VAC, ~12Ω
 - Sheathing: Electrogalvanized Sheet Steel
 - Includes heating element, hardware, and (3 ft.) #14 AWG White Wire-High Temp (RPI Part #RPW086)
 - Heater has flip-up tab to mount overtemp switch
- Fits: Chamber
Models: OCM & Sentry (For Sentry, heater does not fit side position)

Whenever changing heaters, change the Overheat Thermostat (RPI Part # PCT042) at the same time.

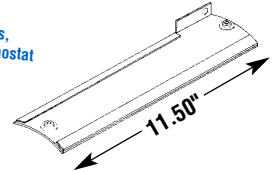

RPI Part #PCH048
OEM Part # (No OEM Part # Available)

HEATING ELEMENT

- 1250 W, 120 VAC, ~12Ω
 - Sheathing: Electrogalvanized Sheet Steel
 - Includes heating element, hardware, and (3 ft.) #14 AWG White Wire-High Temp (RPI Part #RPW086)
 - Heater has flip-up tab to mount overtemp switch
- Fits: Chamber
Model: Older OCM with front drain pipe under chamber (Serial #1001 to 5000)

Whenever changing heaters, change the Overheat Thermostat (RPI Part # PCT042) at the same time.

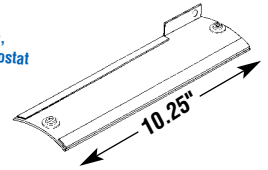

RPI Part #PCH147
OEM Part #001132

HEATER/SIDE ELEMENT

- 100 W, 120 VAC, ~144Ω
 - Sheathing: Electrogalvanized Sheet Steel
- Fits: Side of Chamber
Model: Sentry

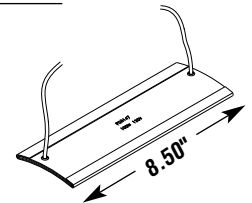

RPI Part #PCC062

OEM Part # (No OEM Part # Available)

THERMISTOR CONNECTOR

- Includes all parts as shown
- Fits:** Thermistor to Solid State Controller
- Models:** OCM, OCR & OCR+

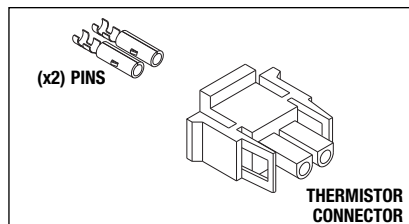

RPI Part #PCT008

OEM Part #019149

THERMISTOR ASSEMBLY

- Includes all parts as shown
- Rated: 1 M Ω @ 25° C
- 1/4" MPT
- Top of chamber near safety relief valve

Fits: Consistent with Solid State Controller (RPI Part #PCT135)
Models: OCM, OCR & OCR+

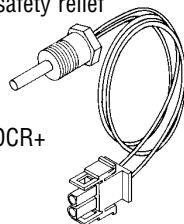

RPI Part #PCT135

OEM Part # (No OEM Part # Available)

THERMISTOR

- Includes all parts as shown
- Rated: 1 Meg Ω @ 25° C
- 3/8" MPT
- **Use only with Thermostat Conversion Kit (RPI Part #PCK128)**

Fits: 3/8" MPT thermowell in chamber bottom
Models: OCM & OCR

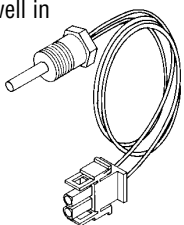

RPI Part #PCT063

OEM Part #001340

THERMISTOR ASSEMBLY

- Rated: 1 M Ω @ 25° C
- 1/4" MPT
- Includes all parts as shown
- Fits:** Solid State Controller (RPI Part #PCT061)
- Model:** Sentry

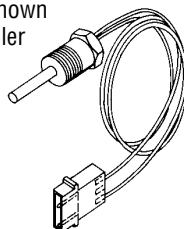

RPI Part #PCH186

OEM Part #019155

WIRING HARNESS

- Includes 20 K Ω Controller (RPI Part #PCC112) and all parts as shown
- All terminals crimped and soldered
- Models:** OCM (S/N #69564 and above)

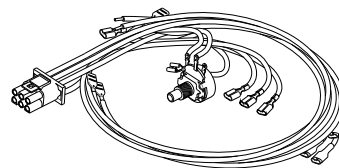

RPI Part #PCH187

OEM Part #019156

WIRING HARNESS

- Includes 20 K Ω Controller (RPI Part #PCC112) and all parts as shown
- All terminals crimped and soldered
- Models:** OCR (S/N #15050 and above)

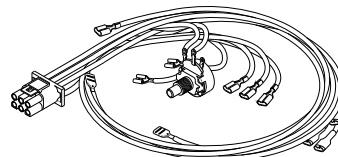

RPI Part #PCB134

OEM Part #017985

ELECTRICAL TERMINAL BUSHING

- 3 per package
- Accommodates 1/4" tabs; 11/16" dia.

Fits: Firewall
Models: OCM & OCR

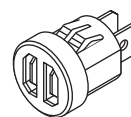

RPI Part #PCC112

OEM Part #004144

CONTROLLER

- Includes mounting hardware
- Used with Solid State Controller
- 20 K Ω
- .250" dia. shaft
- Also available, Thermostat Conversion Kit (RPI Part #PCK128)

Fits: Control panel
Models: OCM, OCR, OCR+ & Sentry

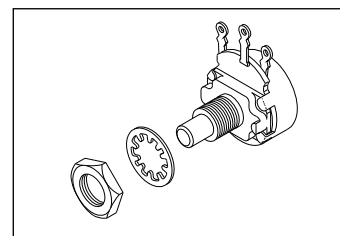

RPI Part #PCS148

OEM Part #001203

DOOR SWITCH

- SPDT
- 11 A @ 125 VAC
- 2" lg. lever arm
- Mounts to support bracket
- Models:** Sentry

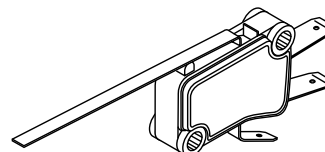

RPI Part #PCS044

OEM Part #004073

POWER SWITCH

- (2 LEAD)
- Mounts to bracket in main valve assembly
- Models:** OCM, OCR, OCR+ & Sentry

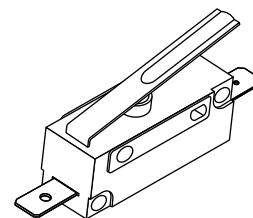

RPI Part #PCS043

OEM Part #004079

FUNCTION SWITCH (3 LEAD)

- 20A @ 125-250 VAC, 1HP @ 125 VAC, 2HP @ 250 VAC
- Mounts to bracket in main valve assembly
- Models:** OCM, OCR, OCR+ & Sentry

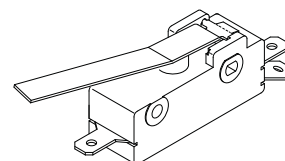

Table Top Sterilizers

Models: OCM® (A3), OCR® (A4), OCR+® (A8) & Sentry® (A7) (continued)

RPI Part #PCG040
 New OEM Part #3336356
 Old OEM Part #015316

PRESSURE GAUGE

- 1/4" MPT; 2" dia. gauge
 - Center back mount 1/8-28 BSPP
 - Includes all parts as shown
 - Dual Scale: 0 to 60 psi / 0 to 400 kp
- Fits:** Control Panel
Models: OCM, OCR & OCR+

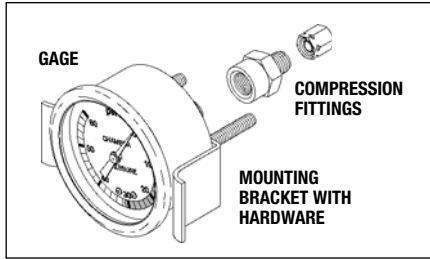

RPI Part #PCG050
 NEW OEM Part #4700147
 OLD OEM Part #014451

TEMPERATURE GAUGE

- Dual scale: 50°F to 350°F; 40°C to 176°C
 - Includes all parts as shown
 - 2" dia. dial; Capillary tubing length: 21"
- Fits:** Control Panel
Models: OCM, OCR & OCR+

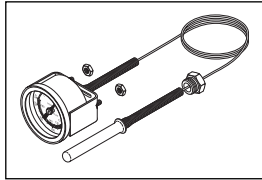

RPI Part #PCT049
 OEM Part #004112

BELL TIMER

- 60 minute
 - Includes washer and hex nut
- Fits:** Control Panel
Models: OCM, OCR, OCR+ & Sentry

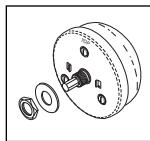

RPI Part #PCG051
 OEM Part #001210

TEMPERATURE GAUGE

- Reads 220°F - 300°F
 - Panel cutout: 5/8" x 1-3/4"
 - Includes all parts as shown
- Fits:** Control Panel
Model: Sentry

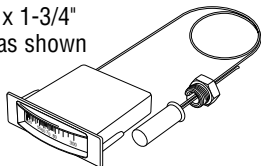

RPI Part #PCG041
 OEM Part #001212

PRESSURE GAUGE

- Reads 0-60 PSIG
 - Panel cutout: 5/8" x 1-3/4"
 - Includes all parts as shown
- Fits:** Control Panel
Model: Sentry

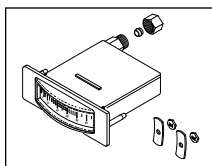

RPI Part #PCV075
 OEM Part #004310

MAIN VALVE BODY

- Valve supplied with "packings" pressed in
- Fits:** Main Valve Assembly
Models: OCM, OCR, OCR+ & Sentry

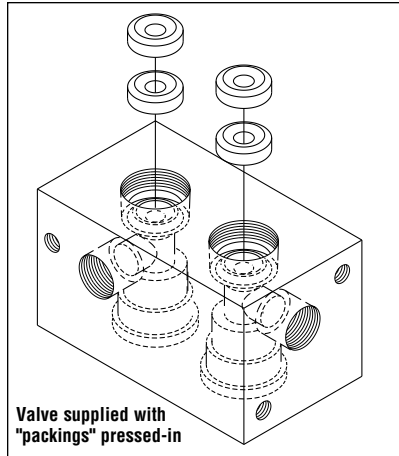

Valve supplied with "packings" pressed-in

RPI Part #PCC073
 OEM Part #004030

MAIN VALVE CAP

- Fits:** Main Valve
Models: OCM, OCR, OCR+ & Sentry

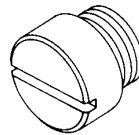

RPI Part #PCN072
 OEM Part #004027

MAIN VALVE NUT

- Brass
- Fits:** Main Valve
Models: OCM, OCR, OCR+ & Sentry

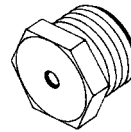

New RPI Part #RPO355
 OEM Part #004000
 Industry Part #2-019

MAIN VALVE O-RING

- 6 per package
 - Material: Red Silicone
 - Hardness: 70 Duro
 - .801" ID, .941" OD, .070" C/S
- Fits:** Main Valve
Models: OCM, OCR, OCR+ & Sentry

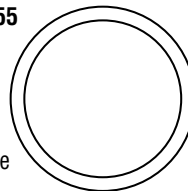

RPI Part #PCK026
 OEM Part #017706 (OEM has only 1 set)

MAIN VALVE KIT

- To repair valve, need (2) Main Valve Kits (RPI Parts #PCK026)
- Fits:** Main Valve
Models: OCM, OCR, OCR+ & Sentry

TO REPAIR VALVE, YOU WILL NEED (2) KITS!

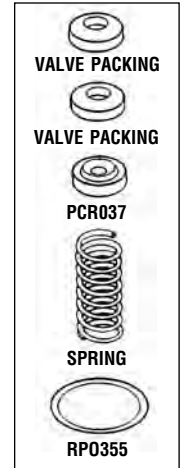

RPI Part #PCR037
 OEM Part #004039

VALVE BUTTON RETAINER

- Fits:** Main Valve
Models: OCM, OCR, OCR+ & Sentry

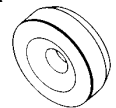

RPI Part #PCS074
 OEM Part #004028

MAIN VALVE STEM

- Fits:** Main Valve
Models: OCM, OCR, OCR+ & Sentry

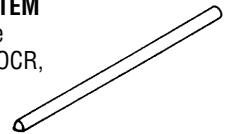

RPI Part #PCA118
 OEM Part #004231

LOCATOR ARM

- 3 per package
 - Mounts to Main Valve
- Models:** OCM, OCR & OCR+

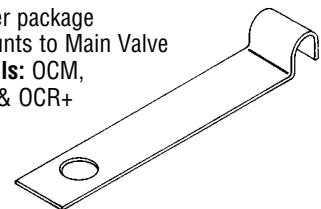

RPI Part #PCC138
OEM Part #0222452

CASING SCREWS & SPEEDNUT
ALSO SOLD SEPARATELY
ASK FOR RPI PART #PCS133 & PCN136
(See page 1018)

OUTER CASING

- Stainless steel
- Mounts to bottom platform
- For screws and nuts to attach casing to base machine, use RPI Part #'s PCS133 & PCN136

Model: OCM

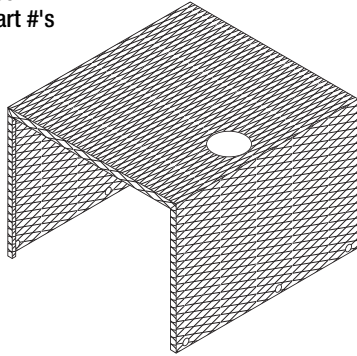

RPI Part #PCB126
OEM Part #004096

BOLT

- 12 per package • 1/4-20 x 3/4" lg. • Hardened Steel: Grade 8
- Fits: OEM Hinge & Catch only

Model: OCM



RPI Part #PCK206
OEM Part # (No OEM Part # Available)

FLANGE REINFORCING BLOCKS

- Includes (2) sets of parts shown: flange reinforcing block, and 1/4-20 x 1-1/4" lg. Grade 8 mounting bolt
- All parts zinc plated

Fits: Only fits RPI Chamber Assembly (RPI Part #PCC114)

Model: OCM

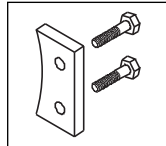

RPI Part #PCS150
OEM Part #4205592

FRAME SUPPORT KIT

- Includes (2) sets of parts shown: support, cage nut, and 1/4-20 x 1" lg. Grade 8 mounting bolt
- Stainless steel frame supports

Fits: Mounting Flange Brackets on OEM Chamber only

Model: OCM

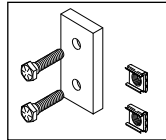

RPI Part #RPI268
OEM Part # (No OEM Part # Available)

CHAMBER INSULATION

- 14-1/4" x 28" x 1/4" thk
- White ceramic fiber paper
- Cut to fit 8" dia. chambers

Fits: Wraps around chamber of autoclave

Model: OCM (8" Chamber)

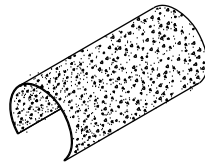

RPI Part #PCB123
New OEM Part #3000119
Old OEM Part #004080

BAND (10")

- Stainless steel; 1/2" wide
- Holds heaters in place

Models: OCM & Sentry



RPI Part #PCC139
OEM Part #017919

CASING SCREWS & SPEEDNUT
ALSO SOLD SEPARATELY
ASK FOR RPI PART #PCS133 & PCN136
(See page 1018)

OUTER CASING

- Stainless steel
- Mounts to bottom platform
- For screws and nuts to attach casing to base machine, use RPI Part #'s PCS133 & PCN136

Model: OCR

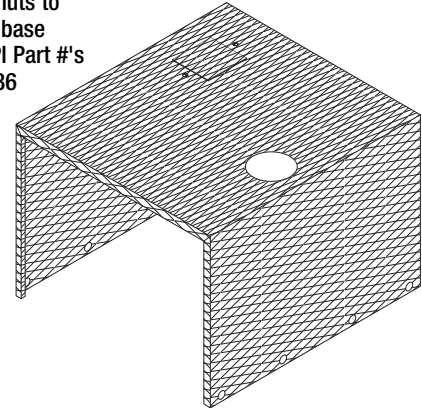

RPI Part #PCB127
OEM Part #022727

BOLT

- 12 per package • 5/16-18 x 1" lg. • Hardened Steel: Grade 8
- Fits: OEM Hinge & Catch only

Model: OCR

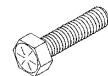

RPI Part #PCK205
OEM Part # (No OEM Part # Available)

FLANGE REINFORCING BLOCKS

- Includes (2) sets of parts shown: flange reinforcing block, and 5/16-18 x 1-1/2" lg. Grade 8 mounting bolt
- All parts zinc plated

Fits: Only fits RPI Chamber Assembly (RPI Part #PCC116)

Model: OCR

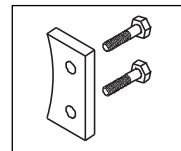

RPI Part #PCS151
OEM Part #4205550

FRAME SUPPORT KIT

- Includes (2) sets of parts shown: support, cage nut, and 5/16-18 x 1-1/4" lg. Grade 8 mounting bolt
- Stainless steel frame supports

Fits: Mounting Flange Brackets on OEM Chamber only

Model: OCR

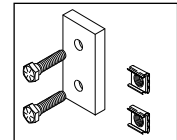

RPI Part #RPI269
OEM Part # (No OEM Part # Available)

CHAMBER INSULATION

- 18-1/4" x 33-3/4" x 1/4" thk
- White ceramic fiber paper
- Cut to fit 10" dia. chambers

Fits: Wraps around chamber of autoclave

Model: OCR & OCR+ (10" Chamber)

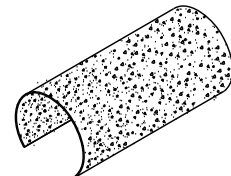

RPI Part #PCB122
New OEM Part #1539647
Old OEM Part #004325

BAND (12")

- Stainless steel; 1/2" wide
- Holds heaters in place

Models: OCR & OCR+



Table Top Sterilizers

Models: OCM® (A3), OCR® (A4), OCR+® (A8) & Sentry® (A7) (continued)

RPI Part #PCT140
OEM Part #004040

INSTRUMENT TRAY (SMALL)

- Stainless steel
- 5" x 13" x 1"
- Tray can be used with larger tray (RPI Part #PCT141)

Fits: Chamber
Models: OCM & Sentry

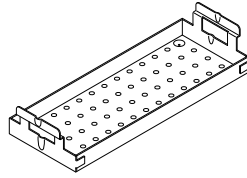

RPI Part #PCT141
OEM Part #004141

INSTRUMENT TRAY (LARGE)

- Stainless steel
- 6-1/2" x 13" x 1"
- Tray can be used with smaller tray (RPI Part #PCT140)

Fits: Chamber
Model: OCM

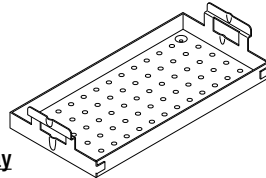

RPI Part #PCR188
OEM Part #004286

TRAY REST & SUPPORT ASSEMBLY

- Stainless steel • 4.5" x 13"
- Fits: Chamber
Model: OCM

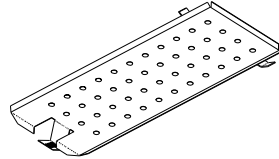

RPI Part #PCC121
OEM Part #004287

RESERVOIR COVER ASSEMBLY

- Fits: Outer casing
Models: OCM, OCR & OCR+

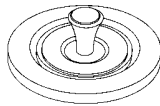

RPI Part #PCT157
OEM Part #004306

RESERVOIR TOP

- Fits: Rectangular reservoir
Model: OCM (Serial #16526 and above)

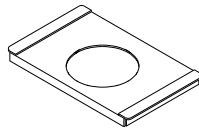

RPI Part #PCR155
OEM Part #004305

RESERVOIR ASSEMBLY

- Model: OCM (Serial #16526 and above)

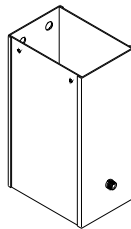

RPI Part #PCT142
New OEM Part #1539357
Old OEM Part #004429

INSTRUMENT TRAY (SMALL)

- Stainless steel
- 6-1/2" x 17" x 1"
- Tray can be used with larger tray (RPI Part #PCT143)

Fits: Chamber
Models: OCR & OCR+

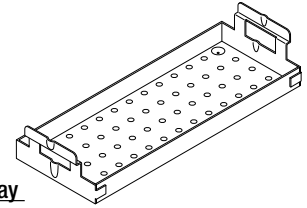

RPI Part #PCT143
New OEM Part #1539340
Old OEM Part #004430

INSTRUMENT TRAY (LARGE)

- Stainless steel
- 8" x 17" x 2-1/2"
- Tray can be used with smaller tray (RPI Part #PCT142)

Fits: Chamber
Models: OCR & OCR+

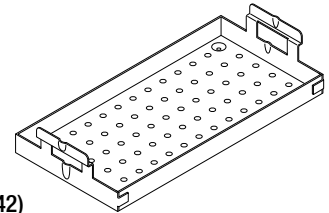

RPI Part #PCR189
OEM Part #004426

TRAY REST & SUPPORT ASSEMBLY

- Stainless steel • 6" x 17"
- Fits: Chamber
Models: OCR & OCR+

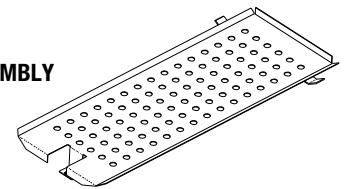

RPI Part #PCC121
OEM Part #004287

RESERVOIR COVER ASSEMBLY

- Fits: Outer casing
Models: OCM, OCR & OCR+

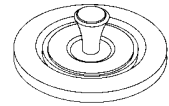

RPI Part #PCT158
OEM Part #004443

RESERVOIR TOP

- Fits: Rectangular reservoir
Models: OCR (Serial #15050 and above) & OCR+

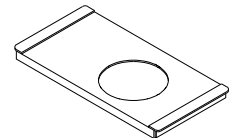

RPI Part #PCR156
OEM Part #004442

RESERVOIR ASSEMBLY

- Models: OCR (Serial #15050 and above) & OCR+

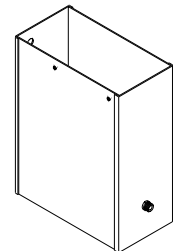

RPI Part #PCC055
OEM Part #004237

CONDENSER TUBE

- Includes compression fitting
 - Mounts in reservoir
 - ~8.5" tall
- Models: OCM, OCR, OCR+ & Sentry

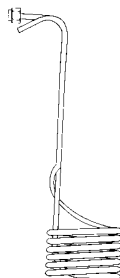

RPI Part #PCC056
OEM Part #002262

CONDENSER TUBE

- Includes compression fitting
 - Mounts in reservoir
 - ~10.5" tall
- Models: Old style OCM & OCR with round reservoir

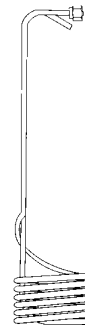

Service Tip

When referring to air valve housings, a round reservoir uses a pipe tap and a square reservoir uses a straight tap.

RPI Part #PCS036
OEM Part #004018

AIR RELEASE VALVE SEAT

- 6 per package
- Fits:** Air Valve Housing
- Models:** OCM, OCR, OCR+ & Sentry



RPI Part #PCV057
OEM Part #004318

AIR VALVE HOUSING ASSEMBLY

- 3/8-24 (straight thread)
- Fits:** Bellows
- Models:** OCM (Serial #34350 and above), OCR (Serial #15050 and above), OCR+ & Sentry (Serial #3902 and above)

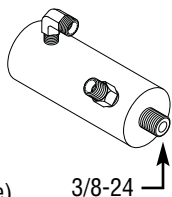

NOTE: PCS036 COMES INSTALLED

RPI Part #PCV058
OEM Part #002279

AIR VALVE HOUSING ASSEMBLY

- 1/8" MPT (tapered pipe thread)
- Includes compression fitting
- Fits:** Bellows
- Models:** OCM (Serial #1001 to 16525) & OCR (Serial #1001 to 2931)

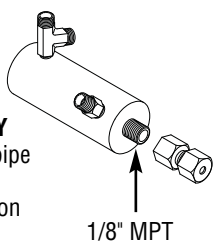

NOTE: PCS036 COMES INSTALLED

RPI Part #PCV059
OEM Part #011155

AIR VALVE HOUSING ASSEMBLY

- 1/8" MPT (tapered pipe thread)
- Includes compression fitting
- Fits:** Bellows
- Models:** OCM (Serial #16526 to 34349) & OCR (Serial #5671 to 15049)

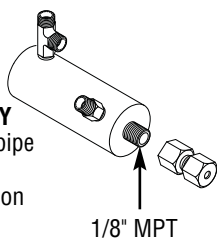

NOTE: PCS036 COMES INSTALLED

RPI Part #PCV060
OEM Part #004438

AIR VALVE HOUSING ASSEMBLY

- 3/8-24 (straight thread)
- Fits:** Bellows
- Model:** OCR (Serial #2932 to 5670)

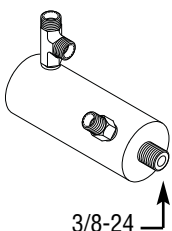

NOTE: PCS036 COMES INSTALLED

RPI Part #PCB001
OEM Part #004048

BELLOWS

- Fits:** Air Valve Housing
- Models:** OCM, OCR, OCR+ & Sentry

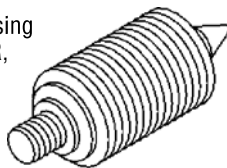

RPI Part #PCC005
OEM Part #004228

BELLOWS CAP

- Brass
- Requires Air Valve O-Ring (RPI Part #RPO354)

- Fits:** Air Valve Housing
- Models:** OCM, OCR, OCR+ & Sentry

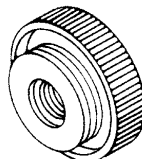

New RPI Part #RPO354
Old RPI Part #PC0034
OEM Part #004004
Industry Part #2-021

AIR VALVE O-RING

- 6 per package
- Material: Red Silicone
- Hardness: 70 Duro
- .926" ID x 1.066" OD x .070" C/S
- Fits:** Air Valve Housing Bellows Cap
- Models:** OCM, OCR, OCR+ & Sentry

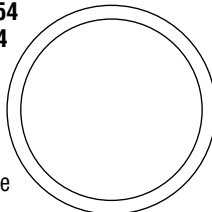

RPI Part #PCB002
OEM #002143

BELLOWS EXTENSION

- Fits:** Old style Bellows Cap
- Models:** OCM & OCR (Older machines only)

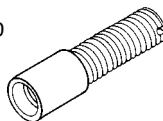

RPI Part #PCF009
New OEM Part #1881031
Old OEM Part #004326

FILTER (FILL LINE)

- 120-150 micron filter
- Fits:** Fill Tube
- Models:** OCM, OCR, OCR+ & Sentry

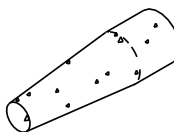

RPI Part #PCT010
New OEM Part #1881023
Old OEM Part #004371

FILL CHAMBER TUBE

- Fits:** Fill Filter and Chamber
- Models:** OCM & OCR (Serial #1001 and above)

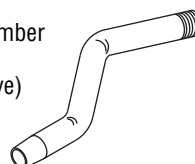

RPI Part #PCC119
OEM Part #004391

CAP-DRAIN TUBE

- Plated brass with Nylon® insert
- Fits:** Drain Tube Assembly
- Models:** OCM, OCR, OCR+ & Sentry



RPI Part #PCT144
OEM Part #4234

DRAIN TUBE

- Includes drain tube and compression fitting
- Also needed when replacing tube is Drain Tube Cap (RPI Part #PCC119)

- Fits:** Reservoir
- Model:** OCM

Drain Tube Cap (RPI Part #PCC119) is also needed when replacing the Drain Tube.

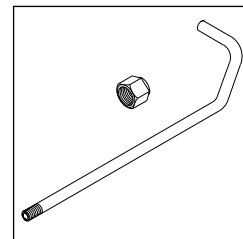

RPI Part #PCT145
OEM Part #002285

DRAIN TUBE

- Includes drain tube and compression fitting
- Also needed when replacing tube is Drain Tube Cap (RPI Part #PCC119)

- Fits:** Reservoir
- Model:** OCR with Serial #1001-5670

Drain Tube Cap (RPI Part #PCC119) is also needed when replacing the Drain Tube.

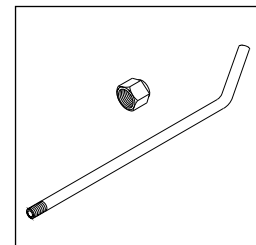

RPI Part #PCT146
OEM Part #004397

DRAIN TUBE

- Includes drain tube and compression fitting
- Also needed when replacing tube is Drain Tube Cap (RPI Part #PCC119)

- Fits:** Reservoir
- Models:** OCR with Serial #5671 and above & OCR+

Drain Tube Cap (RPI Part #PCC119) is also needed when replacing the Drain Tube.

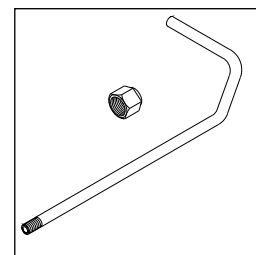
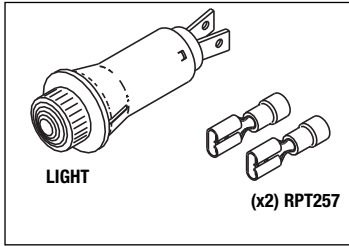

Table Top Sterilizers

Models: OCM® (A3), OCR® (A4), OCR+® (A8) & Sentry® (A7) (continued)

RPI Part #PCL028
OEM Part #004094

“HEAT ON” LIGHT (AMBER)
 • 125 VAC, 1/3 W
 • Includes all parts as shown
Fits: Control Panel
Model: OCM, OCR & OCR+



RPI Part #PCL027
OEM Part #004095

“POWER ON” LIGHT (RED)
 • 125 VAC, 1/3 W
 • Includes all parts as shown
Fits: Control Panel
Model: OCM, OCR & OCR+

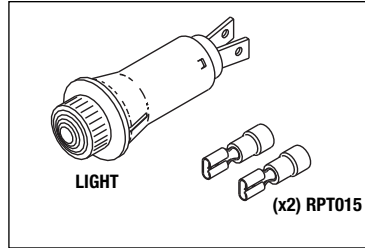

For a FREE copy of the
OCM/OCR/OCR+
RPI Troubleshooting Guide with
Exploded View, contact RPI
 or visit the RPI website at:
www.rpiparts.com
 and go to the "Tech Help"
 page to download the guide.

RPI Part #PCI078
OEM Part #004403

DOOR HANDLE INSERT
 • Stainless steel
Fits: Plastic Door Handle (Door Assembly)
Models: OCM & OCR

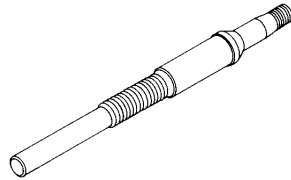

RPI Part #PCH077
OEM Part #004043

DOOR HANDLE
 • Black plastic
Fits: Door Handle Insert (Door Assembly)
Models: OCM & OCR

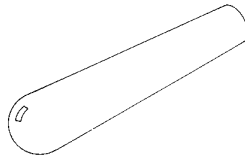

RPI Part #PCA117
OEM Part #012703

DOOR HANDLE ASSEMBLY
 • Includes all parts as shown
Fits: Cam on Door Assembly
Models: OCM & OCR

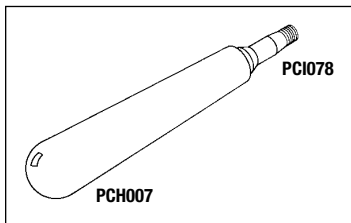

RPI Part #PCH163
OEM Part #004151

DOOR HINGE BLOCK
Fits: Right chamber flange
Model: OCM

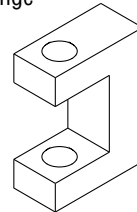

REPLACE THE HINGE PIN
 WHEN REPLACING THE
 DOOR HINGE BLOCK
 ASK FOR RPI PART #PCP165

RPI Part #PCH164
OEM Part #004351

DOOR HINGE BLOCK
Fits: Right chamber flange
Model: OCR

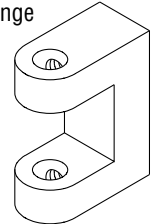

REPLACE THE HINGE PIN
 WHEN REPLACING THE
 DOOR HINGE BLOCK
 ASK FOR RPI PART #PCP166

RPI Part #PCP165
OEM Part #004024

HINGE PIN
Fits: Door Hinge Block
Model: OCM

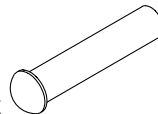

RPI Part #PCP166
OEM Part #004433

HINGE PIN
Fits: Door Hinge Block
Model: OCR

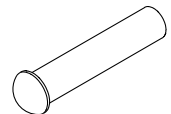

RPI Part #PCC159
OEM Part #004302

CATCH BLOCK ASSEMBLY
Fits: Left chamber flange
Model: OCM

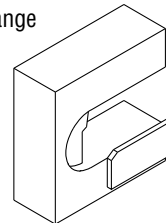

REPLACE THE DOOR CAM
 WHEN REPLACING THE
 CATCH BLOCK ASSEMBLY
 ASK FOR RPI PART #PCC161

RPI Part #PCC160
OEM Part #004444

CATCH BLOCK ASSEMBLY
Fits: Left chamber flange
Model: OCR

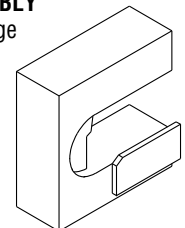

REPLACE THE DOOR CAM
 WHEN REPLACING THE
 CATCH BLOCK ASSEMBLY
 ASK FOR RPI PART #PCC162

RPI Part #PCC161
OEM Part #004149

DOOR CAM
Fits: Door
Model: OCM

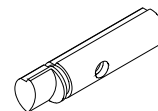

RPI Part #PCC162
OEM Part #004356

DOOR CAM
Fits: Door
Model: OCR

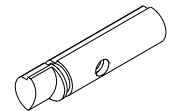

RPI Part #PCF011
OEM Part #002186

RUBBER FOOT

- 4 per package
 - Material: Black rubber
- Models:** OCM, OCR, OCR+ & Sentry

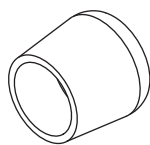

RPI Part #PCK137
OEM Part #004436 & 004297

FOOT KIT

- Includes (4) sets of parts as shown
- Fits:** Bottom of machine
Models: OCM, OCR, OCR+ & Sentry

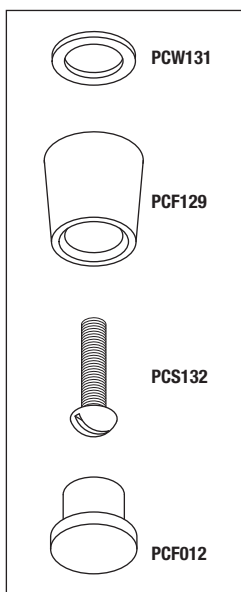

RPI Part #PCW131
OEM Part #004229

LEVELING WASHER

- 12 per package
 - Material: Stainless steel
 - Size: .44" ID x .63" OD x .05" thk
 - Also included in: Foot Kit (RPI Part #PCK137)
- Fits:** Foot Kit
Models: OCM, OCR, OCR+ & Sentry



RPI Part #PCF129
OEM Part #004120

PLASTIC TIP
RETAINER FOOT

- 4 per package
 - Material: Black plastic
 - Also included in: Foot Kit (RPI Part #PCK137)
- Fits:** Bottom of machine
Models: OCM, OCR, OCR+ & Sentry

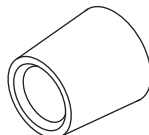

RPI Part #PCS132
OEM Part #3324295 & 090103

SCREW

- 12 per package
 - Material: Stainless steel
 - Size: #10-24 x 7/8" lg.; Slotted round head
 - Also included in: Foot Kit (RPI Part #PCK137)
- Models:** OCM, OCR, OCR+ & Sentry

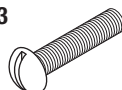

RPI Part #PCF012
OEM Part #004010

FOOT TIP INSERT

- 12 per package
 - Material: Black rubber
 - Also included in: Foot Kit (RPI Part #PCK137)
- Fits:** Plastic Tip Retainer Foot
Models: OCM, OCR, OCR+ & Sentry

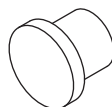

RPI Part #PCS133
OEM Part #090300

CASING SCREW

- 12 per package
 - Material: Stainless steel
 - Size: #10-24 x 3/8" lg.
 - Slotted binder head
- Fits:** Outer Casing
Models: OCM, OCR, OCR+ & Sentry

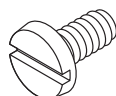

RPI Part #PCN136
OEM Part #004076

SPEEDNUT

- 10 per package
 - "U" type #10-24 thread
- Models:** OCM, OCR, OCR+ & Sentry



RPI Part #RPA032

OEM Part # (No OEM Part # Available)

THREADLOCKER 242

- 5 per package
- .02 fl. oz. (.5ml) per tube
- Prevents rust and corrosion
- Removable adhesive by Loctite®



RPI Part #RPT113

OEM Part # (No OEM Part # Available)

MAX REGISTER THERMOMETER

- Mercury
- Size: ~.40" OD x ~6.63" lg.
- Accuracy Rating: ±1 Division (±2°F)
- Dual scale: 150°F to 350°F / 65°C to 177°C
- Includes thermometer, and metal protective case
- Use for temperature verification in sterilizer

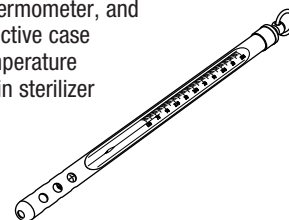

RPI Part #PCC003
OEM Part #004431

POWER CORD WITH CONNECTORS

- 8 ft.
- 16/3, 105°C; 13A @ 125VAC
- Plug Type: NEMA 5-15P
- Connection End: (1) #8 Ring Terminal and (2) 1/4" quick connect Terminal; .33" OD Cord

Fits: Tabletop Sterilizers

Models: OCM, OCR, OCR+ & Sentry

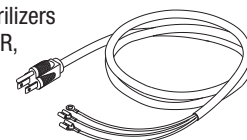

RPI Part #PCC004
OEM Part #004288

POWER CORD WITHOUT CONNECTORS

- 8 ft.
- 16/3, 105°C; 13A @ 125VAC
- Plug Type: NEMA 5-15P
- Connector Type: None; 0.33" OD Cord

Fits: Tabletop Sterilizers

Models: OCM, OCR, OCR+ & Sentry

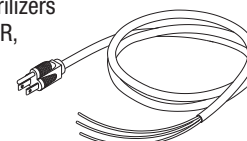

For a FREE copy of the OCM/OCR/OCR+ RPI Troubleshooting Guide with Exploded View, contact RPI or visit the RPI website at: www.rpiparts.com and go to the "Tech Help" page to download the guide.

RPI Part #PCG065
New OEM Part #1539241
Old OEM Part #019613

DOOR GASKET

- 9.875" OD
- When replacing this gasket, it is also a good time to replace the Door Spacer (RPI Part# PCS067)

Fits: Door
Model:
 Validator 8 (AB)

REPLACE THE DOOR SPACER
 AT THE SAME TIME!
 ASK FOR RPI PART #PCS067

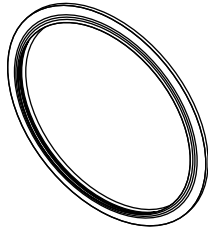

RPI Part #PCP200
New OEM Part #1539514
Old OEM Part #021812

INSULATION PAD

- Ceramic fiber paper (white)
- Fits:** Between gasket retainer and door body
- Model:** Validator 8 (AB)

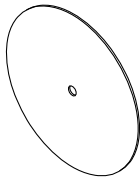

RPI Part #PCS067
New OEM Part #3322281
Old OEM Part #019678

SPACER (DOOR)

- With slots for easy installation
- Fits:** Door
- Models:**
 Validator 8 (AB) & 10 (AA)

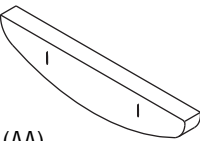

RPI Part #PCG066
New OEM Part #1539407
Old OEM Part #019763

DOOR GASKET

- 11.312" OD
- When replacing this gasket, it is also a good time to replace the Door Spacer (RPI Part# PCS067)

Fits: Door
Model:
 Validator 10 (AA)

REPLACE THE DOOR SPACER
 AT THE SAME TIME!
 ASK FOR RPI PART #PCS067

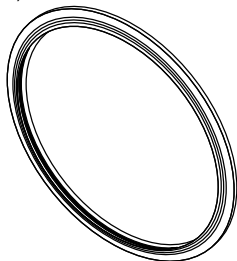

RPI Part #PCP201
New OEM Part #1539720
Old OEM Part #019832

INSULATION PAD

- Ceramic fiber paper (white)
- Fits:** Between gasket retainer and door body
- Model:** Validator 10 (AA)

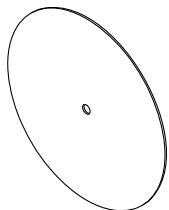

RPI Part #PCK220
OEM Part #1539241 (Door Gasket only)

STERILIZER PM KIT

- Includes all parts as shown
- Model:** Validator 8 (AB)

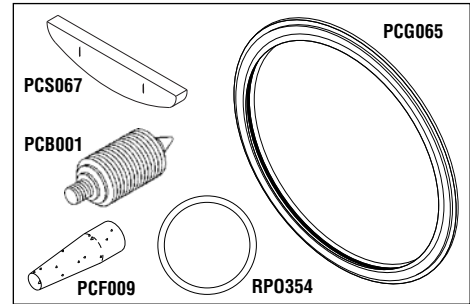

ALL PARTS IN KIT,
 ALSO SOLD SEPARATELY.

RPI Part #PCK221
OEM Part #1539407 (Door Gasket only)

STERILIZER PM KIT

- Includes all parts as shown
- Model:** Validator 10 (AA)

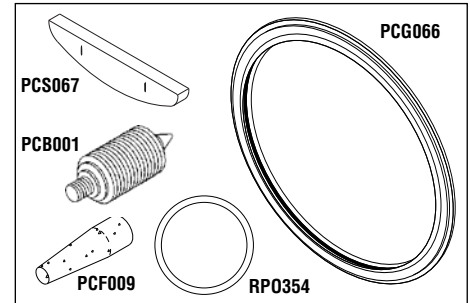

ALL PARTS IN KIT,
 ALSO SOLD SEPARATELY.

RPI Part #PCK224
OEM Part #011047

BELLOWS KIT

- Includes all parts as shown
- Models:** Validator 8 (AB) & 10 (AA)

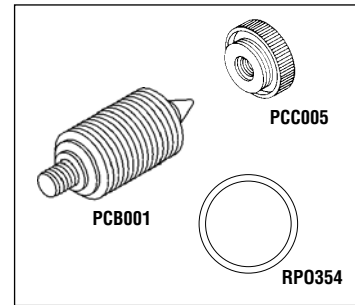

ALL PARTS IN KIT,
 ALSO SOLD SEPARATELY.

RPI Part #PCK225
OEM Part #004439

FILTER & TUBE KIT

- Includes all parts as shown
- Models:** Validator 8 (AB) & 10 (AA)

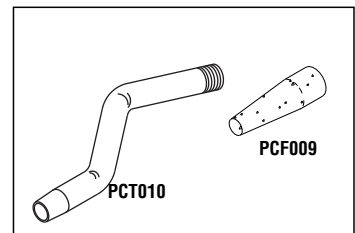

ALL PARTS IN KIT,
 ALSO SOLD SEPARATELY.

RPI Part #PCV052
OEM Part #004146

SAFETY VALVE (35 PSI)

- 1/2" MPT x 1/2" FPT
- Cracking Pressure: 35 PSI
- Fits:** Chamber
- Model:** Validator 8 (AB)
 (Serial #1001-9771)

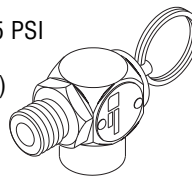

RPI Part #AMV097
New OEM Part #4205055
Old OEM Part #1881007

SAFETY VALVE (38 PSI)

- Cracking pressure: 38 PSI
- 1/2" MPT x 1/2" FPT
- Mounts to chamber
- Models:** Validator 8 (AB) & 10 (AA)

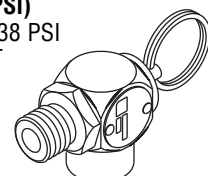

For a FREE copy of the Validator® 8 & 10 RPI Troubleshooting Guide with Exploded View, contact RPI or visit the RPI website at: www.rpiparts.com and go to the "Tech Help" page to download the guide.

Table Top Sterilizers

Models: Validator® 8 (AB) & 10 (AA) (continued)

RPI Part #PCR085
OEM Part #019698

WATER RESERVOIR

- Includes Elbow Fitting (1/4" Barb) (RPI Part #RPF686) for drain
 - Mounts to right side of chamber
- Models:** Validator 8 (AB) & 10 (AA)

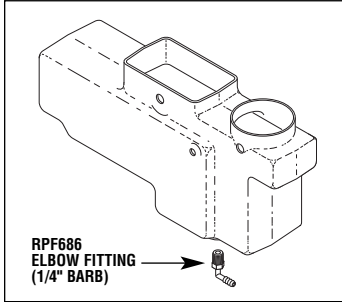

RPI Part #PCC176
OEM Part #1881106

CONDENSATION COIL WITH COMPRESSION FITTING

- Fits:** Reservoir assembly
- Models:** Validator 8 (AB) & 10 (AA)

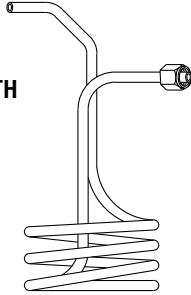

RPI Part #MIS015
OEM Part #1881015

MICRO SWITCH (DOOR)

- 1/2 A @ 125 VDC; 1/4 A @ 250 VDC; 1/2 HP 15 A 125, 250 VAC
 - Includes door switch and (2) 3/16" Quick Disconnect Terminals (RPI Part #RPT257)
- Models:** Validator 8 (AB) & Validator 10 (AA)

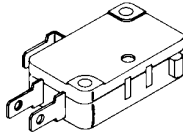

RPI Part #PCS036
OEM Part #004018

AIR RELEASE VALVE SEAT

- 6 per package
- Fits:** Air Valve Housing
- Models:** Validator 8 (AB) units above S/N 10195 & Validator 10 (AA) units above S/N 2258



RPI Part #RP0353
Industry Part #2-112

O-RING

- 12 per package
 - Material: Buna-N (Nitrile)
 - Hardness: 70 Duro
 - .487" ID x .693" OD x .103" C/S
- Models:** Validator 8 (AB) units above S/N 10195 & Validator 10 (AA) units above S/N 2258

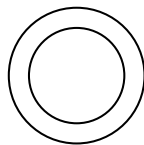

RPI Part #PCK125

OEM Part # (No OEM Part # Available)

AIR RELEASE BELLOWS PM KIT

- Includes all parts as shown
- Fits:** Control Valve Block
- Models:** Validator 8 (AB) units above S/N 10195 & Validator 10 (AA) units above S/N 2258

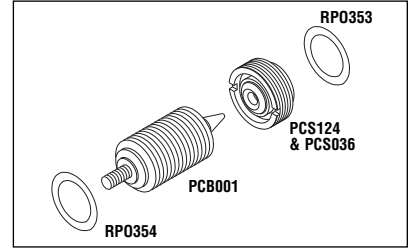

ALL PARTS IN KIT,
ALSO SOLD SEPARATELY

RPI Part #PCK111
OEM Part #025580

AIR RELEASE VALVE SEAT KIT

- Includes all parts as shown
- Fits:** Air Release Section of Control Valve Body
- Models:** Validator 8 (AB) units above S/N 10195 & Validator 10 (AA) units above S/N 2258

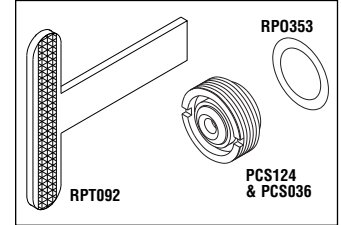

ALL PARTS IN KIT,
ALSO SOLD SEPARATELY

RPI Part #PCS124
OEM Part #004018

VALVE SEAT & BODY

- Brass with Teflon® seat
 - Includes all parts as shown
- Fits:** Air Release Section of Control Valve Body
- Models:** Validator 8 (AB) units above S/N 10195 & Validator 10 (AA) units above S/N 2258

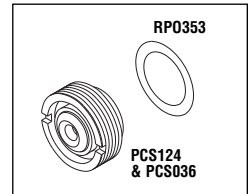

ALL PARTS IN KIT,
ALSO SOLD SEPARATELY

RPI Part #RPT092
OEM Part #022060

VALVE SEAT WRENCH

- Stainless steel
 - Use tool to remove and install valve seat and body
- Fits:** Slot in valve seat
- Models:** Validator 8 (AB) units above S/N 10195 & Validator 10 (AA) units above S/N 2258

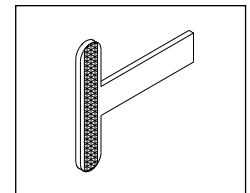

RPI Part #RPT271
OEM Part # (No OEM Part # Available)

VALVE SEAT TOOL

- 5/8" Hex size is 3-3/8" lg.; 300 series stainless steel
 - Use tool to remove or install Validator 8 (AB) & 10 (AA) Valve Seat Body (RPI Part #PCS124) and to remove/install Seat (RPI Part #PSC036)
- Models:** Validator 8 (AB) & 10 (AA) only

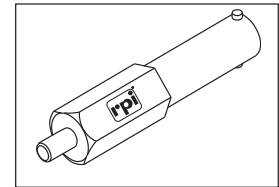

RPI Part #PCW178
OEM Part #024982

RESERVOIR WASHER (SILICONE)

- Fits:** Plastic reservoir assembly
- Models:** Validator 8 (AB) & 10 (AA)



RPI Part #PCW177
New OEM Part #1539563
Old OEM Part #024983

MANIFOLD WASHER (SILICONE)

- Fits:** Manifold assembly
- Models:** Validator 8 (AB) & 10 (AA)



Service Tip

To avoid damaging the autoclave, use the Spanner Nut (RPI Part #ILS014) and the Double Ended Spanner Wrench (RPI Part #RPT501) when replacing the Vent Plunger Kit (RPI Part #PCK102), Vent Plunger Kit (RPI Part #PCK106) and Fill Plunger Kit (RPI Part #PCK110).

RPI Part #ILS014

OEM Part # (No OEM Part # Available)

SPANNER NUT

- ID: .525", HEX: .875", THK: .250"
- Stainless steel
- See "Service Tip" above

Fits: Fill, Dump and Vent Solenoid Valve

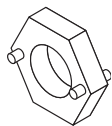

RPI Part #RPT501

OEM Part # (No OEM Part # Available)

DOUBLE ENDED SPANNER WRENCH

- .875" HEX x ~7" lg.; Stainless steel
- See "Service Tip" above

Fits: Fill, Dump and Vent Solenoid Valve

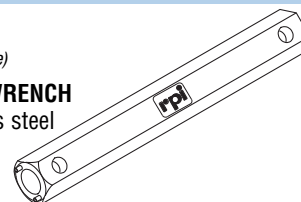

RPI Part #PCK102

OEM Part #026356

VENT PLUNGER KIT

- Includes all parts as shown
- See "Service Tip" above

Fits: Valve Operator-Vent Assembly

Models: Validator 8 (AB) & 10 (AA)

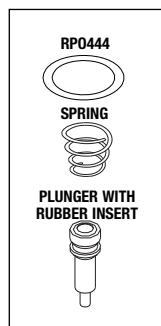

RPI Part #PCK106

OEM Part #026358

DUMP PLUNGER KIT

- Includes all parts as shown
- See "Service Tip" above

Fits: Valve Operator-Dump Assembly

Models: Validator 8 (AB) & 10 (AA)

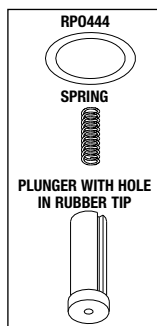

RPI Part #PCK110

OEM Part #026357

FILL PLUNGER KIT

- Includes all parts as shown
- See "Service Tip" above

Fits: Valve Operator-Fill Assembly

Models: Validator 8 (AB) & 10 (AA)

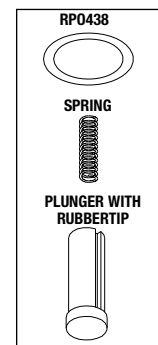

RPI Part #PCB001

OEM Part #004048

BELLOWS

Fits: Air Valve Housing
Models: Validator 8 (AB) & 10 (AA)

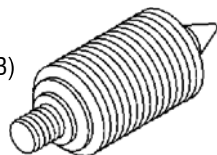

RPI Part #PCF009

New OEM Part #1881031
Old OEM Part #004326

FILTER (FILL LINE)

• 120 - 150 micron
Fits: Fill Chamber Tube
Models: Validator 8 (AB) & 10 (AA)

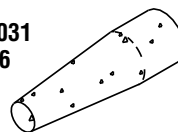

RPI Part #PCF180

OEM Part #1881122

FRONT LEVELING FOOT

• 2 per package
• 1/4-20 x 1" lg. stem
Fits: Bottom front assembly
Models: Validator 8 (AB) & 10 (AA)

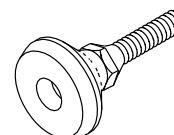

RPI Part #PCC005

OEM Part #004228

BELLOWS CAP (BRASS)

• Requires Air Valve O-Ring (RPI Part #RP0354)

Fits: Air Valve Housing
Models: Validator 8 (AB) & 10 (AA)

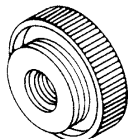

RPI Part #PCT010

New OEM Part #1881023
Old OEM Part #004371

FILL CHAMBER TUBE

Fits: Fill Filter and Chamber
Models: Validator 8 (AB) & 10 (AA)

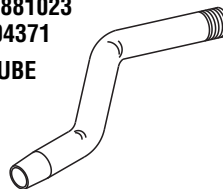

RPI Part #PCF179

OEM Part #1539308

RUBBER FOOT ASSEMBLY

• Includes (2) sets of parts as shown
Fits: Bottom and rear assembly
Models: Validator 8 (AB) & 10 (AA)

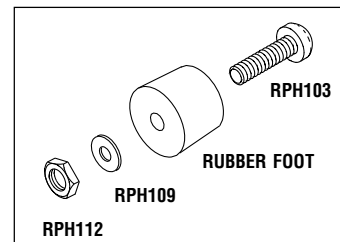

New RPI Part #RP0354

OEM Part #004004
Industry Part #2-021

AIR VALVE O-RING

• 6 per package;
Material: Red Silicone;
Hardness: 70 Duro
• .926" ID x 1.066" OD x .070" C/S
Fits: Air Valve Housing Bellows Cap
Models: Validator 8 (AB) & 10 (AA)

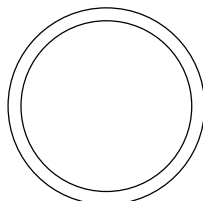

RPI Part #PCS184

OEM Part #019751

VALVE FILL STEM

• Thread size: #5-40
Fits: Between Tank Assembly and Fill Valve
Models: Validator 8 (AB) & 10 (AA)

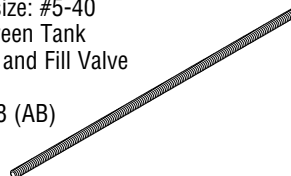

Table Top Sterilizers

Models: Validator® 8 (AB) & 10 (AA) (continued)

RPI Part #PCT093
OEM Part #019822

PRESSURE SENSOR TUBE

- Includes all parts as shown

Fits: Between Valve Block and Pressure Transducer

Models: Validator 8 (AB) & 10 (AA)

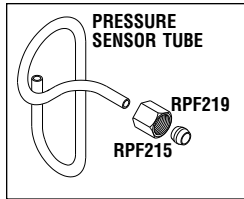

RPI Part #PCH095
OEM Part #019813

HEATER & PLUG ASSEMBLY

- Sheathing: Silicone
- If using on newer PCB, connector must be removed

Fits: Heater plate
Model: Validator 8 (AB)

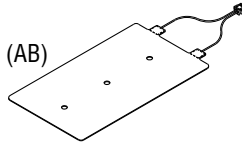

RPI Part #PCH096
OEM Part #019769

HEATER & PLUG ASSEMBLY

- Sheathing: Silicone
- 1360 W, 120 VAC, ~10Ω

Fits: Heater plate
Model: Validator 10 (AA)

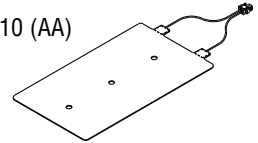

RPI Part #RPK282
OEM Part # (No OEM Part Available)

(No OEM Part Available)

PRESSURE TUBE KIT

- Includes all parts as shown
 - Some older machines may need a longer piece of tubing (RPI Part #RPT663) which is sold by the foot
 - 500°F maximum temperature
 - Silicone, Translucent natural color for visual contact with the flow
 - Made from FDA-sanctioned ingredient
- Fits:** PC Board to Pressure Sensor Tube
Models: Validator 8 (AB) & 10 (AA)

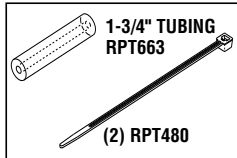

RPI Part #PCK149
OEM Part # (No OEM Part Available)

PRESSURE/TEMPERATURE CONVERSION KIT

- RPI steam sensor (RPI Part #PCS100) can only be used with RPI pressure/temperature Board (RPI Part #PCB098)
 - Includes all parts as shown
- Fits:** PCB mounts on press/temp module bracket and sensor connects to lower back of chamber or tee block and plugs into PCB
Models: Validator 8 (AB) & 10 (AA)

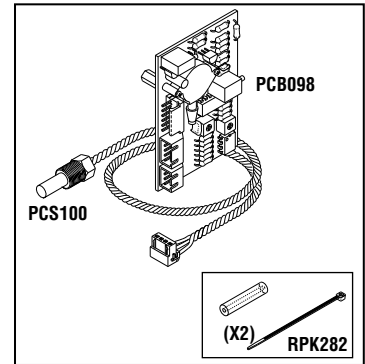

RPI Part #PCT097
OEM Part #019615

OVERHEAT THERMOSTAT

- Opens @ 370°F
- Fits:** Pressure Plate
Models: Validator 8 (AB) & 10 (AA)

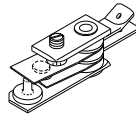

RPI Part #PCA084
OEM Part #019779

TRIAC ASSEMBLY

- Includes triac with connector
- Fits:** Power supply board
Models: Validator 8 (AB) & 10 (AA)

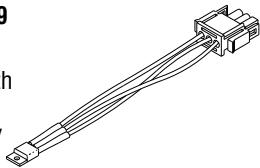

RPI Part #PCB098
OEM Part # (No OEM Part Available)

PRESSURE/TEMPERATURE BOARD

- RPI pressure/temperature board (RPI Part #PCB098) can only be used with RPI steam sensor (RPI Part #PCS100)
- Fits:** Bracket - temperature/sensor module
Models: Validator 8 (AB) & 10 (AA)

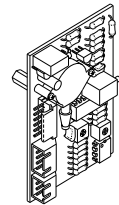

RPI Part #PCS100
OEM Part # (No OEM Part Available)

STEAM SENSOR ASSEMBLY

- Includes sensor and connector
 - RPI steam sensor (RPI Part #PCS100) can only be used with RPI pressure/temperature board (RPI Part #PCB098)
- Fits:** Lower back of sterilizer chamber or tee block
Models: Validator 8 (AB) & 10 (AA)

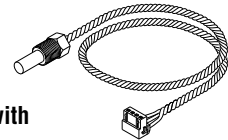

RPI Part #PCS099
OEM Part #019855

SURFACE HEAT SENSOR

- Includes sensor and JST connector
 - 10K Ω @ 25°C
- Fits:** Between pressure plate and overheat thermostat
Models: Validator 8 (AB) & 10 (AA)

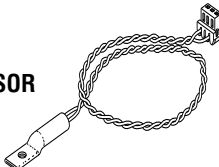

RPI Part #PCC108
OEM Part #019691

TEMP/PRESS MODULE CABLE

- Fits: Between Temperature/Pressure Board and Power Supply Board
- Models:** Validator 8 (AB) & 10 (AA)

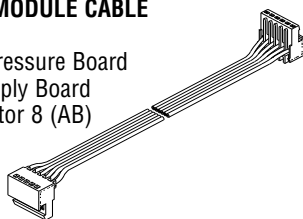

RPI Part #PCK214
OEM Part # (No OEM Part Available)

STEAM SENSOR UPGRADE KIT

If servicing the Steam Sensor plumbing of the Validator 8 or 10 with the Steam Sensor Body located on the outside of the chamber with plumbing as shown below in Figures A or B, it is necessary to replace the plumbing with this upgrade Kit (RPI Part #PCK214). This Kit includes the Block that accommodates the larger-sized Steam Sensor Body that is currently sold by RPI and the OEM.

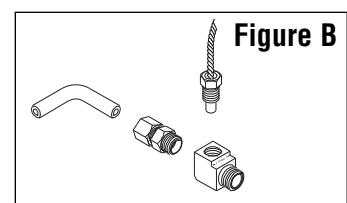
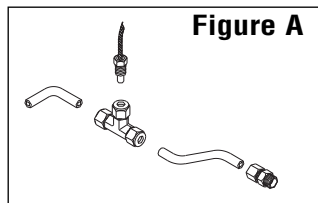
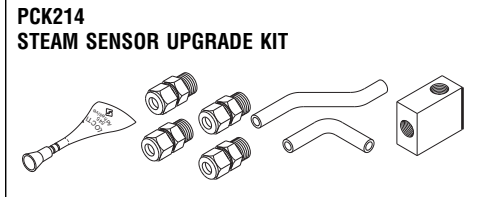

RPI Part #RPK432
OEM Part #3003683

DRAIN TUBE ASSEMBLY KIT (SMALL)

- Fitting: Acetal; Tubing: Clear Polyethylene (.250" OD x .035" Wall)
 - Includes: Drain Tube, Quick Connect Male Fitting-White (RPI Part #RPF429), O-ring (RPI Part #RPO306), and approximately 50 inches of Polyethylene tubing (RPI Part #RPT276)
- Fits:** Front Panel/Female Quick Connect Fitting-White (RPI Part #RPF428)
Model: Validator 10 (AA)

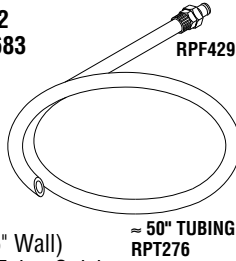

RPI Part #RPF429
OEM Part #1539399

MALE QUICK CONNECT FITTING (WHITE)

- Tubing size: .250" OD x .170" ID (6 x 4.3 mm); Length: 1.15" lg.
 - Body and valve material: Acetal; Seal material: Buna-N
 - Panel mount ferrules polytube fitting
 - Operating temperature: -40°F - 180°F
 - Working pressure: Vacuum to 120 PSI
- Fits:** Female Quick Connect on Front Panel (RPI Part #RPF428)/Drain Tube Assembly Kit - Small (RPI Part #RPK432)
Model: Validator 10 (AA)



RPI Part #RPF428
OEM Part #1881130

FEMALE QUICK CONNECT FITTING (WHITE)

- Tubing size: .250" OD x .170" ID; Flow: 1/8"; 1.720" lg.
 - Body and valve material: Acetal; Seal material: Buna-N
 - Panel mount ferrules polytube fitting
 - Operating temperature: -40°F - 180°F
 - Working pressure: Vacuum to 120 PSI
- Fits:** Front Panel/Drain Tube Assembly Kit - Small (RPI Part #RPK432) and Male Quick Connect Fitting (RPI Part #RPF429)
Model: Validator 10 (AA)

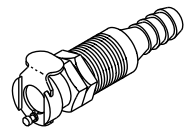

RPI Part #RPI268
OEM Part # (No OEM Part # Available)

CHAMBER INSULATION

- 14-1/4" x 28" x 1/4" thk
 - White ceramic fiber paper
 - Cut to fit 8" dia. chambers
- Fits:** Wraps around chamber of autoclave
Model: Validator 8 (AB)

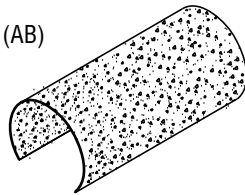

RPI Part #RPI269
OEM Part # (No OEM Part # Available)

CHAMBER INSULATION

- 18-1/4" x 33-3/4" x 1/4" thk
 - White ceramic fiber paper
 - Cut to fit 10" dia. chambers
- Fits:** Wraps around chamber of autoclave
Model: Validator 10 (AA)

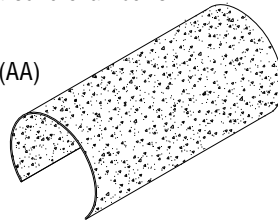

RPI Part #PCT142
New OEM Part #1539357
Old OEM Part #004429

INSTRUMENT TRAY (SMALL)

- Stainless steel
 - 6-1/2" x 17" x 1"
- Fits:** Chamber
Model: Validator 10 (AA)

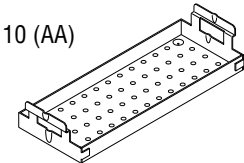

RPI Part #PCB123
New OEM Part #3000119
Old OEM Part #004080

BAND (10")

- Stainless steel
 - 1/2" wide
 - Holds heaters in place
- Fits:** 8" chamber
Model: Validator 8 (AB)

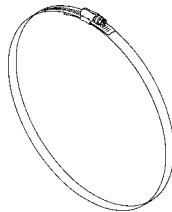

RPI Part #PCB122
New OEM Part #1539647
Old OEM Part #004325

BAND (12")

- Stainless steel
 - 1/2" wide
 - Holds heaters in place
- Fits:** 10" chamber
Model: Validator 10 (AA)

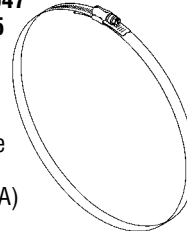

RPI Part #PCT143
New OEM Part #1539340
Old OEM Part #004430

INSTRUMENT TRAY (LARGE)

- Stainless steel
 - 8" x 17" x 2-1/2"
 - Smaller tray (RPI Part #PCT142) can be stacked on top
- Fits:** Chamber
Model: Validator 10 (AA)

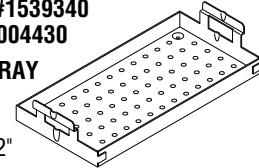

RPI Part #PCC004
OEM Part #004288

POWER CORD WITHOUT CONNECTORS

- 8 ft. lg. with outer jacket stripped 6"
 - 15 A @ 120 VAC; 90°C
 - Plug: NEMA 5-15; Cord: HSJO 16/3
- Fits:** Tabletop Sterilizers
Models: Validator 8 (AB) & 10 (AA)

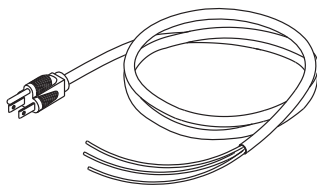

RPI Part #PCS170
OEM Part #1539936

BLACK COVER SCREW

- 12 per package
 - #10-24 x 3/8" lg.
 - Stainless steel with black zinc plating
- Fits:** Outer cover
Models: Validator 8 (AB) & 10 (AA)



RPI Part #PCN136
OEM Part #004076

SPEEDNUT

- 10 per package
 - "U" type #10-24 thread
- Models:** Validator 8 (AB) & 10 (AA)



RPI Part #RPT113
OEM Part # (No OEM Part # Available)

MAX REGISTER THERMOMETER

- Mercury
- Length: 5-1/2"
- Accuracy Rating: ±1 Division (±2°F)
- Range: 150°F to 350°F
- Includes thermometer, and metal protective case
- Use for temperature verification in sterilizer

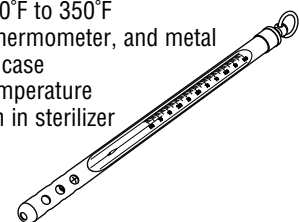

RPI Part #PCG065
New OEM Part #1539241
Old OEM Part #019613

DOOR GASKET

- 9.875" OD
- When replacing this gasket, it is also a good time to replace the Spacer (Door) (RPI Part #PCS067)

Fits: Door

Model: Validator Plus 8

REPLACE THE DOOR SPACER AT THE SAME TIME!
 ASK FOR RPI PART #PCS067



PCG065
 CROSS SECTION
 SHOWN ACTUAL SIZE

RPI Part #PCP200
New OEM Part #1539514
Old OEM Part #021812

INSULATION PAD

- Ceramic fiber paper (white)

Fits: Between gasket retainer and door body

Model: Validator Plus 8

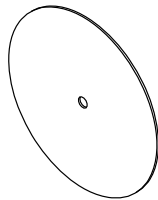

RPI Part #PCG066
New OEM Part #1539407
Old OEM Part #019763

DOOR GASKET

- 11.312" OD
- When replacing this gasket, it is also a good time to replace the Spacer (Door) (RPI Part #PCS067)

Fits: Door

Model: Validator Plus 10

REPLACE THE DOOR SPACER AT THE SAME TIME!
 ASK FOR RPI PART #PCS067

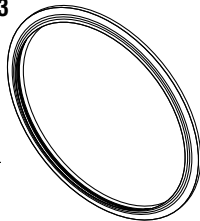

PCG066
 CROSS SECTION
 SHOWN ACTUAL SIZE

RPI Part #PCP201
New OEM Part #1539720
Old OEM Part #019832

INSULATION PAD

- Ceramic fiber paper (white)

Fits: Between gasket retainer and door body

Model: Validator Plus 10

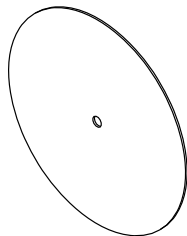

RPI Part #PCK222
OEM Part #153924 (Door Gasket only)

STERILIZER PM KIT

- Includes all parts as shown
- Model:** Validator Plus 8

ALL PARTS IN KIT,
 ALSO SOLD SEPARATELY.

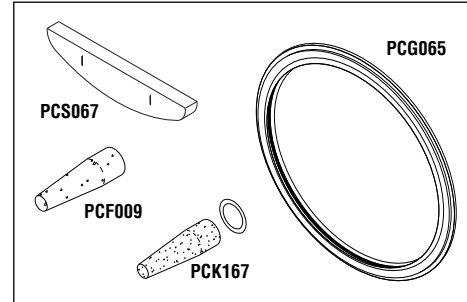

RPI Part #PCK223
OEM Part #1539407 (Door Gasket only)

STERILIZER PM KIT

- Includes all parts as shown
- Model:** Validator Plus 10

ALL PARTS IN KIT,
 ALSO SOLD SEPARATELY.

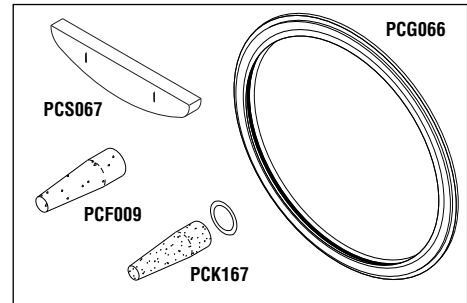

RPI Part #PCK225
OEM Part # (No OEM Part # Available)

FILTER & TUBE KIT

- Includes all parts as shown
- Model:** Validator Plus 8 & Plus 10

ALL PARTS IN KIT,
 ALSO SOLD SEPARATELY.

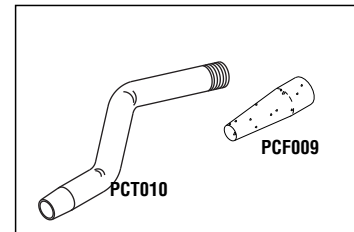

RPI Part #PCS067
New OEM Part #3322281
Old OEM Part #019678

SPACER (DOOR)

- With slots for easy installation

Fits: Door

Models: Validator Plus 8 & Plus 10

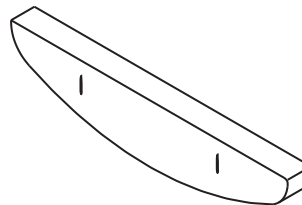

RPI Part #AMV097
New OEM Part #4205055
Old OEM Part #1881007

SAFETY VALVE (38 PSI)

- Cracking pressure: 38 PSI
- 1/2" MPT x 1/2" FPT

Mounts to chamber

Models: Validator Plus 8 & Plus 10

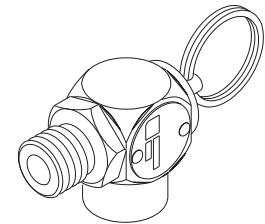

Visit the RPI website:
www.rpiparts.com

Table Top Sterilizers

Models: Validator Plus® 8 (AC) & Plus 10 (AD) (continued)

RPI Part #PCT192
OEM Part #1521512

OVERHEAT THERMOSTAT

- Opens @ 356°F ± 8°F
- Closes @ 326°F ± 10°F
- Automatic reset

Fits: Cable Assembly /Chamber

Models: Validator Plus 8 & Plus 10

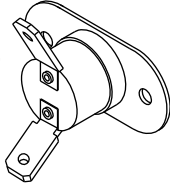

RPI Part #PCA185
OEM Part #1520084

SURFACE SENSOR ASSEMBLY

- Sensor opens @ 311°F ± 8°F
- Sensor closes @ 280°F ± 8°F

Fits: Sensor bracket

Models: Validator Plus 8 & Plus 10

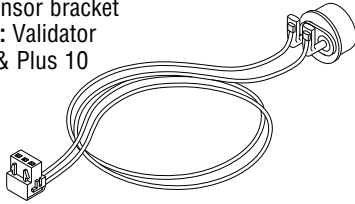

RPI Part #PCS195
OEM Part #1520019

STEAM SENSOR ASSEMBLY

- 1/4" MPT
- Fits:** Lower back of sterilizer chamber

Models: Validator Plus 8 & Plus 10

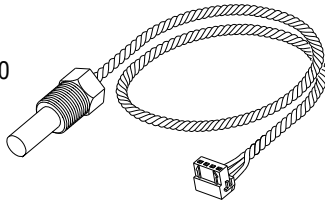

RPI Part #PCC176
OEM Part #1881106

CONDENSATION COIL WITH COMPRESSION FITTING

Fits: Reservoir assembly

Models: Validator Plus 8 & Plus 10

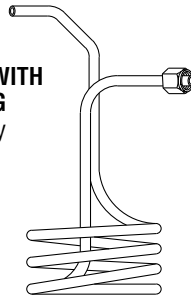

RPI Part #RPA430
OEM Part #1520118

WATER LEVEL ASSEMBLY

- 1/2-13 bulkhead fitting
- Material: Polysulfone
- Switch: 20VA SPST

Models: Validator 8 Plus & Plus 10

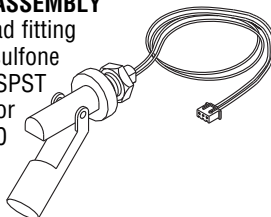

RPI Part #PCH190
New OEM Part #3335085
Old OEM Part #9432097

HEATER & PLUG ASSEMBLY

- Sheathing: Orange Silicone
- Pins: 1-3 (~17Ω); 1-4 (~34Ω); 3-4 (~17Ω)
- 920 W, 180 VAC

Fits: Pressure Plate Assembly

Model: Validator Plus 8

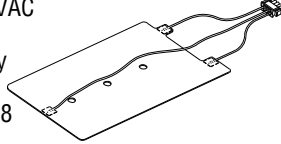

RPI Part #PCH191
New OEM Part #3335077
Old OEM Part #9432105

HEATER & PLUG ASSEMBLY

- Sheathing: Silicone
- Pins: 1-3 (~12Ω); 1-4 (~24Ω); 3-4 (~12Ω)
- 1360 W, 180 VAC

Fits: Pressure Plate Assembly

Model: Validator Plus 10

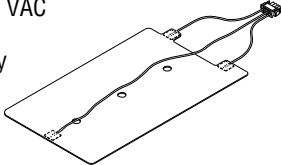

RPI Part #MIS015
OEM Part #1881015

MICRO SWITCH (DOOR)

- 1/2 A @ 125 VDC;
- 1/4 A @ 250 VDC; 1/2 HP 15 A 125, 250 VAC
- Includes door switch and (2) 3/16" Quick Disconnect Terminals (RPI Part #RPT257)

Models: Validator Plus 8 & Plus 10

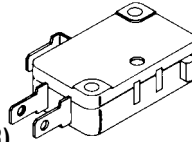

RPI Part #PCK171
OEM Part #1539449

COUPLING-VENT/CONDENSER KIT

- Includes all parts as shown
- Fits:** Reservoir

Models: Validator Plus 8 & Plus 10

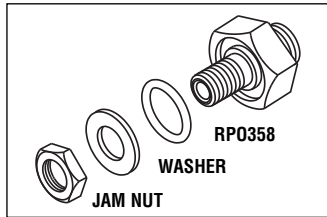

RPI Part #RPO358
New OEM Part #1881072
Old OEM Part #004840
Industry Part #2-113

O-RING

- 6 per package
- .487" ID x .693" OD x .103" C/S
- Material: EPDM

Fits: Coupling-Vent/Condenser

Models: Validator Plus 8 & Plus 10

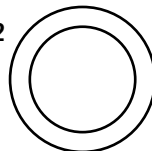

RPI Part #PCK193
OEM Part #3326381

FUSE HOLDER KIT (SMALL)

- Includes (2) fuse holder, (2) fuse carrier (2) fuse (RPI Part #RPF259), and (2) plastic nut and wire assemblies

Fits: Back panel

Model: Validator Plus 8

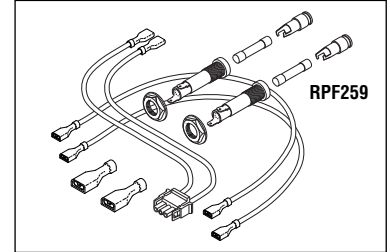

RPI Part #PCK194
OEM Part #3325664

FUSE HOLDER KIT (LARGE)

- Includes (2) fuse holder, (2) fuse carrier (2) fuse (RPI Part #RPF259) and (2) metal nut and wire assemblies

Fits: Back panel

Model: Validator Plus 10

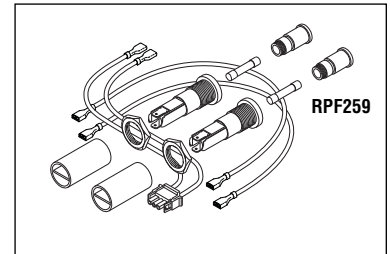

RPI Part #RPF259
OEM Part # (No OEM Part # Available)

FUSE (20A, 250V) - FAST ACTING

- 5 per package
- Type: ABC Ceramic
- Size: 1/4" dia. x 1-1/4" lg.

Fits: Fuse Holder

Models: Validator Plus 8 & Plus 10

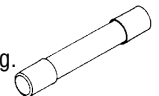

RPI Part #PCW177
New OEM Part #1539563
Old OEM Part #024983

MANIFOLD WASHER (SILICONE)

Fits: Float to reservoir

Models: Validator Plus 8 & Plus 10



RPI Part #RPO343
OEM Part #9435546
Industry Part #AS568-011

O-RING

- 12 per package
- .301" ID x .441" OD x .070" C/S
- Material: Red Silicone

Fits: Seals Reservoir Filter to Coupling

Models: Validator Plus 8 & Plus 10



Service Tip

To avoid damaging the autoclave, use the Spanner Nut (RPI Part #ILS014) and the Double Ended Spanner Wrench (RPI Part #RPT501) when replacing the Fill/ent Plunger Kit (RPI Part #PCK202), Dump Plunger Kit (RPI Part #PCK203) and Bellows Plunger Kit (RPI Part #PCK204).

RPI Part #ILS014
OEM Part # (No OEM Part # Available)

SPANNER NUT

- ID: .525", HEX: .875", THK: .250"
- Stainless steel
- See "Service Tip" above

Fits: Fill, Dump and Vent Solenoid Valve

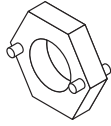

RPI Part #RPT501
OEM Part # (No OEM Part # Available)

DOUBLE ENDED SPANNER WRENCH

- .875" HEX x ~7" lg.; Stainless steel
- See "Service Tip" above

Fits: Fill, Dump and Vent Solenoid Valve

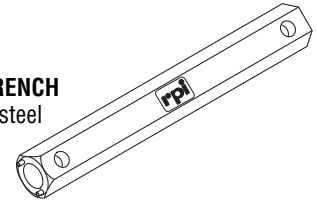

RPI Part #PCK202
OEM Part #5151787

FILL/VENT PLUNGER KIT

- Includes all parts as shown
- Fits:** Fill/Vent solenoid valve

Models: Validator Plus 8 & Plus 10

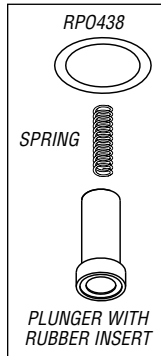

RPI Part #PCK203
OEM Part #5151803

DUMP PLUNGER KIT

- Includes all parts as shown
- Fits:** Dump solenoid valve

Models: Validator Plus 8 & Plus 10

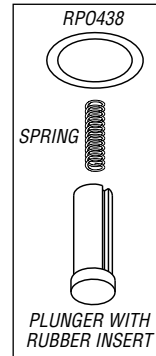

RPI Part #PCK204
OEM Part #5151795

BELLOWS PLUNGER KIT

- Includes all parts as shown
- Fits:** Bellows solenoid valve

Models: Validator Plus 8 & Plus 10

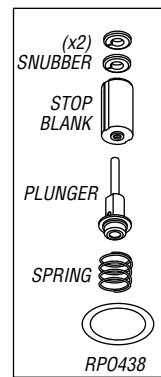

RPI Part #PCF009
New OEM Part #1881031
Old OEM Part #004326

FILTER (FILL LINE)

- 120 - 150 micron
- Fits:** Fill Chamber Tube

Models: Validator Plus 8 & Plus 10

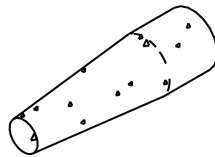

RPI Part #PCK167
OEM Part #9432311

RESERVOIR FILTER KIT

- Includes all parts as shown
- 120-150 micron filter with 3/8-24 female insert.

Fits: Fill Coupling Vent/Condenser
Models: Validator Plus 8 & Plus 10

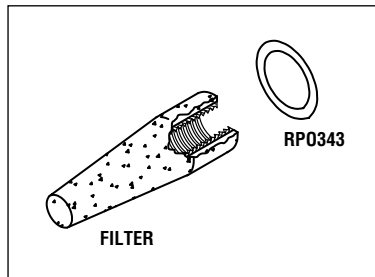

RPI Part #PCF180
OEM Part #1881122

FRONT LEVELING FOOT

- 2 per package
- 1/4-20 x 1" lg. stem

Fits: Bottom front assembly

Models: Validator Plus 8 & Plus 10



RPI Part #PCF179
OEM Part #1539308

RUBBER FOOT ASSEMBLY

- Includes (2) sets of parts as shown
- Fits:** Bottom and rear assembly

Models: Validator Plus 8 & Plus 10

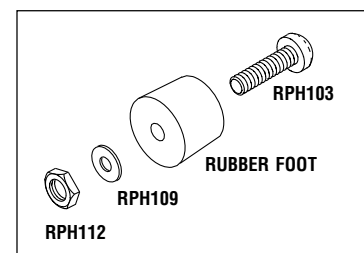

RPI Part #PCT010
New OEM Part #1881023
Old OEM Part #004371

FILL CHAMBER TUBE

Fits: Fill Filter and Chamber

Models: Validator Plus 8 & Plus 10

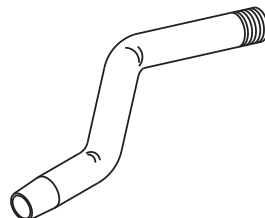

Table Top Sterilizers

Models: Validator Plus 8® (AC) & Plus 10 (AD) (continued)

RPI Part #PCR227
OEM Part #3339913



RESERVOIR (UPGRADE)

- Material: Plastic
- Includes 1/2" Dia. hole for mounting the Water Level Assembly (RPI Part #PCL229)
- Includes Elbow Fitting 3/8" Barb (RPI Part #RPF687) for quick drain

Fits: Mounts to right side of Chamber

Model: Validator Plus 8 & Plus 10

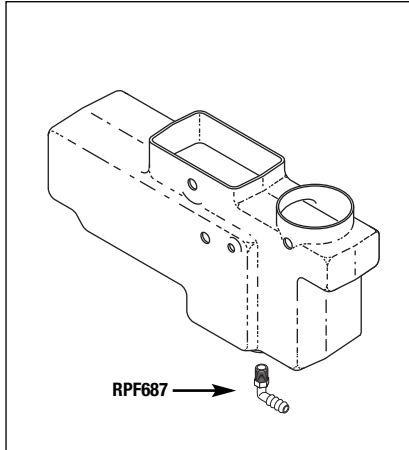

RPI Part #RPF687
OEM Part #1539381



ELBOW FITTING (3/8" BARB)

- 3/8" Barb x 1/4 MPT
- Material: Nylon®
- Included with Reservoir (Upgrade) (RPI Part #PCR227)

Fits: Reservoirs with a 3/8" Drain Line

Model: Validator 8, 10, Plus 8 & Plus 10

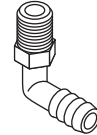

RPI Part #RPK432
OEM Part #3003683

DRAIN TUBE ASSEMBLY KIT (SMALL)

- Fitting: Acetal; Tubing: Clear Polyethylene (.250" OD x .035" Wall)
- Includes all parts as shown

Fits: Front panel

Models: Validator Plus 8 (S/N prior to AC-10000) & Plus 10 (S/N prior to AD-11003)

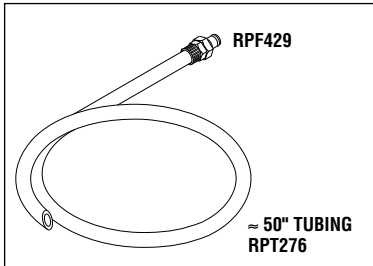

RPI Part #RPF428
OEM Part #1881130

FEMALE QUICK CONNECT FITTING (WHITE)

- Tubing size: .250" OD x .170" ID; Flow: 1/8"; 1.720" lg.
 - Body and valve material: Acetal; Seal material: Buna-N
 - Panel mount ferruleless polytube fitting
 - Operating temperature: -40°F - 180°F
 - Working pressure: Vacuum to 120 PSI
- Fits:** Front Panel/Drain Tube Assembly Kit - Small (RPI Part #RPK432) and Male Quick Connect Fitting (RPI Part #RPF429)

Models: Validator Plus 8 (S/N prior to AC-10000) & Plus 10 (S/N prior to AD-11003)

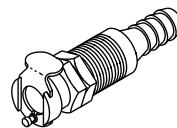

RPI Part #RPF429
OEM Part #1539399

MALE QUICK CONNECT FITTING (WHITE)

- Includes O-Ring (RPI Part #RPO306)
 - Tubing size: .250" OD x .170" ID x 1.150" lg.
 - Body and valve material: Acetal; Seal material: Buna-N
 - Panel mount ferruleless polytube fitting
 - Operating temperature: -40°F - 180°F
 - Working pressure: Vacuum to 120 PSI
- Fits:** Female Quick Connect on Front Panel (RPI Part #RPF428)/Drain Tube Assembly Kit - Small (RPI Part #RPK432)

Models: Validator Plus 8 (S/N prior to AC-10000) & Plus 10 (S/N prior to AD-11003)



RPI Part #RPK431
OEM Part #4193376

DRAIN TUBE ASSEMBLY KIT (LARGE)

- Fitting: Polypropylene; Tubing: Clear PVC (3/8" ID x 5/8" OD)
- Includes all parts as shown

Fits: Front Panel/Female Quick Connect Fitting - Grey (RPI Part #RPF426)

Models: Validator Plus 8 (S/N AC-10000 & above) & Plus 10 (S/N AD-11003 and above)

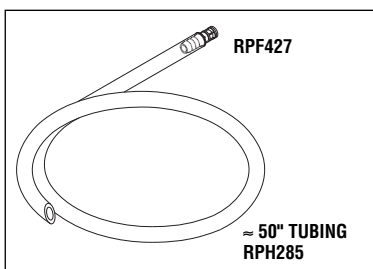

RPI Part #RPF426
OEM Part #1522494

FEMALE QUICK CONNECT FITTING (GREY)

- 3/8" hose barb: 0.28" Flow
 - Body material: Polypropylene; Seals material: EPDM
 - Bulkhead panel mount hose barb body with shut-off
 - Operating temperature: 32°F - 160°F
 - Working pressure: Vacuum to 105 PSI
- Fits:** Front Panel/Drain Tube Assembly Kit - Large (RPI Part #RPK431)
- Models:** Validator Plus 8 (S/N AC-10000 & above) & Plus 10 (S/N AD-11003 and above)

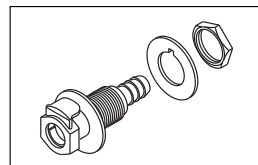

RPI Part #RPF427
OEM Part #1522502

MALE QUICK CONNECT FITTING (GREY)

- Includes fitting, and O-ring (RPI Part #RPO304)
 - 3/8" hose barb: 0.28" Flow
 - Body material: Polypropylene; Seals material: EPDM
 - Hose barb insert;
 - Operating temperature: 32°F - 160°F
 - Working pressure: Vacuum to 105 PSI
- Fits:** Female Quick Connect (RPI Part #RPF426) on Front Panel/Drain Tube Assembly Kit - Large (RPI Part #RPK431)
- Models:** Validator Plus 8 (S/N AC-10000 & above) & Plus 10 (S/N AD-11003 and above)

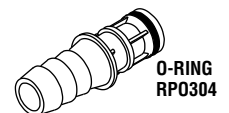

RPI Part #PCT142
New OEM Part #1539357
Old OEM Part #004429

INSTRUMENT TRAY (SMALL)

- Stainless steel
- 6-1/2" x 17" x 1"

Fits: Chamber

Models: Validator Plus 10

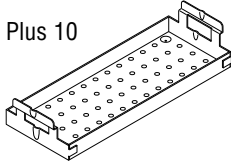

RPI Part #PCT143
New OEM Part #1539340
Old OEM Part #004430

INSTRUMENT TRAY (LARGE)

- Stainless steel
- 8" x 17" x 2-1/2"
- Smaller tray (RPI Part #PCT142) can be stacked on top

Fits: Chamber

Models: Validator Plus 10

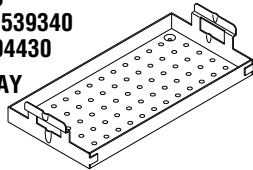

RPI Part #PCC004
OEM Part #004288

POWER CORD WITHOUT CONNECTORS

- 8 ft. lg. with outer jacket stripped 6"
- 15 A @ 120 VAC; 90°C
- Plug: NEMA 5-15; Cord: HSJO 16/3

Fits: Tabletop Sterilizers

Models: Validator 8 (AB) & 10 (AA)

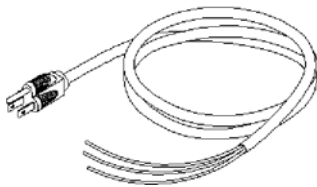

RPI Part #RPI268
OEM Part # (No OEM Part # Available)

CHAMBER INSULATION

- 14-1/4" x 28" x 1/4" thk
- White ceramic fiber paper
- Cut to fit 8" dia. chambers

Fits: Wraps around chamber of autoclave

Models: Validator Plus 8

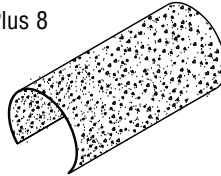

RPI Part #RPI269
OEM Part # (No OEM Part # Available)

CHAMBER INSULATION

- 18-1/4" x 33-3/4" x 1/4" thk
- White ceramic fiber paper
- Cut to fit 10" dia. chambers

Fits: Wraps around chamber of autoclave

Models: Validator Plus 10

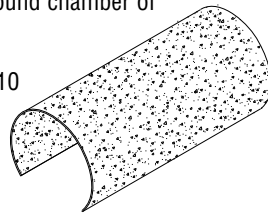

RPI Part #PCS170
OEM Part #1539936

BLACK COVER SCREW

- 12 per package
- #10-24 x 3/8" lg.
- Stainless steel with black zinc plating

Fits: Outer cover

Models: Validator Plus 8 & Plus 10



RPI Part #PCN136
OEM Part #004076

SPEEDNUT

- 10 per package
- "U" type #10-24 thread

Models: Validator Plus 8 & Plus 10



RPI Part #PCB123
New OEM Part #3000119
Old OEM Part #004080

BAND (10")

- Stainless steel
- 1/2" wide
- Holds heaters in place

Fits: 8" chamber

Models: Validator Plus 8

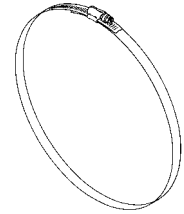

RPI Part #PCB122
New OEM Part #1539647
Old OEM Part #004325

BAND (12")

- Stainless steel
- 1/2" wide
- Holds heaters in place

Fits: 10" chamber

Models: Validator Plus 10

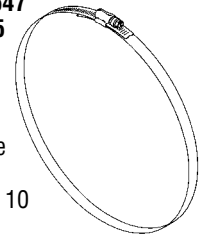

RPI Part #RPT113
OEM Part # (No OEM Part # Available)

MAX REGISTER THERMOMETER

- Mercury
- Length: 5-1/2"
- Accuracy Rating: ±1 Division (±2°F)
- Range: 150°F to 350°F
- Includes thermometer, and metal protective case
- Use for temperature verification in sterilizer

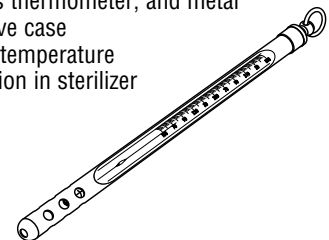

NOTES:

Table Top Sterilizers

Models: KavoClave 2100 Series Old Version I & KavoClave 2100 Series New Version II; Prestige 2100 Series Old Version I, Prestige 2100 Series New Version II & Prestige 2100 Series Classic Version III



**RPI PART #KVG001
OEM PART #219500**

DOOR GASKET

- 9.66" OD
- Models: Versions I, II & III

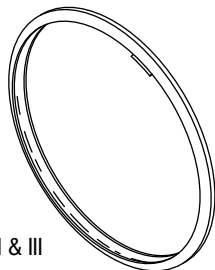

**RPI PART #KVL045
OEM PART #219726**

LID ASSEMBLY

- Aluminum
- Includes: Gasket (RPI Part #KVG001), Air Bleed Kit (RPI Part #KVK002), Pressure Indicator Kit (RPI Part #KVK003), Decal (Warning) (RPI Part #KVD013), Decal (Hot Warning) (RPI Part #KVD014), Depressurization Valve Kit (RPI Part #KVK043), Handle (RPI Part #KVH034), and Handle Moulding (RPI Part #KVH035)
- Models: Newer Lid for Version I & II only

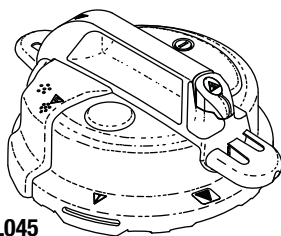

**RPI PART #KVL046
OEM PART #219738**

LID ASSEMBLY

- Stainless steel
- Includes: Gasket (RPI Part #KVG001), Air Bleed Kit (RPI Part #KVK002), Pressure Indicator Kit (RPI Part #KVK003), Decal (Warning) (RPI Part #KVD013), Decal (Hot Warning) (RPI Part #KVD014), Depressurization Valve Kit (RPI Part #KVK043), Handle (RPI Part #KVH034), Handle Moulding (RPI Part #KVH035), and Safety Valve (26 PSI) (RPI Part #KVV037)
- Models: Newer Lid for Version III only

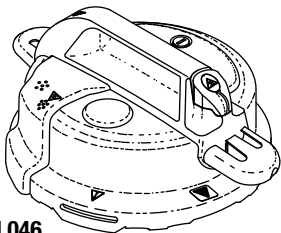

**RPI PART #KVK003
OEM PART #219203**

PRESSURE INDICATOR KIT

- Includes all parts as shown
- Models: Versions I, II & III

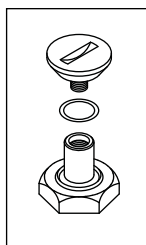

**RPI PART #KVC018
OEM PART #219570**

TOP COVER MouldING

- Fin style handle; Plastic
- Includes all parts as shown including gasket and self sealing hex mounting bolt
- Model: Version II (*Fin style with older Lid*)

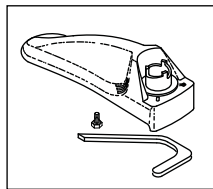

**RPI PART #KVK017
OEM PART #219569**

DEPRESSURIZATION VALVE KIT

- Grey cap
- Includes mounting nut
- Models: Version I & Version II (*Fin style with older Lid*)

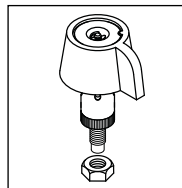

**RPI PART #KVC019
OEM PART #219577**

GASKET OFFSET DEVICE COVER

- Plastic
- Model: Version II (*Fin style with older Lid*)

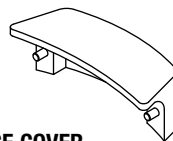

**RPI PART #KVH034
OEM PART #219696**

HANDLE

- Grey plastic
- Includes mounting hardware
- Models: Versions II & III

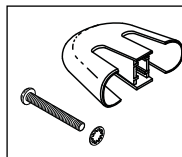

**RPI PART #KVH035
OEM PART #219698**

HANDLE MouldING

- Includes all parts as shown including Valve Cap (RPI Part #KVC044)
- Models: Version II (*with newer Lid*) & Version III

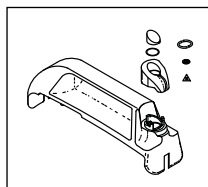

**RPI PART #KVK043
OEM PART #219711**

DEPRESSURIZATION VALVE KIT

- White cap
- Includes all parts as shown including Valve Cap (RPI Part KVC044)
- Models: Version II (*with newer Lid*) & Version III

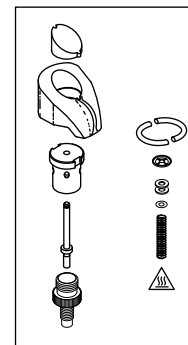

**RPI PART #KVK040
OEM PART #219707**

DEPRESSURIZATION VALVE KIT

- White cap
- Includes all parts as shown including Valve Cap (RPI Part KVC044)
- Models: Version II (*with newer Lid*) & Version III

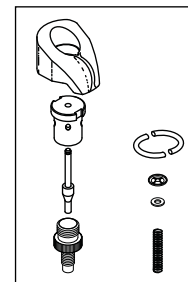

**RPI PART #KVC044
OEM PART #219713**

VALVE CAP

- White cap
- Includes all parts as shown including Decal (Hot Warning) (RPI Part #KVD014)
- Models: Version II (*with newer Lid*) & Version III

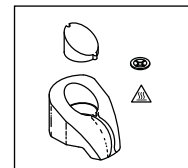

**RPI PART #KVV037
OEM PART #219704**

SAFETY VALVE (26 PSI)

- Brass Body
- Includes panel mounting hardware
- Cracking pressure: 26 PSI
- Models: Version II (*with newer Lid*) & Version III

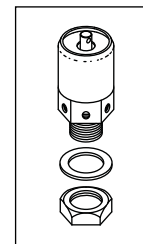

**RPI PART #KVK002
OEM PART #219202**

AIR BLEED KIT

- Includes all parts as shown
- Models: Version II (*with newer Lid*) & Version III

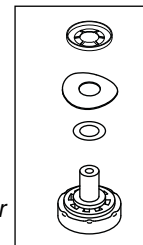
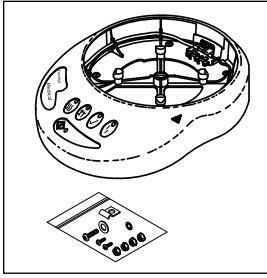

Table Top Sterilizers

Models: KavoClave 2100 Series Old Version I & KavoClave 2100 Series New Version II;
 Prestige 2100 Series Old Version I, Prestige 2100 Series New Version II & Prestige 2100 Series Classic Version III

Version III (110 VAC; 126°C)



RPI PART #KVK063
OEM PART #219552



BASE KIT (110 VAC)

- Single thermofuse wiring
- Includes: Wire Kit (RPI Part #KVK054), AC Inlet Receptacle (RPI Part #RPR710), Pillar Cap (RPI Part #KVC020), and mounting hardware kit

Models: Version III (110 VAC; 126°C)

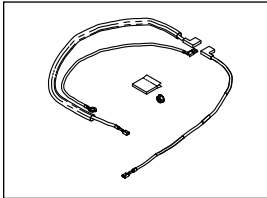

RPI PART #KVK054
OEM PART #219680



WIRE KIT (110 VAC)

- Includes: Single 152° C Thermofuse (RPI Part #KVF029), White Tak and mounting nut

Fits: Base Kit (110 VAC) (RPI Part #KVK063)

Models: Version III (110 VAC; 126°C)

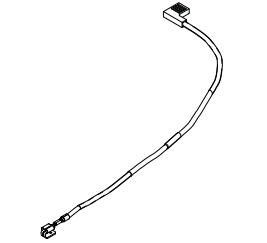

RPI PART #KVF029
OEM PART #219667



THERMAL FUSE (110 VAC)

- Single 152° C Thermofuse
- Fits:** Wire Kit (110 VAC) (RPI Part #KVK054) and Base Kit (110 VAC) (RPI Part #KVK063)

Models: Version III (110 VAC; 126°C)

Version III (230 VAC; 126°C)

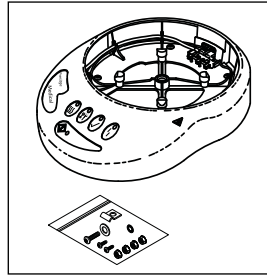

RPI PART #KVK022
OEM PART #219580



BASE KIT (230 VAC)

- Single thermofuse wiring
- Includes: 126°C button decal, Wire Kit (RPI Part #KVK026), AC Inlet Receptacle (RPI Part #KVR004), Pillar Cap (RPI Part #KVC020), and mounting hardware kit

Models: Version III (230 VAC; 126°C)

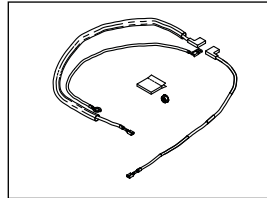

RPI PART #KVK026
OEM PART #219596



WIRE KIT (230 VAC)

- Includes: Single 152° C Thermofuse (RPI Part #KVF055), White Tak and mounting nut

Fits: Base Kit (230 VAC) (RPI Part #KVK022)

Models: Version III (230 VAC; 126°C)

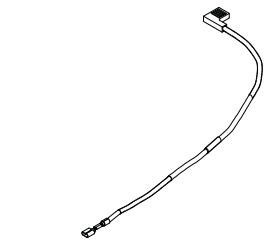

RPI PART #KVF055
OEM PART #219540



THERMAL FUSE (230 VAC)

- Single 152° C Thermofuse
- Fits:** Wire Kit (230 VAC) (RPI Part #KVK026) and Base Kit (230 VAC) (RPI Part #KVK022)

Models: Version III (230 VAC; 126°C)

Version III (230 VAC; 134°C)

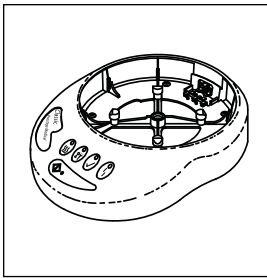

RPI PART #KVK042
OEM PART #219710



BASE KIT (230 VAC)

- Includes: 134°C button decal, AC Inlet Receptacle (RPI Part #RPR710), and Pillar Cap (RPI Part #KVC020)

- All decals are installed

- Does not include Wire Kit

Models: Version III (230 VAC; 134°C)

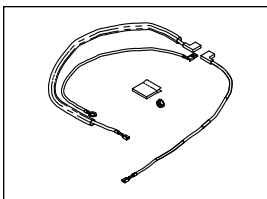

RPI PART #KVK026
OEM PART #219596



WIRE KIT (230 VAC)

- Includes: Single 152° C Thermofuse (RPI Part #KVF055), White Tak and mounting nut

Fits: Base Kit (230 VAC) (RPI Part #KVK042)

Models: Version III (230 VAC; 134°C)

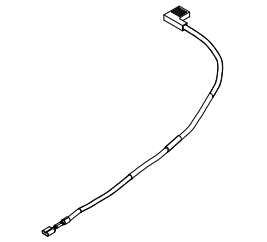

RPI PART #KVF055
OEM PART #219540



THERMAL FUSE (230 VAC)

- Single 152° C Thermofuse
- Fits:** Wire Kit (230 VAC) (RPI Part #KVK026) and Base Kit (230 VAC) (RPI Part #KVK042)

Models: Version III (230 VAC; 134°C)

Version II (FIN MODEL; 110 VAC)

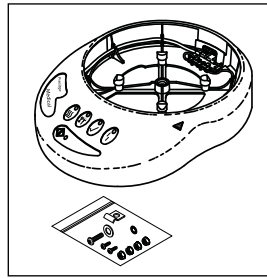

RPI PART #KVK028
OEM PART #219665



BASE KIT (110 VAC)

- Double thermofuse wiring
- Includes: Wire Kit (RPI Part #KVK049), AC Inlet Receptacle (RPI Part #RPR710), Pillar Cap (RPI Part #KVC020), and mounting hardware kit

- Replaces OEM Part #219597

Models: Version II Fin Model (110 VAC)

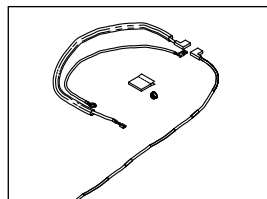

RPI PART #KVK049
OEM PART #219666



WIRE KIT (110 VAC)

- Includes: Double 152° C Thermofuse (RPI Part #KVF058), White Tak and mounting nut

Fits: Base Kit (110 VAC) (RPI Part #KVK028)

Models: Version II Fin Model (110 VAC)



RPI PART #KVF058
OEM PART #219730



THERMAL FUSE (110 VAC)

- Double 152° C Thermofuse
- Fits:** Wire Kit (110 VAC) (RPI Part #KVK049) and Base Kit (110 VAC) (RPI Part #KVK028)

Models: Version II Fin Model (110 VAC)

Version II (FIN MODEL; 230 VAC)

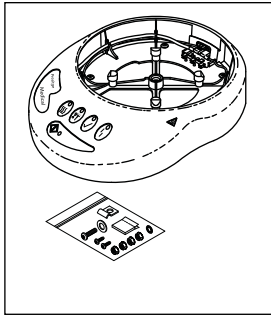

RPI PART #KVK031
OEM PART #219670



BASE KIT (230 VAC)

- Includes: AC Inlet Receptacle (RPI Part #RPR710), Pillar Cap (RPI Part #KVC020), and mounting hardware kit
- Models:** Version II (Fin Model; 230 VAC)

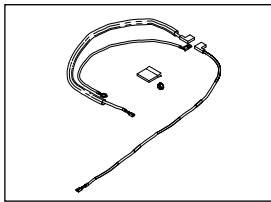

RPI PART #KVK030
OEM PART #219669



WIRE KIT (230 VAC)

- Includes: Double 152° C Thermofuse (RPI Part #KVF056), White Tak and mounting nut

Fits: Base Kit (230 VAC) (RPI Part #KVK031)
Models: Version II (Fin Model; 230 VAC)

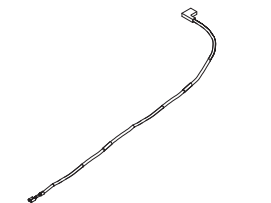

RPI PART #KVF056
OEM PART #219668



THERMAL FUSE (230 VAC)

- Double 152°C Thermofuse
- Fits:** Wire Kit (230 VAC) (RPI Part #KVK030) and Base Kit (230 VAC) (RPI Part #KVK031)

Models: Version II (Fin Model; 230 VAC)

Version I (110 VAC; 121°C)

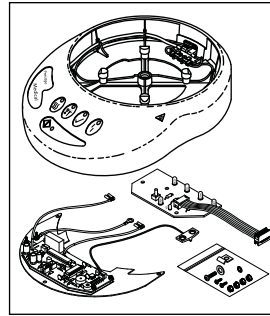

RPI PART #KVK066
OEM PART #219687



BASE KIT (110 VAC)

- Includes: Module Kit (110 VAC) (RPI Part #KVK025, LED/Switch Assembly (RPI Part #KVA024), AC Inlet Receptacle (RPI Part #RPR710), Pillar Cap (RPI Part #KVC020), and mounting hardware kit
- Models:** Version I (110 VAC; 121°C)

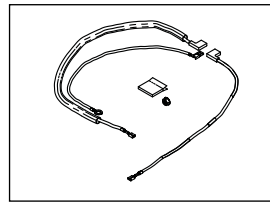

RPI PART #KVK054
OEM PART #219680



WIRE KIT (110 VAC)

- Includes: Single 152° C Thermofuse (RPI Part #KVF029), White Tak and mounting nut

Fits: Base Kit (110 VAC) (RPI Part #KVK066)
Models: Version I (110 VAC; 121°C)

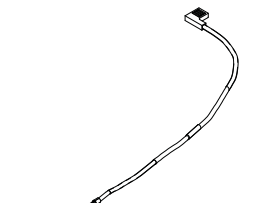

RPI PART #KVF029
OEM PART #219667



THERMAL FUSE (110 VAC)

- Single 152°C Thermofuse
- Fits:** Wire Kit (110 VAC) (RPI Part #KVK054) and Base Kit (110 VAC) (RPI Part #KVK066)

Models: Version I (110 VAC; 121°C)

Version I (230 VAC; 121°C)

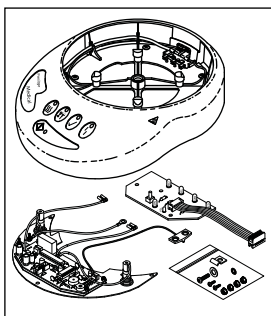

RPI PART #KVK065
OEM PART #219686



BASE KIT (230 VAC)

- Single thermofuse wiring
- Includes: Module Kit (230 VAC) (RPI Part #KVK023, LED/Switch Assembly (RPI Part #KVA024), Wire Kit (RPI Part #KVK026), AC Inlet Receptacle (RPI Part #RPR710), Pillar Cap (RPI Part #KVC020), and mounting hardware kit

Models: Version I (230 VAC; 121°C)

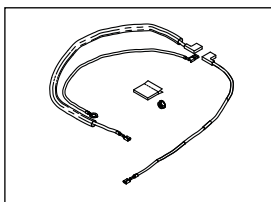

RPI PART #KVK026
OEM PART #219596



WIRE KIT (230 VAC)

- Includes: Single 152° C Thermofuse (RPI Part #KVF055), White Tak and mounting nut

Fits: Base Kit (230 VAC) (RPI Part #KVK065)
Models: Version I (230 VAC; 121°C)

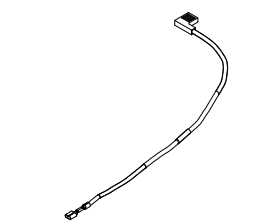

RPI PART #KVF055
OEM PART #219540



THERMAL FUSE (230 VAC)

- Single 152°C Thermofuse
- Fits:** Wire Kit (230 VAC) (RPI Part #KVK026) and Base Kit (230 VAC) (RPI Part #KVK065)

Models: Version I (230 VAC; 121°C)

Version I (230 VAC; 126°C)

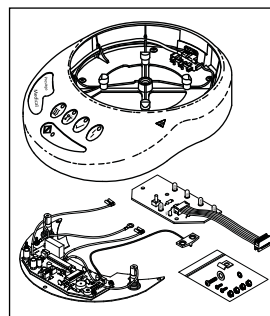

RPI PART #KVK064
OEM PART #219685



BASE KIT (230 VAC)

- Single thermofuse wiring
- Includes: Module Kit (230 VAC) (RPI Part #KVK023, LED/Switch Assembly (RPI Part #KVA024), Wire Kit (RPI Part #KVK026), AC Inlet Receptacle (RPI Part #RPR710), Pillar Cap (RPI Part #KVC020), and mounting hardware kit

Models: Version I (230 VAC; 126°C)

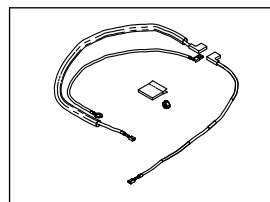

RPI PART #KVK026
OEM PART #219596



WIRE KIT (230 VAC)

- Includes: Single 152° C Thermofuse (RPI Part #KVF055), White Tak and mounting nut

Fits: Base Kit (230 VAC) (RPI Part #KVK064)
Models: Version I (230 VAC; 126°C)

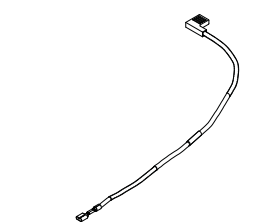

RPI PART #KVF055
OEM PART #219540



THERMAL FUSE (230 VAC)

- Single 152°C Thermofuse
- Fits:** Wire Kit (230 VAC) (RPI Part #KVK026) and Base Kit (230 VAC) (RPI Part #KVK064)

Models: Version I (230 VAC; 126°C)

Table Top Sterilizers

Models: KavoClave 2100 Series Old Version I & KavoClave 2100 Series New Version II;
 Prestige 2100 Series Old Version I, Prestige 2100 Series New Version II & Prestige 2100 Series Classic Version III



RPI PART #KVK025
OEM PART #219590

MODULE KIT (110 VAC)

- Includes mounting hardware
- Use Heat Sink Compound (RPI Part #RPC709) to mount thermistor

Models: Version II (110 VAC) & Version III (110 VAC)

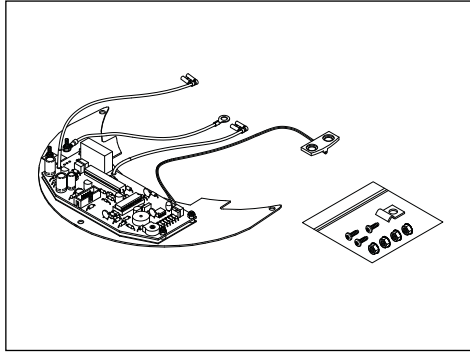

RPI PART #KVK023
OEM PART #219584

MODULE KIT (230 VAC)

- Includes: Fuse holders with Fuse (RPI Part #RPF695), and mounting hardware
- Use Heat Sink Compound (RPI Part #RPC709) to mount thermistor

Models: Version II (Fin Model 230 VAC)

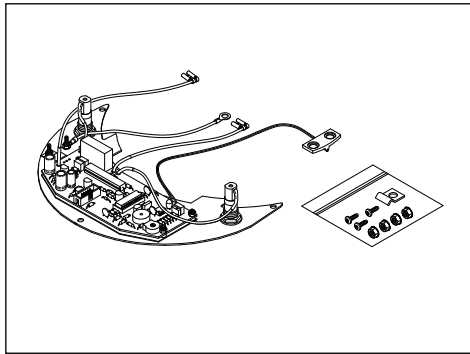

RPI PART #RPC709
OEM PART #219302

HEAT SINK COMPOUND

- Includes: Syringe and Dispensing Tip
- Use to mount thermistor included in Module Kits (RPI Part #'s KVK023 & KVK025)

Models: Versions I, II & III

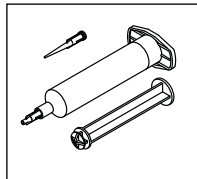

RPI PART #KVK032
OEM PART #219689

WIRE REPAIR KIT

- Includes all parts as shown
- Models:** Version II (Fin Model; 110 VAC), Version II (Fin Model; 230 VAC), Version III (110 VAC) & Version III (230 VAC)

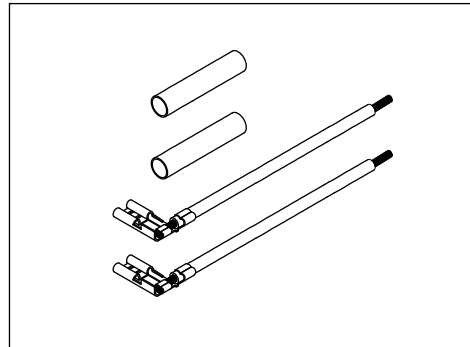

RPI PART #KVA024
OEM PART #219585

LED/SWITCH ASSEMBLY

- 110 VAC
 - Includes: PCB, Interface Cable, and mounting screws
- Models:** Version II Fin Model (110 VAC) & Version III (110 VAC)

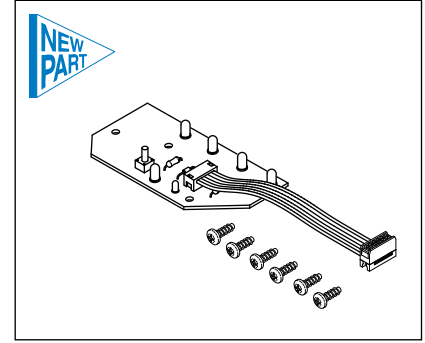

RPI PART #KVC020
OEM PART #219578

PILLAR CAP

- 4 per package
- Vinyl

Models: Version II (Fin Model; 110 VAC), Version II (Fin Model; 230 VAC), Version III (110VAC) & Version III (230 VAC)



RPI PART #KVF021
OEM PART #219579

FRONT FOOT SUPPORT

- Rubber foot - self stick
- Models:** Version II (Fin Model; 110 VAC), Version II (Fin Model; 230 VAC), Version III (110VAC) & Version III (230 VAC)



RPI PART #KVF038
OEM PART #219705

FOOT

- 4 per package
 - White Silicone - push on
- Model:** Version III

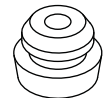

Be sure to visit the RPI website for more new parts to fit all Versions of the Prestige/KavoClave.

Table Top Sterilizers

Models: KavoClave 2100 Series Old Version I & KavoClave 2100 Series New Version II;
Prestige 2100 Series Old Version I, Prestige 2100 Series New Version II & Prestige 2100 Series Classic Version III



RPI PART #KVK047
OEM PART #219728

CASSETTE RACK KIT

- Includes: Instrument Basket (Large) (RPI Part #KVB041), Lifter Fork (RPI Part #KVF009), and (3) each Cassette (RPI Part #KVC006)

Models: Versions II & III

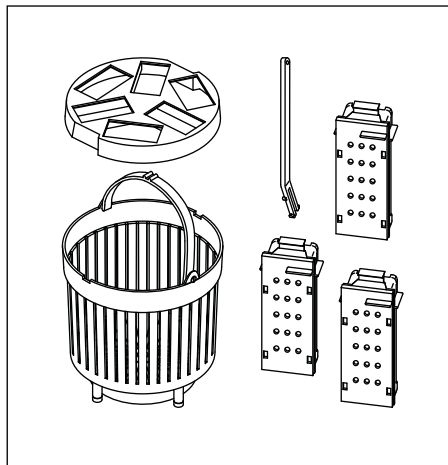

RPI PART #KVS010
OEM PART #219295

V-SUPPORT

- .12" dia. stainless steel wire

Models: Versions I, II & III

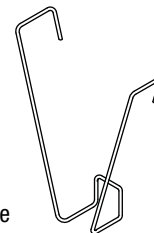

RPI PART #KVF009
OEM PART #219294

LIFTER FORK

- Plastic

Models: Versions II & III

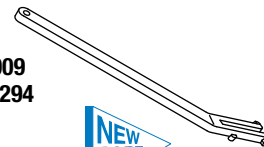

RPI PART #KVB041
OEM PART #219708

INSTRUMENT BASKET (LARGE)

- Plastic
- ~8.25" dia. x 7.63" height

Models: Versions II & III

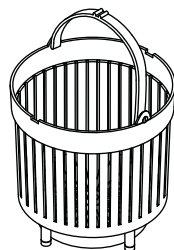

RPI PART #KVK039
OEM PART #219706

CASSETTE HOLDER KIT

- Includes: Cassette Holder (RPI Part #KVH051) and (3) Cassettes (RPI Part #KVC006)

Fits: Instrument Basket (Large)

(RPI Part #KVB041) only

Models: Versions II & III

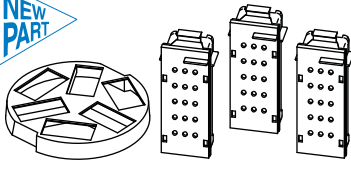

RPI PART #KVK015
OEM PART #219550

BODY KIT (230 VAC)

- Chamber Only
- Includes mounting hardware
- Integral heater element

Model: Version II only

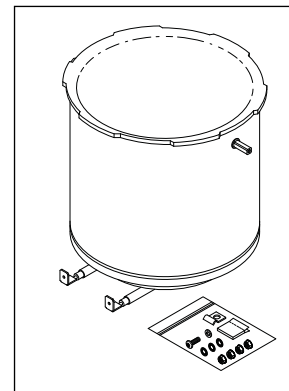

RPI PART #KVB007
OEM PART #219292

INSTRUMENT BASKET (SMALL)

- Plastic
- ~8.25" dia. x 6.50" height

Models: Versions II & III

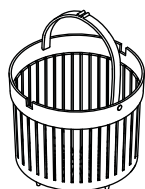

RPI PART #KVC006
OEM PART #219291

CASSETTE

- Plastic

Models: Versions II & III

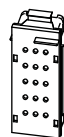

RPI PART #KVH051
OEM PART #219740

CASSETTE HOLDER

- Plastic

Models: Versions II & III

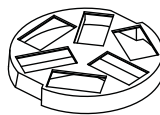

RPI PART #KVT008
OEM PART #219293

INSTRUMENT TRAY

- Plastic

Models: Versions II & III

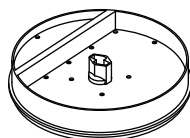

RPI PART #KVS050
OEM PART #259277

STERILE STRIP

Models: Versions I, II & III

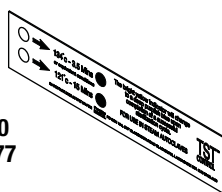

RPI PART #KVK016
OEM PART #219552

BODY KIT (110 VAC)

- Chamber Only
- Includes mounting hardware
- Integral heater element

Models: Versions II & III

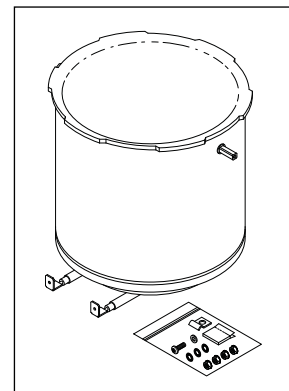
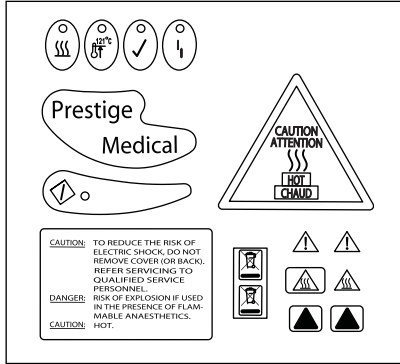

Table Top Sterilizers

Models: KavoClave 2100 Series Old Version I & KavoClave 2100 Series New Version II;
 Prestige 2100 Series Old Version I, Prestige 2100 Series New Version II & Prestige 2100 Series Classic Version III



RPI PART #KVD036
 OEM PART #219701



DECAL KIT

- Includes all parts as shown including Decal (Warning) (RPI Part #KVD013), Decal (Hot Warning) (RPI Part #KVD014), and the 121°C button decal

Models: Versions II & III



RPI PART #KVD013
 OEM PART #219535



DECAL (WARNING)

Models: Versions II & III

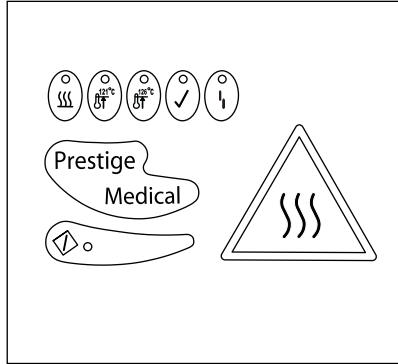

RPI PART #KVD033
 OEM PART #219691 & 219600



DECAL KIT

- Includes all parts as shown including both the 121°C and 126°C button decals

Models: Versions II & III



RPI PART #KVD014
 OEM PART #219536



DECAL (HOT WARNING)

Models: Versions II & III

TEST EQUIPMENT/TOOLS & ACCESSORIES



RPI PART #KVT052
 OEM PART #T-125-304-S

THERMOCOUPLE

Fits: Thermo Port (RPI Part #KVP048)

Models: Versions II & III
 (with newer Lid)

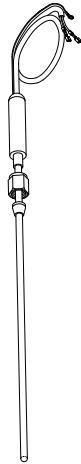

RPI PART #KVS050
 OEM PART #259277

STERILE STRIP

Models: Versions I, II & III

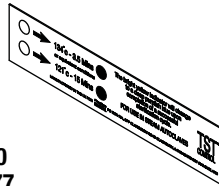

RPI PART #KVP048
 OEM PART #219722

THERMO PORT

- Feed-thru port for sterilizer calibration

Fits: Thermocouple (RPI Part #KVT052)

Models: Versions II & III (with newer Lid)

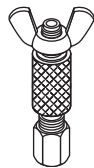

RPI PART #RPC709
 OEM PART #219302

HEAT SINK COMPOUND

- Includes: Syringe and Dispensing Tip
- Use to mount thermistor included in Module Kits (RPI Part #'s KVK023 & KVK025)

Models: Versions I, II & III

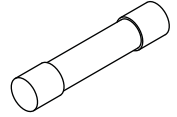
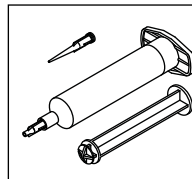

RPI PART #RPF695
 OEM PART #219281

FUSE (10A)

- Ceramic "Fast Acting"
- 10A @ 125VAC
- .25" dia. x 1.25"

Fits: Fuse holders in Module Kit (230 VAC)
 (RPI Part #KVK023)

Model: Version III

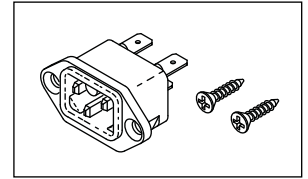

RPI PART #RPR710
 OEM PART #219235

AC INLET RECEPTACLE

- 15A @ 125VAC
- .25" Quick Connct Tabs
- Keyed Mating feature
- Includes: 2 ea. Mounting Screws and "Ground" decal

Models: Versions I, II & III

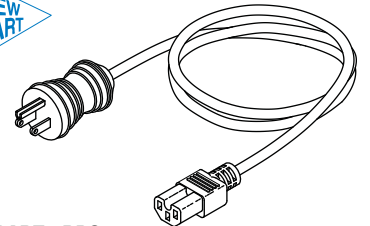

RPI PART #RPC708
 OEM PART #219299

POWER CORD

- Hospital Grade
- Length: 6 ft.
- 16/3 SJT, 105° C
- 13A @ 125VAC
- Plug Type: Nema 5-15P
- Connector Type: IEC 60320-C15
- Color: White; Keyed mating feature

Models: Versions I, II & III

Be sure to visit the RPI website for more new parts to fit all Versions of the Prestige/KavoClave.

RPI Part #PCG016
OEM Part # (No OEM Part # Available)

DOOR GASKET
 • 9.250" OD x .250"
 Sq. C/S
Fits: Door
Model: 666X

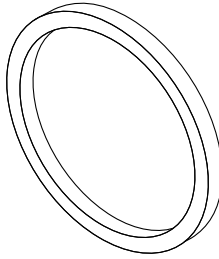

PCG016
 CROSS SECTION
 SHOWN ACTUAL SIZE

RPI Part #RCG017
OEM Part #3036

DOOR GASKET
 • 7.000" OD x .187"
 dia. C/S
Fits: Chamber
Model: 777

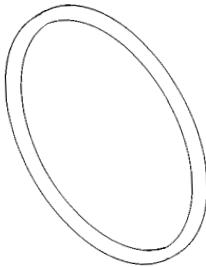

RCG017
 CROSS SECTION
 SHOWN ACTUAL SIZE

RPI Part #RCG018
OEM Part #11540

DOOR GASKET
 • 9.750" OD x .375"
 Sq. C/S
Fits: Door
Models: 999 Series

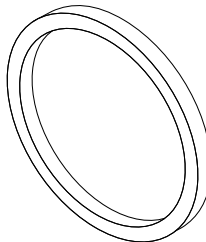

RCG018
 CROSS SECTION
 SHOWN ACTUAL SIZE

RPI Part #RCN013
OEM Part #3047

HINGE SCREW NUT
 • 5 per package
 • Stainless steel; Thread #10-32
Fits: Hinge screw
Model: 777



RPI Part #RCB001
OEM Part #10017

BELLOWS ASSEMBLY
 • Includes all parts as shown
 • Mounts in back of chamber liner
Model: 777

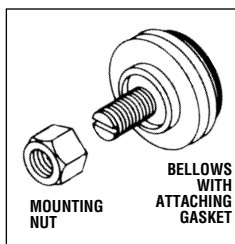

RPI Part #RCG046
OEM Part #11610

SIGHT GLASS
 • .480" OD x 8.750" lg.
Fits: Front Panel
Models: 999 Series

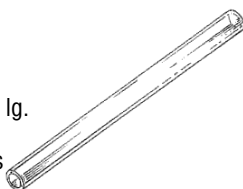

RPI Part #RCW009
OEM Part #3059

DOOR WASHER
 • Material: Plated Brass
Fits: Door Assembly (T-Bolt)
Model: 777



RPI Part #RCC010
OEM Part #3063

CAM
Fits: Door Handle
Model: 777

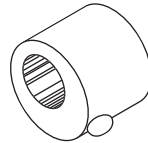

RPI Part #RCB088
OEM Part #H96772

T-BOLT
 • 5/16-24
Fits: Door assembly
Model: 777

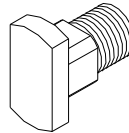

RPI Part #RCP011
OEM Part #34501

CAM PIN
 • Includes cam pin and retaining ring
Fits: Cam Assembly
Model: 777

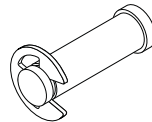

RPI Part #RCS012
OEM Part #3046

HINGE SCREW
 • Thread #10-32 x 2 1/8" lg.
Fits: Door Hinge
Model: 777

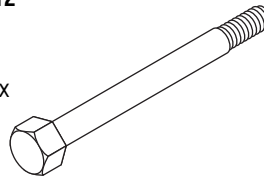

RPI Part #RCB003
OEM Part #33079

THERMAL DIAPHRAGM BELLOWS ASSEMBLY
 • Includes bellows, fiber washer, internal tooth washer, and special hex nut
 • Mounts inside chamber under relay assembly
Model: 777

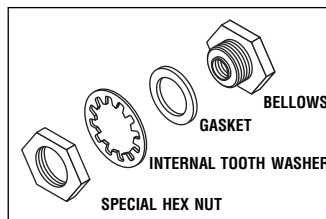

RPI Part #RPF300
OEM Part #3023

SUCTION CUP FOOT
 • 4 per package
 • #8-32 x 1/4" lg. stud
Fits: Bottom of machine
Model: 777

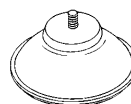

RPI Part #RCK029
OEM Part # (No OEM Part # Available)

PRESSURE GAUGE MOUNTING KIT
 • Includes all parts as shown
Fits: Pressure Gauge Assembly
Model: 777

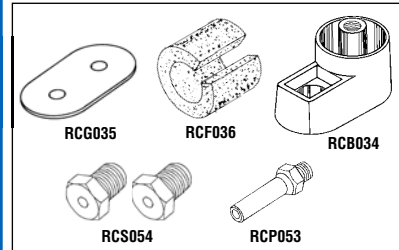

RPI Part #RCB034
OEM Part #3025

PRESSURE GAUGE MOUNTING BASE
Fits: Gauge Assembly
Model: 777

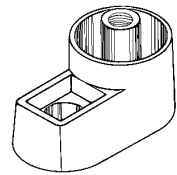

RPI Part #RCG035
OEM Part #3026

GASKET
Fits: Pressure Gauge Mounting Base
Model: 777

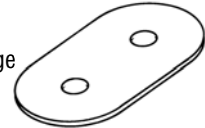

RPI Part #RCF036
OEM Part #3091

COTTON FILLING
Fits: Gauge Mounting Base
Model: 777

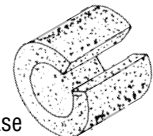

RPI Part #RCP053
OEM Part #3282

VENT PIPE ASSEMBLY
Fits: Pressure Gauge Assembly
Model: 777

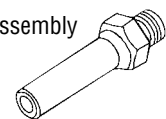

RPI Part #RCS054
OEM Part #3095

MOUNTING BASE VENT SCREW
 • Stainless steel
 • 5/16-24 x 1/2" lg.
Fits: Mounting Base Assembly
Model: 777

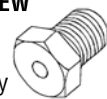

RPI Part #PCN136
OEM Part # (No OEM Part # Available)

SPEEDNUT
 • #10 per package
 • "U" type 10-24 thread

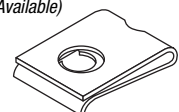

Table Top Sterilizers

Models: F, 666X, 777 & 999 Series (continued)

RPI Part #RCH118
OEM Part # (No OEM Part # Available)

HEATING ELEMENT ASSEMBLY

- 1136W, 118VAC, ~12Ω
 - Includes all parts as shown
 - Replaces old RPI Part #RCH024
 - Mounts inside chamber
- Model: 777**

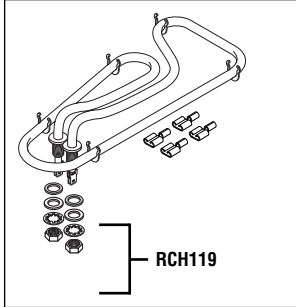

RPI Part #RCH119
OEM Part # (No OEM Part # Available)

ATTACHING HARDWARE

- Includes all parts as shown
 - Fits:** Heating Element Assembly (RPI Part #RCH118) only
- Model: 777**

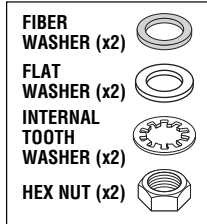

RPI Part #RP0356
OEM Part #11611
Industry Part #2-111

O-RING

- 12 per package
 - Material: Buna-N (Nitrile)
 - Hardness: 70
 - .630" OD x .424" ID x .103" C/S
 - Fits:** Fill Tube
- Models: 999 Series**

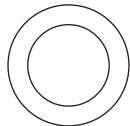

RPI Part #RP0304
OEM Part #11559
Industry Part #2-011

O-RING

- 12 per package
 - Material: Buna-N (Nitrile)
 - Hardness: 70
 - .441" OD x .301" ID x .070" C/S
 - Fits:** Globe Valve
- Models: 999 Series**



RPI Part #RCF015
OEM Part #14813

PLASTIC FOOT

- 4 per package
 - Fits:** Bottom of machine
- Models: 999 Series**

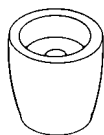

RPI Part #RCS042
OEM Part #33053 & H98100

RELAY SWITCH ASSEMBLY

- Includes relay switch and crimp-on terminal
 - Fits:** Relay Control Bracket
- Model: 777**

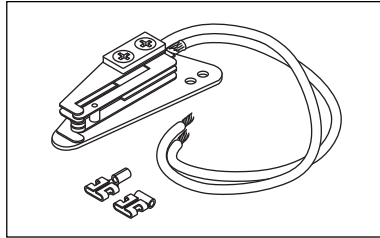

RPI Part #PCC004
OEM Part #33071

POWER CORD WITHOUT CONNECTORS

- 8 ft.
- 16/3 HSJO, 90°C; 15A@125VAC
- Fits:** Tabletop Sterilizers

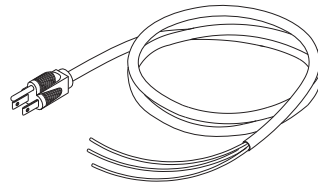

RPI Part #RCB002
OEM Part #144382

BELLOWS ASSEMBLY

- Includes bellows, and compression fitting
 - Mounts in reservoir
- Models:** F & 999 Series

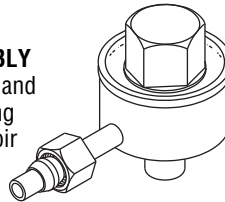

RPI Part #RCG020
OEM Part #11567

VALVE GASKET

- Copper fiber
 - Fits:** Globe Valve
- Models: 999 Series**

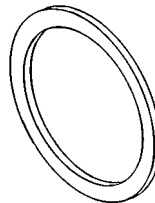

RPI Part #RCD008
OEM Part #11563

GLOBE VALVE DISK

- 6 per package
 - Material: Buna-N (Nitrile)
 - Hardness: 80 Duro
 - .660" OD x .250" ID x .187" thk
 - Fits:** Globe Valve
- Models: 999 Series**

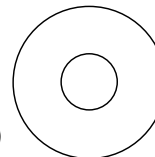

RPI Part #RCW056
OEM Part #14549

FILTER WASHER

- Models: 999 Series**



RPI Part #RCT047
OEM Part #34551

TIME SWITCH

- 1hp @ 120VAC-240VAC
 - 60 minute mechanical time switch; SPST
 - Switch: 20A @ 240VAC; Bushing mount
 - Includes timer, dial face, knob, mounting nut, and (2) terminal screw
- Model: 777**

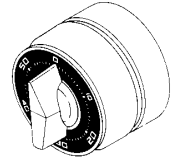

RPI Part #RCT048
OEM Part #11521

TIME SWITCH

- 1hp @ 125VAC, 2hp @ 250VAC
- 60 minute mechanical time switch
- SPST, Switch: 20A @ 250VAC
- Replaces electric timer

Includes all parts as shown
Model: 999 Series

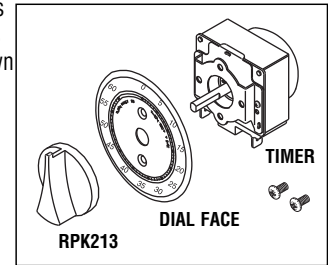

RPI Part #RPK213
OEM Part # (No OEM Part # Available)

KNOB

- Fits:** Time Switch (RPI Part #RCT048) only
- Model: 999 Series**



RPI Part #RCK092
OEM Part #H98062

TIMER KNOB

- Fits 3/16" dia. shaft
 - Dial: 0-30 minutes
 - Shaft hole is a spring clip
 - Black plastic; aluminum skirt and inlay
 - Fits:** Timer shaft
- Models: 777**

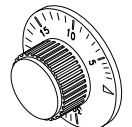

RPI Part #RPT113
OEM Part # (No OEM Part # Available)

MAX REGISTER THERMOMETER

- Mercury; Length: 5-1/2"
- Accuracy Rating: ±2 Div.
- Range: 150°F to 350°F
- Includes thermometer, and metal protective case



RPI Part #RCV051
OEM Part #11683

PRESSURE RELIEF SAFETY VALVE

- 1/8" MPT
 - Cracking Pressure: 31 PSI
- Model: 999 Series**



PM SERVICE TIP

Lube Cassette Seals (RPI Part #SCS001 and SCS029) with (1) pouch of Liquid Soap (RPI Part #RPS287) every 30 days. The OEM recommends replacing the Cassette Seals every 6 months or every 500 cycles (whichever comes first).

RPI Part #SCS001
OEM Part #01-100028S

CASSETTE SEAL

- Black silicone
- Includes Liquid Soap (RPI Part #RPS287)
- ~7-3/4" x 11-3/4"

Fits: Cassette lid
Model: 2000

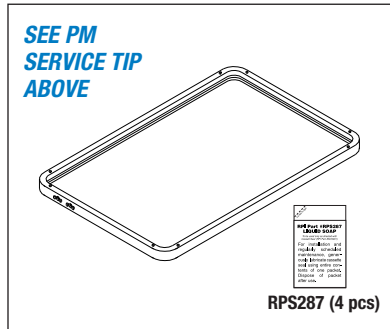

RPI Part #SCS029
OEM Part #01-101649S

CASSETTE SEAL

- Black silicone
- Includes Liquid Soap (RPI Part #RPS287)
- ~7-3/4" x 15-3/4"

Fits: Cassette lid
Model: 5000

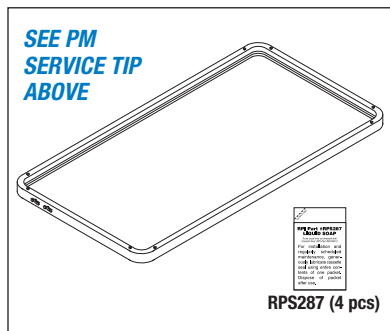

RPI Part #RPS287
OEM Part # (No OEM Part # Available)

LIQUID SOAP

- 4 per package - 1/8 oz. foil pouches

For Use: Use when maintaining or replacing Cassette Seal (RPI Part #SCS001 & SCS029)



RPI Part #SCK035
OEM Part #01-100028S
(Gasket Only)

STERILIZER PM KIT

- Includes all parts as shown
- Model:** 2000

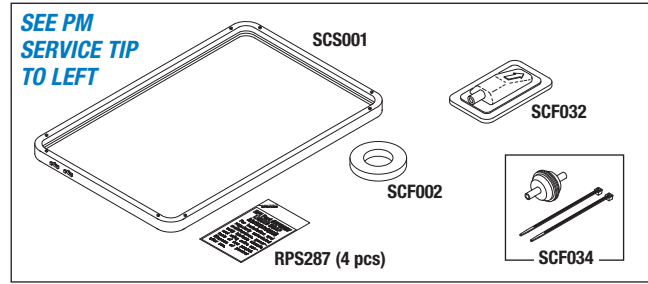

RPI Part #SCK036
OEM Part #01-101649S
(Gasket Only)

STERILIZER PM KIT

- Includes all parts as shown
- Model:** 5000

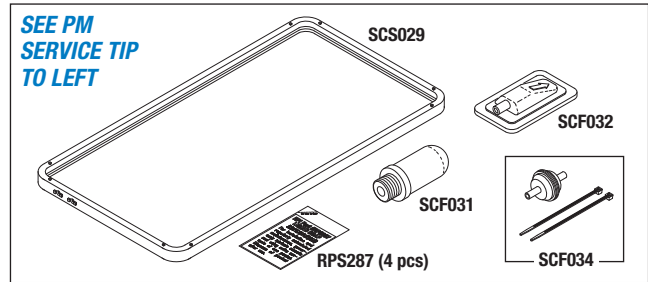

RPI Part #SCA046
OEM Part #80ZPLUS (Stat-Dri Plus™)/
320ZPLUS (Stat-Dri Plus™)

SCI-DRY™ (16 oz. REFILL)

- Drying and rinse agent
 - (1) 16 oz. bottle
- Models:** 2000, 5000 & 7000 series cassette sterilizers; and Hydrim® series washers



- Also available by the case of 12 bottles!
Just ask for SCI-DRY™ (16 oz. REFILL - CASE) (RPI Part #SCA047)

RPI Part #SCA054
OEM Part #20ZPLUS (Stat-Dri Plus™)/
80ZPLUST (Stat-Dri Plus™)

SCI-DRY™ (2 oz.)

- Drying and rinse agent
 - (1) 2 oz. spray bottle
- Models:** 2000, 5000 & 7000 series cassette sterilizers



- Also available by the case of 12 bottles!
Just ask for SCI-DRY™ (2 oz. - CASE) (RPI Part #SCA055)

RPI Part #RPK791
OEM Part # (No OEM Part # Available)



CLEANING KIT

- Supplied in a convenient sturdy canvas Carrying Case (RPI Part #RPC799)
- Side pockets on Carrying Case expand to accommodate 16 oz. refill bottles
- Includes all parts as shown
- All items also sold separately

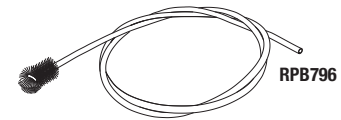
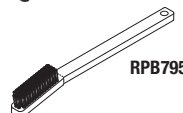
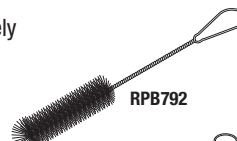
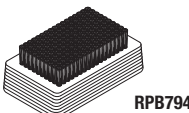
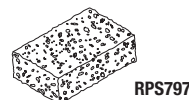
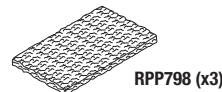

Table Top Sterilizers

Models: STATIM® 900, 2000 & 5000 Series (continued)

RPI Part #SCK028 Field Service Smart Kit® For Servicing SciCan® Cassette Autoclaves 2000 & 5000



This exclusive service and repair Kit is only offered by RPI.

It includes RPI "one-of-a-kind" tools like the easy to use Probe Bracket Alignment Tool, a 25" long Extension Test Cable, Start Switch, Pump Tester Bottle with an extended swivel elbow for easy positioning, and many other tools including a Water Quality Tester with the Calibration Solution. Plus, this Kit includes RPI's *A Guide to Maintaining the SciCan STATIM Cassette Autoclave*, an essential booklet offering troubleshooting and service tips, error code descriptions, detailed exploded views and more!

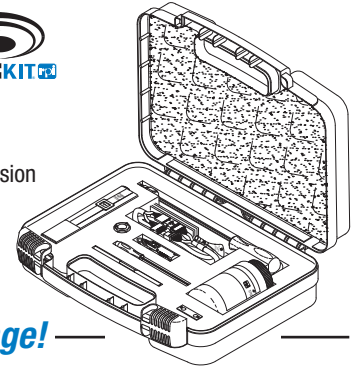

Kit includes all parts shown on this page!

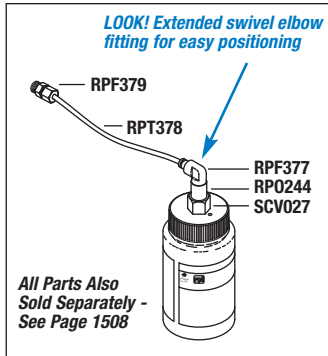

Convenient and easy way to test the pump

PUMP TESTER BOTTLE KIT

RPI Part #SCK024

OEM Part #01-100713S

- Use to test pump
- All parts also sold separately - See page 1508 for details

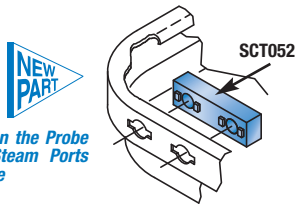

Easily align the Probe Bracket Steam Ports to Cassette

ALIGNMENT TOOL

RPI Part #SCT052

OEM Part #01-106776S (Probe Alignment Jig)

- Size: 1.50" x .31" x .25"

Fits: Cassette to Probe Bracket

Convenient, sturdy, lockable carrying case with Pick 'n Pluck foam to customize your needs



CARRYING CASE

RPI Part #RPC476

- 14" L x 10-1/2" W x 3-3/8" D



Easily access Probe Bracket Mounting Screws without removing other components

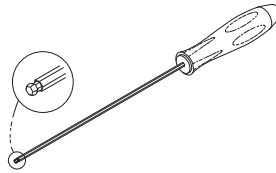

HEX BALLDRIVER (9/64")

RPI Part #RPT836

- 9/64" Ball-Point Hex Driver
- Use with the OEM or RPI Probe Brackets (RPI Part #'s SCB039 & SCB042) and Probe Bracket Kits (RPI Part #'s SCK038 & SCK043)

Allows replacement of Microswitch without removal of any components

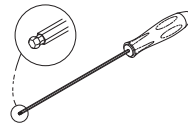

HEX BALLDRIVER (5/64")

RPI Part #RPT297

- 5/64" Ball-Point Hex Driver
- Use with RPI Microswitch Kit (RPI Part #SCK007)

Easily assess water quality



WATER QUALITY TESTER

RPI Part #RPT820

OEM Part #01-103139S

- Size: 5.9" x 1.2" x 0.8"
- Also available: Calibration Solution (RPI Part #RPS821)

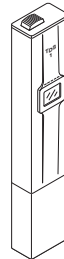

Simply insert Water Quality Tester into packet



RPI Part #RPS821

OEM Part # (No OEM Part # Available)

CALIBRATION SOLUTION

- 4 pouches per package (20ml pouches)
- Use to verify calibration of Water Quality Tester (RPI Part #RPT820)

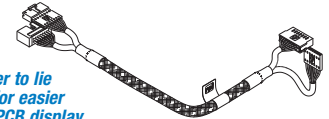
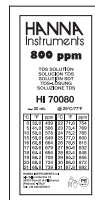

Allows cover to lie horizontal for easier reading of PCB display

EXTENSION TEST CABLE (25" lg.)

RPI Part #SCT026

- Teflon® wire with flame retardant braided sleeving
- Fits: Display/Keypad to PCB

The safe and easy way to "jump start" the pump during testing

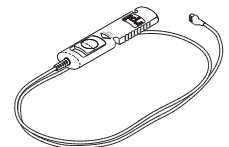

START SWITCH

RPI Part #SCS021

- Use to "jump start" the Pump, Solenoid Valve and Air Compressor
- Fits: P1 connector on the Main PC board

Easily remove the Cassette seal without damage

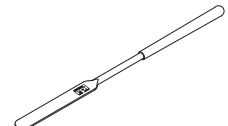

CASSETTE SEAL REMOVAL TOOL

RPI Part #RPT372

- 19/64" wide spatula; 5-5/16" long
- Stainless steel with a vinyl covered handle and plastic sheath

Convenient one-time-use pouches

LIQUID SOAP (4/PKG)

RPI Part #RPS287



Easily seals valve fittings

THREADLOCKER 545

RPI Part #RPA369

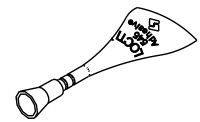

Safely remove and install solenoid valve stems

SPANNER NUT

(RPI Part #RPT364)

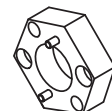

RPI Part #SCP050

OEM Part #01-100568S (Invensys Pump - STATIM 2000)/**01-101761S** (Invensys Pump - STATIM 5000)

PUMP KIT

- 120 Volts, 60Hz.
- This Invensys brand pump will accommodate STATIM® 2000 and 5000 with autoclave software R603 and older only
- Includes all parts as shown
- Also available: Drain Kit With Pump Filter (RPI Part #SCK037) and RPI Field Service Smart Kit® (RPI Part #SCK028)

Fits: Chassis

Models: 2000 & 5000

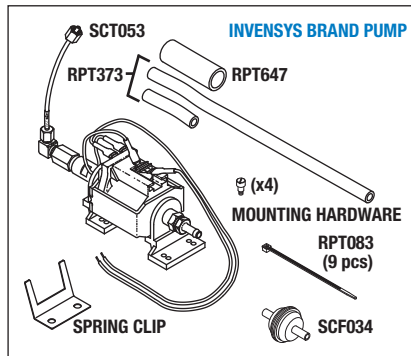

RPI Part #SCP051

OEM Part #01-110445S (Ulka Pump - STATIM 2000)/ **01-110446S** (Ulka Pump - STATIM 5000)

PUMP KIT

- 120 Volts, 60Hz.
- This Ulka brand pump will accommodate STATIM 2000 and 5000 with autoclave software R604 and above only
- Includes all parts as shown
- Also available: Drain Kit With Pump Filter (RPI Part #SCK037) and RPI Field Service Smart Kit® (RPI Part #SCK028)

Fits: Chassis

Models: 2000, 5000, G4 2000 & G4 5000

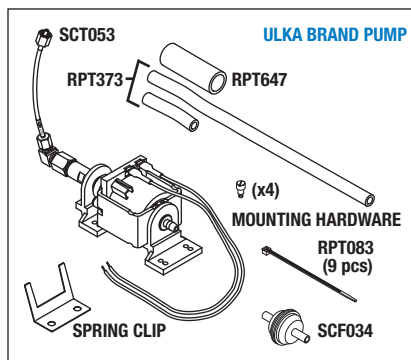

RPI Part #SCT053

OEM Part #01-108816S

METERING TUBE (290)

- Use as replacement pump tube or as pump recovery tube
- Size: 1/8" OD tubing x 5-1/2" lg.
- Included in: Pump Kit (RPI Part #'s SCP050 & SCP051)

Fits: Pump to Boiler

Models: 2000, 5000, G4 2000 & G4 5000

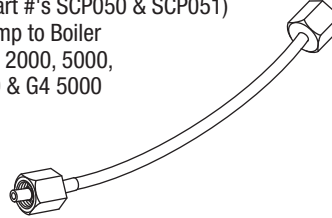

RPI Part #SCF034

OEM Part #01-106637S

WATER FILTER (IN-LINE)

- 3/16" ID hose connectors; 1-1/4" dia. body; overall length: 2"
- Plastic body, copper wire mesh element
- Includes all parts as shown
- **PM SERVICE TIP:** The OEM recommends replacing the filter every 6 months or every 500 cycles (whichever comes first)
- Included in: Sterilizer PM Kit (RPI Part #'s SCK035 & SCK036) and Drain Kit With Pump Filter (RPI Part #SCK037)

Fits: Pump Tubing

Models: 900, 2000, 5000, G4 2000 & G4 5000

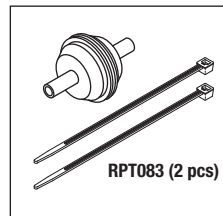

RPI Part #RPT373

OEM Part # (No OEM Part # Available)

TUBING (3/16" ID x 5/16" OD NATURAL)

- Sold by the foot (reel NOT included)
- Material: 50 DURO natural translucent silicone
- Temperature rating: Up to 500°F
- Included in: Drain Kit With Pump Filter (RPI Part #SCK037), Check Valve Kit (RPI Part #SCK011) & Pump Kits (RPI Part #'s SCP050 & SCP051)

Models: 2000, 5000, G4 2000 & G4 5000

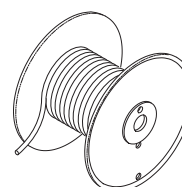

RPI Part #SCK059

OEM Part #01-101783S/01-109300S (Filter only)

RESERVOIR CAP & FILTER

- Includes all parts as shown
- All parts also sold separately
- Fits:** Reservoir Assembly and Top Cover
- Models:** 2000 & 5000

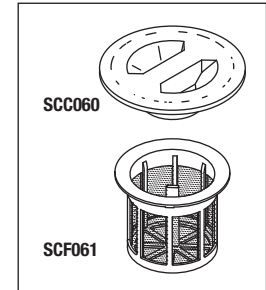

RPI Part #SCC060

OEM Part #01-101783S (Reservoir Cap & Filter)

RESERVOIR CAP

- Included in: Reservoir Cap & Filter (RPI Part #SCK059)

Fits: Top Cover

Models: 2000 & 5000



RPI Part #SCF061

OEM Part #01-109300S

FILTER

- Included in: Reservoir Cap & Filter (RPI Part #SCK059)

Fits: Reservoir Assembly

Models: 2000, 5000, G4 2000 & G4 5000

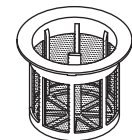

RPI Part #SCF006

OEM Part #01-104461S/10-106462S

DOUBLE THERMAL FUSE ASSEMBLY

- Temperature rating: Opens @ 216°C
- Can be used on single fused steam generator/boilers
- Includes all parts as shown

Fits: Steam Generator/Boiler

Models: 900, 2000, 5000, G4 2000 & G4 5000

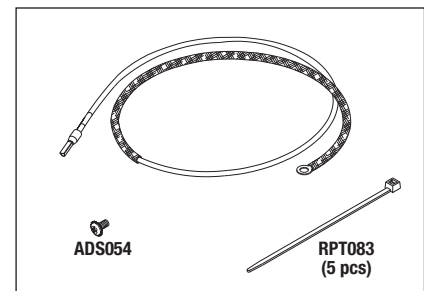

Table Top Sterilizers

Models: STATIM® 900, 2000, 5000, G4 2000 & G4 5000 Series (continued)

RPI Part #SCK038
OEM Part #01-100570S

PROBE BRACKET KIT

- Includes: (2 pcs) Compression Sleeve (RPI Part #RPF215), (2 pcs) Compression Nut (RPI Part #RPF219), (2 pcs) Copper Tubing, Probe Bracket (RPI Part #SCB039), Microswitch Kit (RPI Part #SCK007), Thermocouple (RPI Part #SCT030) and mounting hardware • Also see the **LOOK!** box below featuring the Alignment Tool (RPI Part #SCT052) and Hex Balldriver (9/64") (RPI Part #RPT836)

Fits: Cassette Bay (Armature) • **Models:** 2000 & G4 2000

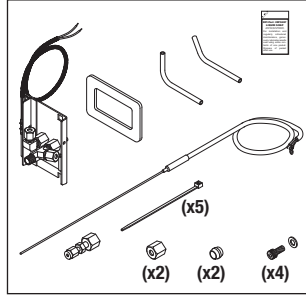

RPI Part #SCK042
OEM Part #01-101618S

PROBE BRACKET KIT

- Includes: (2 pcs) Compression Sleeve (RPI Part #RPF215), (2 pcs) Compression Nut (RPI Part #RPF219), (2 pcs) Copper Tubing, Probe Bracket (RPI Part #SCB043), Microswitch Kit (RPI Part #SCK007) Thermocouple (RPI Part #SCT030) and mounting hardware • Also see the **LOOK!** box below featuring the Alignment Tool (RPI Part #SCT052) and Hex Balldriver (9/64") (RPI Part #RPT836)

Fits: Cassette Bay (Armature) • **Models:** 5000 & G4 5000

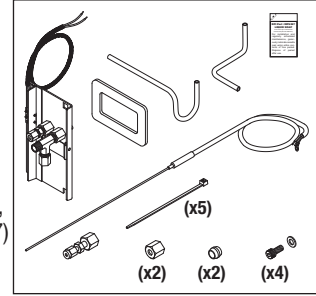

RPI Part #SCB039
OEM Part #01-100570S (Complete Assy)

PROBE BRACKET

- Probe Bracket allows replacement of damaged steam ports or spring bar without replacing the thermocouple and microswitch
- Includes all parts as shown
- Also see the **LOOK!** box below featuring the Alignment Tool (RPI Part #SCT052) and Hex Balldriver (9/64") (RPI Part #RPT836)

Fits: Cassette Bay (Armature) • **Models:** 2000 & G4 2000

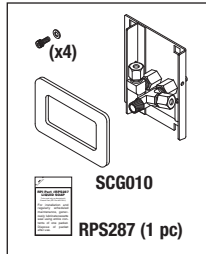

RPI Part #SCB043
OEM Part #01-101618S (Complete Assy)

PROBE BRACKET

- Probe Bracket allows replacement of damaged steam ports or spring bar without replacing the thermocouple and microswitch
- Includes all parts as shown
- Also see the **LOOK!** box below featuring the Alignment Tool (RPI Part #SCT052) and Hex Balldriver (9/64") (RPI Part #RPT836)

Fits: Cassette Bay (Armature) • **Models:** 5000 & G4 5000

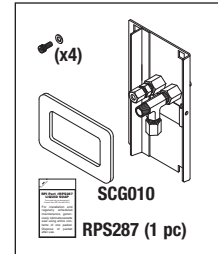

RPI Part #SCK048
OEM Part #01-109128S

COPPER TUBING KIT

- Includes all parts as shown
- Fits:** Probe Bracket to Boiler, Solenoid Valve and Alex Upgrade Kit
- Models:** 2000 & G4 2000

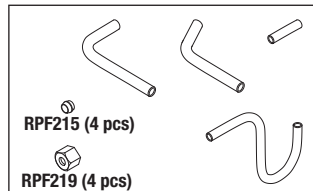

RPI Part #SCK049
OEM Part #01-109129S

COPPER TUBING KIT

- Includes all parts as shown
- Fits:** Probe Bracket to Boiler, Solenoid Valve and Alex Upgrade Kit
- Models:** 5000 & G4 5000

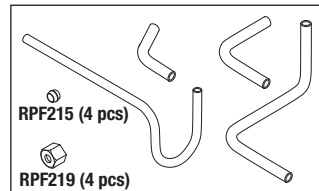

RPI Part #RPP943
OEM Part # (No OEM Part # Available)

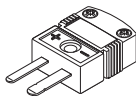

THERMOCOUPLE PLUG

- Use with Type K thermocouples
- Two male flat pin plug; Glass filled Nylon®; Shell color yellow
- Rated at -29°C to 180°C
- Accepts stranded or solid wire up to #20 AWG

Fits: For use with PCB's that have Thermocouple Plug Connections
Models: 2000, 5000, G4 2000 & G4 5000

RPI Part #SCT030
OEM Part # (No OEM Part # Available)

THERMOCOUPLE

- 6 - 6.5 Ω at room temperature
- Type K thermocouple
- Includes all parts as shown

Fits: Probe Bracket to PCB
Models: 2000, 5000, G4 2000 & G4 5000

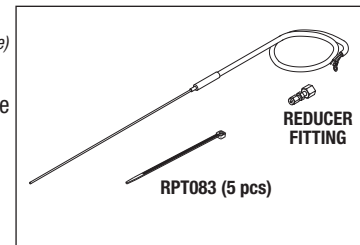

RPI Part #SCK007
OEM Part #01-100571S (2000)/
01-101621S (5000)

MICROSWITCH KIT

- 0.1A @ 125/250 VAC; SPST; N.O.; 26" lg. wires
- Includes all parts as shown
- RPI's Kit fits both the 2000 and 5000 series
- Also available: Hex Balldriver (5/64") (RPI Part #RPT297)

Fits: Probe Bracket
Models: 2000, 5000, G4 2000 & G4 5000

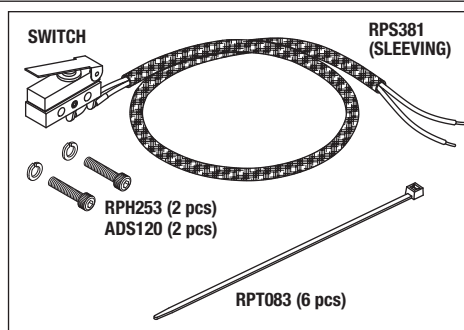

RPI Part #RPA874
OEM Part # (No OEM Part # Available)

ADHESIVE (RTV108)

- Size: 2.8 fl. oz. tube
- Translucent silicone adhesive/sealant
- Temperature Range: -75°F to +400°F
- Use to seal Microswitch to Probe Bracket
- Models:** 2000, 5000, G4 2000 & G4 5000

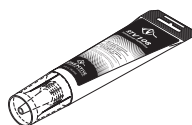

RPI Part #SCG010
OEM Part #01-100865S

PROBE BRACKET GASKET

- Material: Reticulated foam with adhesive backing
- Size: 2.19" x 3.38" x .12" Thk.
- Fits:** Cassette Bay (Armature)
- Models:** 2000, 5000, G4 2000 & G4 5000

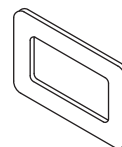

Two great tools to help make your job easier!

RPI Part #SCT052
ALIGNMENT TOOL

RPI exclusive tool to easily align probe bracket steam ports to the cassette!

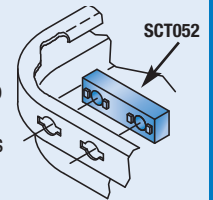

RPI Part #RPT836
HEX BALLDRIVER (10.5" lg.)

Allows easy access to probe bracket mounting screws for adjustment or replacement without removing other components!

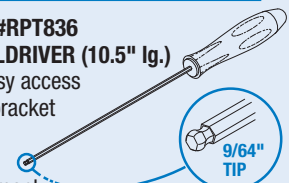

PM SERVICE TIP #1: A leaky check valve can cause moisture or steam to seep inside a compressor thus causing the compressor to fail. To avoid this problem, replace the check valve when replacing the compressor and replace the check valve every 2 years.

RPI Part #SCK020
OEM Part #01-100560S

AIR COMPRESSOR KIT

- 28mA @ 115 VAC; 50/60 Hz
- Rated air flow: 0.177 cfm
- Rated pressure: 2.84 PSI
- Wire leads: #22 AWG x 22" lg.
- Includes all parts as shown

Fits: Chassis
Models: 2000 & G4 2000

THE RPI ADVANTAGE

- The RPI tubing in the Check Valve Kit (RPI Part #SCK011) is translucent - making it easy to see a leaky check valve.
- For your convenience, RPI includes a check valve in the Air Compressor Kit (RPI Part #SCK020)!

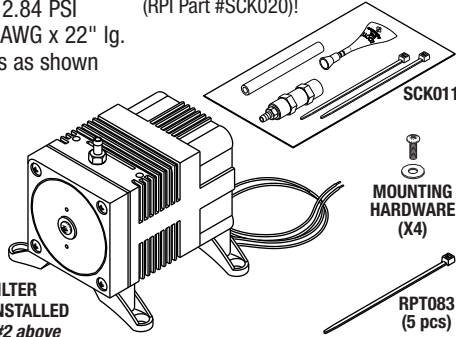

AIR COMPRESSOR WITH COMPRESSOR FILTER (RPI PART #SCF002) INSTALLED
See PM SERVICE TIP #2 above

RPI Part #SCK011
OEM Part #01-100574S/01-101627S

CHECK VALVE KIT

- 1/8" FPT; Brass; High temperature seals
- 3/16" brass barb fitting (installed)
- Includes all parts as shown

Fits: Steam Generator/Boiler to the Air Compressor
Models: 2000, 5000, G4 2000 & G4 5000

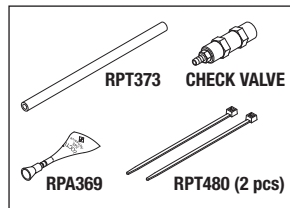

PM SERVICE TIP #2: The OEM recommends replacing the Compressor Filters every 6 months or every 500 cycles (whichever comes first).

RPI Part #SCF002
OEM Part #01-100207S

COMPRESSOR FILTER

- Size: 1.08" ID x 2.08" OD x .31" Thk.
 - Polyethylene/Polyurethane foam
 - 40 micron rating
 - Included in: Air Compressor Kit (RPI Part #SCK020)
- Fits:** Air Compressor
Models: 2000, G4 2000 & G4 5000

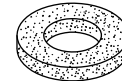

RPI Part #SCF031
OEM Part #01-101652S

AIR COMPRESSOR FILTER

- Size: .75" dia. x 1.63" lg.; 1/4" MPT
 - Pore size: 150-300 microns
 - Fits units with the MEDO Air Compressor only
- Fits:** Air Compressor
Models: 5000 & G4 5000

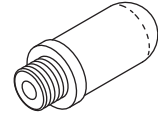

RPI Part #SCF032
OEM Part #01-102119S

BIOLOGICAL FILTER

- 3/16" ID hose connector
 - Size: 1.60" W x 2.70" lg. x .80" Thk.
 - Included in: Sterilizer PM Kits (RPI Part #'s SCK035 & SCK036)
- Fits:** Air Compressors
Models: 2000 (Serial 2101DK0274 and above), 5000, G4 2000 & G4 5000

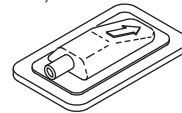

RPI Part #RPT647
OEM Part # (No OEM Part # Available)

TUBING (1/2" ID x 11/16" OD CLEAR)

- Material: Clear PVC
 - Sold by the foot (reel NOT included)
- Fits:** 2000 Pumps; and 5000 Medo Air Compressor and Filter (RPI Part #SCF031)
Models: 2000, 5000, G4 2000 & G4 5000

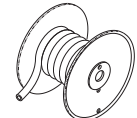

SERVICE TIP: To avoid damaging the solenoid valve flute/bonnet, it is recommended to use the Spanner Nut (RPI Part #RPT364) which is also included in the Double Ended Spanner Wrench (RPI Part #RPT501).

SERVICE TIP: The OEM recommends replacing the Safety Valve every 2 years.

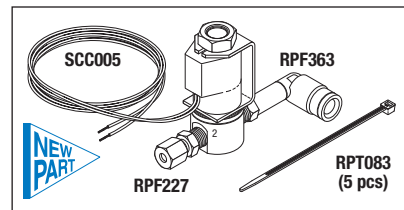

RPI Part #SCV064
OEM Part #01-100557S/01-101628S

SOLENOID VALVE

- Ports: 1/8" FPT; 2 Way; N.C.
- 120/110VAC, 50/60 Hz., 9 W
- #22 AWG x 23-1/2" lg. teflon wires
- Material: Stainless steel body, viton seals
- Includes all parts as shown

Fits: Bracket Assembly
Models: 2000, 5000, G4 2000 & G4 5000

RPI Part #SCC005
OEM Part # 01-104303S

COIL (SOLENOID VALVE)

- 120/110VAC, 50/60 Hz., 9 W
 - #22 AWG x 23-1/2" lg. teflon wires
- Fits:** RPI and the OEM's Solenoid Valve
Models: 2000, 5000, G4 2000 & G4 5000

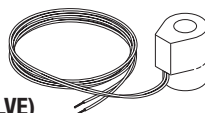

RPI Part #SCK003
OEM Part #01-100998S

SOLENOID VALVE REPAIR KIT

- Includes all parts as shown
- Fits:** Solenoid Valve
Models: 2000, 5000, G4 2000 & G4 5000

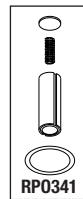

RPI Part #RPT364
OEM Part #01-103471S

SPANNER NUT (Stainless Steel)

- ID: .453"; Hex: .875"; Thk.: .25"
 - See **SERVICE TIP** above
- Models:** 900, 2000, 5000, G4 2000 & G4 5000

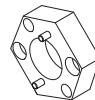

RPI Part #RPF363
OEM Part #01-100782S

PUSH-IN ELBOW FITTING

- 1/8" MPT; 1/4" OD tubing
 - Material: Nickel plated brass
 - Includes all parts as shown
- Fits:** Solenoid Valve, Port No. 1 (Exhaust)
Models: 2000, 5000, G4 2000 & G4 5000

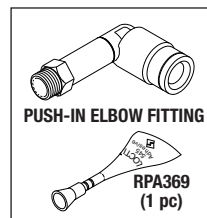

THE RPI ADVANTAGE

The RPI Push-In Elbow Fitting (RPI Part #RPF363) swivels! You can position the tubing where YOU want it. Plus, it prevents kinks in the exhaust tubing.

LOOK! EXTENDED SWIVEL ELBOW



IMPORTANT NOTE: The Push-In Elbow Fitting (RPI Part #RPF363) will not function properly with the OEM Teflon® Tubing. Only use with Nylon® Tubing (RPI Part #RPT380).

Table Top Sterilizers

Models: STATIM® 900, 2000, 5000, G4 2000 & G4 5000 Series (continued)

RPI Part #SCK062

OEM Part #01-104381S (Display only)/
01-109494S (Display only)

LCD KIT

- Includes all parts as shown

Fits: Fascia Cover

Model: 2000

Model #121101

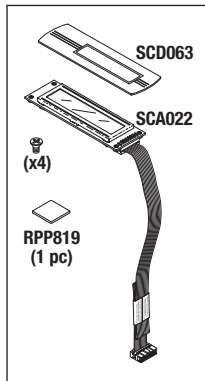

RPI Part #SCA022

OEM Part #01-104382S/01-104381S (Display only)/01-109494S (Display only)

DISPLAY ASSEMBLY

- Display Assembly can be used in all versions of the STATIM 2000 and 5000. It's the RPI Advantage!

- Includes all parts as shown

Fits: Fascia Cover

Models: 2000 & 5000

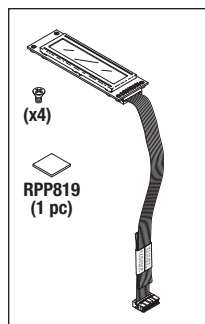

RPI Part #SCD063

OEM Part #01-106950S

LCD DECAL

Fits: Fascia Cover

Model: 2000

Model #121101

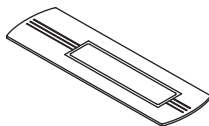

RPI Part #RPP819

OEM Part # (No OEM Part # Available)

MOUNTING PAD

- 10 per package
- Size: 3/4" x 3/4" x 1/16" Thk. foam
- Double sided adhesive
- It's the RPI Advantage! Use these mounting pads to attach keypad and display ribbon cables making it easier to install the top cover

Fits: Attaches the Keypad Ribbon Cable to the Display Ribbon Cable

Models: 2000, 5000, G4 2000 & G4 5000

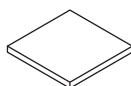

RPI Part #SCK040

OEM Part #01-109671S

KEYPAD

- Includes all parts as shown

Fits: Fascia Cover

Model: 5000 Model #01-201103

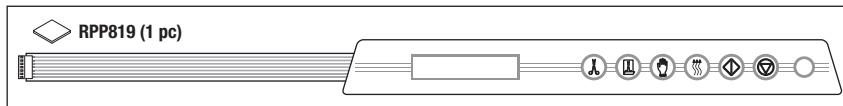

RPI Part #SCK041

OEM Part #01-109680S

KEYPAD

- 1 set of 2 pieces
- Includes all parts as shown
- Also available: Keypad (Old style) (RPI Part #SCK015)

Fits: Fascia Cover

Model: 2000 Model #121101 (New Type, Two Piece Style)

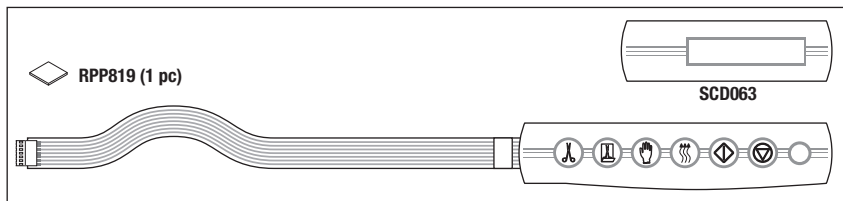

RPI Part #SCK015

OEM Part #01-101707S

KEYPAD

- Includes all parts as shown
- Also available: Keypad (New style) (RPI Part #SCK041)

Fits: Fascia Cover

Model: 2000 Model #101102 (Old type, one piece style with S/N's ending with an "A")

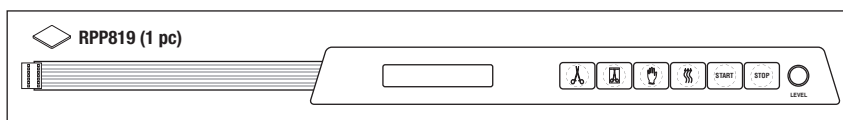

RPI Part #SCG009

OEM Part #01-100842S

FASCIA GASKET

- Material: High temperature grey neoprene sponge with adhesive backing
- Size: 2.67" x 8.57"

Fits: Fascia Cover

Models: 2000 & G4 2000

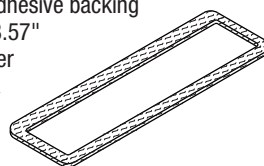

RPI Part #SCG044

OEM Part #01-101650S

FASCIA GASKET

- Material: High temperature grey neoprene sponge with adhesive backing
- Size: 4.35" x 8.81"

Fits: Fascia Cover

Model: 5000 & G4 5000

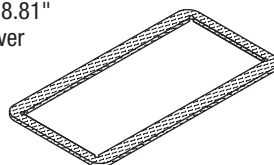

RPI Part #SCL012

OEM Part #01-100684S (KIT)

BUBBLE LEVEL

- 1" dia. x 0.44" tall with three #2 mounting holes
- Black plastic housing, glass window
- **Includes Bubble Level only**

Fits: Housing Assembly

Models: 2000 & 5000

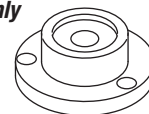

RPI Part #SCS023

OEM Part #01-100573S

POWER SWITCH

- Ratings: 16A @ 125-250VAC; DPST
- 3/16" tabs

Fits: Rear Panel

Models: 2000, 5000, G4 2000 & G4 5000

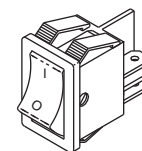

The RPI Advantage ...

One-of-a-kind design allows removal of the Condenser Waste Bottle from the exhaust tubing in one easy step. Simply push and release quick connect on lid and bottle is free from the exhaust tube for easy maintenance.

Waste Bottle comes completely assembled - simply connect the exhaust tube!

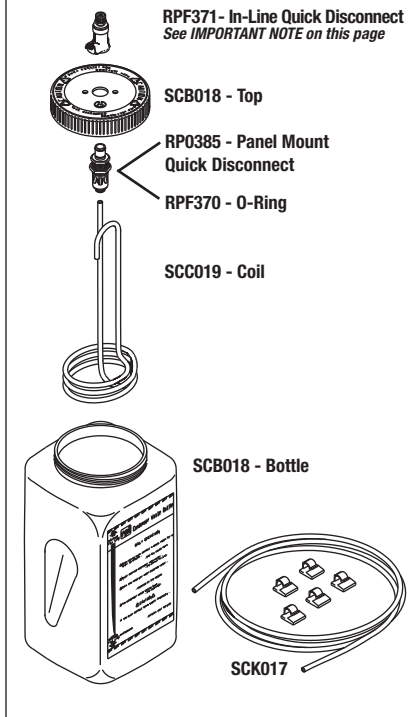

RPI PART #SCK016 OEM PART #01-100812S

CONDENSER WASTE BOTTLE KIT

- 1 gallon capacity; Polypropylene
- Includes all parts as shown
- **Regarding the In-Line Quick Connect, (RPI Part #RPF371) - See IMPORTANT NOTE on this page**

Fits: Vent Solenoid Valve Fitting
Models: 900, 2000 & 5000



RPI Part #RPF371

OEM Part # (No OEM Part # Available)

IN-LINE QUICK DISCONNECT

- See **IMPORTANT NOTE on this page**
- Size: 1/4" Ferrules Polytube fitting
- Mates with RPI's Panel Mount Quick Disconnect (RPI Part #RPF370)
- Without shut-off

Models: 900, 2000 & 5000 with RPI Condenser Waste Bottle Kit (RPI Part #SCK016)

IMPORTANT NOTE REGARDING RPI PART #'s RPF371 & RPF363

The In-Line Quick Disconnect (RPI Part #RPF371) and the Push-In Elbow Fitting (RPI Part #RPF363) will not function properly with the OEM Teflon® Tubing. Only use with the supplied Nylon® Tubing (RPI Part #SCK017).

RPI Part #SCB018 OEM Part #01-100724S

WASTE BOTTLE WITH LID

Models: 900, 2000 & 5000 with RPI Condenser Waste Bottle Kit (RPI Part SCK016)

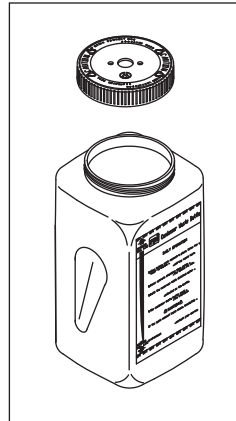

RPI Part #RP0385

OEM Part # (No OEM Part # Available)
Industry Part #2-011

O-RING

- 12 per package
- Material: Viton®
- Hardness: 60 Duro
- .301" ID x .441" OD x .070" C/S

Fits: Panel Mount Quick Disconnect (RPI Part #RPF370)
Models: 900, 2000 & 5000 with RPI Condenser Waste Bottle Kit (RPI Part #SCK016)



Actual Size

RPI Part #RPF370

OEM Part # (No OEM Part # Available)

PANEL MOUNT QUICK DISCONNECT

- Mates with RPI's In-Line Quick Disconnect (RPI Part #RPF371)
- 1/4" tubing Push-in Fitting
- Includes all parts as shown

Models: 900, 2000 & 5000 with RPI Condenser Waste Bottle Kit (RPI Part SCK016)

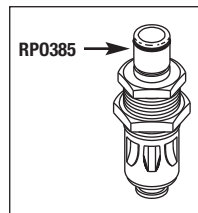

RPI Part #RPF363 OEM Part #01-100782S

PUSH-IN ELBOW FITTING

- See **IMPORTANT NOTE to the left**
- 1/8" MPT; 1/4" OD Push-in Fitting
- Material: Nickel plated brass
- Extended swivel elbow -

See **The RPI Advantage** on page 1504

• Includes all parts as shown
Fits: Solenoid Valve
Models: 2000 & 5000

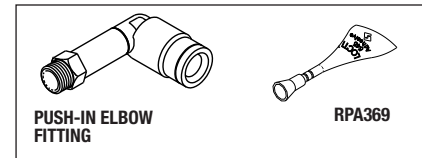

PUSH-IN ELBOW FITTING

RPA369

RPI Part #SCC019

OEM Part # (No OEM Part # Available)

CONDENSATION COIL

- 1/4" OD copper tubing
- Fits:** Condenser Waste Bottle Kit (RPI Part #SCK016) only
Models: 900, 2000, & 5000

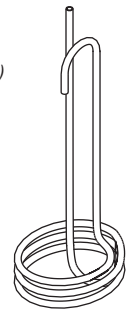

RPI Part #SCK017 OEM Part #01-100204S

EXHAUST TUBING KIT

- Includes all parts as shown
 - Tubing: 8 ft. lg; Nylon®, .250" OD x .170" ID
- Fits:** Solenoid Valve Fitting to Waste Bottle Fitting
Models: 900, 2000 & 5000

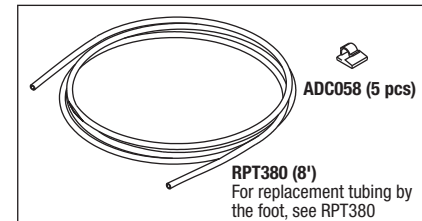

ADC058 (5 pcs)

RPT380 (8')
For replacement tubing by the foot, see RPT380

RPI Part #ADC058

OEM Part # (No OEM Part # Available)

CORD CLIP - (10/PKG)

- 3/8" bundle size
 - Natural Nylon® with adhesive backing
 - Meets UL94V-2 Flame Class
- Models:** 900, 2000 & 5000



RPI Part #RPT380

OEM Part # (No OEM Part # Available)

EXHAUST TUBING

- Sold by the foot (reel NOT included)
 - Size: .250" OD x .170" ID
 - Material: Nylon®
- Fits:** Solenoid Valve Fitting to the Waste Bottle Fitting
Models: 900, 2000 & 5000

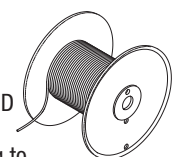

Table Top Sterilizers

Models: STATIM® 900, 2000 & 5000 Series (continued)

Upgrade your 2000 or 5000 with an RPI "Quick-Release Drain System"!

Upgrade the 2000!

RPI Part #SCK037
OEM Part #01-108152S (Kit)/
01-106637S (Kit)

DRAIN KIT WITH PUMP FILTER

- Includes all parts as shown
- Fits:** From the Reservoir to the Pump Filter to the Pump to the Drain Line
- Model:** 2000

Upgrade the 5000!

To upgrade the 5000, just ask for these two RPI parts:

- **FEMALE Q.C. FITTING** (RPI Part #RPF428)
- **DRAIN TUBING** (RPI Part #RPK432)

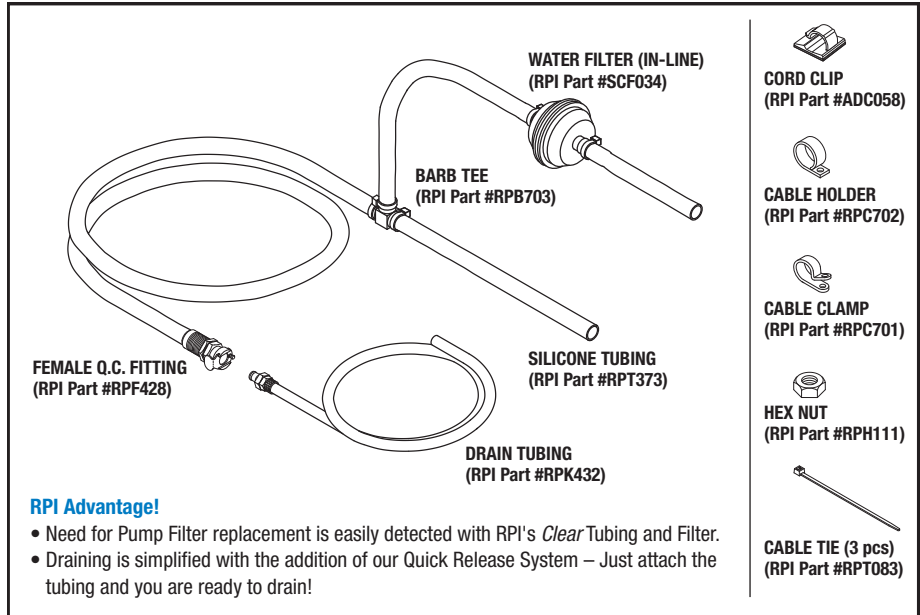

RPI Advantage!

- Need for Pump Filter replacement is easily detected with RPI's Clear Tubing and Filter.
- Draining is simplified with the addition of our Quick Release System – Just attach the tubing and you are ready to drain!

ALL PARTS IN KIT ALSO SOLD SEPARTELY – SEE BELOW.

RPI Part #ADC058
OEM Part # (No OEM Part # Available)

CORD CLIP - (10/PKG)

- 3/8" bundle size
- Natural Nylon® with adhesive backing
- Models:** 900, 2000, 5000



RPI Part #RPB703
OEM Part #01-108152S (Kit)

BARB TEE - (5/PKG)

- White Nylon®
- Tee tube fitting with barbs for use with 3/16" ID tubing
- Use with Tubing (RPI Part #RPT373)
- Fits:** Drain Tubing Kit
- Model:** 2000

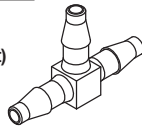

RPI Part #RPC701
OEM Part #01-108152S (Kit)

CABLE CLAMP - (5/PKG)

- 1/4" bundle size
- Nylon®; #8 mounting hole
- Fits:** Drain Tubing Kit
- Model:** 2000



RPI Part #RPC702
OEM Part #01-108152S (Kit)

CABLE HOLDER - (5/PKG)

- 3/8" bundle size
- Nylon®; #10 mounting hole
- Flexible loop for ease of installing and removing tubing
- Fits:** Drain Tubing Kit
- Model:** 2000



RPI Part #RPF428
OEM Part # (No OEM Part # Available)

FEMALE QUICK CONNECT FITTING (WHITE)

- Tubing size: .250" OD x .170" ID; Flow: 1/8"; 1.720" lg.
- Fits:** Front Panel/Drain Tube Assembly Kit - Small (RPI Part #RPK432) and Male Quick Connect Fitting (RPI Part #RPF429)
- Models:** 2000 & 5000

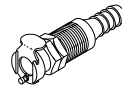

RPI Part #RPK432
OEM Part # (No OEM Part # Available)

DRAIN TUBE ASSEMBLY

- Fitting: Acetal; Tubing: Clear Polyethylene (.250" OD x .035" Wall); ~50" lg.
- Includes all parts as shown
- Fits:** Front Panel/Female Quick Connect Fitting-White (RPI Part #RPF428)
- Models:** 2000 & 5000

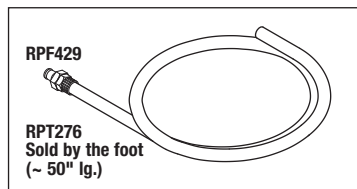

RPI Part #RPH111
OEM Part # (No OEM Part # Available)

HEX NUT (#8-32) - (50/PKG)

- Size: #8-32; stainless steel
- Fits:** Drain Tubing Kit
- Models:** 2000 & 5000



RPI Part #RPT083
OEM Part # (No OEM Part # Available)

CABLE TIE (4" WHITE) - (25/PKG)

- Nylon®
- Fits:** Drain Tubing Kit
- Models:** 900, 2000 & 5000



RPI Part #RPT373
OEM Part # (No OEM Part # Available)

SILICONE TUBING

- Sold by the foot (Reel not included)
- 3/16" ID x 5/16" OD;
- Translucent natural silicone
- Temp Rating: Up to 500°F
- Models:** 2000 & 5000

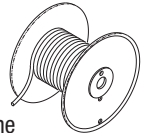

RPI Part #SCF034
OEM Part #01-106637S

WATER FILTER (IN-LINE)

- 3/16" ID hose connectors; 1-1/4" dia. body; overall length: 2"
- Plastic body, wire mesh element
- Includes all parts as shown
- **PM SERVICE TIP:** The OEM recommends replacing the filter every 6 months or every 500 cycles (whichever comes first)

- Fits:** Water Pumps
- Models:** 900, 2000 & 5000

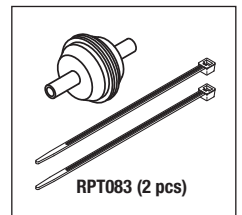

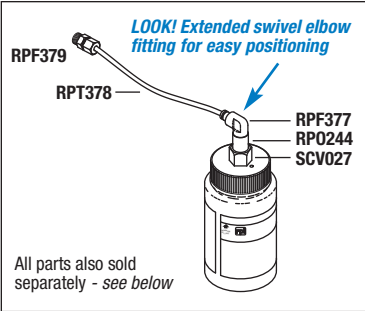

RPI Part #SCK024
OEM Part #01-100713S

PUMP TESTER BOTTLE KIT

- Use to test pump
- Includes all parts as shown
- Also included in: RPI Field Service Smart Kit® (RPI Part #SCK028)

Models: 2000 & 5000

RPI Part #RPF379
OEM Part # (No OEM Part # Available)

UNION FITTING (COMPRESS-ALIGN 1/8")

- 1/8" OD tubing; Brass

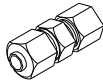

Models: 2000 & 5000

RPI Part #RPT378
OEM Part # (No OEM Part # Available)

1/8" OD TEFLON® TUBING

- Sold by the foot
- Temp rating: 400°F
- 1/8" OD

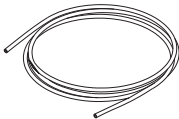

Models:
2000 & 5000

RPI Part #RPF377
OEM Part # (No OEM Part # Available)

PUSH-IN ELBOW FITTING

- 1/8" FPT
- Extended swivel elbow
- 1/8" OD tubing
- Material: Nickel plated brass

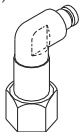

Models: 2000 & 5000

RPI Part #RPO244
OEM Part # (No OEM Part # Available)

PUSH-IN ELBOW FITTING

- 6 per package
- .296" ID x .574" OD x .139" c/s
- Material: Red silicone; DURO: 60



Actual Size

Models: 2000 & 5000

RPI Part #SCV027
OEM Part # (No OEM Part # Available)

SAFETY VALVE (38 PSI)

- 1/8" MPT
- Cracking pressure: 38 PSI

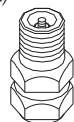

Models: 2000 & 5000

RPI Part #SCK025
OEM Part #01-100572S

POWER CORD REPLACEMENT KIT

- 7 ft. lg.; 15A @ 125VAC, 105°C
- Plug: Nema 5-15; 14/3 conductor SJT
- Includes all parts as shown

Fits: Chassis/Rear Panel
Model: 2000

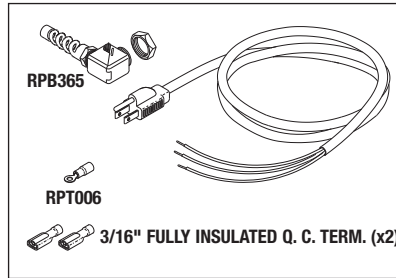

RPI Part #RPB365
OEM Part #53-100518A

90° LIQUID TIGHT STRAIN RELIEF WITH LOCKING NUT

- Nylon®; 1.06" height from the panel
- Mounting hole: 3/4" dia.

Fits: Power Cord to Chassis
Model: 2000

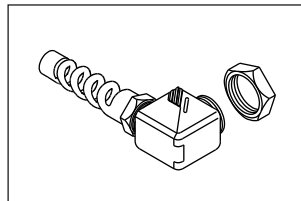

RPI Part #RPC288
OEM Part # (No OEM Part # Available)

POWER CORD

- 7 ft. with outer jacket striped 10"
- 15A @ 125VAC; 105°C
- Plug: NEMA 5-15; 14/3 conductor SJT
- Includes all parts as shown
- For use and mounts with Strain Relief Bushing (RPI Part #RPB365)

Fits: Chassis/Rear Panel
Models: 2000

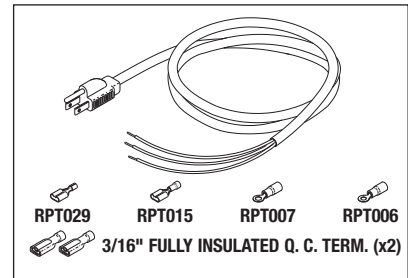

RPI Part #RPC291
OEM Part #01-101647S

POWER CORD

- 6 ft. lg.; 15 AMPS @ 125VAC, 105°C
- 14/3 conductor
- Plug: NEMA 5-15, C13 R (right angle)

Fits: Power Entry Filter Module
Models: 2000 & 5000

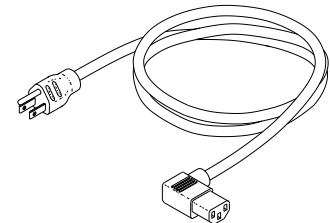

NOTES: _____

Table Top Sterilizers

Models: STATIM® 900, 2000 & 5000 Series (continued)

RPI Part #RPF362
OEM Part #01-101553S

LEVELER LEG

- 4 per package
- 1/4-20 x 1-1/2" lg. stem
- Nylon® base with 7/8" hex for ease of adjustments

Fits: Chassis/Base

Models: 2000 & 5000

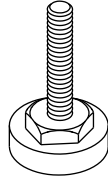

RPI Part #CAF011
OEM Part # (No OEM Part # Available)

RUBBER FOOT

- 4 per package
- Material: Black rubber with molded in steel washer
- Size: ~.750" O.D. x .50" lg.; 10 clearance hole

Fits: Base Plate

Models: 2000 & 5000





RPI Part #RPH817
OEM Part # (No OEM Part # Available)

SCREW (#8-32 x .500 SEMS)

- 25 per package; Material: Zinc-plated steel
- Size: #8-32 x 1/2" lg. with captive external lockwasher

Fits: Cover, Solenoid Valve Mounting Bracket, Steam Generator/Boiler to Bracket, STATIM 5000 Air Compressor Mounting Bracket & Rear Foot
Models: 2000 & 5000

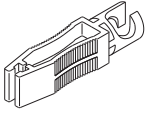

FUSES					Also available:	
						
RPF060 & RPF061	RPF071	RPF367 & RPF368			RPI Part #RPT502 FUSE PULLER • Removes or installs glass or ceramic fuses	
RPI PART #	OEM PART #	DESCRIPTION	# PER PKG	SIZE	TYPE	MODELS
RPF060*	No OEM Part # Available	Fuse (1/2A,250V) - Time Delay Fits: Fuse holder on Main PC board marked "F3" and "F4"	5	1/4" dia. x 1-1/4" lg.	Glass	2000 (older styles only)
RPF061*	No OEM Part # Available	Fuse (1A,250V) - Time Delay Fits: Fuse holder below Main PC board	5	1/4" dia. x 1-1/4" lg.	Glass	2000 (older styles only)
RPF071*	01-103472S	Fuse (15A,250V) - Time Delay Fits: Fuse holder on Main PC board marked "F1" and "F2" in older styles; and, "F2" and "F3" in newer styles	5	1/4" dia. x 1-1/4" lg.	Ceramic	2000, 5000
RPF367**	01-103498S	Fuse (2A,250V) - ACG Fast Acting Fits: Fuse holder on newer style Main PC boards marked "F1"	5	5mm dia. x 20mm lg.	Glass	2000, 5000
RPF368***	01-103497S	Fuse (1/4A,250V) - Time Delay Fits: Fuse holder on newer style Main PC boards marked "F4"	5	5mm dia. x 20mm lg.	Glass	2000, 5000

* Also Included in: Fuse Kit (RPI Part #RPK411) ** Also Included in: Fuse Kit (RPI Part #RPK520) *** Also Included in: Fuse Kit (RPI Part #RPK538)

HOOK UP WIRE
• Sold by the foot (reel NOT included)



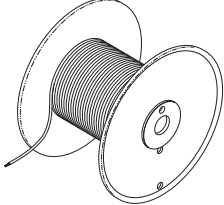

RPI PART #	DESCRIPTION	AWG	VOLTAGE RATING	INSULATION	MAX TEMP	MODELS
RPW382*	Hook Up Wire (Black)	#14	600V	Polyolefin	257°F	900, 2000, 5000
RPW805*	Hook Up Wire (White)	#14	600V	Polyolefin	257°F	900, 2000, 5000
RPW806*	Hook Up Wire (Grn/Yel)	#14	600V	Polyolefin	257°F	900, 2000, 5000
RPW813	Hook Up Wire (Black)	#22	600V	PVC	221°F	900, 2000, 5000
RPW814	Hook Up Wire (White)	#22	600V	PVC	221°F	900, 2000, 5000
RPW815	Hook Up Wire (Grn/Yel)	#22	600V	PVC	221°F	900, 2000, 5000

* Non-Teflon®

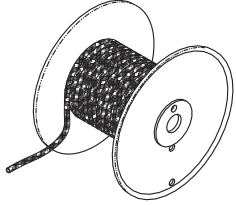

RPI Part #RPS381
OEM Part # (No OEM Part # Available)

HIGH TEMPERATURE SLEEVING

- Sold by the foot (reel NOT included)
- 5/32" ID expands to 3/16" ID
- Temperature rating: -67°F to +392°F
- High current protection

Models: 900, 2000 & 5000

RPI Part #RPT480
OEM Part # (No OEM Part # Available)

CABLE TIES (HIGH TEMP)

- 25 per package
- Size: 1/8" x 4" lg.
- Material: Tefzel®, Color: Aqua blue
- Temp rating: Up to 338°F

Models: 900, 2000 & 5000

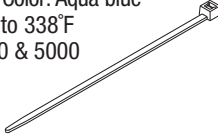

RPI Part #RPT083
OEM Part # (No OEM Part # Available)

CABLE TIE (4" WHITE)

- 25 per package
- Size: 1/8" x 4" lg.
- Material: Nylon®, Color: White

Models: 900, 2000 & 5000



RPI Part #RPT482
OEM Part # (No OEM Part # Available)

TERMINAL CRIMP TOOL

- ~8-1/4"
- Material: Steel with cushion grip handles
- Wire stripper - AWG #10 to #22
- Crimps #10 to #22 insulated and non-insulated terminals; Cuts #4-40 to #10-32 screws
- Includes pliers at tip, wire loop former and wire cutter



RPI Part #RCG019
OEM Part # (No OEM Part # Available)

GASKET
 • 7.5" OD x .218" dia. C/S
 • White silicone
Fits: Chamber
Model: 714

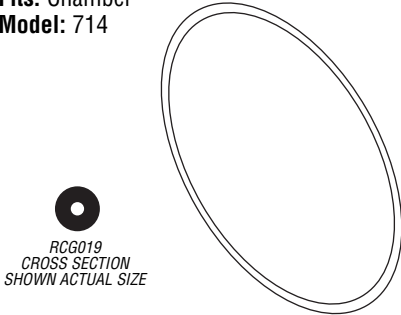

RPI Part #SPG001
OEM Part #P-77117-111
DOOR GASKET (TEFLON® ENCAPSULATED)

• 7.42" OD x .22" C/S
Fits: Door
Model: 750

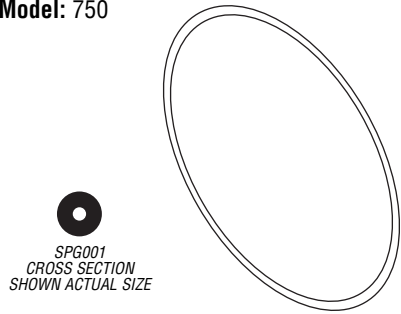

RPI Part #RCB002
OEM Part # (No OEM Part # Available)

BELLOWS ASSEMBLY
 • Includes bellows, and compression nut
 • Mounts in reservoir
Model: 714

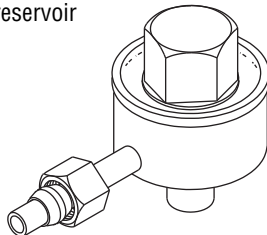

RPI Part #SPH002
OEM Part #P77117-31

HEATING ELEMENT
 • 1200 W, 120VAC, ~12Ω
 • Includes all parts as shown
Fits: Bottom of chamber
Model: 750

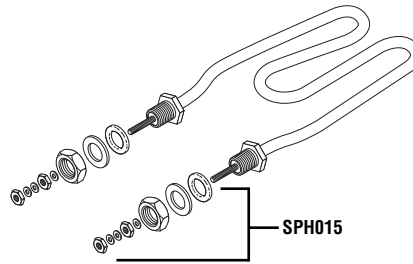

RPI Part #SPH015
OEM Part # (No OEM Part # Available)

HEATER MOUNTING HARDWARE
 • Includes all parts as shown
Fits: Heater (RPI Part #SPH002)
Model: 750

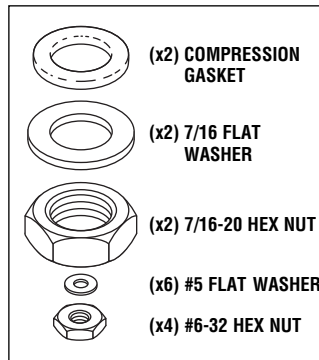

RPI Part #RCB003
OEM Part # (No OEM Part # Available)

THERMAL DIAPHRAGM BELLOWS ASSEMBLY
 • Includes all parts as shown
Model: 714

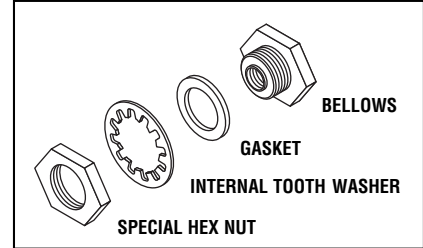

RPI Part #RCV051
OEM Part # (No OEM Part # Available)

PRESSURE RELIEF SAFETY VALVE
 • Cracking Pressure: 31 PSI
 • Brass; 1/8" MPT
Model: 714

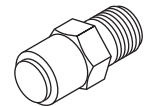

RPI Part #SPL011
OEM Part #P-77117-143

PILOT LIGHT (RED)
 • 125VAC, 1/3 W
Fits: Control Panel
Model: 750

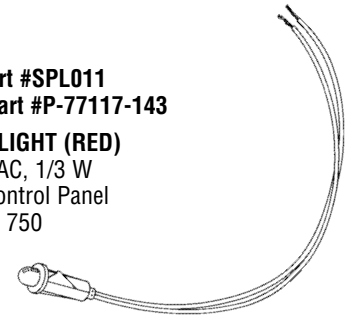

RPI Part #SPL012
OEM Part #P-77117-144

PILOT LIGHT (GREEN)
 • 125VAC, 1/3 W
Fits: Control Panel
Model: 750

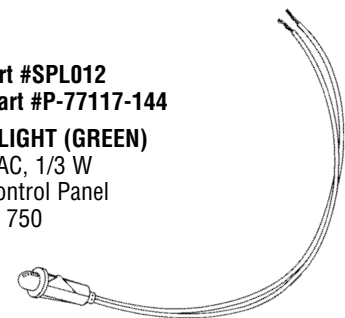

RPI Part #SPL013
OEM Part #P-77117-145

PILOT LIGHT (AMBER)
 • 125VAC, 1/3 W
Fits: Control Panel
Model: 750

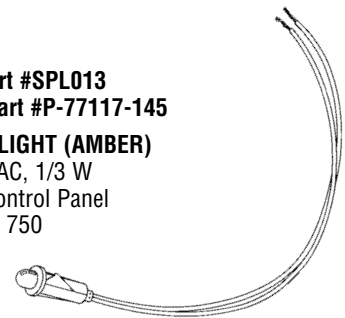

DON'T FORGET!

RPI Part #RPA032
THREADLOCKER 242

- 5 per package
- .02 fl. oz. per unit
- Prevents rust and corrosion
- Removable adhesive by Loctite®

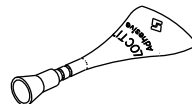

Visit the RPI website
www.rpiparts.com

Table Top Sterilizers

Models: 714 & 750 (continued)

RPI Part #RCH118
OEM Part # (No OEM Part # Available)

HEATING ELEMENT ASSEMBLY

- 1136W, 118VAC, ~12Ω
 - Includes all parts as shown
 - Mounts inside chamber
- Model:** 714

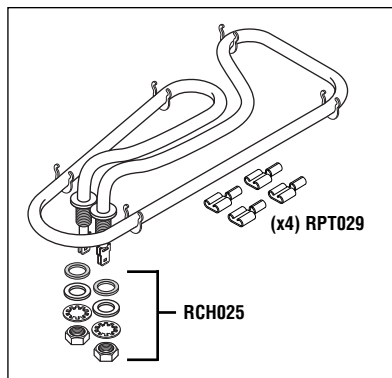

RPI Part #RCH119
OEM Part # (No OEM Part # Available)

ATTACHING HARDWARE

- Includes all part as shown
- Fits:** Heating Element Assembly (RPI Part #RCH118) only
- Model:** 714

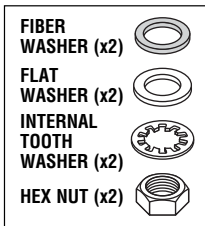

RPI Part #SPT004
OEM Part #P-77117-137

DIAL THERMOMETER

- Reads: 60° F-300° F/20° C-130° C, 0-27 PSIG
 - 1/4" MPT, 2" dia. dial face, 2" Stem
- Model:** 750

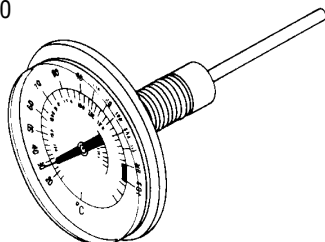

RPI Part #SPB005
OEM Part #P-77117-119

THERMOMETER BUSHING (SILICONE)

- 3 per package
- Fits:** Thermometer Shaft
- Model:** 750



RPI Part #RCT048
OEM Part #P77117-132

TIME SWITCH (60 MIN)

- Use this timer to replace a timer with a built-in bell. This timer will not work in conjunction with machines that utilize an independent buzzer (RPI Part #RCB096)
 - 60 minute mechanical time switch
 - SPST
 - Includes all parts as shown
- Model:** 750 (S.S. White) & 714 (Spectroline)

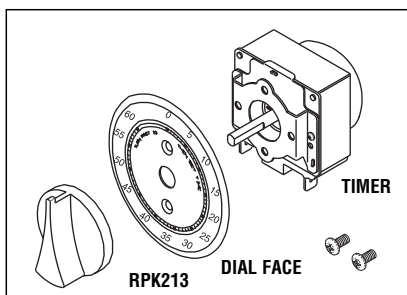

RPI Part #RPK213
OEM Part # (No OEM Part # Available)

KNOB

- Fits:** Time Switch (RPI Part #RCT048) only
- Model:** 750 (S.S. White) & 714 (Spectroline)



RPI Part #SPB008
OEM Part #P-77117-37

AIR RELEASE BELLOWS

- Fits:** Manifold Assembly
- Model:** 750

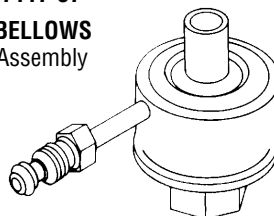

RPI Part #SPV009
OEM Part #P-77117-141

SAFETY VALVE (33 PSI)

- Cracking Pressure: 33 PSI
 - 1/8" MPT
- Fits:** Manifold Assembly
- Model:** 750



RPI Part #SPT010
OEM Part #P-77117-139

OVERTEMP THERMOSTAT

- Manual reset
 - Opens @ 300°F
 - Includes overtemp thermostat, and (2) terminal screw
 - Mounts on exterior of chamber
- Model:** 750

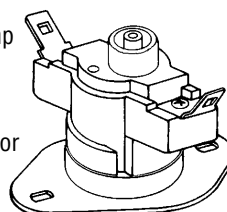

RPI Part #SPV006
OEM Part #P-7717-212

FILL VENT VALVE

- Fits:** Valve Bracket Assembly
- Model:** 750

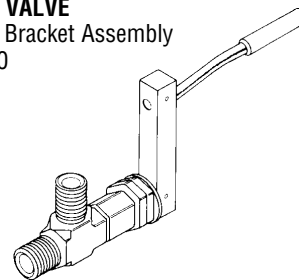

RPI Part #RCS097
OEM Part # (No OEM Part # Available)

VALVE STEM KIT

- Includes all parts as shown
 - Use to repair Fill Vent Valve (RPI Part #SPV014) which is no longer available
- Fits:** Fill-Vent Valve (RPI Part # SPV014)
- Models:** 750 (S.S. White)

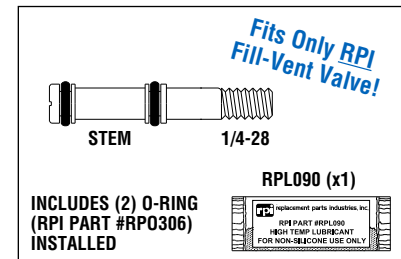

RPI Part #PCC004
OEM Part # (No OEM Part # Available)

POWER CORD WITHOUT CONNECTORS

- 8 ft.
 - 16/3 conductor
 - Type: HSJO (90°C heater cord)
- Fits:** Tabletop Sterilizers

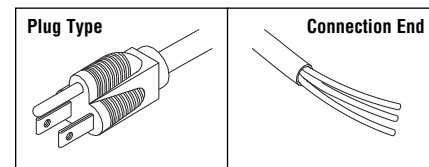

RPI Part #RPT113
OEM Part # (No OEM Part # Available)

MAX REGISTER THERMOMETER

- Mercury
- Length: 5-1/2"
- Accuracy Rating: ±1 Division (±2°F)
- Range: 150°F to 350°F
- Includes thermometer, and metal protective case

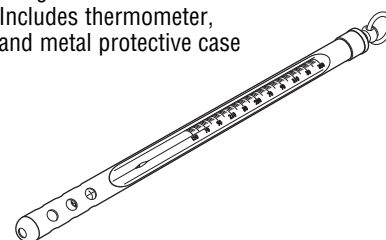

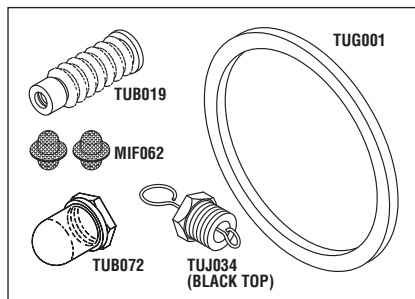

RPI Part #TUK121
OEM Part #02610020*

STERILIZER PM KIT

- Includes all parts as shown plus a PM Checklist and PM Sticker for recording the date that these parts were replaced. All parts also sold separately. *It's the RPI Advantage!*

Models: 1730E/M

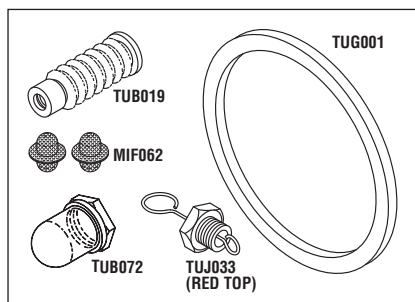

RPI Part #TUK122
OEM Part #02610020*

STERILIZER PM KIT

- Includes all parts as shown plus a PM Checklist and PM Sticker for recording the date that these parts were replaced. All parts also sold separately. *It's the RPI Advantage!*

Models: ValueKlave (1730MKV) & 1730EK/MK

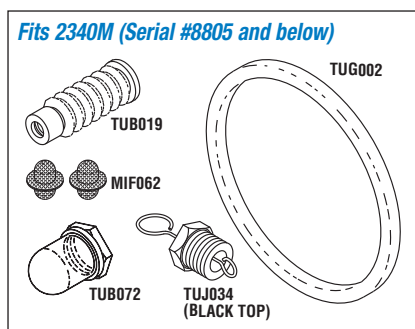

RPI Part #TUK123
OEM Part #02610005*

STERILIZER PM KIT

- Includes all parts as shown plus a PM Checklist and PM Sticker for recording the date that these parts were replaced. All parts also sold separately. *It's the RPI Advantage!*

Model: 2340M (Serial #8805 and below)

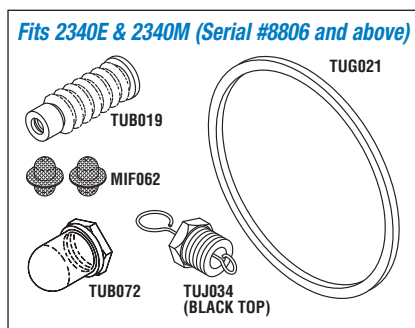

RPI Part #TUK124
OEM Part #02610118*

STERILIZER PM KIT

- Includes all parts as shown plus a PM Checklist and PM Sticker for recording the date that these parts were replaced. All parts also sold separately. *It's the RPI Advantage!*

Models: 2340E & 2340M (Serial #8806 and above)

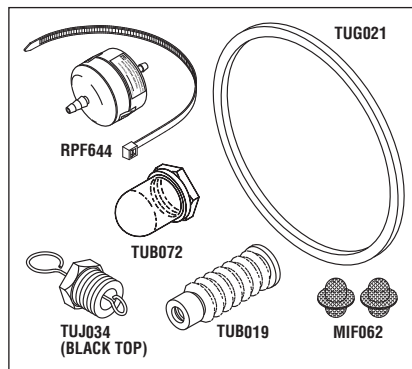

RPI Part #TUK125
OEM Part #02610118*

STERILIZER PM KIT

- Includes all parts as shown plus a PM Checklist and PM Sticker for recording the date that these parts were replaced. All parts also sold separately. *It's the RPI Advantage!*

Models: EZ9 & 2340EA

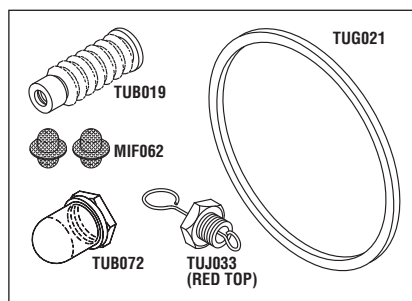

RPI Part #TUK126
OEM Part #02610118*

STERILIZER PM KIT

- Includes all parts as shown plus a PM Checklist and PM Sticker for recording the date that these parts were replaced. All parts also sold separately. *It's the RPI Advantage!*

Models: 2340EK/MK

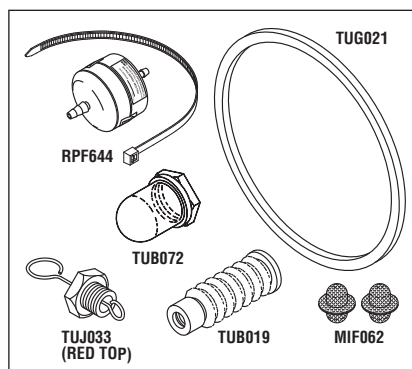

RPI Part #TUK127
OEM Part #02610118*

STERILIZER PM KIT

- Includes all parts as shown plus a PM Checklist and PM Sticker for recording the date that these parts were replaced. All parts also sold separately. *It's the RPI Advantage!*

Model: EZ9k & 2340EKA

* **Note:** OEM Part # shown references the "Door Gasket only" and does not represent the entire Sterilizer PM Kit.

Table Top Sterilizers

Models: EZ9, EZ9k, EZ10, EZ10k, ValueKlave (1730MKV)™, 1730, 2340, 2540, 3850 & 3870 Series

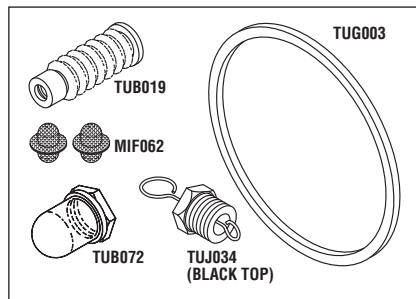

RPI Part #TUK128
OEM Part #02610023*

STERILIZER PM KIT

- Includes all parts as shown plus a PM Checklist and PM Sticker for recording the date that these parts were replaced. All parts also sold separately. *It's the RPI Advantage!*

Models: 2540E/M

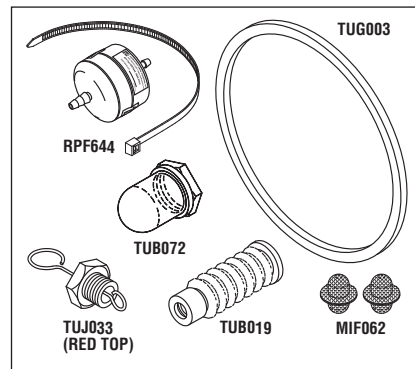

RPI Part #TUK129
OEM Part #02610023*

STERILIZER PM KIT

- Includes all parts as shown plus a PM Checklist and PM Sticker for recording the date that these parts were replaced. All parts also sold separately. *It's the RPI Advantage!*

Models: EZ10k & 2540EKA

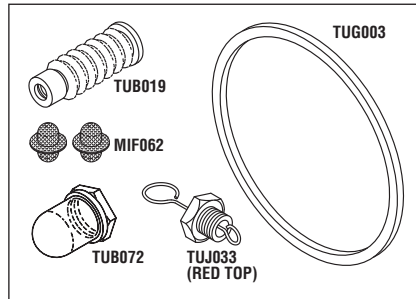

RPI Part #TUK130
OEM Part #02610023*

STERILIZER PM KIT

- Includes all parts as shown plus a PM Checklist and PM Sticker for recording the date that these parts were replaced. All parts also sold separately. *It's the RPI Advantage!*

Models: 2540EK/MK

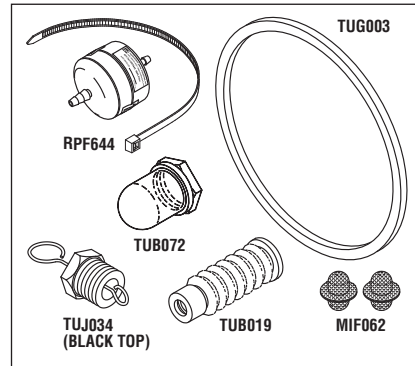

RPI Part #TUK133
OEM Part #02610023*

STERILIZER PM KIT

- Includes all parts as shown plus a PM Checklist and PM Sticker for recording the date that these parts were replaced. All parts also sold separately. *It's the RPI Advantage!*

Models: EZ10 & 2540EA/EHS

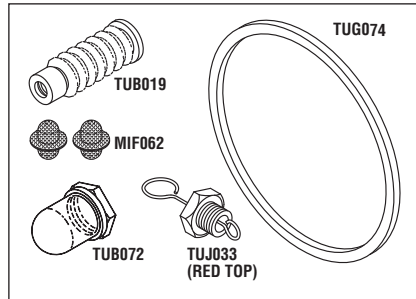

RPI Part #TUK131
OEM Part #02610019*

STERILIZER PM KIT

- Includes all parts as shown plus a PM Checklist and PM Sticker for recording the date that these parts were replaced. All parts also sold separately. *It's the RPI Advantage!*

Models: 3850E/M & 3870E/M

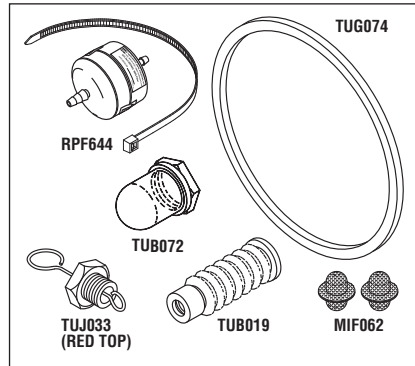

RPI Part #TUK132
OEM Part #02610019*

STERILIZER PM KIT

- Includes all parts as shown plus a PM Checklist and PM Sticker for recording the date that these parts were replaced. All parts also sold separately. *It's the RPI Advantage!*

Models: 3850EA & 3870EA

* Note: OEM Part # shown references the "Door Gasket only" and does not represent the entire Sterilizer PM Kit.

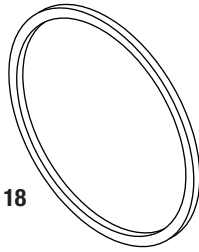
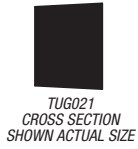

RPI Part #TUG021
OEM Part #02610118

DOOR GASKET

- 9.50" OD
- Models:** EZ9, EZ9k, 2340E/EA/EK/EKA & 2340M & 2340MK (Serial #8806 and above)

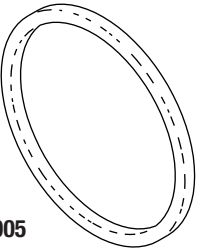

RPI Part #TUG002
OEM Part #02610005

DOOR GASKET

- 9.42" OD
- Model:** 2340M (Serial #8805 and below)

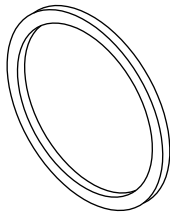
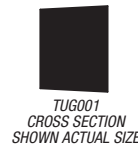

RPI Part #TUG001
OEM Part #02610020

DOOR GASKET

- 7.37" OD
- Models:** ValueKlave (1730MKV) & 1730E/EK/M/MK

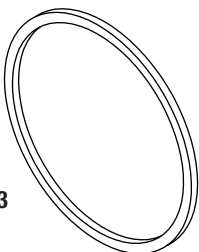

RPI Part #TUG003
OEM Part #02610023

DOOR GASKET

- 10.59" OD
- Models:** EZ10, EZ10k & 2540E/EA/EK/EKA/M/MK

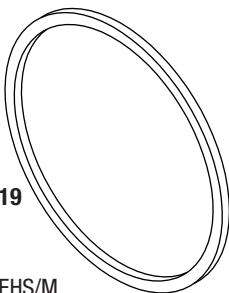

RPI Part #TUG074
OEM Part #02610019

DOOR GASKET

- 15.94" OD
- Models:** 3850E/EA/EHS/M & 3870E/EA/EHS/M

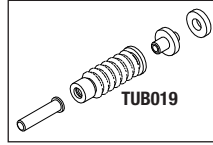

RPI Part #TUK030
OEM Part #CT241111

DOOR BELLOWS ASSEMBLY KIT

- Includes all parts as shown
- Fits:** Door
- Models:** EZ9, EZ9k, EZ10, EZ10k, ValueKlave (1730MKV), 1730E/EK/M/MK, 2340E/EA/EK/EKA/M/MK, 2540E/EA/EHS/EK/EKA/M/MK, 3850E/EA/EHS/M & 3870E/EA/EHS/M

RPI Part #TUB019
OEM Part # (No OEM Part # Available)

DOOR BELLOWS

- Material: Blue silicone
- Fits:** Door
- Models:** EZ9, EZ9k, EZ10, EZ10k, ValueKlave (1730MKV), 1730E/EK/M/MK, 2340E/EA/EK/EKA/M/MK, 2540E/EA/EHS/EK/EKA/M/MK, 3850E/EA/EHS/M & 3870E/EA/EHS/M

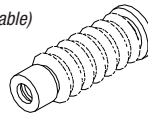

RPI Part #TUH158
OEM Part #CT241010

DOOR BELLOWS HOUSING

- Size: .57" O.D. x 2.12" lg.
- Material: Brass
- Fits:** Door
- Models:** EZ9, EZ9k, EZ10, EZ10k, ValueKlave (1730MKV), 1730E/EK/M/MK, 2340E/EA/EK/EKA/M/MK, 2540E/EA/EHS/EK/EKA/M/MK, 3850E/EA/EHS/M & 3870E/EA/EHS/M

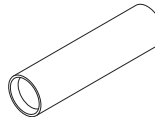

RPI Part #TUB064
OEM Part #CT245010

DOOR BELLOW HOUSING BOLT

- 3/8-19 BSPP; Material: Brass
- Fits:** Door
- Models:** EZ9, EZ9k, EZ10, EZ10k, ValueKlave (1730MKV), 1730E/EK/M/MK, 2340E/EA/EK/EKA/M/MK, 2540E/EA/EHS/EK/EKA/M/MK, 3850E/EA/EHS/M & 3870E/EA/EHS/M

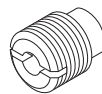

RPI Part #TUT073
OEM Part #TEST-3

TAP

- Use to re-tap door bellows housing bolt threads in door
- 3/8-19 BSPP threads
- Use a standard 9/16" open end wrench or a 5/8" socket as a hand tap wrench
- Fits:** Door
- Models:** EZ9, EZ9k, EZ10, EZ10k, ValueKlave (1730MKV), 1730E/EK/M/MK, 2340E/EA/EK/EKA/M/MK, 2540E/EA/EHS/EK/EKA/M/MK, 3850E/EA/EHS/M & 3870E/EA/EHS/M

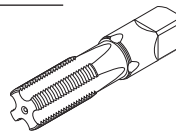

RPI Part #TUS014
OEM Part #01910190

DOOR SWITCH

- Momentary switch
- 15A @ 125-250VAC
- Includes: Mounting hardware
- 1/4" Tabs

Fits: Front Panel

- Models:** EZ9, EZ9k, EZ10, EZ10k, ValueKlave (1730MKV), 1730E/EK/M/MK, 2340E/EA/EK/EKA/M/MK, 2540E/EA/EHS/EK/EKA/M/MK, 3850E/EA/EHS/M & 3870E/EA/EHS/M

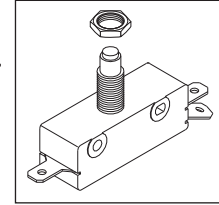

RPI Part #TUB072
OEM Part # (No OEM Part # Available)

RUBBER BOOT FOR DOOR SWITCH

- 3/8-32 thread (replaces mounting nut)
- Material: Clear silicone rubber
- Boot protects Door Switch from moisture
- Fits:** Door Switch

- Models:** EZ9, EZ9k, EZ10, EZ10k, ValueKlave (1730MKV), 1730E/EK/M/MK, 2340E/EA/EK/EKA/M/MK, 2540E/EA/EHS/EK/EKA/M/MK, 3850E/EA/EHS/M & 3870E/EA/EHS/M

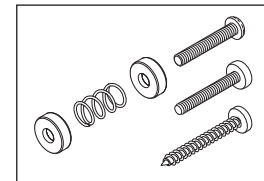

RPI Part #TUA066
OEM Part #CC312036 & CT312036

DOOR SWITCH ACTUATOR

- This kit now fits all Tuttnauer models
- Use to adjust door switch activation
- Includes all parts as shown
- Fits:** Door
- Models:** EZ9, EZ9k, EZ10, EZ10k, ValueKlave (1730MKV), 1730E/EK/M/MK, 2340E/EA/EK/EKA/M/MK, 2540E/EA/EHS/EK/EKA/M/MK, 3850E/EA/EHS/M & 3870E/EA/EHS/M

RPI Part #TUS146
OEM Part #SHIM

DOOR SHIM

- Used behind the door gasket
- Material: Stainless steel
- Also available: Door Gasket (RPI Part #TUG074)
- Fits:** Door Groove
- Models:** 3850E/EA/EHS/M & 3870E/EA/EHS/M



Table Top Sterilizers

Models: EZ9, EZ9k, EZ10, EZ10k, ValueKlave (1730MKV)™, 1730, 2340, 2540, 3850 & 3870 Series

RPI Part #TUC075
OEM Part # (No OEM Part # Available)

RESERVOIR COVER WITH DIPSTICK

- Includes all parts as shown
- Color: Light gray
- Fits:** Water Reservoir
- Models:** EZ9, EZ9k, EZ10, EZ10k, ValueKlave (1730MKV), 1730E/EK/M/MK, 2340E/EA/EK/EKA/M/MK, 2540E/EA/EHS/EK/EKA/M/MK, 3850E/EA/EHS/M & 3870E/EA/EHS/M

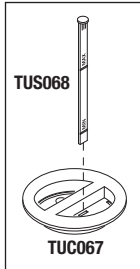

RPI Part #TUS068
OEM Part #02550043

WATER RESERVOIR DIPSTICK

- Color: Light gray
- Fits:** Water Reservoir Cover
- Models:** EZ9, EZ9k, EZ10, EZ10k, ValueKlave (1730MKV), 1730E/EK/M/MK, 2340E/EA/EK/EKA/M/MK, 2540E/EA/EHS/EK/EKA/M/MK, 3850E/EA/EHS/M & 3870E/EA/EHS/M



RPI Part #TUC067
OEM Part #02550019

WATER RESERVOIR/FILTER COVER

- Color: Light gray
- Fits:** Depending on the model, this unit fits the Water Reservoir or the opening that houses the air compressor filter
- Models:** EZ9, EZ9k, EZ10, EZ10k, ValueKlave (1730MKV), 1730E/EK/M/MK, 2340E/EA/EK/EKA/M/MK, 2540E/EA/EHS/EK/EKA/M/MK, 3850E/EA/EHS/M & 3870E/EA/EHS/M



RPI Part #TUG022
OEM Part #02610029

WATER RESERVOIR GASKET

- 6" round bellows style;
- Material: Black silicone
- Fits:** Water Reservoir
- Models:** EZ9, EZ9k, EZ10, EZ10k, ValueKlave (1730MKV), 1730E/EK/M/MK, 2340E/EA/EK/EKA/M/MK, 2540E/EA/EHS/EK/EKA/M/MK, 3850E/EA/EHS/M & 3870E/EA/EHS/M



RPI Part #TUS088
OEM Part #01630302

WATER LEVEL SWITCH

- Includes all parts as shown
- Horizontal mount
- Fits:** Water Reservoir
- Models:** EZ9, EZ9k, EZ10, EZ10k, 1730E/EK, 2340E/EA/EK/EKA, 2540E/EA/EK/EKA, 3850E/EA & 3870E/EA

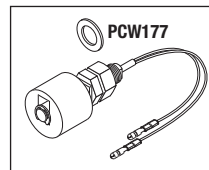

RPI Part #TUF058
OEM Part # 04010001/04010002

LEVELING FOOT

- 2 per package
- M10 threaded stud; 40mm dia. pad
- Material: Stainless steel stem with black Nylon pad
- Replaces the short stem foot (OEM #04010001) and long stem foot (OEM #04010002)
- Also available: Wrench (Low Profile) (RPI Part #RXT003)
- Fits:** Front of machine
- Model:** EZ9, EZ9k, EZ10, EZ10k, ValueKlave (1730MKV), 1730E/EK/M/MK, 2340E/EA/EK/EKA/M/MK, 2540E/EA/EHS/EK/EKA/M/MK, 3850E/EA/EHS/M & 3870E/EA/EHS/M

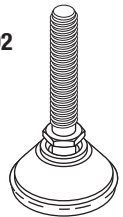

RPI Part #MIF062
OEM Part # (No OEM Part # Available)

FILL/VENT MESH CHAMBER FILTER

- 2 per package
- Can be used to filter chamber debris at fill and vent ports
- Material: 30 x 30 mesh (stainless steel)
- Fits:** Chamber ports
- Models:** EZ9, EZ9k, EZ10, EZ10k, ValueKlave (1730MKV), 1730E/EK/M/MK, 2340E/EA/EK/EKA/M/MK, 2540E/EA/EHS/EK/EKA/M/MK, 3850E/EA/EHS/M & 3870E/EA/EHS/M

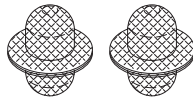

RPI Part #RPF644
OEM Part #03140036

HEPA FILTER

- 0.30 Micron
- Size: 2.57" dia. x 1.93" lg.
- Accommodates tubing with I.D. of 1/4" - 3/8"
- For use with air or gasses only
- Includes all parts as shown
- Fits:** Water Reservoir/Filter Cover
- Models:** EZ9, EZ9k, EZ10, EZ10k, 2340EA/EKA, 2540EA/EHS/EKA, 3850EA/EHS & 3870EA/EHS

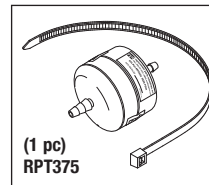

RPI Part #TUF103
OEM Part #FIL175-0006

FILTER SCREEN (New Style)

- Size: .70" dia. x 1.26" lg. mesh
- Material: Stainless steel
- Fits:** Filter Cap Assembly
- Models:** EZ9, EZ9k, EZ10, EZ10k, 1730E/EK, 2340E/EA/EK/EKA, 2540E/EA/EK/EKA 3850E/EA & 3870E/EA

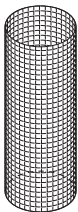

RPI Part #TUC040
OEM Part #CU836101

CONDENSATION COIL

- Material: 1/4" Copper
- Includes all parts as shown
- Models:** ValueKlave (1730MKV) & 1730E/EK/M/MK

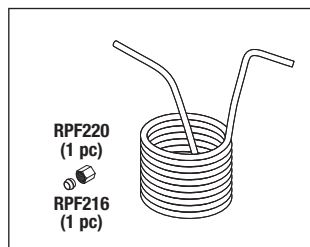

RPI Part #TUC145
OEM Part #CMT387-0029 & CC836101

CONDENSATION COIL

- Material: 1/4" Copper
- Includes all parts as shown
- Fits:** Water Reservoir
- Models:** 3850E/EA/M & 3870E/EA/M

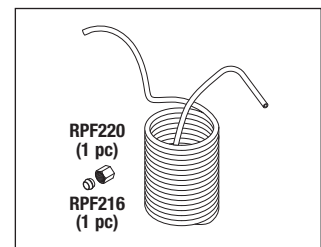

RPI Part #TUC041
OEM Part #CT836101 (Before 1993)

CONDENSATION COIL

- Material: 1/4" Copper
- Includes all parts as shown
- See **NOTE** below
- Models:** Only fits units before 1993: 2340E/EA/EK/EKA/M/MK & 2540E/EA/EK/EKA/M/MK

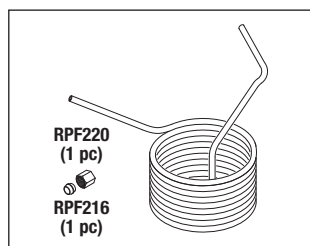

RPI Part #TUC063
OEM Part #CT836101 (After 1993)

CONDENSATION COIL

- Material: 1/4" Copper
- Includes all parts as shown
- See **NOTE** below
- Models:** Only fits units after 1993 (newer units): EZ9, EZ9k, EZ10, EZ10k, 2340E/EA/EK/EKA/M/MK & 2540E/EA/EK/EKA/M/MK

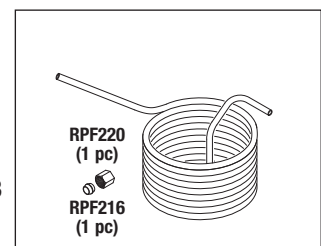

NOTE: Order RPI Part #TUC041 if the Coil joins reservoir at the left rear and vents towards the front of the machine.
 Order RPI Part #TUC063 if the Coil joins reservoir at the left front and vents towards the rear of the machine.

FAX: (818) 882-7028 • E-MAIL: order@rpiarts.com • WEBSITE: www.rpiarts.com

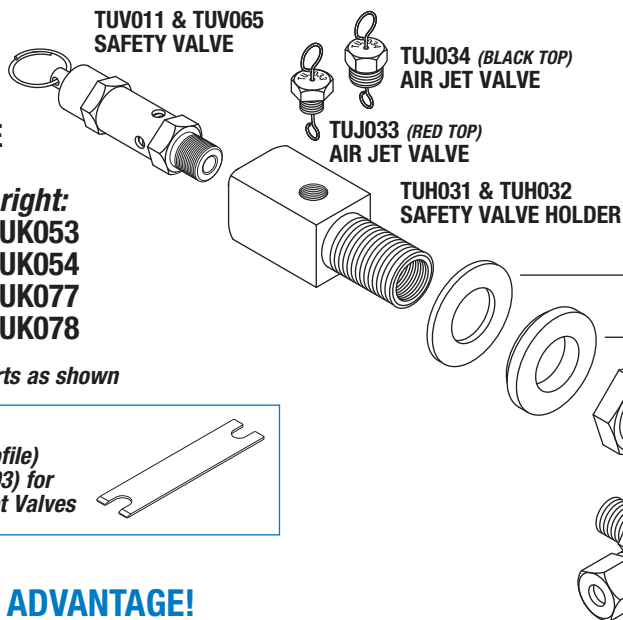

SERVICE TIP: When a Safety Valve needs replacement, replace it with the same rated PSI Valve – in other words, replace a 37 PSI Valve with a 37 PSI Valve, and a 40 with a 40. The PSI cracking pressure is actually etched onto the body of the valve for your reference.

SAFETY VALVE HOLDER KITS

- Shown to the right:**
- RPI PART #TUK053
 - RPI PART #TUK054
 - RPI PART #TUK077
 - RPI PART #TUK078

Kits include all parts as shown

Also available:
Wrench (Low Profile)
(RPI Part #RXT003) for
use on the Air Jet Valves

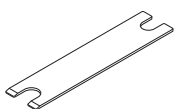

THE RPI ADVANTAGE! Safety Valve & Kits

- Safety Valve now available for 37 PSI and 40 PSI !
- Updated Safety Valve Kits include both the Elbow Fitting and Threaded Adapter for easy plumbing !

DESCRIPTION & PART #	EZ9/EZ10 1730E/M, 2340E/EA/M & 2540E/EA/EHS/M		3850E/EA/M & 3870E/EA/M		EZ9k, EZ10k, 1730EK/MK/MKV, 2340EK/EKA/MK, & 2540EK/EKA/MK		3850EHS & 3870EHS	
	40 PSI	37 PSI	40 PSI	40 PSI	37 PSI	40 PSI		
AIR JET VALVE (10 mm hex) RPI Part # TUJ033 (OEM PART #CB842010) RPI Part # TUJ034 (OEM PART #CT842010)	TUJ034 Black Top	TUJ033 Red Top	TUJ033 Red Top	TUJ033 Red Top	TUJ034 Black Top	TUJ034 Black Top		
SAFETY VALVE HOLDER KIT RPI Part #'s TUK053/TUK054/TUK077/TUK078 OEM PART #'s (No OEM Part #'s Available) • Includes Air Jet Valve, Safety Valve & Safety Valve Holder (see below)	TUK078	TUK053	TUK077	TUK077	TUK054	TUK078		
SAFETY VALVE HOLDER RPI Part #TUH031 (OEM PART #CT841010) RPI Part #TUH032 (OEM PART #CT841020) • Includes Safety Valve Holder, Threaded Adapter, Elbow Fitting & Hardware	TUH032	TUH031	TUH031	TUH031	TUH032	TUH032		
SAFETY VALVE (1/4" MPT) RPI Part # TUV011 (OEM PART #03110003) RPI Part # TUV065 (OEM PART #03110002)	TUV065	TUV011	TUV065	TUV065	TUV011	TUV065		
THREADED ADAPTER RPI Part #TUA060 OEM PART # (No OEM Part #'s Available)	TUA060	TUA060	TUA060	TUA060	TUA060	TUA060		
ELBOW FITTING RPI Part #TUF079 OEM PART # (No OEM Part #'s Available)	TUF079	TUF079	TUF079	TUF079	TUF079	TUF079		
MOUNTING HARDWARE (FOR SAFETY VALVE HOLDER) RPI Part #TUK055 OEM PART # (No OEM Part #'s Available) • Includes Flat Washer, Shoulder Washer and Nut	TUK055	TUK055	TUK055	TUK055	TUK055	TUK055		

RPI Part #RPT579
OEM Part # (No OEM Part # Available)

1/4" TEFLON THREAD SEALING TAPE

- 5 per package
- 1/4" x 260" per unit



RPI Part #RPT580
OEM Part # (No OEM Part # Available)

1/2" TEFLON THREAD SEALING TAPE

- 5 per package
- 1/2" x 260" per unit



RPI Part #RPA369
OEM Part # (No OEM Part # Available)

THREADLOCKER 545

- 5 per package; .02 fl. oz. per unit
- Temperature range of -65°F to 300°F (-54°C to 149°C)
- Seals operating pressures up to 10,000 PSI; For use on all pneumatic fittings



RPI Part #RPA459
OEM Part # (No OEM Part # Available)

PIPE SEALANT 567

- .20 fl. oz. (6 ml) per unit
- Temperature range: -65°F to 400°F (-54° to 204°C)
- MSDS and Technical Data Sheet available on website

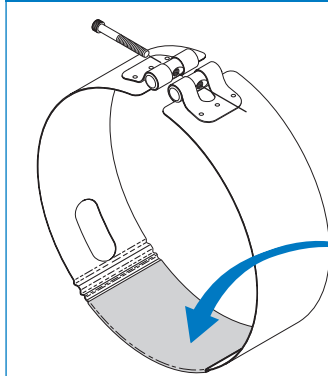

Table Top Sterilizers

Models: EZ9, EZ9k, EZ10, EZ10k, ValueKlave (1730MKV)™, 1730, 2340, 2540, 3850 & 3870 Series

HEATING ELEMENTS & HARDWARE

"BARREL" CLAMP STYLE



Stainless Steel Mounting Strap with Copper Heater Sheath!

Includes Heater Hardware (RPI Part #TUH052)

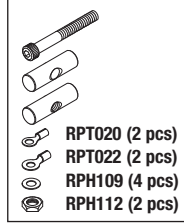

RPI Part #	OEM Part #	Description	Chamber Diameter	Fits Model(s)
HEATER ELEMENTS				
TUH027	01720001	Heater Element • 350W, 120V (41Ω)	7"	Fits only 120VAC units: 1730E/M
TUH004	01720011	Heater Element • 450W, 120V (32Ω)	7"	Fits only 120VAC units: ValueKlave (1730MKV) & 1730E/EK/M/MK
TUH016	01720012	Heater Element • 450W, 230V (117Ω)	7"	Fits only 230VAC units: ValueKlave (1730MKV) & 1730E/EK/M/MK
TUH005	01720002	Heater Element • 350W, 120V (41Ω)	9"	Fits only 120VAC units: EZ9 & 2340E/EA/M
TUH017	01720013	Heater Element • 550W, 230V (96Ω)	9"	Fits only 230VAC units: EZ9, EZ9k & 2340E/EA/EK/EKA/M/MK
TUH006	01720003	Heater Element • 350W, 120V (41Ω)	10"	Fits only 120VAC units: EZ10 & 2540E/EA/M
TUH018	01720014	Heater Element • 550W, 230V (96Ω)	10"	Fits only 230VAC units: EZ10, EZ10k & 2540E/EA/EK/EKA/M/MK
TUH147	HEA009-0008	Heating Element • 500W, 230V (105Ω)	16"	Fits only 230VAC units: 3870E/EA/M
TUH148	HEA009-0007	Heating Element • 600W, 230V (88Ω)	16"	Fits only 230VAC units: 3850E/EA/M

RPI Part #TUH052
OEM Part # (No OEM Part # Available)

HEATER HARDWARE

- Stainless steel
- Included with all RPI Heater Elements listed above

Fits: Barrel Style Mounting Systems

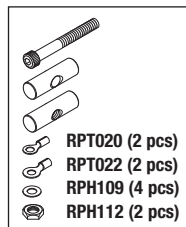

Fits

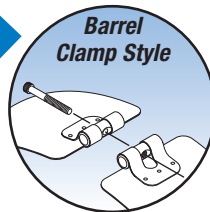

Also Available ...

RPI Part #TUH015
OEM Part # (No OEM Part # Available)

ATTACHING HARDWARE

- Stainless steel
- Fits:** Flange Style Mounting Systems

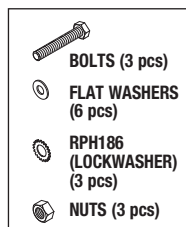

Fits

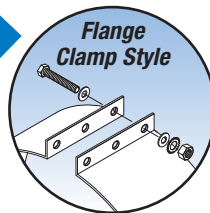

RPI Part #TUT155
OEM Part #THE005-0012

OVERTEMP THERMOSTAT

- Automatic reset
- Opens at 150°C (302°F), Closes at 115°C (115°F)
- 15A @120VAC; 10A @ 220VAC; 1/4" Tabs

Fits: Between Heating Element and Chamber
Models: ValueKlave (1730MKV) & 1730M/MK

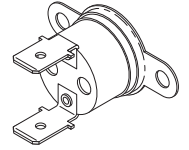

RPI Part #TUT038
OEM Part #01620004

SAFETY THERMOSTAT (MANUAL RESET)

- Preset 450°F (230°C)
- Stainless steel bulb and capillary tube

• Includes mounting hardware
Fits: Mounting Bracket in Rear of Machine

Models: EZ9, EZ9k, EZ10, EZ10k, ValueKlave (1730MKV), 1730E/EK/M/MK, 2340E/EA/EK/EKA/M/MK, 540E/EA/EK/EKA/M/MK, 3850E/EA/M & 3870E/EA/M

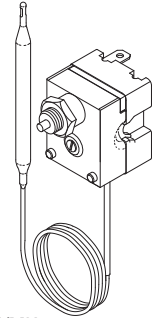

RPI Part #TUS035
OEM Part #01620301

OVER TEMPERATURE SAFETY SWITCH

- Opens @ 374°F (190°C); Closes @ 350°F (177°C)
- Factory calibrated
- Includes all parts as shown
- Fits only units prior to 1993

Fits: Heater Band

Models: 1730EK/MK, 2340EK/MK & 2540EK/MK

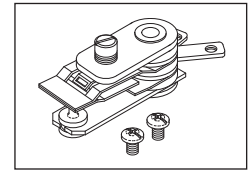

IMPORTANT NOTE
Only fits units prior to 1993

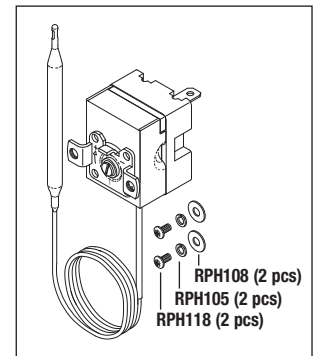

RPI Part #TUT039
OEM Part #01620103

SAFETY THERMOSTAT (AUTOMATIC RESET)

- Preset 360°F (180°C)
- Stainless steel bulb and capillary tube
- Includes mounting hardware

Fits: Mounting bracket in Rear of Machine

Models: EZ9, EZ9k, EZ10, EZ10k, ValueKlave (1730MKV), 1730E/EK/M/MK, 2340E/EA/EK/EKA/M/MK, 2540E/EA/EK/EKA/M/MK, 3850E/EA/M & 3870E/EA/M

RPI Part #TUG012
OEM Part #02300011

PRESSURE GAUGE WITH INDICATOR

- 2-1/2" dia.; Dial reads: 0-60 PSIG (0-307°F)
 - Port: 1/2-19 BSPP center back mount / 3/16" compression fitting
 - Max. indicator pointer resettable
 - Includes: Mounting bracket and hardware
- Fits:** Front Panel
Models: ValueKlave (1730MKV), 1730M/MK, 2340M/MK, 2540M/MK, 3850M & 3870M

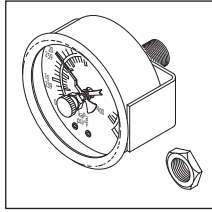

RPI Part #TUG020
OEM Part #02300012

PRESSURE GAUGE

- 1-1/2" dia.; Dial reads: 0-500 kPa abs.; -30" Hg to +60 PSI
 - Port: 1/8-28 BSPP center back mount / 3/16" compression fitting
 - Includes: Mounting bracket and hardware
- Fits:** Door or Front Panel
Models: ValueKlave (1730MKV), 1730MK, 2540EHS, 3850EHS & 3870EHS

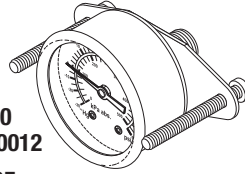

RPI Part #TUS009
OEM Part #01910172

POWER SWITCH

- Rocker switch (On-Off), Legend: I/O; Green lens
 - 16A @ 125-250VAC; DPST; 1/4" Tabs
 - Panel cutout: 1.185" x .874"
- Fits:** Front Panel Cut-Out
Models: EZ9, EZ9k, EZ10, EZ10k, ValueKlave (1730MKV), 1730E/EK/M/MK, 2340E/EA/EK/EKA/M/MK, 2540E/EA/EK/EKA/M/MK, 3850E/EA/M & 3870E/EA/M

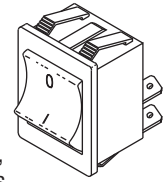

RPI Part #TUL136
OEM Part #01910261

SIGNAL LIGHT (AMBER 220V)

- 250VAC; Neon
 - 8" lg. #22 AWG wires; 5/16" dia. mounting hole
- Fits:** Front Panel
Models: Only fits the 230VAC units: ValueKlave (1730MKV), 1730M/MK, 2340M/MK, 2540M/MK, 3850M & 3870M

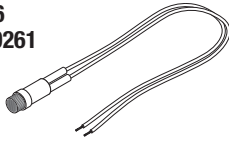

RPI Part #TUL137
OEM Part #01919262

SIGNAL LIGHT (GREEN 220V)

- 250VAC; Neon
 - 8" lg. #22 AWG wires; 5/16" dia. mounting hole
- Fits:** Front Panel
Models: Only fits the 230VAC units: ValueKlave (1730MKV), 1730M/MK, 2340M/MK, 2540M/MK, 3850M & 3870M

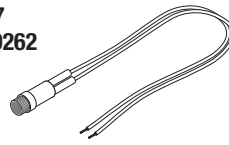

RPI Part #MDL021
OEM Part #01910257

SIGNAL LIGHT (AMBER 125V)

- 125VAC; Neon
 - 18" lg. wires with 1/4" quick disconnect terminals; 5/16" dia. mounting hole
 - Includes (1) speed nut
- Fits:** Control Panel
Models: Only fits the 120VAC units: ValueKlave (1730MKV), 1730M/MK, 2340M & 2540M

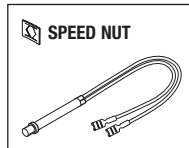

RPI Part #MDL022
OEM Part #01910258

SIGNAL LIGHT (GREEN 125V)

- 125VAC; Neon
 - 18" lg. wires with 1/4" quick disconnect terminals; 5/16" dia. mounting hole
 - Includes (1) speed nut
- Fits:** Control Panel
Models: Only fits the 120VAC units: ValueKlave (1730MKV), 1730M/MK, 2340M & 2540M

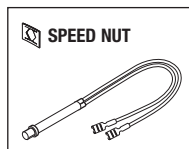

RPI Part #TUB048
OEM Part #01910099

CIRCUIT BREAKER (7A)

- 7 AMPS; 1/4" Tabs
 - Includes all parts as shown
- Models:** Only fits the 230VAC units: ValueKlave (1730MKV) & 1730E/EK/MK

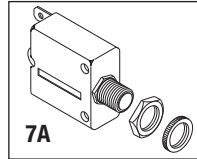

RPI Part #TUB047
OEM Part #01910100

CIRCUIT BREAKER (15A)

- 15 AMPS; 1/4" Tabs
 - Includes all parts as shown
- Models:** ValueKlave (1730MKV), 1730M/MK, 2340M/MK & 2540M/MK

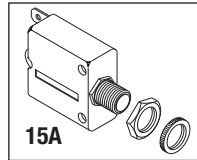

RPI Part #TUB023
OEM Part #01910098

CIRCUIT BREAKER (15A)

- 15 AMPS; 1/4" Tabs
- Fits:** Rear Panel
Models: EZ9, EZ9k, EZ10, EZ10k, ValueKlave (1730MKV), 1730E/EK/M/MK, 2340E/EA/EK/EKA/M/MK, 2540E/EA/EK/EKA/M/MK, 3850E/EA/M & 3870E/EA/M

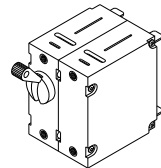

RPI Part #TUB024
OEM Part #01910097

CIRCUIT BREAKER (10A)

- 10 AMPS; 1/4" Tabs
- Fits:** Rear Panel
Models: EZ9, EZ9k, EZ10, EZ10k, 1730E/EK, 2340E/EA/EK/EKA, 2540E/EA/EK/EKA, 3850E/EA & 3870E/EA

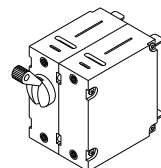

RPI Part #RPR583
OEM Part #02819993

AC INLET RECEPTACLE

- 15A @ 250VAC; 1/4" Tabs
- Fits:** Receptacles
Models: EZ9, EZ9k, EZ10, EZ10k, ValueKlave (1730MKV), 1730E/EK/M/MK, 2340E/EA/EK/EKA/M/MK, 2540E/EA/EHS/EK/EKA/M/MK, 3850E/EA/EHS/M & 3870E/EA/EHS/M

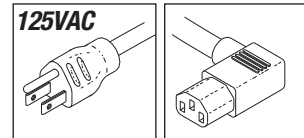
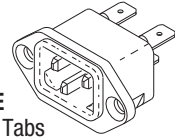

RPI Part #TUC028
OEM Part #02819995

POWER CORD

- 14/3 SJT; 105°C; 15A @ 125VAC
 - Plug Type: NEMA 5-15P; 10' lg.
 - Connector Type: EN60320-C13R Right Angle
- Fits:** Power Entry Module
Models: Only fits the 120VAC units: EZ9, EZ10, ValueKlave (1730MKV), 1730E/EK/M/MK, 2340E/EA/M & 2540E/EA/EHS/M

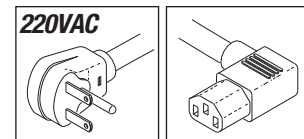

RPI Part #RPC582
OEM Part #02819996

POWER CORD

- 14/3 SJT; 105°C; 15A @ 220VAC
 - Plug Type: NEMA 6-15P; 12' lg.
 - Connector Type: EN60320-C13R Right Angle
- Fits:** AC Inlet Receptacle
Models: Only fits the 230VAC units: EZ9, EZ9k, EZ10, EZ10k, ValueKlave (1730MKV), 1730E/EK/M/MK, 2340E/EA/EK/EKA/M/MK, 2540E/EA/EHS/EK/EKA/M/MK, 3850E/EA/EHS/M & 3870E/EA/EHS/M

Table Top Sterilizers

Models: EZ9, EZ9k, EZ10, EZ10k, ValueKlave (1730MKV)™, 1730, 2340, 2540, 3850 & 3870 Series

RPI Part #TUT008
OEM Part #01910011 & 01910005

TIMER (60 MINUTE)

- 60 Minutes, Bell alert
- 16A @ 250VAC; SPST
- 1/4" Tabs
- Includes: Knob (RPI Part #TUK049) and mounting hardware

Fits: Front Panel

Models: ValueKlave (1730MKV), 1730M/MK, 2340M/MK, 2540M/MK, 3850M & 3870M

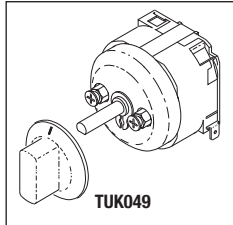

RPI Part #TUK049
OEM Part #02450002

TIMER & MULTI-PURPOSE VALVE KNOB

Fits: Front Panel Controls for Timer and Multi-Purpose Valve (1/4" dia. 'D' Flat Shaft)

Models: ValueKlave (1730MKV), 1730M/MK, 2340M/MK, 2540M/MK, 3850M & 3870M

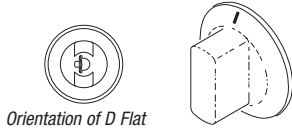

NOTE: Existing connections should accommodate most units manufactured after Jan, 1993. However some modifications may be necessary. Modification instructions are included with parts.

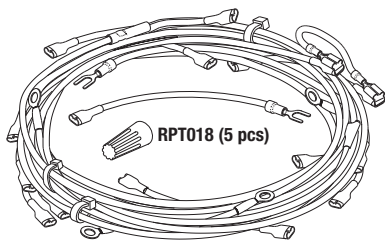

RPI Part #TUH043
OEM Part #CU900012

WIRE HARNESS

- Includes all parts as shown
- Models:** 1730M/MK

RPI Part #TUH044
OEM Part #CT900012

WIRE HARNESS

- Includes all parts as shown
- Models:** 2340M/MK & 2540M/MK

RPI Part #TUT007
OEM Part #01620101

CONTROL THERMOSTAT

- 30" copper capillary tube with 3/16" dia. x 5-1/2" lg. copper bulb; Operates from 0 to 32 PSIG
- This is a "Pressure Stat" type device. The bulb is open ended.
- Includes all parts as shown
- Does NOT include the stop plate
- Also available: Thermostat Stop Plate (RPI Part #TUP062)

Mounts: To Rear Steam Manifold Assembly

Models:

ValueKlave (1730MKV), 1730M/MK, 2340M/MK, 2540M/MK, 3850M & 3870M

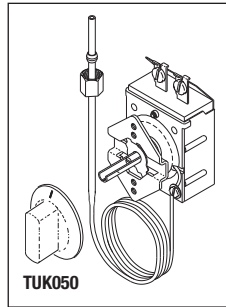

SERVICE TIP: Do Not through the original stop plate away! Safe it for reuse with the new Control Thermostat.

RPI Part #TUP062
OEM Part #CT910020

THERMOSTAT STOP PLATE

- Material: Stainless steel
- Designed to allow the control thermostat knob to start and stop within the scale printed on the front panel.
- Also available: Control Thermostat (RPI Part #TUT007)

Fits: Control Thermostat

Models: ValueKlave (1730MKV), 1730M/MK, 2340M/MK, 2540M/MK, 3850M & 3870M

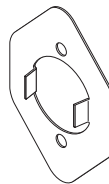

RPI Part #TUK050
OEM Part #02450003

THERMOSTAT KNOB

- Fits:** Thermostat (1/4" dia. 'D' Flat Shaft)
- Models:** ValueKlave (1730MKV), 1730M/MK, 2340M/MK, 2540M/MK, 3850M & 3870M

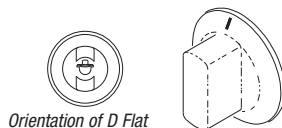

SERVICE TIP: If unit is to be upgraded from the old style Microswitches (Cherry E11- Grey or E13-Black) to the new style Microswitch (Cherry D48X-Grey or Red and Grey), then the Microswitch Kit (RPI Part #TUK061) must be used. The Kit includes the spacers and hardware that are necessary to upgrade from the old style to the new style Microswitches.

RPI Part #TUS013
OEM Part #01910191

MICROSWITCH (CHERRY E13/BLACK)

- 15A @ 125-250VAC; 1/4" Tabs
- Cherry E13 (Black)
- Old large style switch

Fits: Multi-Purpose Valve

Models: ValueKlave (1730MKV), 1730M/MK, 2340M/MK, 2540M/MK, 3850M & 3870M

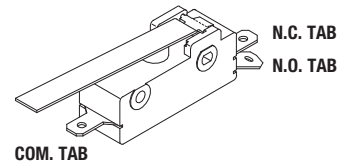

RPI Part #TUS057
OEM Part #ELE036-0012

MICROSWITCH

- 26A @ 125-250VAC; 1/4" Tabs
- New current small style switch
- Included in: Microswitch Kit (RPI Part #TUK061) and Multi-Purpose Valve (RPI Part #'s TUV025, TUV097 & TUV098)

Fits: Multi-Purpose Valve

Models: ValueKlave (1730MKV), 1730M/MK, 2340M/MK, 2540M/MK, 3850M & 3870M

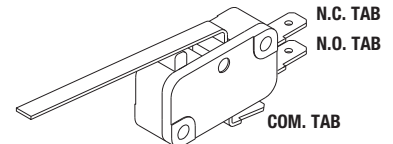

RPI Part #TUK061
OEM Part #01910197

MICROSWITCH KIT

- Includes all parts as shown
- Included in: Multi-Purpose Valve (RPI Part #'s TUV025, TUV097 & TUV098)

Fits: Multi-Purpose Valve

Models: ValueKlave (1730MKV), 1730M/MK, 2340M/MK, 2540M/MK, 3850M & 3870M

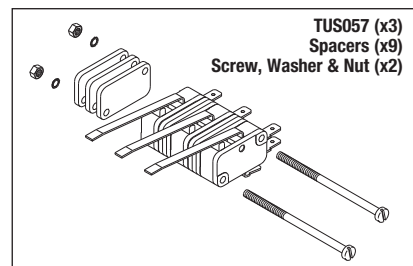

THE RPI ADVANTAGE!
Now you have a choice.
Replace the entire Valve or repair
it with the RPI Valve Repair Kit!

IMPORTANT NOTE REGARDING THE MULTI-PURPOSE VALVE & VALVE REPAIR KITS THAT FIT THE VALUEKLAVE (1730MKV)

The Multi-Purpose Valves and Valve Repair Kits shown below fit only those sterilizers where the Valve is installed on the right side of the machine. The **length of the shaft** (short or long) as well as the **direction of the pipe fittings** will determine which of the Valves or Valve Repair Kits is needed.

ValueKlave 1730MKV, 1730, 2340, 2540, 3850 & 3870 Series

Long Shaft

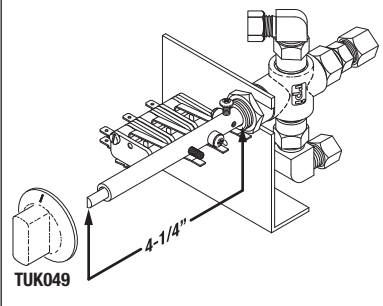

RPI Part #TUV025
OEM Part #CT810013

MULTI-PURPOSE VALVE

- See **IMPORTANT NOTE** above
- Valve includes **Long** Shaft Assembly
- Includes: Valve Assembly, New Style Microswitch (Cherry D48X/Grey) (RPI Part #TUS057) and Knob (RPI Part #TUK049)
- Also available: Repair Kit (MPV) (RPI Part #TUK037) and Microswitch Kit (RPI Part #TUK061)

Fits: Front Panel, Right Side of Machine with Square Door

Model: ValueKlave (1730MKV), 1730M/MK, 2340M/MK, 2540M/MK, 3850M & 3870M

Long Shaft

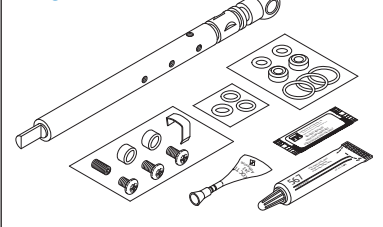

RPI Part #TUK037
OEM Part # (No OEM Part # Available)

REPAIR KIT (MPV)

- See **IMPORTANT NOTE** above
- Use this Kit to repair Multi-Purpose Valve Assemblies with the **Long** shaft
- Includes all parts as shown

Fits: Front Panel, Right Side of Machine

Model: ValueKlave (1730MKV), 1730M/MK, 2340M/MK, 2540M/MK, 3850M & 3870M

ValueKlave 1730MKV

Long Shaft

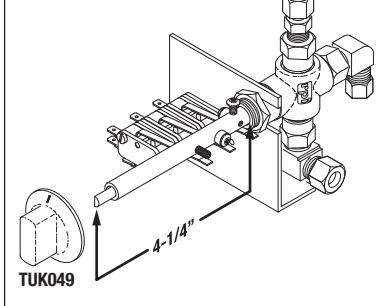

RPI Part #TUV097
OEM Part #CMT173-0031

MULTI-PURPOSE VALVE

- See **IMPORTANT NOTE** above
- Valve includes **Long** Shaft Assembly
- Includes: Valve Assembly, New Style Microswitch (Cherry D48X/Grey) (RPI Part #TUS057) and Knob (RPI Part #TUK049)
- Also available: Repair Kit (MPV) (RPI Part #TUK037) and Microswitch Kit (RPI Part #TUK061)

Fits: Front Panel, Right Side of Machine with Square Door

Model: ValueKlave (1730MKV)

Long Shaft

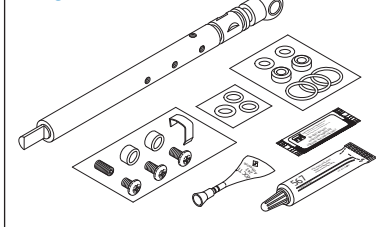

RPI Part #TUK037
OEM Part # (No OEM Part # Available)

REPAIR KIT (MPV)

- See **IMPORTANT NOTE** above
- Use this Kit to repair Multi-Purpose Valve Assemblies with the **Long** shaft
- Includes all parts as shown

Fits: Front Panel, Right Side of Machine

Model: ValueKlave (1730MKV)

ValueKlave 1730MKV

Short Shaft

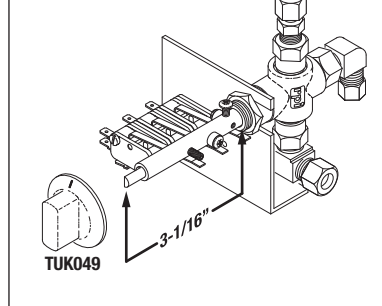

RPI Part #TUV098
OEM Part #CMT173-0031

MULTI-PURPOSE VALVE

- See **IMPORTANT NOTE** above
- Valve includes **Short** Shaft Assembly
- Includes: Valve Assembly, New Style Microswitch (Cherry D48X/Grey) (RPI Part #TUS057) and Knob (RPI Part #TUK049)
- Also available: Repair Kit (MPV) (RPI Part #TUK099) and Microswitch Kit (RPI Part #TUK061)

Fits: Front Panel, Right Side of Machine with Round Door

Model: ValueKlave (1730MKV)

Short Shaft

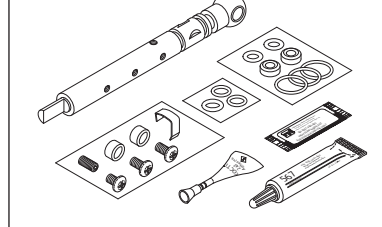

RPI Part #TUK099
OEM Part # (No OEM Part # Available)

REPAIR KIT (MPV)

- See **IMPORTANT NOTE** above
- Use this Kit to repair Multi-Purpose Valve Assemblies with the **Short** shaft
- Includes all parts as shown

Fits: Front Panel, Right Side of Machine

Model: ValueKlave (1730MKV)

Table Top Sterilizers

Models: EZ9, EZ9k, EZ10, EZ10k, ValueKlave (1730MKV)™, 1730, 2340, 2540, 3850 & 3870 Series



Diagnostic Smart Kit® For Servicing Tuttnauer® Automatic Autoclaves RPI Part #TUK108 (OEM Part #TEST-9)

- Calibrate/verify displayed pressure and temperature values.
- Check and monitor all test point values from the AJUNC or ANL boards.
- Plus, Kit includes a durable plastic case and a troubleshooting information booklet.

Model: EZ9, EZ9K, EZ10, EZ10k, 1730E/EK, 2340E/EA/EK/EKA, 2540E/EA/EK/EKA, 3850E/EA & 3870E/EA

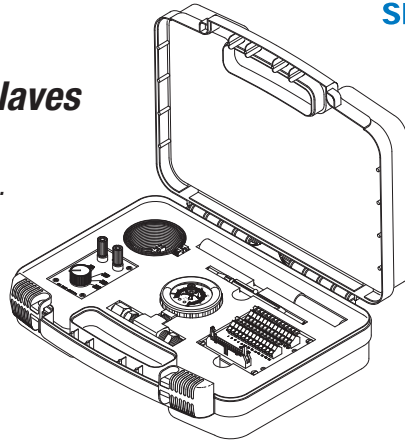

Kit includes all parts shown below!

RPI Part #TUT114 OEM Part #TEST-7

SIMULATOR (PT-100)

- For Temperature Sensor calibration (simulates high and low temperatures)
- Use with Wire Harness No. 1, 2, or 3 (RPI Part #TUH111, TUH112, or TUH113) depending on the model number.

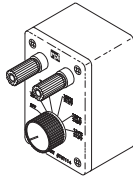

RPI Part #TUB109 OEM Part #TEST-1

TEST POINT BOARD

- Use with Ribbon Cable (RPI Part #TUC117)

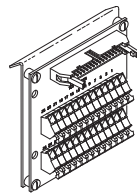

RPI Part #TUC117 OEM Part # (No OEM Part # Available)

RIBBON CABLE

- Use with Test Point Board (RPI Part #TUB109)



RPI Part #RPC476 OEM Part # (No OEM Part # Available)

CARRYING CASE

- Includes "Pick-n-Pluck" foam insert



RPI Part #TUH111 OEM Part # (No OEM Part # Available)

WIRE HARNESS (No. 1)

- Small-sized 2 Pin Connector without jumper
- Use with Simulator (PT-100) (RPI Part #TUT114)

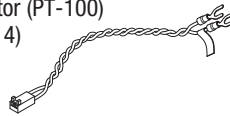

RPI Part #TUH112 OEM Part # (No OEM Part # Available)

WIRE HARNESS (No. 2)

- Medium-sized 2 Pin Connector without jumper
- Use with Simulator (PT-100) (RPI Part #TUT114)

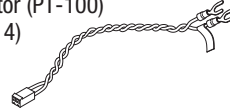

RPI Part #TUH113 OEM Part # (No OEM Part # Available)

WIRE HARNESS (No. 3)

- Large-sized 3 Pin Connector with jumper
- Use with Simulator (PT-100) (RPI Part #TUT114)

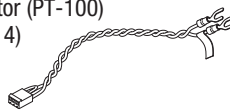

RPI Part #RPT460 OEM Part # (No OEM Part # Available)

TRIM POT ADJUSTMENT TOOL

- 5" Long; Plastic with stainless steel blades

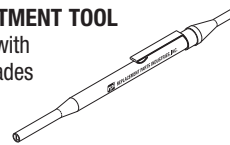

RPI Part #RPT113 OEM Part # (No OEM Part # Available)

MAX REGISTER THERMOMETER

- Use for temperature verification in sterilizers
- Dual Scale: 150°F to 350°F (65°C to 177°C)

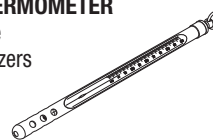

TUG110

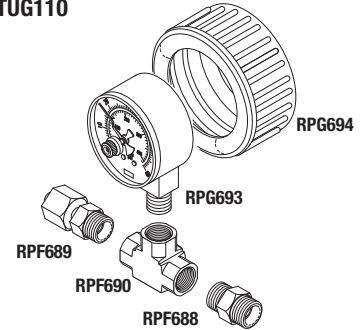

RPI Part #TUG110 OEM Part #TEST-2

PRESSURE GAUGE (TEST)

- Includes all parts as shown - see descriptions of parts below
- Fits:** Chamber manifold

RPI Part #RPG693

PRESSURE GAUGE

- Size: 2.5" dia.; 0-60 PSI/0-400 KPA scale
- Port: 1/4" MPT bottom mount
- Maximum indicating pointer for the highest PSI reading

RPI Part #RPG694

GAUGE GUARD

- Fits 2.50" dia. x 1" thk. gauge with lower or center back mount connections
- Soft rubber; Color: Blue

RPI Part #RPF688

MALE CONNECTOR (3/16" TUBE x 1/4" MPT)

- Material: Brass

RPI Part #RPF689

TUBE ADAPTER (3/16" TUBE x 1/4" MPT)

- Material: Brass

RPI Part #RPF690

TEE FITTING

- Material: Brass; Size: 1/4" x 1/4" x 1/4" FPT

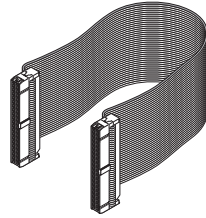

RPI Part #TUC144
OEM Part #02830105

RIBBON CABLE

- 40 pin (2 x 20) IDC connector with a 12" lg. cable
- Connects the Display Board (PREDG) with Blue LCD (RPI part #TUB161) or Display Board (PREDG) with Green LCD (RPI Part #TUB162) to the PCB AJUNC-3 (RPI Part #TUB154)

Models: EZ9, EZ9k, EZ10, EZ10k, 1730E/EK, 2340E/EA/EK/EKA, 2540E/EA/EK/EKA, 3850E/EA & 3870E/EA

SERVICE TIP: The PC Board (AJUNC 3) **MUST** be calibrated upon installation or whenever the Pressure Transducer or Temp Sensor (PT-100) is replace. All of the tools needed to calibrate the PC Board are included in the RPI Diagnostic Smart Kit® (RPI Part #TUK108) - See Page 10 -1709.

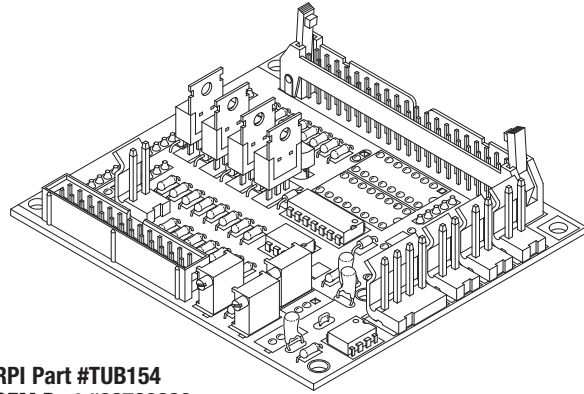

RPI Part #TUB154
OEM Part #03700029

PC BOARD (AJUNC-3)

- This board **MUST** be calibrated upon installation.
- Also available: Ribbon Cable (RPI Part #TUC144)

Fits: Electronics Bay

Models: EZ9, EZ9k, EZ10, EZ10k, 1730E/EK, 2340E/EA/EK/EKA, 2540E/EA/EK/EKA, 3850E/EA & 3870E/EA

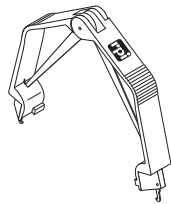

RPI Part #RPT962
OEM Part #
(No OEM Part # Available)

CHIP EXTRACTOR

- Specially designed tool for easy removal of PLCC type devices from their sockets
- Also available: Grounding Strap (RPI Part #RPS998)

Perfect for removing and installing the main processor chip for the display board!

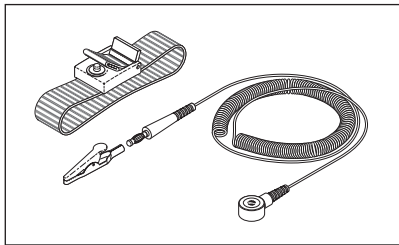

RPI Part #RPS998
OEM Part #
(No OEM Part # Available)

GROUNDING STRAP

- Specifically designed for grounding to an ESD work bench or a chassis to help reduce static discharge

Perfect for reducing static discharge when working on fragile electrical components!

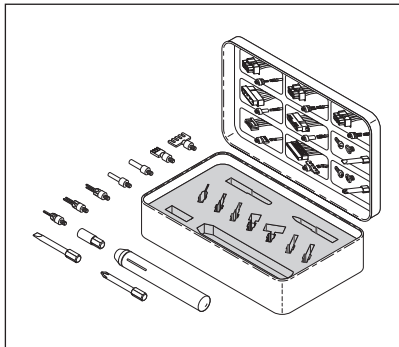

RPI Part #RPK961
OEM Part #
(No OEM Part # Available)

TERMINAL TOOL KIT

- Tools made specifically for easy removal of terminals from 4 and 8 pin EPS (12V), ATX, Molex, TE/Amp, JST and PCI-E connectors

Perfect for removing terminals from connectors!

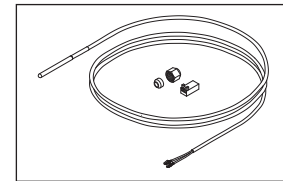

RPI Part #TUS093
OEM Part #01610501

TEMP SENSOR (PT-100)

- 100Ω @ 25°C
- Includes: PTFE Ferrule, Compression Nut (RPI Part #RPF220), two wire connector housing, and crimped contacts

Fits: Chamber Manifold, AJUNC 3 PCB at the J11 connector

Models: EZ9, EZ9k, EZ10, EZ10k, 1730E/EK, 2340E/EA/EK/EKA, 2540E/EA/EK/EKA, 3850E/EA & 3870E/EA

Our Pressure Transducer also includes the Pressure Tube Kit (RPI Part #RPK282) It's the RPI advantage!

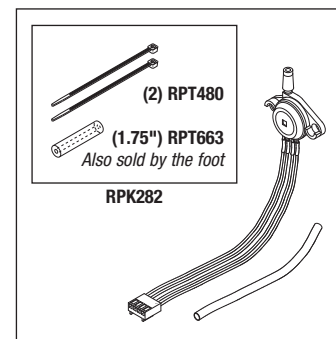

RPI Part #TUT092
OEM Part #
01630101 (AJUNC 2 PCB) & 01630101-1 (AJUNC 3 PCB)

PRESSURE TRANSDUCER

- Direct replacement for use with the AJUNC 3 PCB and also can be used to repair Pressure Transducer Assembly for the AJUNC 2 PCB
- Includes: Pressure Tube Kit (RPI Part #RPK282)

Fits: AJUNC 2 PCB & AJUNC 3 PCB

Models: EZ9, EZ9k, EZ10, EZ10k, 1730E/EK, 2340E/EA/EK/EKA, 2540E/EA/EK/EKA, 3850E/EA & 3870E/EA

Table Top Sterilizers

Models: EZ9, EZ9k, EZ10, EZ10k, ValueKlave (1730MKV)™, 1730, 2340, 2540, 3850 & 3870 Series

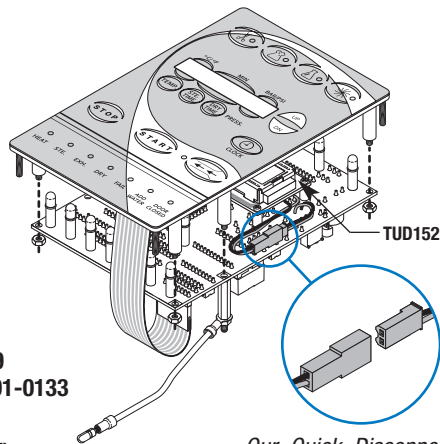

RPI Part #TUA159
OEM Part #CTP201-0133

LCD DISPLAY ASSEMBLY (BLUE)

- See **Important Note** below
- Includes all parts as shown
- Also available: Ribbon Cable (RPI Part #TUC144)

Fits: Front Panel

Models: EZ9, EZ9k, EZ10, EZ10k, 1730E/EK, 2340E/EA/EK/EKA, 2540E/EA/EK/EKA, 3850E/EA & 3870E/EA

Our Quick Disconnect wiring system makes for easy replacement of the LCD Display. It's the RPI advantage!

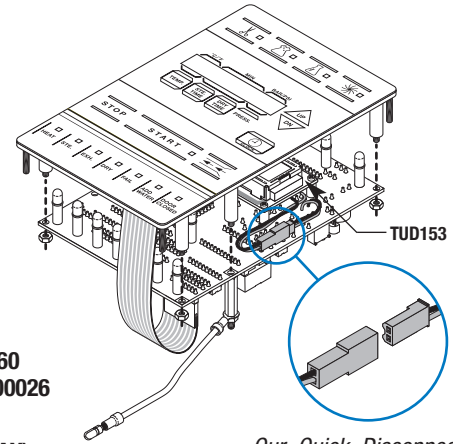

RPI Part #TUA160
OEM Part #03700026

LCD DISPLAY ASSEMBLY (GRAY)

- See **Important Note** below
- Includes all parts as shown
- Also available: Ribbon Cable (RPI Part #TUC144)

Fits: Front Panel

Models: EZ9, EZ9k, EZ10, EZ10k, 1730E/EK, 2340E/EA/EK/EKA, 2540E/EA/EK/EKA, 3850E/EA & 3870E/EA

Our Quick Disconnect wiring system makes for easy replacement of the LCD Display. It's the RPI advantage!

RPI Part #TUK150
OEM Part #03700027-1

KEYPAD (BLUE)

- Size: 6.50" x 4.00"
- Material: Keypad with aluminum backing panel

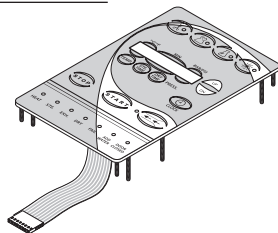

RPI Part #TUK151
OEM Part #3700027

KEYPAD (GRAY)

- Size: 6.50" x 4.00"
- Material: Keypad with aluminum backing panel

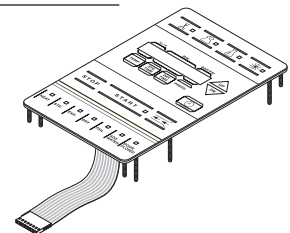

RPI Part #TUD152
OEM Part #CTP201-0168

LCD DISPLAY (BLUE)

- +5VDC, 16 character, single line
- Includes all parts as shown
- Fits:** Display Board (PREDG) with Blue LCD

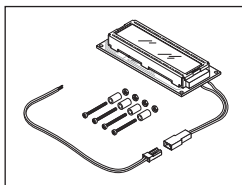

RPI Part #TUD153
OEM Part #4400317

LCD DISPLAY (GREEN)

- +5VDC, 16 character, single line
- Includes all parts as shown
- Fits:** Display Board (PREDG) with Green LCD

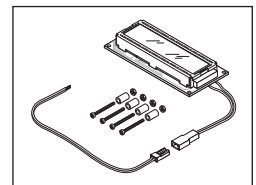

RPI Part #TUB161
OEM Part #CTP000-0133

DISPLAY BOARD (PREDG) WITH BLUE LCD

- See **Important Note** below
- Includes: LCD Display (Blue) (RPI Part #TUD152) and Clock Chip (With Battery) (RPI Part #TUC107)

Fits: Display Panel

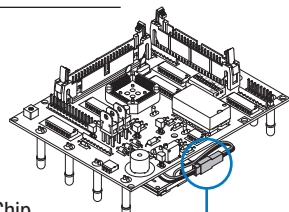

Quick Disconnect It's the RPI Advantage!

RPI Part #TUB162
OEM Part #03700024

DISPLAY BOARD (PREDG) WITH GREEN LCD

- See **Important Note** below
- Includes: LCD Display (Green) (RPI Part #TUD153) and Clock Chip (With Battery) (RPI Part #TUC107)

Fits: Display Panel

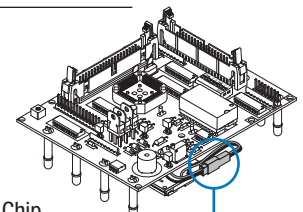

Quick Disconnect It's the RPI Advantage!

RPI Part #TUC107
OEM Part #0180202

CLOCK CHIP (WITH BATTERY)

- 24 PIN package
- Includes all parts as shown
- After the Clock Chip (With Battery) is installed, the machine must be reprogrammed

Fits: Display Board (PREDG) with Blue LCD & Display Board (PREDG) with Green LCD

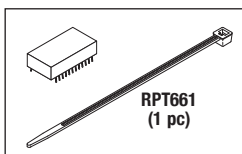

RPI Part #TUC107
OEM Part #0180202

CLOCK CHIP (WITH BATTERY)

- 24 PIN package
- Includes all parts as shown
- After the Clock Chip (With Battery) is installed, the machine must be reprogrammed

Fits: Display Board (PREDG) with Blue LCD & Display Board (PREDG) with Green LCD

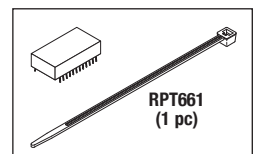

Important Note: These boards do not contain the main processor chip! It is recommended that you use a Chip Extractor (RPI Part #RPT962) and Grounding Strap (RPI Part #RPS998) to remove the processor chip from your old board to install on the new board.

FAX: (818) 882-7028 • E-MAIL: order@rpiparts.com • WEBSITE: www.rpiparts.com

RPI Part #TUV081
OEM Part #01810101

SOLENOID VALVE (3mm)

- 3mm orifice
- Ports: 1/4 FPT
- Material: Brass body, Viton® plunger seat
- Also available: Magnetic Coil (10W) (RPI Part #TUC083), Solenoid Valve Repair Kit (RPI Part #TUK082) and Wire Connector w/Gasket (RPI Part #TUC084)

Fits: Air Valve, Exhaust Valve and Air-Outlet Valve

Models: EZ9, EZ9k, EZ10, EZ10k, 1730E/EK, 2340E/EA/EK/EKA, 2540E/EA/EK/EKA, 3850E/EA & 3870E/EA

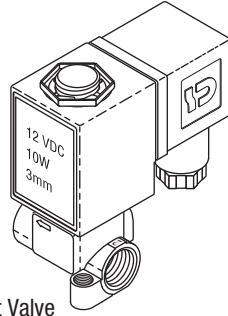

RPI Part #TUV085
OEM Part #01810103

SOLENOID VALVE (6mm)

- 6mm orifice
- Ports: 1/4 FPT
- Material: Brass body; EPDM plunger seat
- Includes: Magnetic Coil (12W) (RPI Part #TUC087), Solenoid Valve Repair Kit (RPI Part #TUK086) and Wire Connector w/Gasket (RPI Part #TUC084)

Fits: Fill Valve

Models: EZ9, EZ9k, EZ10, EZ10k, 1730E/EK, 2340E/EA/EK/EKA, 2540E/EA/EK/EKA, 3850E/EA & 3870E/EA

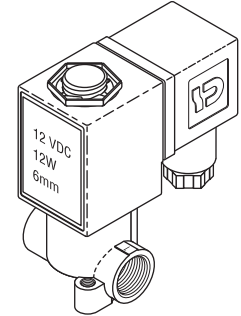

RPI Part #TUK082
OEM Part #01810903

SOLENOID VALVE REPAIR KIT (3mm)

- Repair kit for 3mm orifice Solenoid Valve
- Viton® plunger seat
- Includes all parts as shown

Fits: Air Valve, Exhaust Valve and Air-Outlet Valve

Models: EZ9, EZ9k, EZ10, EZ10k, 1730E/EK, 2340E/EA/EK/EKA, 2540E/EA/EK/EKA, 3850E/EA & 3870E/EA

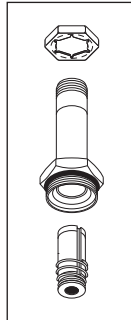

RPI Part #TUK086
OEM Part #01810904

SOLENOID VALVE REPAIR KIT (6mm)

- Repair kit for 6mm orifice Solenoid Valve
- EPDM plunger seat
- Includes all parts as shown

Fits: Fill Valve

Models: EZ9, EZ9k, EZ10, EZ10k, 1730E/EK, 2340E/EA/EK/EKA, 2540E/EA/EK/EKA, 3850E/EA & 3870E/EA

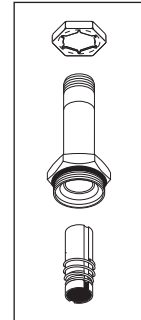

RPI Part #TUC083
OEM Part #01810102

MAGNETIC COIL (10W)

- 12VDC; 10W

Fits: Air Valve, Exhaust Valve and Air-Outlet Valve

Models: EZ9, EZ9k, EZ10, EZ10k, 1730E/EK, 2340E/EA/EK/EKA, 2540E/EA/EK/EKA, 3850E/EA & 3870E/EA

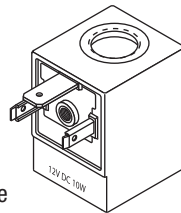

RPI Part #TUC087
OEM Part #01810905

MAGNETIC COIL (12W)

- 12VDC; 12W

Fits: Fill Valve

Models: EZ9, EZ9k, EZ10, EZ10k, 1730E/EK, 2340E/EA/EK/EKA, 2540E/EA/EK/EKA, 3850E/EA & 3870E/EA

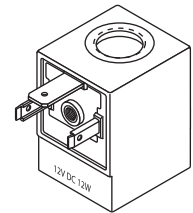

RPI Part #TUC084
OEM Part #01810909/01810910

WIRE CONNECTOR WITH GASKET

- Includes all parts as shown

Fits: Air Valve, Exhaust Valve, Air-Outlet Valve and Fill Valve

Models: EZ9, EZ9k, EZ10, EZ10k, 1730E/EK, 2340E/EA/EK/EKA, 2540E/EA/EK/EKA, 3850E/EA & 3870E/EA

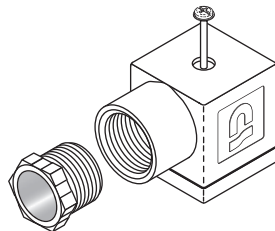

RPI Part #TUC084
OEM Part #01810909/01810910

WIRE CONNECTOR WITH GASKET

- Includes all parts as shown

Fits: Air Valve, Exhaust Valve, Air-Outlet Valve and Fill Valve

Models: EZ9, EZ9k, EZ10, EZ10k, 1730E/EK, 2340E/EA/EK/EKA, 2540E/EA/EK/EKA, 3850E/EA & 3870E/EA

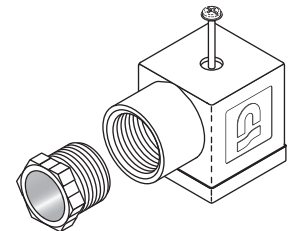

RPI Part #TUV042
OEM Part #CT844180

DRAIN VALVE ASSEMBLY

- Includes all parts as shown
- 3/8" barb x 5/16" tube
- Also available: Tubing (3/8" ID x 5/8" OD Clear) (RPI Part #RPH285) and O-Ring Lubricant (RPI Part #RPL615)

Models: EZ9, EZ9k, EZ10, EZ10k, ValueKlave (1730MKV), 1730E/EK/M/MK, 2340E/EA/EK/EKA/M/MK, 2540E/EA/EHS/EK/EKA/M/MK, 3850E/EA/EHS/M & 3870E/EA/EHS/M

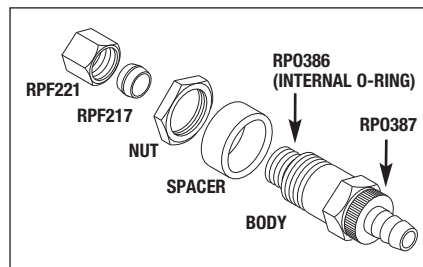

RPI Part #RPH285
OEM Part #02620016A

TUBING (3/8" ID x 5/8" OD CLEAR)

- Sold by the foot (reel not included)
 - Material: Clear PVC
- Models:** EZ9, EZ9k, EZ10, EZ10k, ValueKlave (1730MKV), 1730E/EK/M/MK, 2340E/EA/EK/EKA/M/MK, 2540E/EA/EHS/EK/EKA/M/MK, 3850E/EA/EHS/M & 3870E/EA/EHS/M

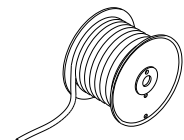
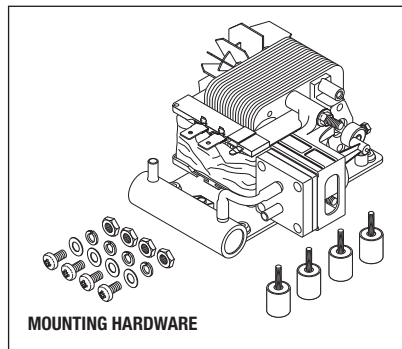

Table Top Sterilizers

Models: EZ9, EZ9k, EZ10, EZ10k, ValueKlave (1730MKV)™, 1730, 2340, 2540, 3850 & 3870 Series



MOUNTING HARDWARE

RPI Part #TUP100
OEM Part #02200051

AIR PUMP (115VAC)

- 115VAC, 60 Hz.; 1/4" Tabs
- Includes all parts as shown
- Also available: Air Pump Repair Kit (RPI Part #TUK102)

Fits: Machine Base

Models: Only fits the 120VAC units: EZ9, EZ10, 2340EA & 2540EA

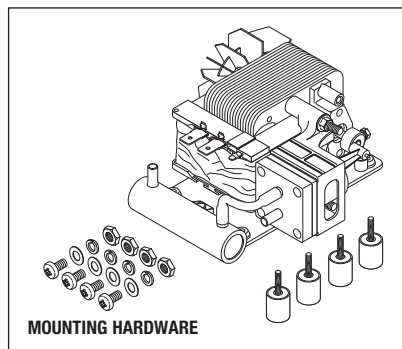

MOUNTING HARDWARE

RPI Part #TUP101
OEM Part #02200052

AIR PUMP (230VAC)

- 230VAC, 60 Hz.; 1/4" Tabs
- Includes all parts as shown
- Also available: Air Pump Repair Kit (RPI Part #TUK102)

Fits: Machine Base

Models: Only fits the 230VAC units: EZ9, EZ9k, EZ10, 2340EA/EKA, 2540EA, 3850EA & 3870EA

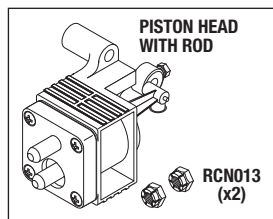

PISTON HEAD WITH ROD
RPI Part #TUK102
OEM Part # (No OEM Part # Available)

AIR PUMP REPAIR KIT

- Includes all parts as shown

Fits: Air Pump

Models: EZ9, EZ9k, EZ10, EZ10k, 2340EA/EKA, 2540EA/EK/EKA, 3850EA & 3870EA

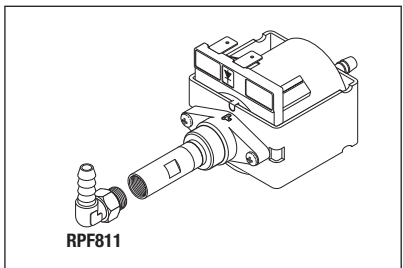

RPI Part #TUP089
OEM Part #PUM055-0005

WATER PUMP (120VAC)

- 1/4" Tabs
- Includes: Swivel Elbow Fitting (RPI Part #RPF811)
- Input: 1/4" Barb
- Also available: Pump Mounting Kit (RPI Part #TUK091)

Fits: Chassis

Models: Only fits the 120VAC units: EZ9, EZ10, 1730E/EK, 2340E/EA & 2540E/EA

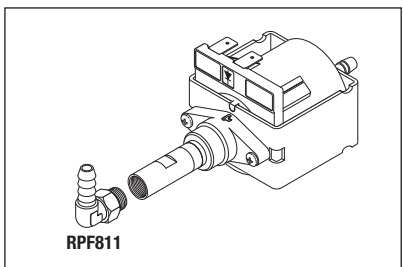

RPI Part #TUP090
OEM Part #PUM055-0007

WATER PUMP (230VAC)

- 1/4" Tabs
- Includes: Swivel Elbow Fitting (RPI Part #RPF811)
- Input: 1/4" Barb
- Also available: Pump Mounting Kit (RPI Part #TUK091)

Fits: Chassis

Models: Only fits the 230VAC units: EZ9, EZ9k, EZ10, EZ10k, 1730E/EK, 2340E/EA/EK/EKA, 2540E/EA/EK/EKA, 3850E/EA & 3870E/EA

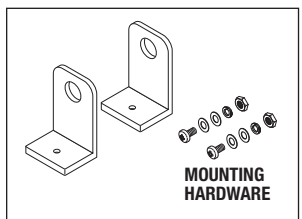

RPI Part #TUK091
OEM Part #SKR203-0006 (1 Rubber Mount Only)

PUMP MOUNTING KIT

- Includes all parts as shown

Fits: Mounts pump to chassis

Models: EZ9, EK9k, EZ10, EZ10k, 1730E/EK, 2340E/EA/EK/EKA, 2540E/EA/EK/EKA, 3850E/EA/EK/EK & 3870E/EA/EK/EK

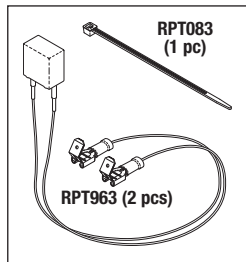

RPI Part #TUC138
OEM Part #
ELC258-0004

CAPACITOR (.47µF)

- Size: .709" lg. x .433" w. x .748" tall
- .47µF; 250VAC
- 13" lg. wires: (1) black and (1) red
- Includes all parts as shown

Fits: Water Pump

Models: EZ9, EZ9k, EZ10, EZ10k, 1730E/EK, 2340E/EA/EK/EKA, 2540E/EA/EK/EKA, 3850E/EA & 3870E/EA

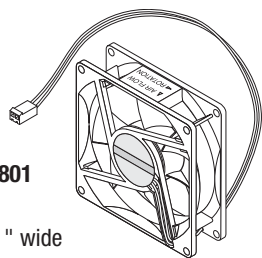

RPI Part #TUF071
OEM Part #04203801

AXIAL FAN

- 3.15" square x 1" wide
- 0.15A @ 12VDC
- Airflow: 32 CFM; 2500 RPM
- Dual ball bearings
- Includes all parts as shown

Fits: Chassis

Models: EZ9, EZ9k, EZ10, EZ10k, 1730E/EK, 2340E/EA/EK/EKA, 2540E/EA/EK/EKA, 3850E/EA & 3870E/EA

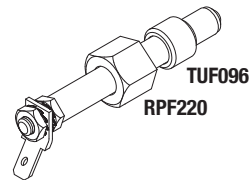

RPI Part #TUE080
OEM Part #CB930040

WATER FILL ELECTRODE

- 2.28" (58mm) long; 3/16" Tab
- Includes all parts as shown

Fits: Chamber

Models: EZ9, EZ9k, EZ10, EZ10k, 1730E/EK, 2340E/EA/EK/EKA, 2540E/EA/EK/EKA, 3850E/EA & 3870E/EA

RPI Part #TUF096
OEM Part #CB847140

FERRULE (PTFE)

- 5 per package
- Teflon; Fits 1/4" tubing
- Used with a 1/4" compression nut

Fits: Water Fill Electrode

Models: EZ9, EZ9k, EZ10, EZ10k, 1730E/EK, 2340E/EA/EK/EKA, 2540E/EA/EK/EKA, 3850E/EA & 3870E/EA

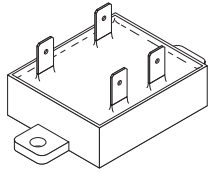

RPI Part #TUR105
OEM Part #04400339

SOLID STATE RELAY (PUMP)

- 1.50" W x 1.73" L x .55" Thk
- SPST - N.O.
- Current rating: 12A @ 24-280VAC
- Control voltage: 3-15 VDC
- 1/4" Tabs

Fits: Chassis

Models: EZ9, EZ9k, EZ10, EZ10k, 1730E/EK, 2340E/EA/EK/EKA, 2540E/EA/EK/EKA, 3850E/EA & 3870E/EA

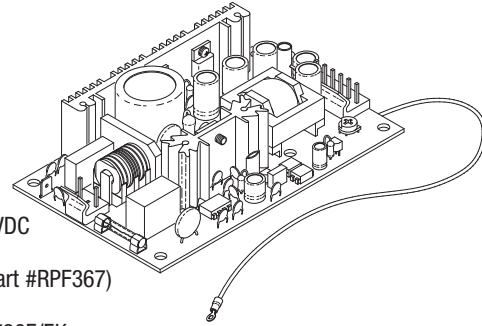

RPI Part #TUP106
OEM Part #04400299

POWER SUPPLY

- 45W dual output switching Power Supply
- Input voltage: 90 to 264VAC
- Output voltage:
Ch.1=3.2A@5VDC; Ch. 2=2A@12VDC
- Also available: Fuse (2A, 250V) - 5mm x 20mm - Fast Acting (RPI Part #RPF367)

Fits: Chassis

Models: EZ9, EZ9k, EZ10, EZ10k, 1730E/EK, 2340E/EA/EK/EKA, 2540E/EA/EK/EKA, 3850E/EA & 3870E/EA

RPI Part #RPT661

OEM Part # (No OEM Part # Available)

CABLE TIE (6" WHITE)

- 25 per package
- 1/8" X 6" lg.
- Material: Nylon

Models: EZ9, EZ9k, EZ10, EZ10k, ValueKlave (1730MKV), 1730E/EK/M/MK, 2340E/EA/EK/EKA/M/MK, 2540E/EA/EHS/EK/EKA/M/MK, 3850E/EA/EHS/M & 3870E/EA/EHS/M



RPI Part #RXT003

OEM Part # (No OEM Part # Available)

WRENCH (LOW PROFILE)

- Material: Stainless Steel
- Double Ended Flat Wrench: 7/16" x 10mm
- Used on Tuttnauer sterilizer Leveling Feet and Air Jet Valves.

Models: EZ9, EZ9k, EZ10, EZ10k, ValueKlave (1730MKV), 1730E/EK/M/MK, 2340E/EA/EK/EKA/M/MK, 2540E/EA/EHS/EK/EKA/M/MK, 3850E/EA/EHS/M & 3870E/EA/EHS/M

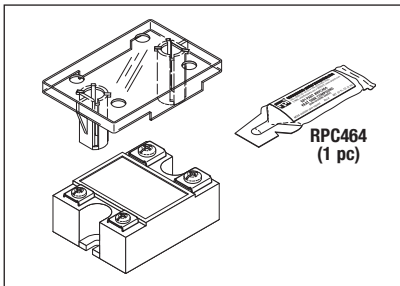
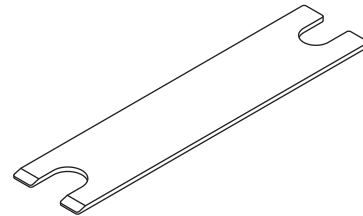

RPI Part #TUR104

OEM Part #04400338/CTP201-0067 (Cover Only)

SOLID STATE RELAY (HEATER)

- 1.80" W x 2.30" L x .90" Thk.
- SPST - N.O.
- Current rating: 25A @ 24-280 VAC
- Control voltage: 3-32 VDC
- Includes: Terminal hardware, Clear Plastic Cover, and (one tube) Heat Sink Compound (RPI Part #RPC464)

Fits: Chassis

Models: EZ9, EZ9k, EZ10, EZ10k, 1730E/EK, 2340E/EA/EK/EKA, 2540E/EA/EK/EKA, 3850E/EA & 3870E/EA

RPI Part #RPC464

OEM Part #

(No OEM Part # Available)

HEAT SINK COMPOUND

- 5 per package; Size: .07 fl. oz. (2 ml)
- Non-Silicone based thermal grease

Models: EZ9, EZ9k, EZ10, EZ10k, 1730E/EK, 2340E/EA/EK/EKA, 2540E/EA/EHS/EK/EKA, 3850E/EA/EHS & 3870E/EA/EHS



RPI Part #RPH659
OEM Part #01910103

FUSE HOLDER

- Accommodates standard 3AG (1/4" dia. x 1-1/4" lg.) fuse
- 20A @ 250 VAC; 3/16" Tabs
- Low profile screwdriver slot knob
- Mounting hole size: 1/2"
- Includes mounting hardware

Fits: Rear Panel

Models: EZ9, EZ9k, EZ10, EZ10k, ValueKlave (1730MKV), 1730E/EK/M/MK, 2340E/EA/EK/EKA/M/MK, 2540E/EA/EHS/EK/EKA/M/MK, 3850E/EA/EHS/M & 3870E/EA/EHS/M

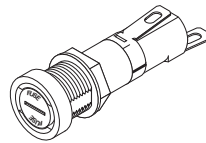

RPI Part #RPF047

OEM Part #ELE035-0056

FUSE (2A, 250VAC) - 1/4" x 1-1/4" FAST ACTING

- 5 per package
- Type: Glass; AGC Fast Acting
- Size: 1/4" dia. x 1-1/4" lg.
- Also available in Fuse Kit (RPI Part #RPK410)

Fits: Air Pump Fuse Holder

Models: Fits 120VAC units only: EZ9, EZ10, 2340EA & 2540EA

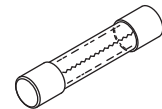

RPI Part #RPF073

OEM Part #ELE035-0055

FUSE (1-1/4A, 250VAC) - 1/4" x 1-1/4" FAST ACTING

- 5 per package
- Type: Glass; AGC Fast Acting
- Size: 1/4" dia. x 1-1/4" lg.
- Also available in Fuse Kit (RPI Part #RPK410)

Fits: Air Pump or Water Pump Fuse Holder depending on voltage

Models: EZ9, EZ9k, EZ10, EZ10k, 1730E/EK, 2340E/EA/EK/EKA, 2540E/EA/EHS/EK/EKA & 3850E/EA/EHS & 3870E/EA/EHS

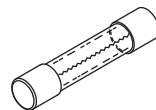

RPI Part #RPF071

OEM Part #01910106

FUSE (15A, 250VAC) - 1/4" x 1-1/4" TIME DELAY

- 5 per package
- Type: Ceramic; Time Delay
- Size: 1/4" dia. x 1-1/4" lg.
- Also available in Fuse Kit (RPI Part #RPK411)

Fits: Air Pump Fuse Holder

Models: ValueKlave (1730MKV), 1730M/MK, 2340M/MK, 2540M/MK, 3850M & 3870M

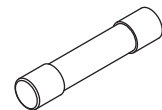

Table Top Sterilizers

Models: EZ9, EZ9k, EZ10, EZ10k, ValueKlave (1730MKV)™, 1730, 2340, 2540, 3850 & 3870 Series

1730 Series

RPI Part #TUK163
OEM Part #TRH173-0005 (Tray Holder)/**TRY173-0008** Tray (Wire)

HOLDER AND TRAY KIT

- Material: Stainless steel
- Includes all parts as shown
- All parts also sold separately
- Also available: Tutt-Clean™ Box of (10) Packets (RPI Part #TUC094), Cleaning Kit (RPI Part #RPK791) and Sci-Dry (2 oz. Bottle) (RPI Part #SCA054)

Fits: Chamber

Models: Valueklave (1730MKV) & 1730E/EK/M/MK

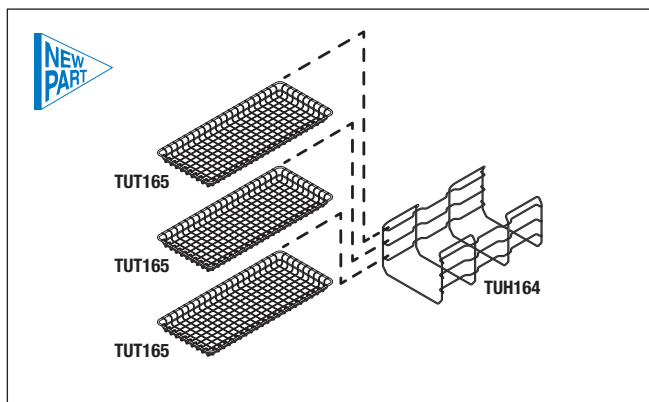

RPI Part #TUH164
OEM Part #TRH173-0005
 (Replaces CU510010)
TRAY HOLDER

RPI Part #TUT165
OEM Part #TRY173-0008
 (Replaces CU520010)

TRAY (WIRE)
 • Size: 5.46" x 12.25"

EZ9 & 2340 Series

RPI Part #TUK166
OEM Part #TRH234-0012 (Tray Holder)/**TRY254-0003** Tray (Wire)

HOLDER AND TRAY KIT

- Material: Stainless steel
- Includes all parts as shown
- All parts also sold separately
- Also available: Tutt-Clean™ Box of (10) Packets (RPI Part #TUC094), Cleaning Kit (RPI Part #RPK791) and Sci-Dry (2 oz. Bottle) (RPI Part #SCA054)

Fits: Chamber

Models: EZ9, EZ9k & 2340E/EA/EK/EKA/M/MK

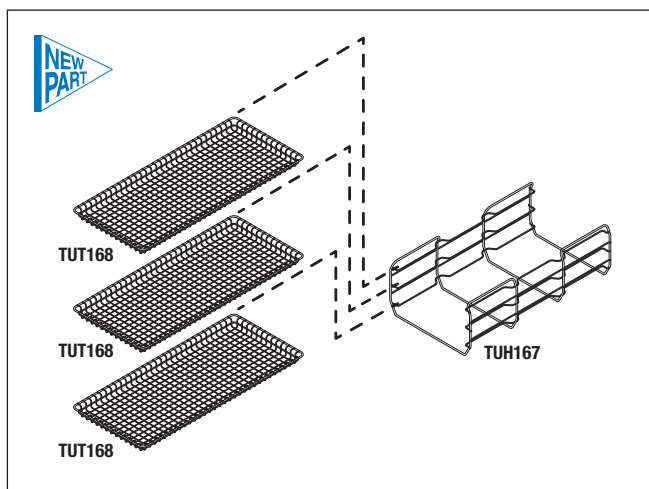

RPI Part #TUH167
OEM Part #TRH234-0012
 (Replaces CT510010)
TRAY HOLDER

RPI Part #TUT168
OEM Part #TRY254-0003
 (Replaces CT520010)

TRAY (WIRE)
 • Size: 17.39" x 7.60"

EZ10 & 2540 Series

RPI Part #TUK169
OEM Part #TRH254-0036 (Tray Holder)/**TRY254-0003** Tray (Wire)

HOLDER AND TRAY KIT

- Material: Stainless steel
- Includes all parts as shown
- All parts also sold separately
- Also available: Tutt-Clean™ Box of (10) Packets (RPI Part #TUC094), Cleaning Kit (RPI Part #RPK791) and Sci-Dry (2 oz. Bottle) (RPI Part #SCA054)

Fits: Chamber

Models: EZ10, EZ10k & 2540E/EK/EKA/M/MK

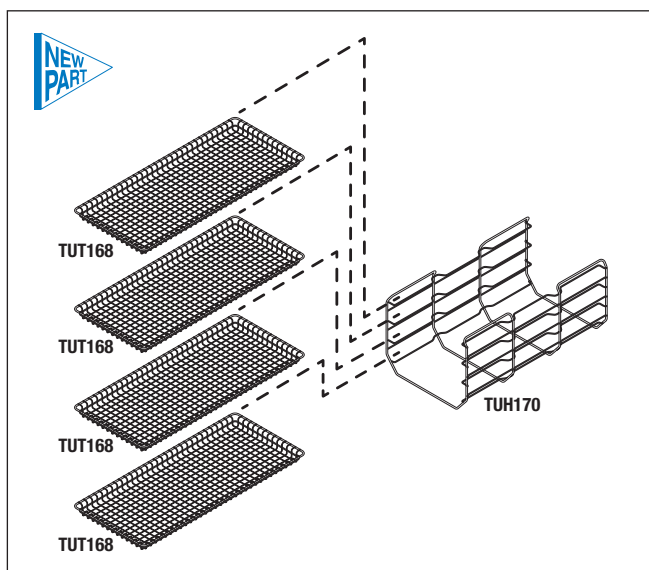

RPI Part #TUH170
OEM Part #TRH254-0036
 (Replaces CV510010)
TRAY HOLDER

RPI Part #TUT168
OEM Part #TRY254-0003
 (Replaces CT520010)

TRAY (WIRE)
 • Size: 17.39" x 7.60"

3870 Series

RPI Part #TUK171
OEM Part #
CC510010 (Tray Holder)/
CC520010 (Large Tray)/
CC520020 (Small Tray)

HOLDER AND TRAY KIT

- Material: Stainless steel
- Includes all parts as shown
- All parts also sold separately
- Also available: Tutt-Clean[™] Box of (10) Packets (RPI Part #TUC094), Cleaning Kit (RPI Part #RPK791) and Sci-Dry (2 oz. Bottle) (RPI Part #SCA054)

Fits: Chamber

Models: 3870E/EA/EK/EKA/M/MK

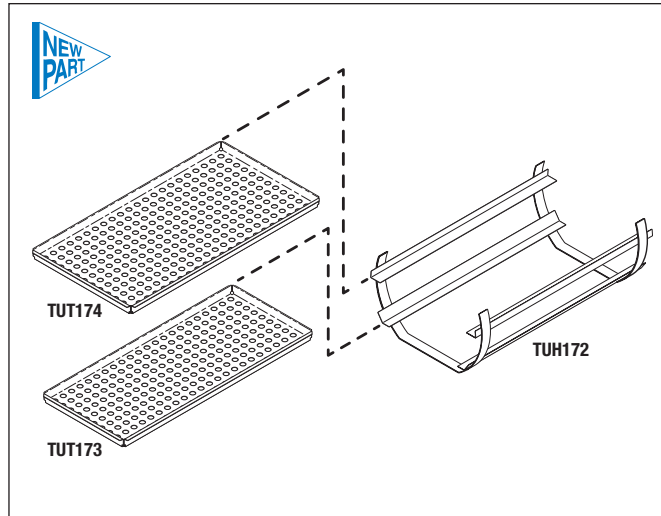

RPI Part #TUH172
OEM Part #CC510010
TRAY HOLDER

RPI Part #TUT173
OEM Part #CC520020
TRAY (SMALL)
 • Size: 27.21" x 11.87"

RPI Part #TUT174
OEM Part #CC520010
TRAY (LARGE)
 • Size: 27.21" x 14.43"

Cleaning Supplies

Keep The Chamber Clean!

To keep the chamber up-and-running, use a sterilizer cleaner that is a mild cleaning compound, formulated for descaling and removing water deposits, oxides, and other sediments that collect in the chamber.

RPI Part #TUC094
OEM Part #CB0010

TUTT-CLEAN[™]

- Sterilizer cleaner
- (1) Box of 10 packets
- Also available: Tutt-Clean[™] case of 12 boxes (RPI Part #TUC095)

Models: EZ9, EZ9k, EZ10, EZ10k, ValueKlave (1730MKV), 1730E/EK/M/MK, 2340E/EA/EK/EKA/M/MK, 2540E/EA/EHS/EK/EKA/M/MK, 3850E/EA/EHS/M & 3870E/EA/EHS/M



Keep Trays and Racks Looking Like New!

To keep trays and racks looking new, use a good drying and rinse agent that is a true surfactant to repel moisture and condensation – leaving the metal surfaces clean and bright!

RPI Part #SCA054
OEM Part # (No OEM Part # Available)

SCI-DRY[™] (2 oz.)

- Drying and rinse agent
- (1) 2 oz. spray bottle
- Also available:

Sci-Dry[™] case of 12 (2 oz.) spray bottles (RPI Part #SCA055),
 Sci-Dry[™] 16 oz. Refill Bottle (RPI Part #SCA046),
 Sci-Dry[™] case of 12 of the 16 oz. Refill Bottle (RPI Part #SCA047)



Use the Right Cleaning Tools!

RPI's Cleaning Kit includes all of the tools needed to clean the entire sterilizer – inside and out. The sturdy canvas carrying case is designed to keep organized the multiple sized brushes, sponges, and pads. All parts are also sold separately.

RPI Part #RPK791
OEM Part # (No OEM Part # Available)

CLEANING KIT

- Supplied in a convenient sturdy canvas Carrying Case (RPI Part #RPC799)
- Includes all parts as shown
- All parts also sold separately!

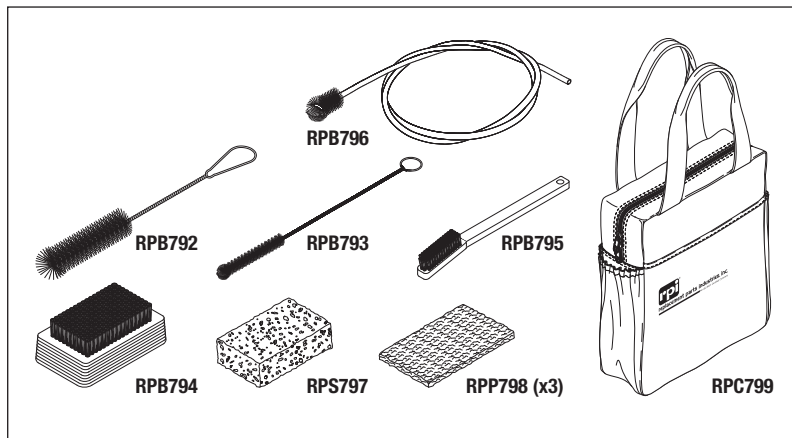

Tables & Chairs (Exam/Surgical)

Models: 2K60, 2K87, 2K89, 2K150, 2K160, 2K191 & 2K260

RPI Part #HAB009
OEM Part # (No OEM Part # Available)

BOLT

- 6 per package
- 1/4-20 x 7/8" Lg.
- Fits:** Power Pack Assembly
- Models:** 2K60, 2K87, 2K89, 2K150, 2K160, 2K191 & 2K260

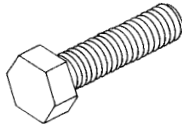

RPI Part #HAN013
OEM Part # (No OEM Part # Available)

LOCKNUT

- 6 per package
- 1/4-20
- Stainless
- Fits:** Power Pack Assembly
- Models:** 2K60, 2K87, 2K89, 2K150, 2K160, 2K191 & 2K260

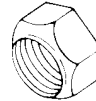

RPI Part #HAS010
OEM Part # (No OEM Part # Available)

SLEEVE

- 6 per package
- 1/4" ID x .438" Lg.
- Fits:** Grommet
- Models:** 2K60, 2K87, 2K89, 2K150, 2K160, 2K191 & 2K260

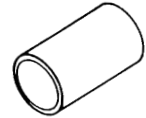

RPI Part #HAG011
OEM Part # (No OEM Part # Available)

GROMMET

- 6 per package
- Fits:** Power Pack Assembly
- Models:** 2K60, 2K87, 2K89, 2K150, 2K160, 2K191 & 2K260

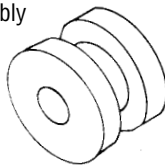

RPI Part #HAN017
OEM Part # (No OEM Part # Available)

HEX NUT

- 4 per package
- 8-32
- Brass
- Models:** 2K60, 2K87, 2K89, 2K150, 2K160, 2K191 & 2K260



RPI Part #HAW012
OEM Part # (No OEM Part # Available)

WASHER

- 6 per package
- 1/4" Flat (CRS)
- Fits:** Power Pack Assembly
- Models:** 2K60, 2K87, 2K89, 2K150, 2K160, 2K191 & 2K260



RPI Part #HAK016
OEM Part # (No OEM Part # Available)

CLEVIS KEY

- 4 per package
- 3/8" Dia. x 1-1/2" Lg.
- Zinc plated
- Fits:** Clevis Pin Rod and Cylinder
- Models:** 2K60, 2K87, 2K89, 2K150, 2K160, 2K191 & 2K260

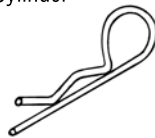

New RPI Part #RP0331
Old RPI Part #HA0008
OEM Part #54963
Industry Part #2-011

O-RING

- 6 per package
- .301" ID x .441" OD x .070" C/S
- Material: Neoprene; Duro: 70
- Fits:** Cylinders
- Models:** 2K60, 2K87, 2K89, 2K150, 2K160, 2K191 & 2K260



RPI Part #PCB134
OEM Part # (No OEM Part # Available)

ELECTRICAL TERMINAL BUSHING

- 3 per package
- Accommodates .25" tab
- 11/16" dia.
- Models:** 2K60, 2K87, 2K89, 2K150, 2K160, 2K191 & 2K260

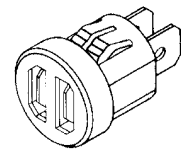

New RPI Part #LMP015
Old RPI Part #HAL007
OEM Part #48693

WARMER LAMP

- 120VAC, 25W
- Fits:** Instrument Warmer Drawer
- Models:** 2K60, 2K87, 2K89, 2K150, 2K160, 2K191 & 2K260

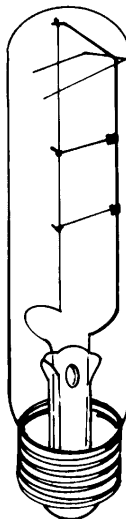

RPI Part #HAP014
OEM Part # (No OEM Part # Available)

CLEVIS PIN (ROD)

- 2 per package
- 3/8" dia. x 1-1/8" Lg.
- Zinc plated
- Fits:** Cylinder
- Models:** 2K60, 2K87, 2K89, 2K150, 2K160, 2K191 & 2K260

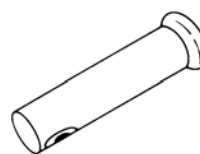

RPI Part #PCN136
OEM Part # (No OEM Part # Available)

SPEEDNUT

- 10 per package
- "U" type 10-24 thread
- Models:** 2K60, 2K87, 2K89, 2K150, 2K160, 2K191 & 2K260



O-Ring illustrations are actual size

Our customer service department is just a phone call away.

Tables & Chairs (Exam/Surgical)

Models: 2K60, 2K87, 2K89, 2K150, 2K160, 2K191 & 2K260 (continued)

RPI Part #HAA001
OEM Part # (No OEM Part # Available)

MOTOR AND PUMP ASSEMBLY

- Two capacitors (RPI Part #MIC019) are required when replacing old style brush motor with this motor and pump assembly

Fits: Power Pack Assembly
Models: 2K60, 2K87, 2K89, 2K150, 2K160, 2K191 & 2K260

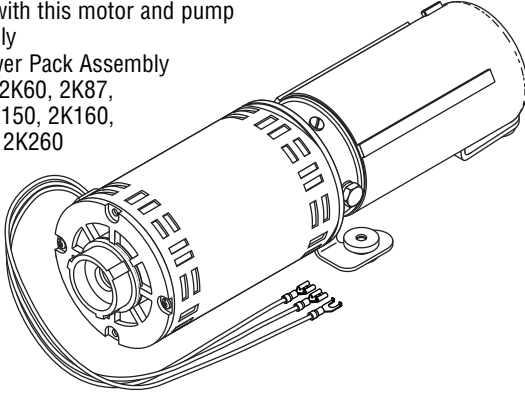

RPI Part #MIC019
OEM Part # (No OEM Part # Available)

CAPACITOR

- 1.81" dia. X 4.38" lg.
- Dual .25" tabs
- 124-149 µf; 250VAC, 60 Hz.

Fits: Power Pack Assembly
Models: 2K60, 2K87, 2K89, 2K150, 2K160, 2K191 & 2K260

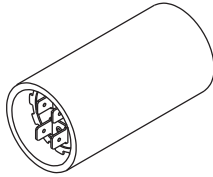

Warning: When attaching hydraulic hoses to the cylinders, torque the hose fittings between 55 - 60 Inch Pounds only. Additional torque could damage the threads in the cylinder.

RPI Part #HAH005
OEM Part #54962

HOSE ASSEMBLY (~85-1/2")

- Power side - bottom of cylinder

Fits: Cylinder
Models: 2K60, 2K87, 2K89, 2K150, 2K160, 2K191 & 2K260

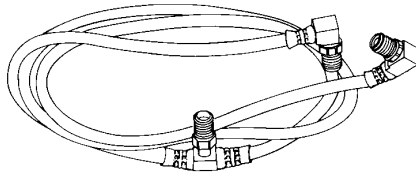

RPI Part #HAH006
OEM Part #54961

HOSE ASSEMBLY (~97-1/2")

- Return side - top of cylinder

Fits: Cylinder
Models: 2K60, 2K87, 2K89, 2K150, 2K160, 2K191 & 2K260

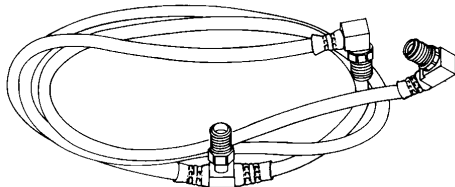

Warning: When attaching hydraulic hoses to the cylinders, torque the hose fittings between 55 - 60 Inch Pounds only. Additional torque could damage the threads in the cylinder.

RPI Part #HAC003
OEM Part #54959

TOP CYLINDER

- 2.12" OD x ~15" Lg. - Center hole to center hole (retracted)
- Includes Cylinder and (3 pieces) Cable Tie (12" Black) (RPI Part #RPT375)

Fits: Table Back
Models: 2K60, 2K87, 2K89, 2K150, 2K160, 2K191 & 2K260

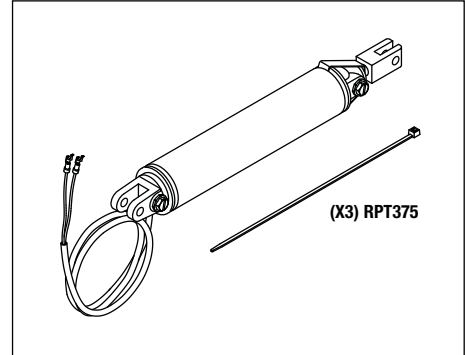

RPI Part #HAC004
OEM Part #54960

TABLE CYLINDER

- ~19.25" Lg. - Center hole to center hole (retracted)
- Includes Cylinder and (3 pieces) Cable Tie (12" Black) (RPI Part #RPT375)

Fits: Table Base
Models: 2K60, 2K87, 2K89, 2K150, 2K160, 2K191 & 2K260

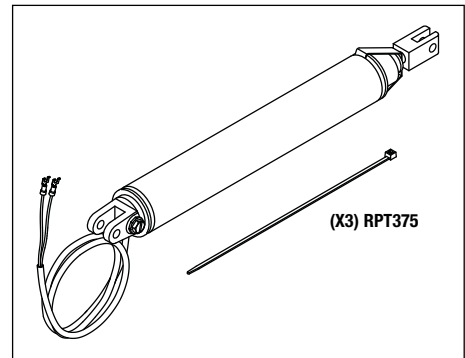

RPI Part #RPF384
OEM Part # (No OEM Part # Available)

HYDRAULIC FLUID

- 32 fl. oz. (.946 Liter)
 - Additive-free 100N Mineral Oil
- Models:** 2K60, 2K87, 2K89, 2K150, 2K160, 2K191 & 2K260

Also available by the case (12 units) (RPI Part #RPF722)



Tables & Chairs (Exam/Surgical)

Models: Evolution 75, 75L, 100, 200, 300, 400 and 600 Series

* See www.rpiparts.com for the Model/Serial # breakdown by part.

RPI Part #RPF384
OEM Part #014-0056-00 / 014-0020-00

HYDRAULIC FLUID

- ISO22 / SAE 10W
- 32 fl. oz. (.946 Liter)
- Additive-free 100N Mineral Oil
- Includes yorker spout

*Models: Evolution 75, 105, 106, 107, 110, 111, 112, 113, 114, 115, 116, 117, 119, 305, 306, 307, 311, 317, 318 & 319



Also available
by the case (12 units)
(RPI Part #RPF722)

RPI Part #MIA124
OEM Part #002-0112-00

MOTOR/PUMP ASSEMBLY

- 115 VAC, 50/60 Hz; 1/2 HP
- 3/4 GPM pump with 1/2-20 inverted flare ports
- Also available Hydraulic Fluid (RPI Part #RPF384) and Capacitor (25-36 µF, 330VAC) (RPI Part #MIC019)

Fits: Chassis
*Models: 105, 107, 305 & 307

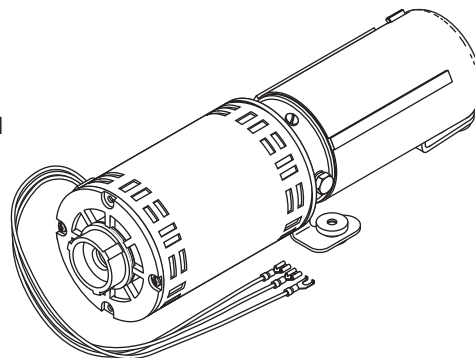

WARNING: When attaching hydraulic hoses to the cylinders, torque the hose fittings between **55 - 60 Inch Pounds only**. Additional torque could damage the threads in the cylinders. When replacing hydraulic hoses, route hose exactly as the original was installed to avoid pinching, chaffing and premature wear. Remember to replace any removed clamps, cable ties and safety devices when installing new cylinders and hoses.

RPI Part #MIC063
OEM Part #002-0001-00

BASE CYLINDER KIT

- Includes all parts as shown
- Fits: Table base

*Models: Evolution 75, 106, 110, 111, 112, 113, 114, 116, 117, 119, 306, 311, 317, 318 & 319

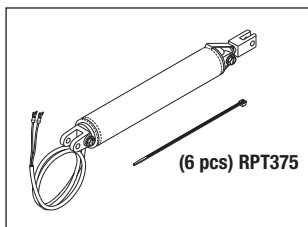

RPI Part #MIC089
OEM Part #002-0094-00

BASE CYLINDER

- Includes all parts as shown
- Fits: Table Base

*Models: 105, 107, 305 & 307

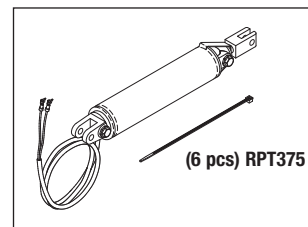

RPI Part #MIC064
OEM Part #002-0002-00

TILT CYLINDER KIT

- Includes all parts as shown
- Fits: Table Base

*Models: Evolution 75, 110, 111, 114, 116, 119, 311, 318 & 319

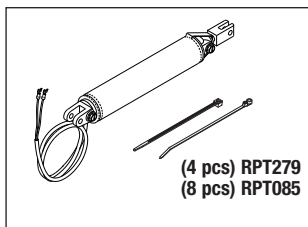

RPI Part #MIC065
OEM Part #002-0003-00

BACK/FOOT CYLINDER KIT

- Includes all parts as shown
- Fits: Table Back and/or Foot Section

*Models: Evolution 75, 110, 111, 112, 113, 114, 116, 117, 119, 311, 318 & 319

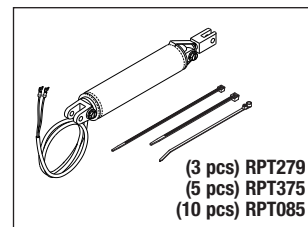

RPI Part #MIC112
OEM Part #002-0137-00

TILT CYLINDER

- Includes all parts as shown
- Fits: Table Base

*Models: 112, 113 & 117

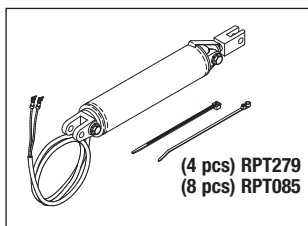

RPI Part #MIC111
OEM Part #002-0100-00

BACK CYLINDER

- Includes all parts as shown
- Fits: Table Back

*Models: 105 & 305

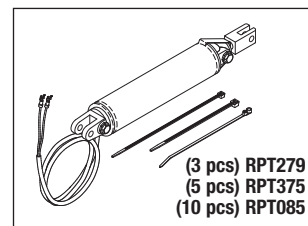

RPI Part #MIC113
OEM Part #002-0271-00

TILT CYLINDER

- Includes all parts as shown
- Fits: Table Base

*Models: 117 & 317

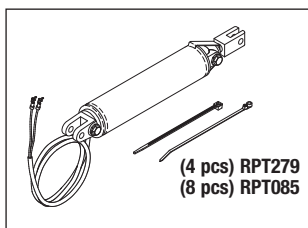

RPI Part #MIC114
OEM Part #002-0346-00

BACK CYLINDER

- Includes all parts as shown
- Fits: Table Back

*Models: Evolution 75, 117, 119, 311, 317, 318 & 319

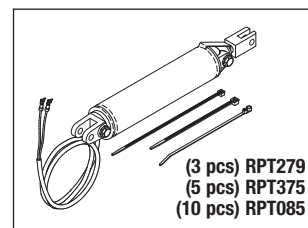

Call Us Toll-Free Monday-Friday, 8:00 AM-4:30 PM (Pacific Time), (800) 221-9723

Tables & Chairs (Exam/Surgical)

Models: Evolution 75, 75L, 100, 200, 300, 400 and 600 Series (continued)

* See www.rpiparts.com for the Model/Serial # breakdown by part.

WARNING: When attaching hydraulic hoses to the cylinders, torque the hose fittings between **55 - 60 Inch Pounds only**. Additional torque could damage the threads in the cylinders. When replacing hydraulic hoses, route hose exactly as the original was installed to avoid pinching, chaffing and premature wear. Remember to replace any removed clamps, cable ties and safety devices when installing new cylinders and hoses.

RPI Part #MIH104
OEM Part #002-0004-00

POWER HOSE

- Length: 75"
- Fittings: 1/2-20 Inverted Flare

Fits: Connects Motor/Pump to bottom of Hydraulic Cylinders

*Model: 110

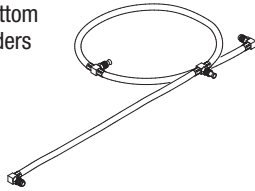

RPI Part #MIH106
OEM Part #002-0005-00

RETURN HOSE

- Length: 104-1/2"
- Fittings: 1/2-20 Inverted Flare

Fits: Connects Motor/Pump to top of Hydraulic Cylinders

*Model: 110

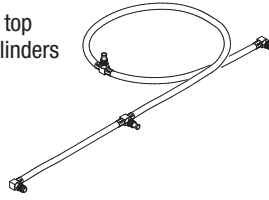

RPI Part #MIH067
OEM Part #002-0014-00

POWER HOSE KIT

- Length: 80"
- Fittings: 1/2-20 Inverted Flare

Fits: Connects Motor/Pump to bottom of Hydraulic Cylinders

*Models: 111 & 114

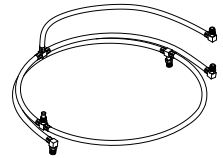

RPI Part #MIH105
OEM Part #002-0109-00

POWER HOSE

- Length: 67-1/2"
- Fittings: 1/2-20 Inverted Flare

Fits: Connects Motor/Pump to bottom of Hydraulic Cylinders

*Model: 105

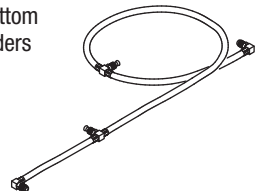

RPI Part #MIH109
OEM Part #002-0110-00

RETURN HOSE

- Length: 54"
- Fittings: 1/2-20 Inverted Flare

Fits: Connects Motor/Pump to top of Hydraulic Cylinders

*Model: 105

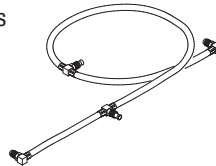

RPI Part #MIH068
OEM Part #002-0012-00

RETURN HOSE KIT

- Length: 104"
- Fittings: 1/2-20 Inverted Flare

Fits: Connects Motor/Pump to bottom of Hydraulic Cylinders

*Models: 111 & 114

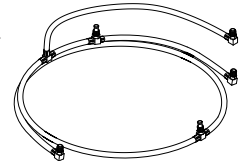

RPI Part #MIH108
OEM Part #002-0099-00

POWER HOSE

- Length: 46"
- Fittings: 1/2-20 Inverted Flare

Fits: Connects Motor/Pump to bottom of Hydraulic Cylinders

*Models: 105 & 305

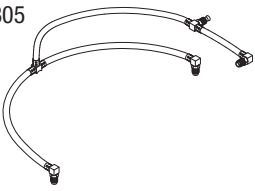

RPI Part #MIH107
OEM Part #002-0098-00

RETURN HOSE

- Length: 38"
- Fittings: 1/2-20 Inverted Flare

Fits: Connects Motor/Pump to top of Hydraulic Cylinders

*Models: 105 & 305

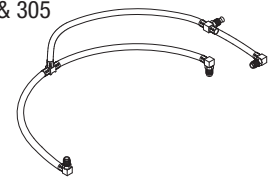

RPI Part #MIH070
OEM Part #002-0021-00

RETURN HOSE KIT

- Length: 83"
- Fittings: 1/2-20 Inverted Flare

Fits: Connects Motor/Pump to bottom of Hydraulic Cylinders

*Models: 111 & 114

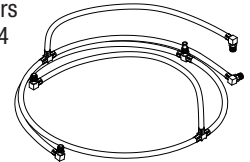

RPI Part #MIH103
OEM Part #002-0096-00

POWER HOSE

- Length: 60"
- Fittings: 1/2-20 Inverted Flare

Fits: Pump to Base

*Models: 107 & 307

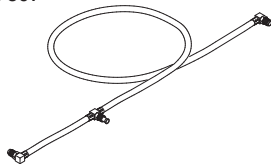

RPI Part #MIH102
OEM Part #002-0095-00

RETURN HOSE

- Length: 50"
- Fittings: 1/2-20 Inverted Flare

Fits: Pump to Base

*Models: 107 & 307

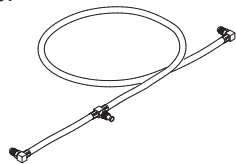

RPI Part #RPT085

CABLE TIE (8" BLACK)

- 25 per package
- 3/16" x 8" lg.

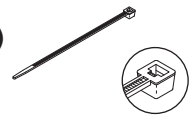

RPI Part #RPT279

CABLE TIE (8" BLACK)

- 25 per package
- 3/16" x 8" lg.



RPI Part #RPT375

CABLE TIE (12" BLACK)

- 25 per package
- 3/16" x 12" lg.

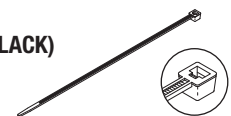

Tables & Chairs (Exam/Surgical)

Models: Evolution 75, 75L, 100, 200, 300, 400 and 600 Series (continued)

* See www.rpiparts.com for the Model/Serial # breakdown by part.

WARNING: When attaching hydraulic hoses to the cylinders, torque the hose fittings between **55 - 60 Inch Pounds only**). Additional torque could damage the threads in the cylinders. When replacing hydraulic hoses, route hose exactly as the original was installed to avoid pinching, chaffing and premature wear. Remember to replace any removed clamps, cable ties and safety devices when installing new cylinders and hoses.

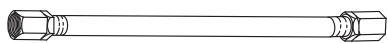

RPI Part #MIH003
OEM Part #002-0119-00

POWER HOSE KIT

- Length: 14"
- Fitting: 7/16-20 female both ends

Fits: Pump to Base

***Models:** Evolution 75, 111, 112, 113, 114, 116, 117, 119, 311, 317, 318 & 319

RPI Part #MIH001
OEM Part #002-0117-00 / 014-0104-00

PUMP HOSE KIT

- Length: 15"
- Fitting: 7/16-20 female both ends

Fits: Solenoid to Pump

***Models:** Evolution 75, 106, 111, 112, 113, 114, 116, 117, 119, 311 & 319

RPI Part #MIH002
OEM Part #002-0118-00

RETURN HOSE KIT

- Length: 18"
- Fitting: 7/16-20 female both ends

Fits: Pump to Base

***Models:** Evolution 75, 111, 112, 113, 114, 116, 117 & 119

RPI Part #MIH008
OEM Part #002-0178-00

RETURN HOSE KIT

- Length: 23-3/4"
- Fitting: 7/16 female both ends

Fits: Tilt to Back

***Models:** Evolution 75, 111, 112, 113, 114, 116, 117 & 119

RPI Part #MIH005
OEM Part #002-0121-00

POWER HOSE KIT

- Length: 26-1/2"
- Fitting: 7/16-20 female both ends

Fits: Base to Tilt

***Models:** Evolution 75, 111, 112, 113, 114, 116, 117, 119, 311, 317, 318 & 319

RPI Part #MIH006
OEM Part #002-0122-00

RETURN HOSE KIT

- Length: 37-1/2"
- Fitting: 7/16-20 female both ends

Fits: Base to Tilt

***Models:** Evolution 75, 111, 112, 113, 114, 116, 117, 119, 311, 317, 318 & 319

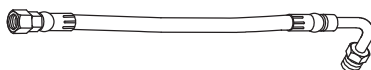

RPI Part #MIH100
OEM Part #002-0144-00/#002-0054-00

POWER HOSE

- Length: 13-3/4"
- Fittings: 7/16-20 Female x 1/2-20 Inverted Flare 90° Elbow

Fits: Pump to Base

***Models:** 106 & 306

RPI Part #MIH087
OEM Part #002-0126-00

RETURN HOSE KIT

- Length: 24-1/4"
- Fittings: 7/16-20 Female x 1/2-20 Inverted Flare 90° Elbow

Fits: Tilt to Back

***Models:** Evolution 75, 111, 112, 113, 114, 117, 119, 311, 317, 318 & 319

RPI Part #MIH101
OEM Part #002-0143-00 /#002-0053-00

RETURN HOSE

- Length: 32"
- Fittings: 7/16-20 Female x 1/2-20 Inverted Flare 90° Elbow

Fits: Pump to Base

***Models:** 106 & 306

RPI Part #MIH085
OEM Part # 002-0124-00

RETURN HOSE KIT

- Length: 38-1/4"
- Fittings: 7/16-20 Female x 1/2-20 Inverted Flare 90° Elbow

Fits: Foot to Tilt

***Models:** Evolution 75, 111, 112, 114, 116, 119, 311 & 319

RPI Part #MIH084
OEM Part #002-0123-00

POWER HOSE KIT

- Length: 44-1/2"
- Fittings: 7/16-20 Female x 1/2-20 Inverted Flare 90° Elbow

Fits: Foot to Tilt

***Models:** Evolution 75, 111, 112, 114, 116, 119, 311, 318 & 319

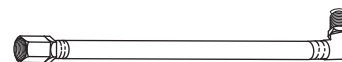

RPI Part #MIH007
OEM Part #002-0125-00

POWER HOSE KIT

- Length: 39-1/4"
- Fitting: 7/16-20 female x 1/2-20 Inverted Flare 90° Elbow

Fits: Tilt to Back

***Models:** Evolution 75, 111, 112, 113, 114, 116, 117, 119, 311, 317, 318 & 319

RPI Part #MIH004
OEM Part #002-0120-00

RETURN HOSE KIT

- Length: 15"
- Fitting: 7/16-20 female x 1/2-20 Inverted Flare 90° Elbow

Fits: Base to Return Line

***Models:** Evolution 75, 111, 112, 113, 114, 116, 117, 119, 311, 317, 318 & 319

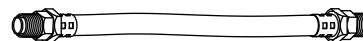

RPI Part #MIH071
OEM Part #002-0032-00

HOSE ASSEMBLY KIT

- Overall length: 6"
- Fittings: 1/2-20 Inverted Flare; 1/8 MPT Adaptor Fittings and O-rings

Fits: Attaches Motor/Pump assembly to elbow that connects to the return hose assembly

***Models:** 106, 111 & 114



RPI Part #MIH069
OEM Part #002-0031-00

HOSE ASSEMBLY KIT

- Length: 16-1/2"
- Fittings: 1/2-20 Inverted Flare; 1/8 MPT Adaptor Fittings and O-rings

Fits: Attaches to three connections on Motor/Pump assembly

***Models:** 106, 111 & 114

SERVICE TIP: When replacing hose assemblies, don't forget Cable Ties – see the previous page or General Shop Aids.

Tables & Chairs (Exam/Surgical)

Models: Evolution 75, 75L, 100, 200, 300, 400 and 600 Series (continued)

* See www.rpiparts.com for the Model/Serial # breakdown by part.

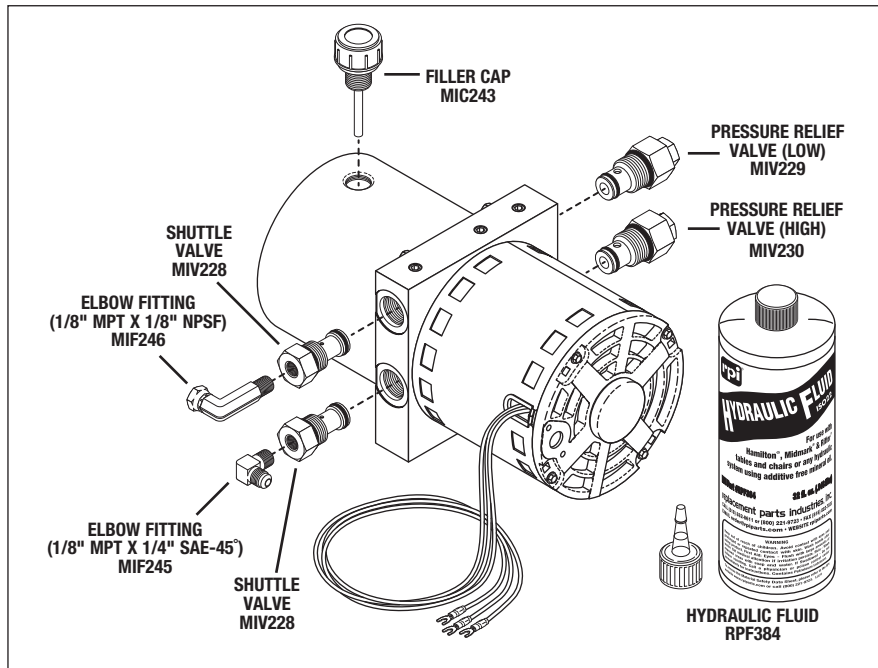

RPI Part #MIP242
OEM Part #002-0444-00, 014-0035-00, 002-0127-00, 002-0133-00 & 014-0262-00

PUMP ASSEMBLY

- 115 VAC, 60 HZ
- Includes all parts as shown
- Also available: Capacitor (25-36 µF, 330VAC) (RPI Part #MIC019), Motor Mount Kit (RPI Part #MIK231), and Anti-Cavitation Valve (RPI Part #MIV232)

Fits: Motor Base
***Models:** Evolution 75, 106, 111, 112, 113, 114, 116, 117, 119, 306, 311, 317, 318 & 319

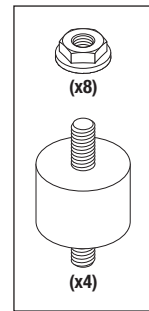

RPI Part #MIK231
OEM Part #053-0051-00

MOTOR MOUNT KIT

- Includes all parts as shown
- Material: Rubber vibration mount with 1/4-20 male threads

Fits: Motor Base and Pump
***Models:** Evolution 75, 106, 111, 112, 113, 114, 116, 117, 119, 306, 311, 317, 318 & 319

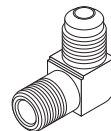

RPI Part #MIF245
OEM Part #014-0096-00

ELBOW FITTING
(1/8\"/>

- Material: Brass
 - Included in: Anti-Cavitation Valve (RPI Part #MIV232) and Pump Assembly (RPI Part #MIP242)
- Fits:** Anti-Cavitation Valve and Shuttle Valve
***Models:** Evolution 75, 105, 106, 107, 110, 111, 112, 113, 114, 115, 116, 117, 119, 305, 306, 307, 311, 317, 318 & 319

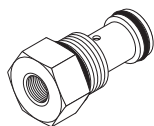

RPI Part #MIV228
OEM Part #014-0168-00

SHUTTLE VALVE

- Port: 1/8" FPT
- Included in: Pump Assembly (RPI Part #MIP242)

Fits: Pump Assembly
***Models:** Evolution 75, 106, 111, 112, 113, 114, 116, 117, 119, 306, 311, 317, 318 & 319

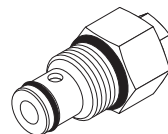

RPI Part #MIV230
OEM Part #014-0249-00

PRESSURE RELIEF VALVE (HIGH)

- 675 PSI Cracking Pressure
- Body marked "600"
- Included in: Pump Assembly (RPI Part #MIP242)

Fits: Pump Assembly
***Models:** Evolution 75, 106, 111, 112, 113, 114, 116, 117, 119, 306, 311, 317, 318 & 319

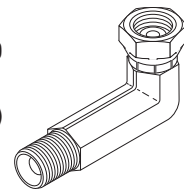

RPI Part #MIF246
OEM Part #014-0260-00

ELBOW FITTING
(1/8\"/>

- Material: Zinc plated steel
- Extended length elbow
- Included in: Anti-Cavitation Valve (RPI Part #MIV232) and Pump Assembly (RPI Part #MIP242)

Fits: Pump Assembly
***Models:** Evolution 75, 105, 106, 107, 110, 111, 112, 113, 114, 115, 116, 117, 119, 305, 306, 307, 311, 317, 318 & 319

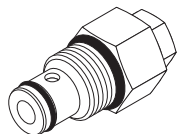

RPI Part #MIV229
OEM Part #014-0248-00

PRESSURE RELIEF VALVE (LOW)

- 400 PSI cracking pressure
- Body marked "L2"
- Included in: Pump Assembly (RPI Part #MIP242)

Fits: Pump Assembly
***Models:** Evolution 75, 106, 111, 112, 113, 114, 116, 117, 119, 306, 311, 317, 318 & 319

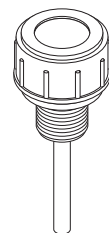

RPI Part #MIC243
OEM Part #014-0262-01

FILLER CAP

- Material: Black plastic
- Size: 3/8" MPT
- Includes: Dip stick
- Included in: Pump Assembly (RPI Part #MIP242)

Fits: Pump Assembly
***Models:** Evolution 75, 106, 111, 112, 113, 114, 116, 117, 119, 306, 311, 317, 318 & 319



RPI Part #RPF384
OEM Part #014-0056-00/014-0020-00

HYDRAULIC FLUID

- 32 fl. oz. (.946 Liter)
- Additive-free 100N Mineral Oil; ISO22/SAE 10W
- Included in: Pump Assembly (RPI Part #MIP242)

• Also available by the case (12 bottles) (RPI Part #RPF722)
***Models:** Evolution 75, 105, 106, 107, 110, 111, 112, 113, 114, 115, 116, 117, 119, 305, 306, 307, 311, 317, 318 & 319

* See www.rpiparts.com for the Model/Serial # breakdown by part.

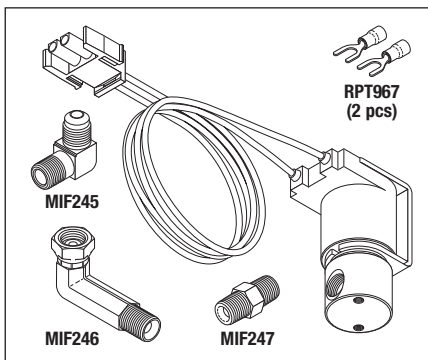

RPI Part #MIV232
OEM Part #002-0493-00/002-0038-00

ANTI-CAVITATION VALVE

- Ports: 1/8" FPT; 2-way; N.C.
- 120 VAC 50/60 Hz., 8W (~210 Ω); #18 AWG 18" lg. wires
- Material: Stainless steel body, FKM seals
- Includes all parts as shown

Fits: Pump Assembly

*Models: Evolution 75, 105, 106, 107, 110, 111, 112, 113, 114, 115, 116, 117, 119, 305, 306, 307, 311, 317, 318 & 319

RPI Part #MIK233
OEM Part #

(No OEM Part # Available)

ANTI-CAVITATION VALVE REPAIR KIT

- Viton (FKM) seals
- Includes all parts as shown

Fits: Anti-Cavitation Valve

*Models: Evolution 75, 105, 106, 107, 110, 111, 112, 113, 114, 115, 116, 117, 119, 305, 306, 307, 311, 317, 318 & 319

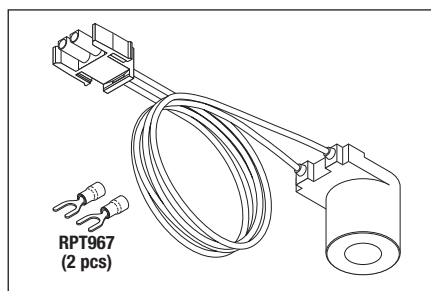
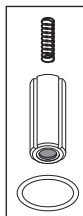

RPI Part #MIC227
OEM Part # (No OEM Part # Available)

COIL (ANTI-CAVITATION VALVE)

- 120 VAC 50/60 Hz., 8W (~210 Ω); #18 AWG 18" lg. wires
- Includes all parts as shown

Fits: Anti-Cavitation Valve

*Models: Evolution 75, 105, 106, 107, 110, 111, 112, 113, 114, 115, 116, 117, 119, 305, 306, 307, 311, 317, 318 & 319

RPI Part #MIF245
OEM Part #014-0096-00

ELBOW FITTING (1/8" MPT X 1/4" SAE-45°)

- Material: Brass
- Included in: Anti-Cavitation Valve (RPI Part #MIV232) and Pump Assembly (RPI Part #MIP242)

Fits: Anti-Cavitation Valve and Shuttle Valve
*Models: Evolution 75, 105, 106, 107, 110, 111, 112, 113, 114, 115, 116, 117, 119, 305, 306, 307, 311, 317, 318 & 319

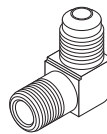

RPI Part #MIF246
OEM Part #014-0260-00

ELBOW FITTING (1/8" MPT X 1/8" NPSF)

- Material: Zinc plated steel
- Extended length elbow
- Included in: Anti-Cavitation Valve (RPI Part #MIV232) and Pump Assembly (RPI Part #MIP242)

Fits: Pump Assembly
*Models: Evolution 75, 105, 106, 107, 110, 111, 112, 113, 114, 115, 116, 117, 119, 305, 306, 307, 311, 317, 318 & 319

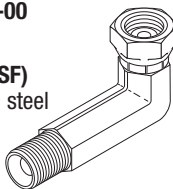

RPI Part #MIF247
OEM Part #014-0045-00

MALE CONNECTOR (1/8" MPT)

- 30° SAE internal chamfer for 1/8" NPSF swivel coupling
- Material: Zinc plated steel
- Included in: Anti-Cavitation Valve (RPI Part #MIV232)

Fits: Anti-Cavitation Valve
*Models: Evolution 75, 105, 106, 107, 110, 111, 112, 113, 114, 115, 116, 117, 119, 305, 306, 307, 311, 317, 318 & 319

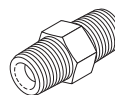

RPI Part #RPT967
OEM Part # (No OEM Part # Available)

SPADE TERMINAL (#8)

- 20 per package
- Wire range: #22-16 AWG
- Style: Insulated (Red)
- Also available: Terminal Crimp Tool (RPI Part #RPT482)

Fits: #8 Stud/22-16 AWG Wire
*Models: Evolution 75, 105, 106, 107, 110, 111, 112, 113, 114, 115, 116, 117, 119, 305, 306, 307, 311, 317, 318 & 319

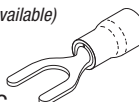

RPI Part #MIF244
OEM Part #014-0098-00

UNION TEE FITTING (1/4" SAE-45° FLARE)

- Material: Brass
- Fits: Pump Return Hose Line
- *Models: Evolution 75, 105, 106, 107, 110, 111, 112, 113, 114, 115, 116, 117, 119, 305, 306, 307, 311, 317, 318 & 319

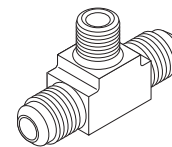

RPI Part #MIM222
OEM Part #014-0136-00

MANIFOLD (TILT POWER)

- Material: Brass
- (2) 1/4" SAE fittings x 5/16" inverted flare swivel fitting
- Fits: Tilt Cylinder Power Connection
- *Models: Evolution 75, 105, 106, 107, 110, 111, 112, 113, 114, 115, 116, 117, 119, 305, 306, 307, 311, 317, 318 & 319

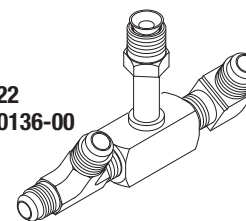

RPI Part #MIM223
OEM Part #014-0137-00

MANIFOLD (RETURN)

- Material: Brass
- (3) 1/4" SAE fittings x 5/16" inverted flare swivel fitting
- Fits: Tilt Cylinder Return Connection
- *Models: Evolution 75, 105, 106, 107, 110, 111, 112, 113, 114, 115, 116, 117, 119, 305, 306, 307, 311, 317, 318 & 319

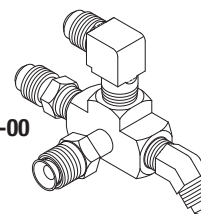

RPI Part #MIM224
OEM Part #014-0135-00

MANIFOLD (BASE TEE)

- Material: Brass
- (2) 1/4" SAE fittings x 5/16" inverted flare swivel fitting
- Fits: Base Cylinder Power Connection
- *Models: Evolution 75, 105, 106, 107, 110, 111, 112, 113, 114, 115, 116, 117, 119, 305, 306, 307, 311, 317, 318 & 319

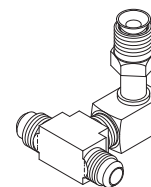

Tables & Chairs (Exam/Surgical)

Models: Evolution 75, 75L, 100, 200, 300, 400 and 600 Series (continued)

*** See www.rpiparts.com for the Model/Serial # breakdown by part.**

RPI Part #MIA215
OEM Part #002-0495-00

ACTUATOR (FOOT)

- 2.7A@115VAC
- Also available:
 Capacitor (25-36 μ F; 330VAC) (RPI Part #MIC182), and
 Brake & Coupler Kit (RPI Part #MIK167)

Fits: Foot Section

***Models:** 75L (411), 411 (75L) & 411

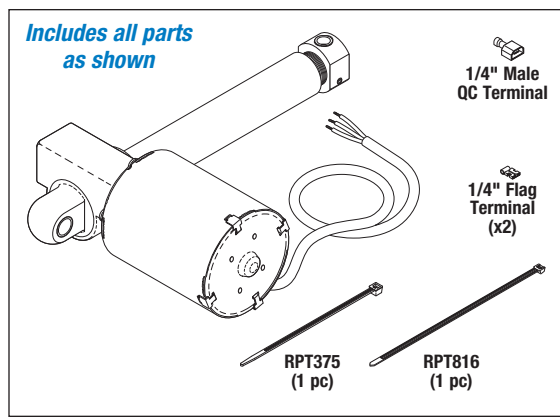

RPI Part #MIA218
OEM Part #002-0498-00 & 002-0498-02

ACTUATOR (TILT)

- 2.7A@115VAC
- Also available:
 Capacitor (36-43 μ F; 330VAC) (RPI Part #MIC219), and
 Brake & Coupler Kit (RPI Part #MIK167)

Fits: Seat Section

***Models:** Evolution 75, 75L (411), 411 (75L), 411 & 419

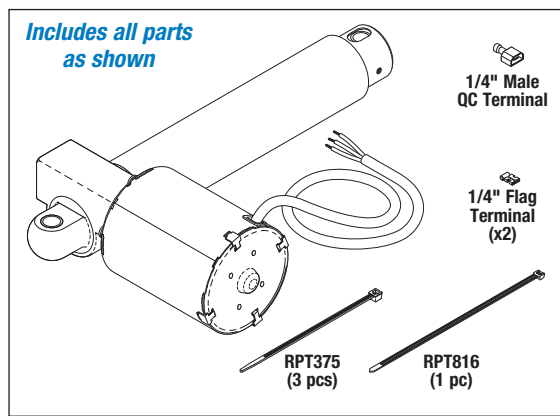

RPI Part #MIA217
OEM Part #002-0497-00

ACTUATOR (BASE)

- 2.7A@115VAC
- Also available:
 Capacitor (35 μ F; 370VAC, 50/60 Hz) (RPI Part #MIC220)

***Models:** 75L (411), 411 (75L) & 411

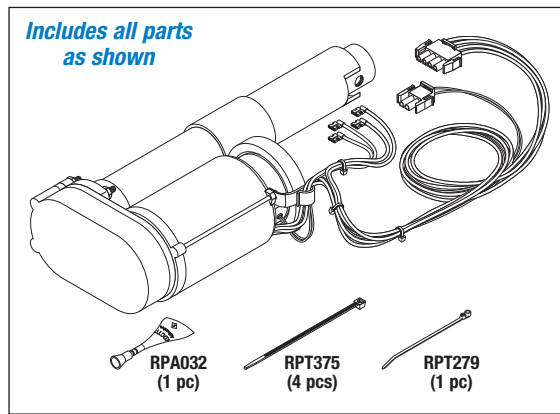

RPI Part #MIA216
OEM Part #002-0496-00 & 002-0564-06

ACTUATOR (BACK)

- 2.7A@115VAC
- Also available:
 Capacitor (41-53 μ F; 330VAC) (RPI Part #MIC183),
 Brake & Coupler Kit (RPI Part #MIK167), and
 Limit Switch (RPI Part #MIS175)

Fits: Back Section

***Models:** Evolution 75, 75L (411), 411 (75L), 411 & 419

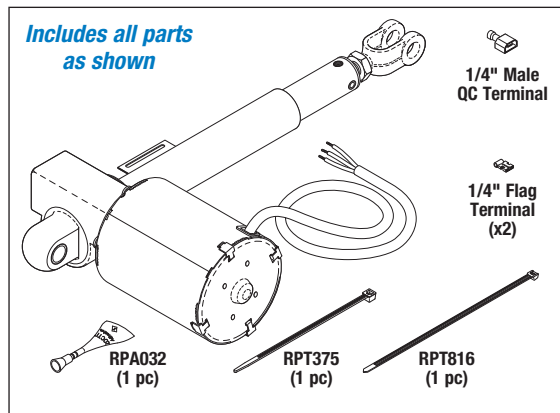

Tables & Chairs (Exam/Surgical)

Models: Evolution 75, 75L, 100, 200, 300, 400 and 600 Series (continued)

* See www.rpiparts.com for the Model/Serial # breakdown by part.

RPI Part #MIA272
OEM Part #002-0564-08



ACTUATOR (FOOT)

- 2.7A@115VAC
- Also available:
Capacitor (25-36 μ F; 330VAC) (RPI Part #MIC182),
Brake & Coupler Kit (RPI Part #MIK167), and
Limit Switch (RPI Part #MIS175)

Fits: Foot Section

*Model: 419

Includes all parts
as shown

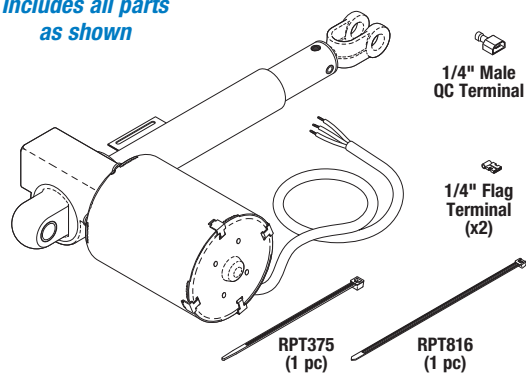

RPI Part #MIA164
OEM Part #002-0215-00/
002-0590-00/002-0564-06

BACK & FOOT ACTUATOR

- 2.7A@115VAC
- Also available:
Capacitor (25-36 μ F; 330VAC) (RPI Part #MIC182),
Capacitor (41-53 μ F; 330VAC) (RPI Part #MIC183), and
Brake & Coupler Kit (RPI Part #MIK167)

Fits: Table Back and/or Foot Section

*Models: 411 & 419

Includes all parts
as shown

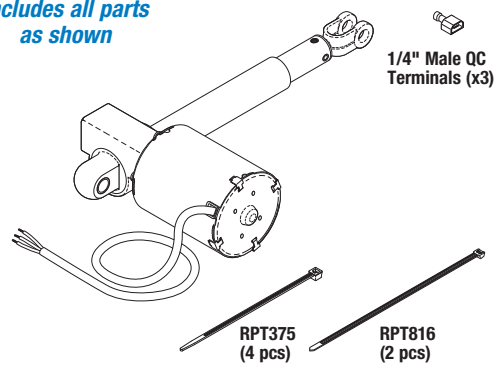

RPI Part #MIA165
OEM Part #002-0214-00/
002-0562-00

BASE & TILT ACTUATOR

- 2.7A@115VAC
- Also available:
Capacitor (54-64 μ F; 330VAC) (RPI Part #DEC610),
Capacitor (25-36 μ F; 330VAC) (RPI Part #MIC182),
Brake & Coupler Kit (RPI Part #MIK167),
Base Limit Switch (RPI Part #MIS175),
Gas Cylinder (RPI Part #MIC176),
Support Bar (RPI Part #MIT177), and
Pry Bar (RPI Part #MIT178)

Fits: Table Base and/or Tilt Section

*Models: 411 & 419

Includes all parts
as shown

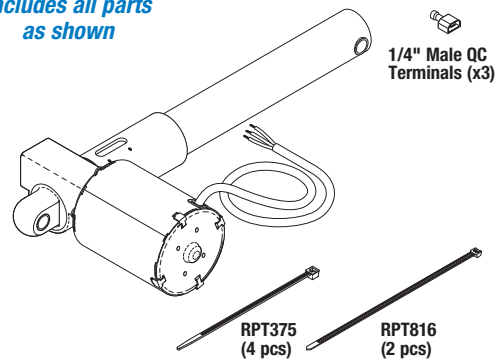

RPI Part #MIP191
OEM Part #015-0440-00

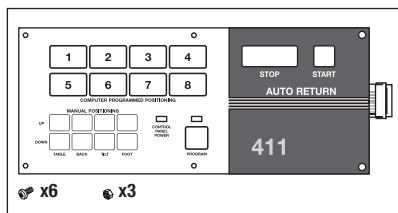

PROGRAM PANEL

- Size: 5.25" x 12.60"
- Includes: Metal mounting plate and mounting hardware
- Also available: Interface PC board (RPI Part #MIB192)

Fits: Side Console

*Model: 411

RPI Part #MIB192
OEM Part #015-0347-03

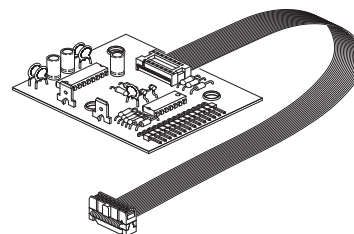

INTERFACE PC BOARD

- Also available: Program Panel (RPI Part #MIP191)

Fits: Program Panel

*Model: 411

Tables & Chairs (Exam/Surgical)

Models: Evolution 75, 75L, 100, 200, 300, 400 and 600 Series (continued)

* See www.rpiparts.com for the Model/Serial # breakdown by part.

RPI Part #DEC610
OEM Part #015-0437-00

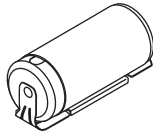

CAPACITOR
(54-64 µF; 330VAC)

- Size: 1.81" OD x 3.38" lg.
- Includes: Capacitor Mounting Bracket (RPI Part #MIB186), and Capacitor Cap (RPI Part #MIC184)

Fits: Base Motor/Base/Tilt Actuator
***Models:** Evolution 75, 411, 415 & 419

RPI Part #MIC182
OEM Part #015-0437-04

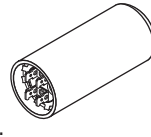

CAPACITOR
(25-36 µF; 330VAC)

- Size: 1.44" dia. x 3.38" lg.
- Dual .25" Tabs
- Also available: Capacitor Mounting Bracket (RPI Part #MIB186) and Capacitor Cap (RPI Part #MIC185)

Fits: Chassis
***Models:** 75L (411), 411 (75L), 411 & 419

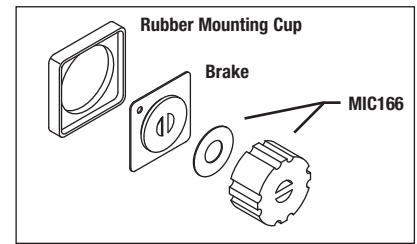

RPI Part #MIK167
OEM Part #016-0237-00 (Brake only)

BRAKE & COUPLER KIT

- This kit is for **Motion Systems** version motor only. (For **Fasco** version motor use **Motor Coupler** (RPI Part #MIC166)).
- Includes: Brake, Rubber Mounting Cup, and Motor Coupler (RPI Part #MIC166)
- Included in: Back & Foot Actuator (RPI Part #MIA164), Base & Tilt Actuator (RPI Part #MIA165), Actuator (Foot) (RPI Part #MIA215), Actuator (Back) (RPI Part #MIA216), Actuator (Tilt) (RPI Part #MIA218), and Actuator (Foot) (RPI Part #MIA272)

Fits: Only fits Back & Foot Actuator and Base & Tilt Actuator manufactured by **Motion Systems**
***Models:** Evolution 75, 75L (411), 411 (75L), 411 & 419

RPI Part #MIC019
OEM Part #002-0044-00/015-0437-07

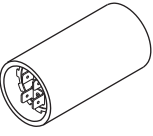

CAPACITOR
(124-149 µF; 250VAC, 60 Hz.)

- Size: 1.81" dia. x 4.38" lg.
- Dual .25" tabs

Fits: Motor and Pump Assembly
***Models:** Evolution 75, 105, 106, 107, 111, 112, 113, 114, 115, 116, 117, 119, 305, 307, 311, 317, 318 & 319

RPI Part #MIC183
OEM Part #015-0437-03

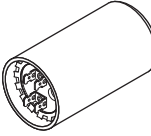

CAPACITOR
(41-53 µF; 330VAC)

- Size: 1.81" dia. x 3.38" lg.
- Dual .25" Tabs
- Also available: Capacitor Mounting Bracket (RPI Part #MIB186), and Capacitor Cap (RPI Part #MIC184)

Fits: Chassis
***Models:** Evolution 75, 75L (411), 411 (75L), 411, 413 & 419

RPI Part #MIC020
OEM Part #002-0043-00

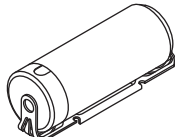

CAPACITOR KIT
(64-77µF; 330VAC)

- Size: 1.81" OD x 3.38" lg.
- Includes: Capacitor Mounting Bracket (RPI Part #MIB186), and Capacitor Cap (RPI Part #MIC184)

Fits: Motor and Pump Assembly
***Models:** Evolution 75, 106, 111, 112, 113, 114, 117, 119 & 306

RPI Part #MIC219
OEM Part #015-0437-02

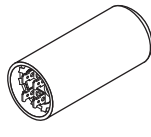

CAPACITOR
(36-43 µF; 330VAC)

- Start capacitor
- Size: 1.44" dia. x 3.38" lg.
- Dual .25" Tabs
- Also available: Capacitor Mounting Bracket (RPI Part #MIB186), and Capacitor Cap (RPI Part #MIC185)

Fits: Chassis
***Models:** Evolution 75, 75L (411), 405, 411 (75L), 411, 414, 416, 417, 418, 419 & 491

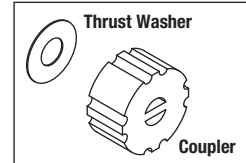

RPI Part #MIC166
OEM Part #016-0509-00

MOTOR COUPLER

- This kit is for **Fasco** version motor only. (For **Motion Systems** version motor use **Brake & Coupler Kit** (RPI Part #MIK167)).
- Size: 1.00" OD x .48" thk.
- Couples 5/16" dia. slotted shafts
- Includes: Coupler and Thrust Washer
- Also included in: Brake & Coupler Kit (RPI Part #MIK167)

Fits: Only fits Back & Foot Actuator and Base & Tilt Actuator manufactured by **Fasco**
***Models:** 75L (411), 411 (75L), 411 & 419

RPI Part #MIC126
OEM Part #002-0638-00

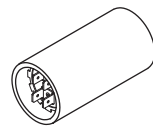

CAPACITOR
(145-174 µF, 330VAC)

- Size: 2.06" dia. x 4.38" tall
- Dual .25" tabs

Fits: Chassis
***Models:** 105, 107, 305 & 307

RPI Part #MIC220
OEM Part #015-0723-03

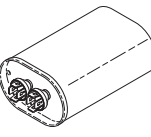

CAPACITOR
(35 µF; 370VAC, 50/60 Hz)

- Size: 2.79" x 1.79" (oval case) x 3.88" lg.
- Quad .25" Tabs

Fits: Chassis
***Models:** 75L (411), 411 (75L) & 411

RPI Part #MIC185
OEM Part #015-0413-00



CAPACITOR CAP

- Size: 1.44" dia.
- Fits:** Capacitor (1.44" dia.)

***Models:** 105, 107, 305, 307, 405, 411, 414, 417, 418, 419 & 491

RPI Part #MIC184
OEM Part #015-0413-01



CAPACITOR CAP

- Size: 1.81" dia.
- Fits:** Capacitor (1.81" dia.)
- *Models:** Evolution 75, 105, 106, 107, 111, 112, 113, 114, 115, 116, 117, 119, 305, 306, 307, 311, 317, 318, 319, 411, 413, 415 & 419

RPI Part #MIB186
OEM Part #015-0412-00

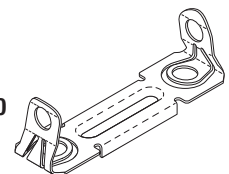

CAPACITOR MOUNTING BRACKET

- Fits:** Chassis
- *Models:** Evolution 75, 105, 106, 107, 111, 112, 113, 114, 115, 116, 117, 119, 305, 306, 307, 311, 317, 318, 319, 411, 413, 414, 415, 417, 418, 419 & 491

* See www.rpiparts.com for the Model/Serial # breakdown by part.

RPI Part #MIC284
OEM Part #002-0911-04



HAND CONTROL (BASIC)

- Includes all parts as shown
- Fits:** Front or Rear Connection Port
- *Models:** Evolution 75 & 230

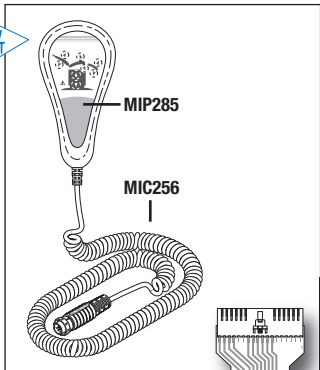

Just Need The Panel?

RPI Part #MIP285
OEM Part #015-1866-00



MEMBRANE PANEL

- Size: 2.47" x 5.05"; Adhesive backing



Also Available:

- COILED CORD (RPI Part #MIC256)
- HAND CONTROL HOLSTER KIT (RPI Part #MIK252)

RPI Part #MIC288
OEM Part #002-0911-01



HAND CONTROL (NON-PROGRAMMABLE)

- Includes all parts as shown
- Fits:** Front or Rear Connection Port
- *Models:** Evolution 75, 630 & 641

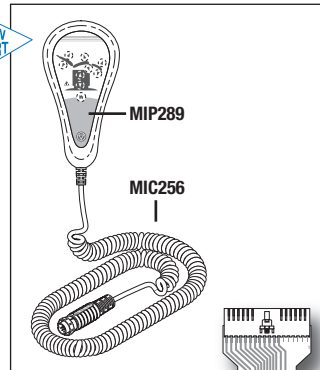

Just Need The Panel?

RPI Part #MIP289
OEM Part #015-1677-00



MEMBRANE PANEL

- Size: 2.47" x 5.05"; Adhesive backing



Also Available:

- COILED CORD (RPI Part #MIC256)
- HAND CONTROL HOLSTER KIT (RPI Part #MIK252)

RPI Part #MIC286
OEM Part #002-0911-02



HAND CONTROL (PROGRAMMABLE)

- Includes all parts as shown
- Fits:** Front or Rear Connection Port
- *Models:** Evolution 75, 630 & 641

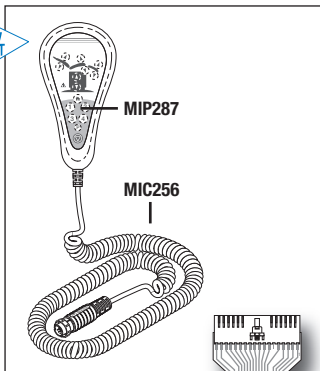

Just Need The Panel?

RPI Part #MIP287
OEM Part #015-1678-00



MEMBRANE PANEL

- Size: 2.47" x 5.05"; Adhesive backing

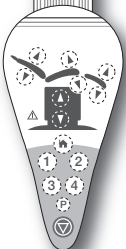

Also Available:

- COILED CORD (RPI Part #MIC256)
- HAND CONTROL HOLSTER KIT (RPI Part #MIK252)

RPI Part #MIC290
OEM Part #002-0911-05



HAND CONTROL (PROGRAMMABLE WITH HEATER)

- Includes all parts as shown
- Fits:** Front or Rear Connection Port
- *Model:** 630

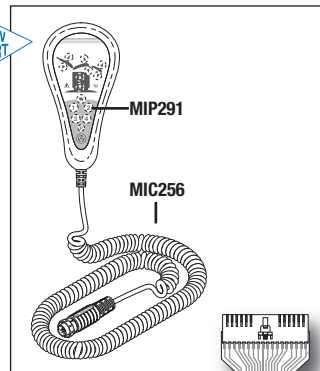

Just Need The Panel?

RPI Part #MIP291
OEM Part #015-1765-00



MEMBRANE PANEL

- Size: 2.47" x 5.05"; Adhesive backing



Also Available:

- COILED CORD (RPI Part #MIC256)
- HAND CONTROL HOLSTER KIT (RPI Part #MIK252)

Tables & Chairs (Exam/Surgical)

Models: Evolution 75, 75L, 100, 200, 300, 400 and 600 Series (continued)

* See www.rpiparts.com for the Model/Serial # breakdown by part.

RPI Part #MIC307
OEM Part #002-0624-00



HAND CONTROL

- Includes all parts as shown
- Fits:** Front or Rear Connection Port
- *Model:** 405

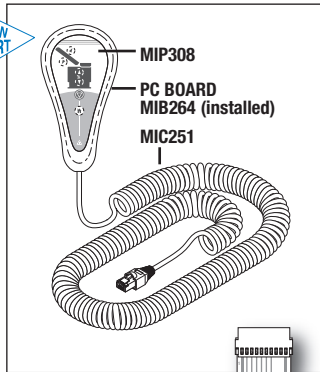

Just Need The Panel?

RPI Part #MIP308
OEM Part #015-1243-00



MEMBRANE PANEL

- Size: 2.47" x 5.05"; Adhesive backing



Also Available:

- PC BOARD (RPI Part #MIB264)
- COILED CORD (RPI Part #MIC251)
- HAND CONTROL HOLSTER KIT (RPI Part #MIK252)

RPI Part #MIC304
OEM Part #
029-0681-00 (Velcro Version)/
002-0409-00 (Clip On Version)



HAND CONTROL

- Includes options for both clip on and Velcro mounting.
- Includes all parts as shown
- Fits:** Hand Control
- *Model:** 405

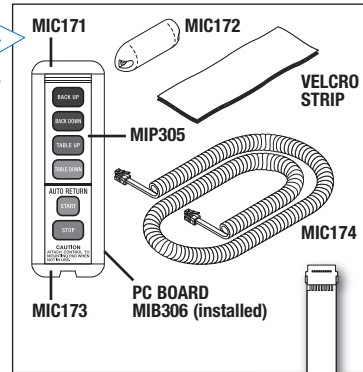

Just Need The Panel?

RPI Part #MIP305
OEM Part #015-0528-00



HAND CONTROL PANEL

- Size: 2.16" W x 8.28" lg.; Metal backing plate



Also Available:

- HAND CONTROL PC BOARD (RPI Part #MIB306)
- COILED CORD (RPI Part #MIC174)
- TOP END CAP (CLIP ON) (RPI Part #MIC171)
- TOP END CAP (VELCRO) (RPI Part #MIC172)
- BOTTOM END CAP (RPI Part #MIC173)

RPI Part #MIC282
OEM Part #002-0911-00/
002-0911-06



HAND CONTROL

- Includes all parts as shown
- Fits:** Front or Rear Connection Port
- *Models:** 223 & 623

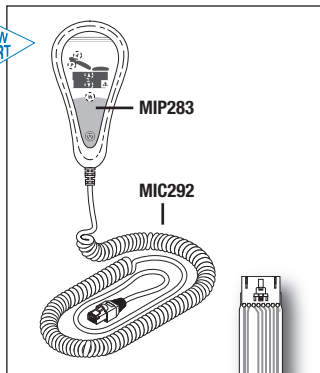

Just Need The Panel?

RPI Part #MIP283
OEM Part #015-1684-00



MEMBRANE PANEL

- Size: 2.47" x 5.05"; Adhesive backing



Also Available:

- COILED CORD (RPI Part #MIC292)
- HAND CONTROL HOLSTER KIT (RPI Part #MIK252)

RPI Part #MIC168
OEM Part #
9A73001 (Velcro Version)/
053-0412-00 (Clip On Version)



HAND CONTROL

- Includes options for both clip on and Velcro mounting.
- Includes all parts as shown
- Fits:** Hand Control
- *Model:** 411

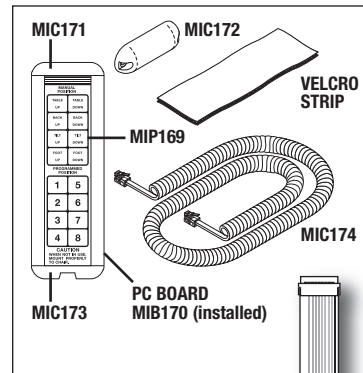

Just Need The Panel?

RPI Part #MIP169
OEM Part #015-0502-00



HAND CONTROL PANEL

- Size: 2.15" x 8.31"; Metal Backing Plate



Also Available:

- HAND CONTROL PC BOARD (RPI Part #MIB170)
- COILED CORD (RPI Part #MIC174)
- TOP END CAP (CLIP ON) (RPI Part #MIC171)
- TOP END CAP (VELCRO) (RPI Part #MIC172)
- BOTTOM END CAP (RPI Part #MIC173)

* See www.rpiparts.com for the Model/Serial # breakdown by part.

RPI Part #MIC277
OEM Part #002-0499-00



HAND CONTROL (NON-PROGRAMMABLE)

- Includes all parts as shown

Fits: Chassis Connector

***Models:** Evolution 75, 411, 411 (75L) & 75L (411)

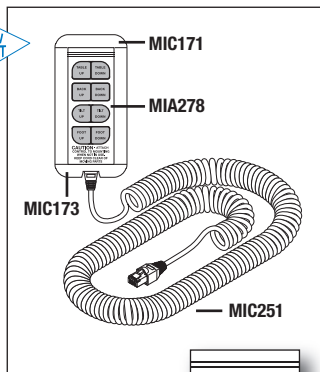

Just Need The Panel?

RPI Part #MIA278
OEM Part #015-0995-00



CONTROL PANEL ASSEMBLY

- Size: 2.12" x 5.11"

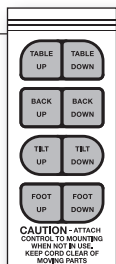

Also Available:

- COILED CORD (RPI Part #MIC251)
- TOP END CAP (CLIP ON) (RPI Part #MIC171)
- BOTTOM END CAP (RPI Part #MIC173)

RPI Part #MIC248
OEM Part #002-0604-00

HAND CONTROL (PROGRAMMABLE)

- Includes all parts as shown

***Models:** Evolution 75, 411 (75L) & 75L (411)

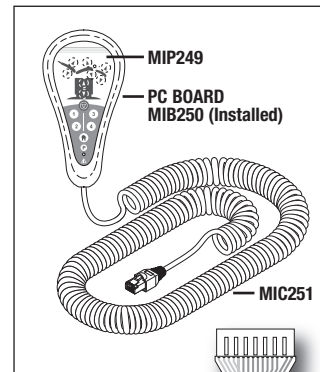

Just Need The Panel?

RPI Part #MIP249
OEM Part #015-1116-00

MEMBRANE PANEL (PROGRAMMABLE)

- Size: 2.47" x 5.05"; Adhesive backing



Also Available:

- PC BOARD (RPI Part #MIB250)
- COILED CORD (RPI Part #MIC251)
- HAND CONTROL HOLSTER KIT (RPI Part #MIK252)

RPI Part #MIC280
OEM Part #002-0578-00



HAND CONTROL (PROGRAMMABLE)

- Includes all parts as shown

Fits: Chassis Connector

***Models:** Evolution 75, 411 (75L) & 75L (411)

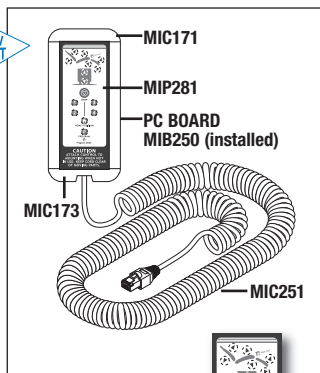

Just Need The Panel?

RPI Part #MIP281
OEM Part #015-1127-00



HAND CONTROL PANEL

- Size: 2.16" x 5.56"; Metal backing plate



Also Available:

- PC BOARD (RPI Part #MIB250)
- COILED CORD (RPI Part #MIC251)
- TOP END CAP (CLIP ON) (RPI Part #MIC171)
- BOTTOM END CAP (RPI Part #MIC173)

RPI Part #MIC262
OEM Part #002-0603-00

HAND CONTROL (NON-PROGRAMMABLE)

- Includes all parts as shown

***Models:** Evolution 75, 411 (75L) & 75L (411)

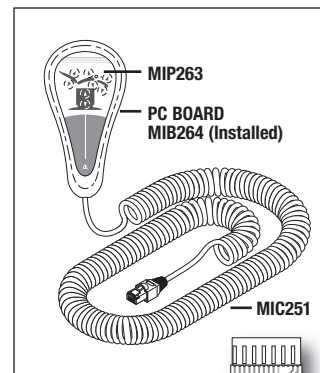

Just Need The Panel?

RPI Part #MIP263
OEM Part #015-1134-00, 015-1288-00, 015-1438-00

MEMBRANE PANEL (NON-PROGRAMMABLE)

- Size: 2.47" x 5.05"; Adhesive backing



Also Available:

- PC BOARD (RPI Part #MIB264)
- COILED CORD (RPI Part #MIC251)
- HAND CONTROL HOLSTER KIT (RPI Part #MIK252)

Tables & Chairs (Exam/Surgical)

Models: Evolution 75, 75L, 100, 200, 300, 400 and 600 Series (continued)

*** See www.rpiparts.com for the Model/Serial # breakdown by part.**

SERVICE TIP!

Allow your customer to securely store, and easily access any of the hand controls.

Simply install an RPI Hand Control Holster Kit on the side rail of the exam chair, or on a wall near the chair.

This Kit includes everything you need to quickly mount the holster and/or the side rail bracket for your customer's convenience.

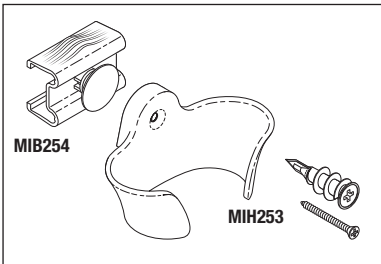

RPI Part #MIK252
OEM Part #002-1474-00

HAND CONTROL HOLSTER KIT

- Upgrade kit for all tables using teardrop style hand control
- Accommodates side rail or wall mount attachment
- Includes: Hand Control Holster (RPI Part #MIH253), Side Rail Hand Control Bracket (RPI Part #MIB254), and mounting hardware

Fits: Side Rail and Wall Mount

***Models:** Evolution 75, 223, 230, 405, 411, 419, 623, 630 & 641

RPI Part #MIH253
OEM Part #002-1472-00

HAND CONTROL HOLSTER

- Material: Black ABS
- Includes: Mounting hardware
- Included in: Hand Control Holster Kit (RPI Part #MIK252)
- Also available: Side Rail Hand Control Bracket (RPI Part #MIB254)

Fits: Side Rail and Wall Mount

***Models:** Evolution 75, 223, 230, 405, 411, 419, 623, 630 & 641

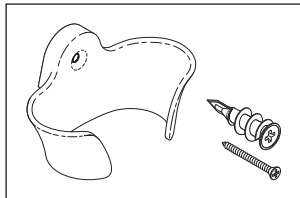

RPI Part #MIB254
OEM Part #053-1388-00 & 053-2268-00-312

SIDE RAIL HAND CONTROL BRACKET

- Material: Black ABS
- Included in: Hand Control Holster Kit (RPI Part #MIK252)
- Also available: Hand Control Holster (RPI Part #MIH253)

Fits: Side Rail

***Models:** Evolution 75, 223, 230, 405, 411, 419, 623, 630 & 641

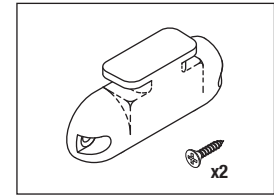
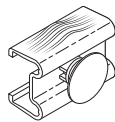

RPI Part #MIC171
OEM Part #053-0412-00

TOP END CAP (CLIP ON)

- Includes: Mounting hardware
- Included in: Hand Control (RPI Part #'s MIC168 and MIC304), Hand Control (Non-Programmable) (RPI Part #MIC277), and Hand Control (Programmable) (RPI Part #MIC280)

Fits: Hand Control

***Models:** Evolution 75, 75L (411), 405, 411 & 411 (75L)

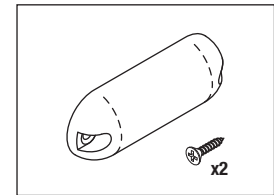

RPI Part #MIC172
OEM Part #053-0257-00

TOP END CAP (VELCRO)

- Includes: Mounting hardware
- Included in: Hand Control (RPI Part #'s MIC168 and MIC304)

Fits: Hand Control

***Models:** Evolution 75, 75L (411), 319, 405, 411, 411 (75L) & 417

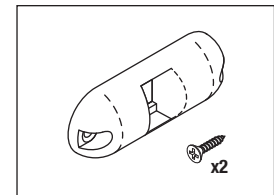

RPI Part #MIC173
OEM Part #053-0256-00

BOTTOM END CAP

- Includes: Mounting hardware
- Included in: Hand Control (RPI Part #'s MIC168 and MIC304), Hand Control (Non-Programmable) (RPI Part #MIC277), and Hand Control (Programmable) (RPI Part #MIC280)

Fits: Hand Control

***Models:** Evolution 75, 75L (411), 319, 405, 411, 411 (75L) & 417

NOTES:

* See www.rpiparts.com for the Model/Serial # breakdown by part.



RPI Part #MIB306
OEM Part #002-0347-06

HAND CONTROL PC BOARD

- Included in: Hand Control (RPI Part #MIC304)
- Also available:
Coil Cord (RPI Part #MIC174), and Membrane Panel (RPI Part #MIP305)

Fits: Hand Control
***Model:** 405

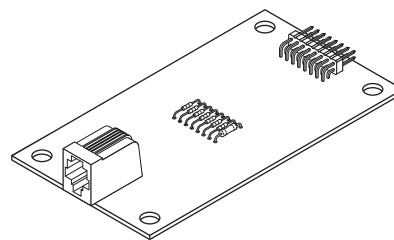

RPI Part #MIB309
OEM Part #015-1173-00

CONTROL INLET PCB

- Also available:
Coiled Cord (RPI Part #MIC251) and Coiled Cord (Foot Control) (RPI Part #MIC293)

Fits: Chassis
***Models:** Evolution 75, 75L (411), 411 & 411 (75L)

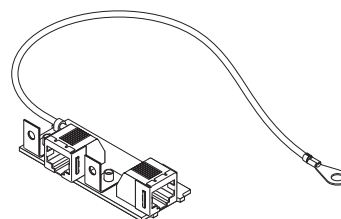

RPI Part #MIB170
OEM Part #002-0347-02

HAND CONTROL PC BOARD

- Included in:
Hand Control (RPI Part #MIC168)
- Also available: Coil Cord (RPI Part #MIC174), and Hand Control Panel (RPI Part #MIP169)

Fits: Hand Control
***Model:** 411

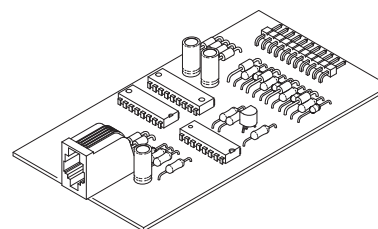

RPI Part #MIB250
OEM Part #015-1066-00

PC BOARD

- Includes: Mounting hardware
- Included in: Hand Control (Programmable) (RPI Part #'s MIC248 and MIC280)
- Also available: Membrane Panel (Programmable) (RPI Part #MIP249), and Coiled Cord (RPI Part MIC251)

Fits: Hand Control Case
***Models:** Evolution 75, 75L (411) & 411 (75L)

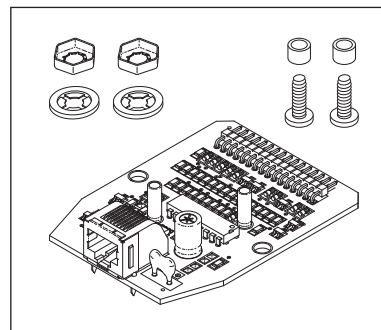

RPI Part #MIB264
OEM Part #015-1291-00

PC BOARD

- Includes: Mounting hardware
- Included in: Hand Control (Non-Programmable) (RPI Part #MIC262)
- Also available: Membrane Panel (Non-Programmable) (RPI Part #MIP263) and Coiled Cord (RPI Part #MIC251)

Fits: Hand Control Case
***Models:** Evolution 75, 405, 411, 75L (411) & 411 (75L)

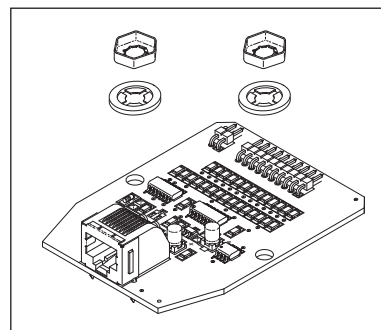

Tables & Chairs (Exam/Surgical)

Models: Evolution 75, 75L, 100, 200, 300, 400 and 600 Series (continued)

* See www.rpiparts.com for the Model/Serial # breakdown by part.

RPI Part #MIC256
OEM Part #015-1675-00

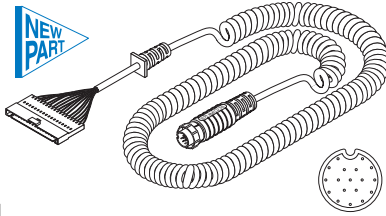

COILED CORD

- Material: 18 conductor cable; black jacket; 18 pin connectors; over-molded strain relief
- Length: ~14 ft. extended
- Included in: Hand Control (Basic) (RPI Part #MIC284), Hand Control (Programmable) (RPI Part #MIC286), Hand Control (Non-Programmable) (RPI Part #MIC288), and Hand Control (Programmable With Heater) (RPI Part #MIC290)
- Also available: Connection Port Harness (Short) (RPI Part #MIH257) and Connection Port Harness (Long) (RPI Part #MIH258)

Fits: Hand Control and Foot Control

***Models:** Evolution 75, 230, 630, 641, 646 & 647

RPI Part #MIC292
OEM Part #015-1675-04

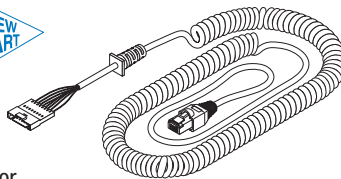

COILED CORD

- Material: 8 conductor cable, black jacket, RJ45 connector with protective boot and 8 pin Molex connector
- Length: ~25 ft. extended
- Included in: Hand Control (RPI Part #MIC282)

Fits: Hand Control and Foot Control

***Models:** 223 & 623

RPI Part #MIC293
OEM Part #015-1785-00

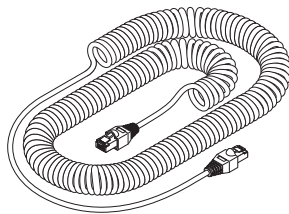

COILED CORD (FOOT CONTROL)

- Material: 8 conductor cable, black jacket, RJ45 connector with protective boots
- Length: ~25 ft. extended
- One end of coiled cord is 12" long to easily fit through the foot switch case

Fits: Foot Control

***Models:** 223 & 623

RPI Part #MIC273
OEM Part #002-0048-00

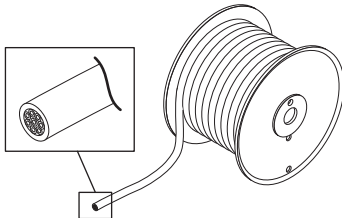

FOOT CONTROL CORD

- Sold by the foot (reel not included)
- 8 conductor #18 AWG 19/30 strands
- Colors: Black, Red, Orange, Green, Blue, White, White/Black and Red/Black
- Grey TPR jacket, UL 20234, 176°F (80°C), 600V; .54" OD cord

Fits: Foot Control and Base Assembly

***Models:** Evolution 75, 105, 106, 107, 111, 112, 113, 114, 116, 117, 119, 305, 306, 307, 311, 317, 318 & 319

RPI Part #MIC251
OEM Part #015-0839-00

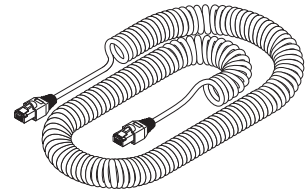

COILED CORD

- Material: 8 conductor cable, black jacket, RJ45 connectors with protective boots
- Length: ~25 ft. extended
- Included in: Hand Control (Programmable) (RPI Part #'s MIC248 and MIC280), Hand Control (Non-Programmable) (RPI Part #'s MIC262 and MIC277), and Hand Control (RPI Part #MIC307)

Fits: Hand Control and Foot Control

***Models:** Evolution 75, 75L (411), 319, 405, 411, 411 (75L) & 419

RPI Part #MIC174
OEM Part #015-0505-03

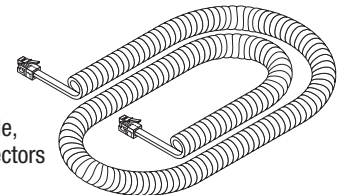

COILED CORD

- Material: 4 conductor cable, black jacket, RJ-22 connectors
- Length: ~12 ft. extended
- Included in: Hand Control (RPI Part #'s MIC168 and MIC304)

Fits: Hand Control

***Models:** 405, 411 & 417

RPI Part #MIH257
OEM Part #002-1110-00

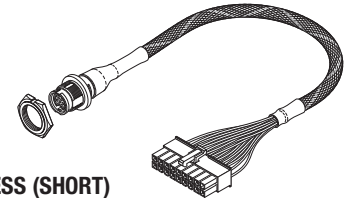

CONNECTION PORT HARNESS (SHORT)

- Material: 18 conductor cable; black braided sleeve; (2) 18 Pin connectors
- Length: 13"
- Also available: Connection Port Harness (Long) (RPI Part #MIH258), and Coiled Cord (RPI Part #MIC256)

Fits: Hand Control and Foot Control

***Models:** Evolution 75, 230, 630 & 641

RPI Part #MIH258
OEM Part #002-1110-01

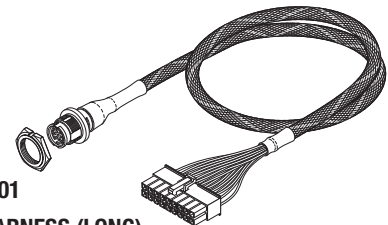

CONNECTION PORT HARNESS (LONG)

- Material: 18 conductor cable; black braided sleeve; (2) 18 Pin connectors
- Length: 26"
- Also available: Connection Port Harness (Short) (RPI Part #MIH257), and Coiled Cord (RPI Part #MIC256)

Fits: Hand Control and Foot Control

***Models:** Evolution 75, 230, 630 & 641

Tables & Chairs (Exam/Surgical)

Models: Evolution 75, 75L, 100, 200, 300, 400 and 600 Series (continued)

* See www.rpiparts.com for the Model/Serial # breakdown by part.

RPI Part #MIC088
OEM Part #016-0240-00

LOCKING GAS CYLINDER

- Extension Force = 400 N (90 LBF)
- Also available: Actuator Cap Kit (RPI Part #MIK189) and Plunger (RPI Part #MIP188)

Fits: Back Assembly

***Models:** 222, 404 & 622

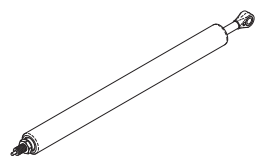

RPI Part #MIC298
OEM Part #016-0356-00

GAS CYLINDER

- Extension Force = 1058 N (238 LBF)
- See **Model** below for quantities required for each model serial number

Fits: Power Base Assembly

Model: 414-001: All Serial #'s, Serial #BM1000 to BM1050 requires (1) Cylinder, Serial #BM1051 to present requires (2) Cylinders

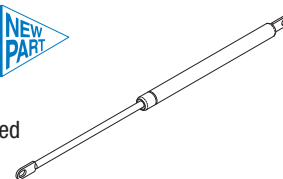

RPI Part #MIC176
OEM Part #002-0213-00, 016-0236-00 & 016-0236-01 ("Double Gas Cylinder" design)

GAS CYLINDER

- Extension Force = 1058 N (238 LBF)
- **Caution** - Use the Support Bar (RPI Part #MIT177) to support the Table Top and the Pry Bar (RPI Part #MIT178) to safely compress the Gas Cylinder during the removal and installation process.
- This Gas Cylinder replaces the "Double Gas Cylinder" design used in older versions of these tables

Fits: Middle Member and Chassis Assembly

***Models:** 411, 413 & 419

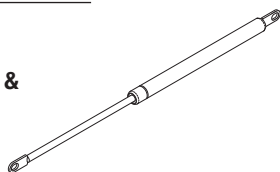

RPI Part #MIC299
OEM Part #016-1625-00

LOCKING GAS CYLINDER

- Extension Force = 475 N (107 LBF)

Fits: Back Assembly

***Models:** 222 & 622

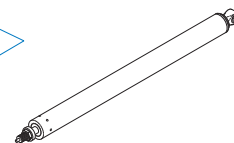

RPI Part #MIC300
OEM Part #016-1017-00

LOCKING GAS CYLINDER

- Extension Force = 400 N (90 LBF)

Fits: Back Assembly

***Models:** 204 & 604

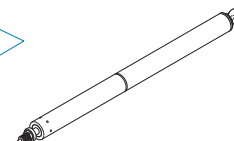

RPI Part #MIC187
OEM Part #016-1024-00

LOCKING GAS CYLINDER

- Extension Force = 475 N (107 LBF)
- Also available: Actuator Cap Kit (RPI Part #MIK189) & Plunger (RPI Part #MIP188)

Fits: Back Assembly

***Models:** 222 & 622

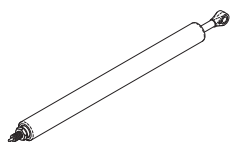

RPI Part #MIC310
OEM Part #002-1065-00

GAS CYLINDER SET

- Extension Force = 100 N (225 LBF) each cylinder
- Includes: (2) Gas Cylinders and (4) Safety Clips

Fits: Scissor Assembly

***Models:** Evolution 75, 230, 630, 641 & 647

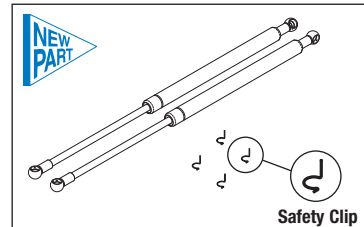

RPI Part #MIT177
OEM Part #051-0412-00

SUPPORT BAR

- Size: 1" x 14-1/2" x 5/8" thk.
- Material: Nickel plated steel
- Use to support the weight of the table top when replacing the base actuator and the Gas Cylinder.

***Models:** 411 & 419

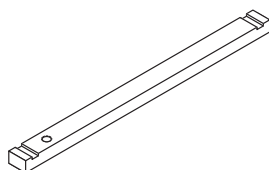

RPI Part #MIT178
OEM Part #051-0413-00

PRY BAR

- Size: 1-1/4" x 18" x 1/2" thk.
- Material: Nickel plated steel
- Use to compress the gas cylinder during removal and replacement.

Fits: Middle Member Assembly

***Models:** 411 & 419

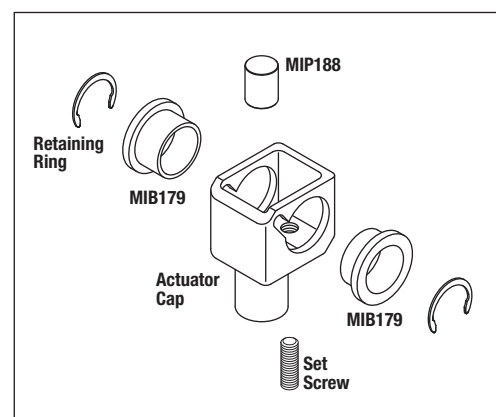
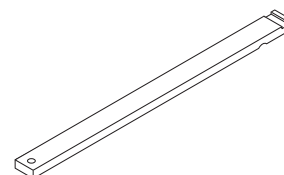

RPI Part #MIK189
OEM Part #020-0052-00, 020-0052-03 (Actuator Cap only), 040-0250-26 (Set Screw only) & 042-0066-00 (Retaining Ring only)

ACTUATOR CAP KIT

- Includes: Plunger (RPI Part #MIP188), Set Screw, (2) Pivot Bushing (RPI Part #MIB179) and (2) 3/4" Crescent Retaining Rings
- Also available: Locking Gas Cylinder (RPI Part #'s MIC088 & MIC187)

Fits: Back Assembly

***Models:** 222, 404 & 622

RPI Part #MIP188
OEM Part #053-0247-00

PLUNGER

- Solid plastic construction for added durability.

Fits: Actuator Cap

***Models:** 222, 404 & 622



RPI Part #MIB179
OEM Part #053-0246-00

PIVOT BUSHING

- 2 per package

Fits: Actuator Cap

***Models:** 222, 404 & 622



Call Us Toll-Free Monday–Friday, 8:00 AM–4:30 PM (Pacific Time), (800) 221-9723

Tables & Chairs (Exam/Surgical)

Models: Evolution 75, 75L, 100, 200, 300, 400 and 600 Series (continued)

*** See www.rpiparts.com for the Model/Serial # breakdown by part.**

RPI Part #MIR125
OEM Part #015-0023-00

RELAY

- Contact Rating: 25A@120VAC, 50/60 HZ; SPDT
- Coil: 120VAC; 290Ω
- Screw Terminals
- Fits:** Motor/Pump Base
- *Models:** 106 & 111

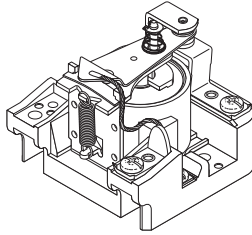

RPI Part #MIR017
OEM Part #002-0041-00 / 015-0061-00

TIME DELAY RELAY KIT

- 1A@120VAC/DC
- Preset: .20 sec. delay
- 1/4" Tabs
- Includes wire assemblies
- Fits:** Cylinder Solenoids
- *Models:** Evolution 75, 106, 111, 112, 113, 114, 116, 117, 119, 306, 311, 317, 318 & 319

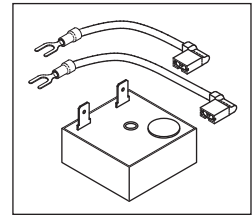

RPI Part #MIR018
OEM Part #015-0374-00

AUTO RETURN & INTERLOCK RELAY

- Contact Rating: 13A@120VAC; 10A@28VDC
- Coil: 120VAC
- Fits:** Control Box
- *Models:** 111, 112, 113, 114, 117 & 317

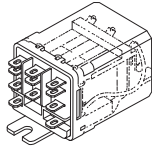

RPI Part #MIR024
OEM Part #002-0171-00

CONTROL PANEL RELAY

- 8A@120V
- 3/16" Tabs
- Fits:** Control Box
- *Model:** 115

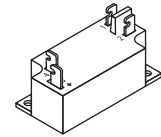

RPI Part #TUS009
OEM Part #015-0650-03

POWER SWITCH

- Rocker switch (On-Off), Legend: I/O; Green lens
- 16A@125/250VAC; DPST
- Panel Cutout: 1.185" x .874"; 1/4" Tabs
- Fits:** Main Housing
- *Models:** 222, 223, 622 & 623

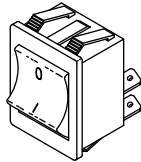

RPI Part #MIS175
OEM Part #015-0476-00 & 015-0430-00

LIMIT SWITCH

- 0.1 A@125VAC
- 3/16" Tabs
- Fits:** Column Assembly and Base Actuator
- *Models:** Evolution 75, 75L (411), 411, 411 (75L), 413, 415 & 419

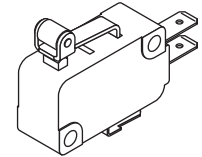

RPI Part #MIS009
OEM Part #015-0381-00

RETURN LIMIT SWITCH

- 10A@125/250VAC
- 1/4" Tabs
- Fits:** Base/Tilt Actuator
- *Models:** 111, 112, 113, 114 & 117

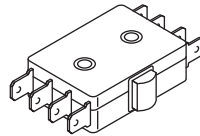

RPI Part #MIS127
OEM Part #015-0425-00

LIMIT SWITCH

- 15A@125/250VAC; SPDT
- 3/16" Tabs
- Fits:** Chassis
- *Models:** Evolution 75, 111, 119, 311, 319, 411, 414 & 419

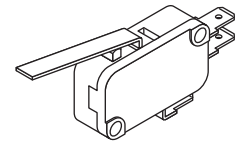

RPI Part #MIS016
OEM Part #015-0421-00 / 015-0381-00

RETURN LIMIT SWITCH

- 20A@125/250VAC; DPDT
- 1/4" Tabs
- Fits:** Column Assembly and Base Actuator
- *Models:** 111, 112, 113, 114, 117 & 317

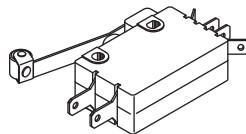

RPI Part #MIS255
OEM Part #015-1055-00 / 62977400

LIMIT SWITCH

- Momentary (on - off)
- 0.1A@125VAC, SPDT
- 3/16" Tabs
- Panel cutout: 1.125" x .550"
- *Models:** Evolution 75, 75L (411), 222, 223, 230, 411, 411 (75L), 622, 623, 630, 641, 646 & 647

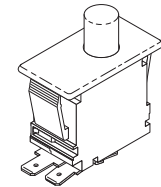

RPI Part #MIS026
OEM Part #015-0422-00

RETURN LIMIT SWITCH

- 15A@125-250VAC
- 3/16" Tabs
- Fits:** Tilt Actuator
- *Models:** 117, 317 & 405

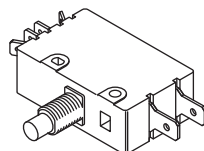

RPI Part #MIS259
OEM Part #015-1024-00

LIMIT SWITCH

- 15A@277 VAC; SPDT; 3/16" Tabs
- Fits:** Pan Switch Bracket
- *Models:** Evolution 75, 75L (411) & 411 (75L)

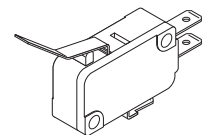

* See www.rpiparts.com for the Model Serial # breakdown by part.

RPI Part #MIA302
OEM Part #015-1758-00



SWITCH ASSEMBLY (UPHOLSTERY HEATER)

- Momentary 3A@125/250VAC; SPDT with 9" lg. cable and (4) 1/4" male fully insulated QC terminals
- Illuminated green lens; 12 VDC lamp
- Panel cut-out: 7/8" dia.
- Includes: Mounting hardware

Fits: Chassis

***Models:** 604, 622 & 623

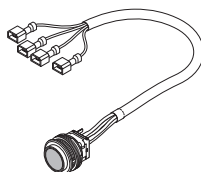

RPI Part #MIA303
OEM Part #015-1759-00



SWITCH ASSEMBLY (DRAWER HEATER)

- 3A@125/250 VAC; DPST with 20-1/2" lg. cable with (2) 1/4" male fully insulated QC terminals, and (2) 1/4" female fully insulated flag QC terminals
- Illuminated white lens; 110V Neon
- Panel cut-out: 7/8" dia.
- Includes: Mounting hardware

Fits: Chassis

***Models:** 204, 222, 223, 604, 622 & 623

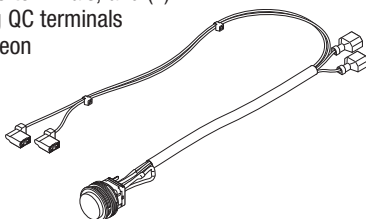

RPI Part #MIS015
OEM Part #002-0101-00 / 015-0072-00

MICROSWITCH

- 15A@125/250VAC; 1/2A@125 VDC; 1/4A@250 VDC
- Includes: Switch and (2 pcs) 3/16" QD terminal (RPI Part #RPT257)
- 3/16" Tabs

Fits: Foot Control and Front Panel

***Models:** 105, 106, 107, 117, 222, 305, 306, 307, 405, 413, 415 & 622

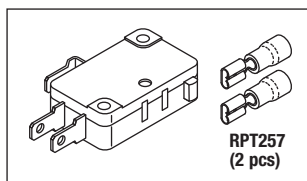

RPI Part #MIS023
OEM Part #002-0087-00

FOOT CONTROL SWITCH

- 10A@125/250VAC; N.O.; 1/4" Tabs

Fits: Foot Switch

***Model:** 115

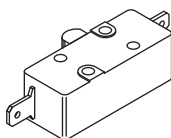

RPI Part #MIS011
OEM Part #015-0424-00

AUTO RETURN SWITCH (GREEN)

- Momentary push button switch; N.O.
- Non-lighted green pushbutton
- 10A@125/250VAC; SPST; 1/4" Tabs

Fits: Control Box

***Models:** 111,112, 113, 114, 117 & 317

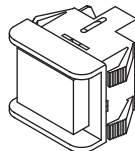

RPI Part #MIS012
OEM Part #015-0376-00

STOP SWITCH (RED)

- Momentary push button switch; N.C.
- Non-lighted red lens
- 10A@125/250 VAC; SPST; 1/4" Tabs

Fits: Control Box

***Models:** 111, 112, 113, 114, 117 & 317

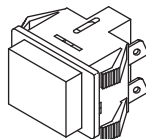

RPI Part #MIS128
OEM Part #015-0650-00

HEATER SWITCH

- Rocker switch (On-Off), Legend: I/O
- 20A@125/250VAC; DPST
- Illuminated red lens
- Panel cut-out: 1.118" x .906"
- 1/4" Tabs

Fits: Chassis

***Models:** 100, 104, 105, 305, 307, 404 & 405

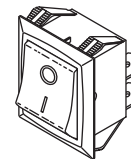

RPI Part #MIS013
OEM Part #002-0113-00

HEATER SWITCH (RED)

- Rocker switch (On-Off); SPST
- Illuminated red light panel
- 12A@125VAC; 6A@250VAC
- 1/4" tabs

Fits: Control Box

***Model:** 105

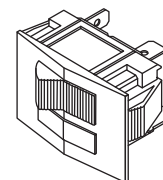

RPI Part #MIS014
OEM Part #002-0114-00

HEATER SWITCH (RED)

- Momentary push button switch; N.O.
- Illuminated red lens
- 10A@125/250VAC; DPST
- 1/4" Tabs

Fits: Control Box

***Models:** 100, 104, 105 & 107

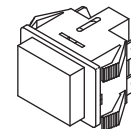

RPI Part #MIS025
OEM Part #015-0408-00

ROCKER SWITCH

- ON/OFF/MOM. ON; DPDT
- 15A@125VAC; 10A@250VAC
- 1/4" Tabs

Fits: Control Box

***Models:** 117 & 317

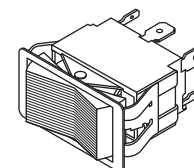

RPI Part #MIS021
OEM Part #002-0085-00

REED SWITCH ASSEMBLY

- SPST; N.O.
- 10W Max., .5A@250VAC
- 1/4" Tabs

Fits: Cylinder

***Model:** 115

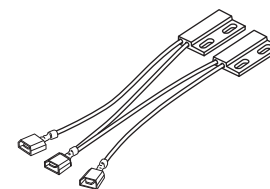

RPI Part #MIS022
OEM Part #002-0086-00

REED SWITCH ASSEMBLY

- SPST; N.O.
- 10W Max., .5A@240VAC
- 1/4" Tabs

Fits: Cylinders

***Model:** 115

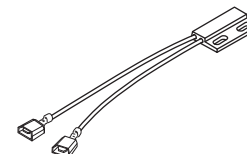

Tables & Chairs (Exam/Surgical)

Models: Evolution 75, 75L, 100, 200, 300, 400 and 600 Series (continued)

* See www.rpiparts.com for the Model Serial # breakdown by part.

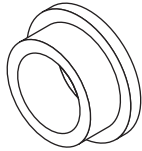

RPI Part #RXB035
OEM Part #016-0131-21

FLANGE BEARING

- 12 per package
 - .375" ID x .501" OD x .69" dia. x .062" Flange
 - Material: Oil embedded bronze
- Fits:** Foot, Seat, Back and Column Assemblies
***Models:** Evolution 75, 230 & 630

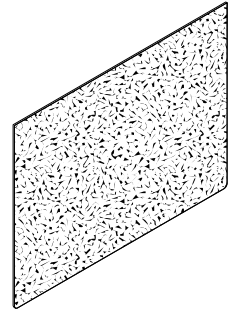

RPI Part #MIC296
OEM Part #053-0048-00

STEP COVER (BLACK)

- Material: Black slip-resistant tread with PSA backing
 - Size: 12" x 16"
- Fits:** Step Assembly
***Model:** 100

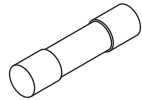

RPI Part #RXF036
OEM Part #015-0346-40

**FUSE (6.3A, 250V)
5mm x 20mm TIME DELAY**

- 5 per package
 - Type: Ceramic
- Fits:** Power Inlet Module
***Models:** Evolution 75, 230, 630, 641 & 647

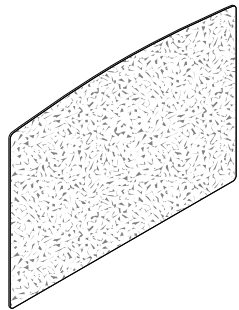

RPI Part #MIC295
OEM Part #053-0848-00

STEP COVER (GREY)

- Material: Grey slip-resistant tread with PSA backing
 - Size: 12" x 17"
- Fits:** Step Assembly
***Models:** 100, 104 & 304

RPI Part #RPC822
OEM Part #054-0085-04, 054-0085-05,
054-0067-00, 054-0074-00 & 054-0145-00

SOUND DAMPING COMPOSITE

- Size: 12" x 12" x 1/2" thk.
 - Acoustic foam with vinyl barrier core and adhesive backing
 - Cut to size
- Fits:** Back, Foot and Base Chassis Assemblies
***Models:** 411 & 419

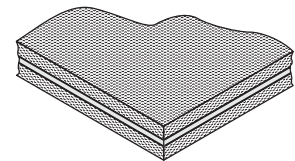

RPI Part #RPT279
OEM Part # (No OEM Part # Available)

CABLE TIE (8" BLACK)

- 25 per package
 - 3/16" x 8" lg.
- Fits:** Actuator

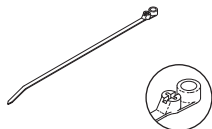

With Mounting Hole

RPI Part #RPT375
OEM Part # (No OEM Part # Available)

CABLE TIE (12" BLACK)

- 25 per package
 - Size: 3/16" w x 12" lg.
- Fits:** Actuator



RPI Part #RPT816
OEM Part #015-0472-00

CABLE TIE (14" BLACK)

- 10 per package
 - Size: 5/16" w x 14" lg.
- Fits:** Actuator



**New
Parts
to fit**

Midmark® • Ritter® Exam Tables and Chairs!



RPI Part #MIA315
OEM Part #016-0358-00/
002-0391-00/002-0564-10



ACTUATOR (BACK & TILT)

- 2.2A @ 115VAC
- Includes: (2 pcs) Cable Tie (12" Black) (RPI Part #RPT375), (2 pcs) Cable Tie (14" Black) (RPI Part #RPT816), and (3) QC terminal (1/4" male, fully insulated)
- Also available: Capacitor (36-43µf; 330VAC) (RPI Part #MIC219) and Brake & Coupler Kit (RPI Part #MIK167)

Fits: Seat Section

Models: 414, 416 & 417 (see Note below)



RPI Part #MIA316
OEM Part #016-0338-00/
002-0296-00/002-0565-10



ACTUATOR (BASE)

- 3.2A @ 115VAC
- Includes: (4 pcs) Cable Tie (12" Black) (RPI Part #RPT375), (1 pc) Threadlocker 262 (RPI Part #RXA007), and (3) QC terminal (1/4" male, fully insulated)
- Also available: Capacitor (50µf, 370VAC) (RPI Part #MIC321) and Brake & Coupler Kit (RPI Part #MIK167)

Fits: Base Section

Models: 414 & 417 (see Note below)



RPI Part #MIC321
OEM Part #015-0438-06/
002-1058-00



CAPACITOR (50µf, 370 VAC, 50/60 Hz)

- Run capacitor
- Size: 2.00" dia. x 3.75" lg.
- Quad 1/4" Tabs
- Includes mounting bracket

Fits: Back Section

Models: 414 & 417 (see Note below)

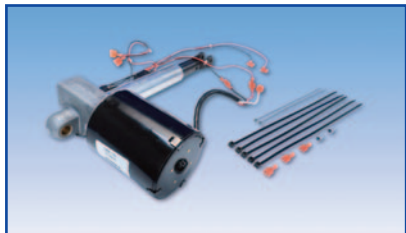

RPI Part #MIA317
OEM Part #002-0727-00



ACTUATOR (BACK & TILT)

- 2.2A @ 115VAC
- Includes: (2) Limit Switch (RPI Part #MIS175), (2 pcs) Cable Tie (8" Grey) (RPI Part #RPT397), (4 pcs) Cable Tie (12" Black) (RPI Part #RPT375), (2 pcs) Wire Nut (RPI Part #RPT017), (3 pcs) QC Terminal (1/4" Female) (RPI Part #RPT472), and pre-installed modified wire harness
- Also available: Capacitor (36-43 µf; 330VAC) (RPI Part #MIC219) and Brake & Coupler Kit (RPI Part #MIK167)

Fits: Seat Section

Models: 416 & 417 (see Note below)



RPI Part #MIA313
OEM Part #016-0214-00/
002-0596-02/002-0437-00



ACTUATOR (BASE)

- 2.2A @ 115VAC
- Includes: (2 pcs) Cable Tie (12" Black) (RPI Part #RPT375), (2 pcs) Cable Tie (14" Black) (RPI Part #RPT816), (3) #6 spade terminal, and (1 pc) Threadlocker 262 (RPI Part #RXA007)
- Also available: Capacitor (41-53µf; 330VAC) (RPI Part #MIC183) and Brake & Coupler Kit (RPI Part #MIK167)

Fits: Base Section

Model: 413 & 415 (see Note below)



RPI Part #MIA314
OEM Part #002-0596-02/
016-0213-00/002-0435-00



ACTUATOR (SEAT)

- 2.2A @ 115VAC
- Includes: (2 pcs) Cable Tie (14" Black) (RPI Part #RPT816), (2 pcs) Cable Tie (12" Black) (RPI Part #RPT375), (3) QC terminal (1/4" male, fully insulated), (3) QC terminal (1/4" female, fully insulated), and (1 pc) Threadlocker 262 (RPI Part #RXA007)
- Also available: Capacitor (41-53µf; 330VAC) (RPI Part #MIC183), Limit Switch (RPI Part #MIS175) and Brake & Coupler Kit (RPI Part #MIK167)

Fits: Seat Section

Models: 413 & 415 (see Note below)

Note: Not all parts fit all Serial #'s for the models stated. Please see www.rpiparts.com for Serial # breakdown of the models these parts fit.



RPI Part #MIA311
**OEM Part #016-0230-00/
002-0344-00/029-0682-00**



ACTUATOR (BASE)

- 2.2A @ 115VAC
- Includes: (2 pcs) Cable Tie (12" Black) (RPI Part #RPT375), (2 pcs) Cable Tie (14" Black) (RPI Part #RPT816), and (3) QC terminal (1/4" male, fully insulated)
- Also available: Capacitor (36-43µf; 330VAC) (RPI Part #MIC219) and Brake & Coupler Kit (RPI Part #MIK167)

Fits: Base Section
Model: 405 (see Note below)



RPI Part #MIA312
**OEM Part #016-0331-00/
002-0345-00/029-0683-00**



ACTUATOR (BACK)

- 1.5A @ 115VAC
- Includes: (2 pcs) Cable Tie (12" Black) (RPI Part #RPT375), (2 pcs) Cable Tie (14" Black) (RPI Part #RPT816), and (3) QC terminal (1/4" male, fully insulated)
- Also available: Capacitor (36-43µf; 330VAC) (RPI Part #MIC219) and Brake & Coupler Kit (RPI Part #MIK167)

Fits: Back Section
Model: 405 (see Note below)

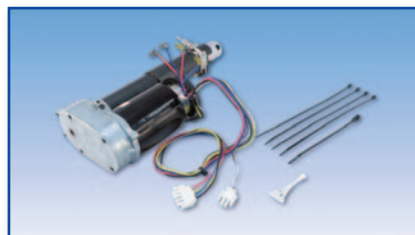

RPI Part #MIA274
OEM Part #002-0627-00



ACTUATOR (BASE)

- 3.2A @ 115VAC
- Includes: Limit Switch (RPI Part #MIS175), (4 pcs) Cable Tie (12" Black) (RPI Part #RPT375), (1 pc) Cable Tie (8" Black) (RPI Part #RPT279), and (1 pc) Threadlocker 242 (RPI Part #RPA032)
- Also available: Capacitor (35µf; 370VAC, 50/60 Hz) (RPI Part #MIC220)

Fits: Base Section
Model: 419 (see Note below)



RPI Part #MIC318
OEM Part #9A93001



HAND CONTROL

- Includes: Hand Control Panel (RPI Part #MIP319), Hand Control PC Board (RPI Part #MIB320), Coiled Cord (RPI Part #MIC174), Top End Cap (RPI Part #MIC172), Bottom End Cap (RPI Part #MIC173), and pressure sensitive adhesive velcro strip

Fits: Chassis Connector
Models: 414, 416 & 417 (see Note below)

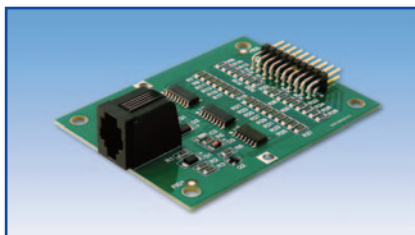

RPI Part #MIB320
OEM Part #015-0568-00



HAND CONTROL PC BOARD

- Included in: Hand Control (RPI Part #MIC318)
- Also available: Hand Control Panel (RPI Part #MIP319) and Coiled Cord (RPI Part #MIC174)

Fits: Hand Control
Models: 414, 416 & 417 (see Note below)



RPI Part #MIP319
OEM Part #015-0546-00

HAND CONTROL PANEL

- Size: 2.16" x 6.61"; Metal backing plate
- Included in: Hand Control (RPI Part #MIC318)
- Also available: Hand Control PC Board (RPI Part #MIB320), Coiled Cord (RPI Part #MIC174), Top End Cap (RPI Part #MIC172), and Bottom End Cap (RPI Part #MIC173)

Fits: Hand Control
Models: 414, 416 & 417 (see Note below)



RPI Part #MIS325
OEM Part #015-0543-00/015-1587-00



SWITCH

- Rocker switch (On-Off), Legend: I/O
- 16A @ 125VAC; 10A @ 250VAC; SPST
- 1/4" Tabs
- Panel cutout: 1.125" x .550", .025" - .187" Thk panel

Fits: Seat Section
Model: 414, 416 & 417



RPI Part #MIS326
OEM Part #015-0635-00



LIMIT SWITCH

- 11A @ 125/250 VAC; SPDT
- 3/16" Tabs

Fits: Base Section
Models: 414 & 417 (see Note below)

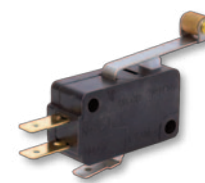

RPI Part #MIC294
OEM Part #015-1000-00/
015-1293-00/015-1396-00/
015-1342-00



MAIN COILED HARNESS

- Connects main PC board to back and tilt actuators.
- Material: 13 conductor cable; black jacket; all connectors and terminals pre-installed
- Includes: (4 pcs) loop clamps
- Depending on the model, not all connectors will be used
- Also available: Sensor Coiled Harness (RPI Part #MIC297)

Fits: Base Section

Models: 411, 419 & Evolution 75 (see Note below)

RPI Part #RXM085
OEM Part #015-1653-00/
002-10454-00



POWER ENTRY MODULE

- 10A @ Selectable 115 VAC/230 VAC, 3/16" tabs
- For use with C13 power cords
- Fuses not included, accepts up to 2 ea 1/4" dia. x 1-1/4" lg. or 5mm x 20mm fuses
- Panel cutout: 1.06" x 2.20", .031" - .079" panel Thk

Fits: Chassis

Models: 230, 630, 641, 647 & Evolution 75 (see Note below)

RPI Part #MIC297
OEM Part #015-1118-00

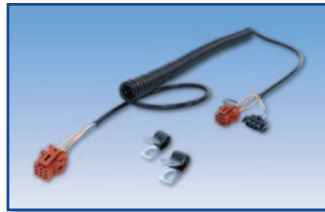

SENSOR COILED HARNESS

- Connects main PC board to back and tilt position sensors.
- Material: 7 conductor cable; black jacket; all connectors pre-installed
- Includes: (2 pcs) loop clamps
- Also available: Main Coiled Harness (RPI Part #MIC294)

Fits: Base Section

Models: 411, 419 & Evolution 75 (see Note below)

RPI Part #RXS113
OEM Part #015-0007-04



HARNESS STRAP

- 6 per package
- Size: 2-3/4" long, black nylon
- Mounts in a 1/4" dia. hole x 3/32" Thk max panel
- Use to strap cables, wires, and water and air supply lines

Fits: Chassis

Models: 222, 223, 622 & 623 (see Note below)

RPI Part #MIC339
OEM Part #015-0066-11/
015-0066-04



HOSPITAL GRADE POWER CORD (15A @ 125VAC, 10 ft.)

- 10 ft. lg. with jacket stripped 8"; Gray
- 12/3 SJT, 105° C; 15A @ 125 VAC
- Plug Type: NEMA 5-15 hospital grade
- Includes: (1 pc) Strain Relief Bushing (RPI Part #RXB112), (4 pcs) Cable Tie (8" Black) (RPI Part #RPT279), (6 pcs) Cable Tie (8" Black) (RPI Part #RPT085), connector housing with (3) crimp terminal, (1) #10 ring terminal, and (2) #6 spade terminal

Fits: Chassis

Models: 411, 414, 416 & 417

RPI Part #RXB112
OEM Part #015-0002-05
Industry Part #SR 31-2



STRAIN RELIEF BUSHING

- 3 per package
- Accommodates .425" - .475" dia. round cord
- Mounting hole: 7/8" dia.
- Included in: Hospital Grade Power Cord (15A @ 125VAC, 10 ft.) (RPI Part #MIC339)

Fits: Chassis

Models: 411, 416 & 417

ALSO AVAILABLE:

• **HOSPITAL GRADE POWER CORD (15A @ 125VAC, 10 ft.)**
RPI Part #RPC260
OEM Part # (No OEM Part # Available)

• **FUSE (6.3A, 250V)**
RPI Part #RXF036
OEM Part #015-0346-40

• **STRAIN RELIEF BUSHING PLIERS**
RPI Part #RPT172
OEM Part # (No OEM Part # Available)

• **HOSPITAL GRADE POWER CORD (15A @ 125VAC, 8 ft.)**
RPI Part #RPC554
OEM Part # (No OEM Part # Available)

• **FUSE HOLDER**
RPI Part #RPH674
OEM Part #015-1259-02

• **GAS CYLINDER**
RPI Part #MIC298
OEM Part #016-0356-00

NEW ACTUATORS, HAND CONTROL, AND MORE!

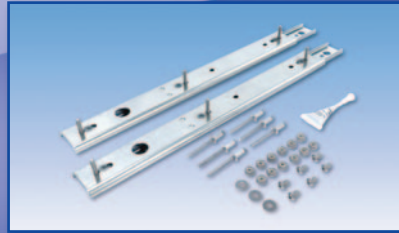
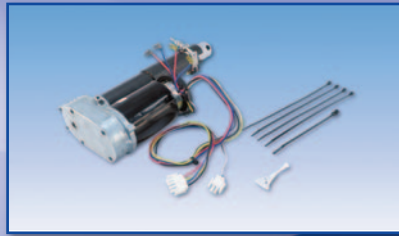

New Parts to fit Midmark® • Ritter® Exam Tables and Chairs!

ADDRESS SERVICES REQUESTED

replacement parts industries, inc.
 625 Cochran Street • Simi Valley, California • 93065



RESORTED STANDARD
 U.S. POSTAGE PAID
 VAN NUYS, CA
 PERMIT NO. 2399

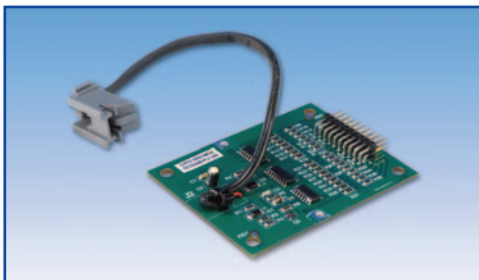

RPI Part #MIB322
OEM Part #015-0568-01/002-0347-05

FOOT CONTROL PC BOARD

- Also available: Coiled Cord (RPI Part #MIC174)

Fits: Foot Control

Models: 414, 416 & 417



RPI Part #MIK336
OEM Part #002-0868-02

SLIDE KIT

- Replacement slides for the foot extension
- Includes: Two slides, all necessary mounting hardware and (1 pc) Threadlocker (242) (RPI Part #RPA032)

Fits: Seat Section Weldment

Models: 414, 416 & 417

Tables & Chairs (Exam/Surgical)

Models: FL Type 75C-75F, PA Type 75C-75F & PB Type 75C-75F

RPI Part #RCA061
OEM Part #144648

METERING SCREW ASSEMBLY

- Brass
- Includes metering screw with O-rings (RPI Part #RPO306 & RPO307)

Fits: Solenoid Valve

Model: FL, PA & PB **Type:** 75C-75F
& All models using old style Solenoid Coil



RPI Part #RCK066
OEM Part #144741

SOLENOID BODY KIT

- Includes plunger, spring, spanner nut, and O-ring

Fits: Solenoid Valve

Model: FL, PA & PB **Type:** 75C-75F

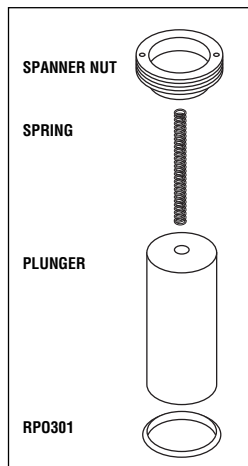

RPI Part #RCM065
OEM Part #141573

MOTOR MOUNT

- 2 per package
- 1/4-20 UNC x 23/64" Lg. x 2

Fits: Motor

Model: FL, PA & PB **Type:** 75C-75F

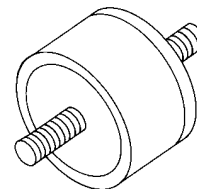

RPI Part #RCC062
OEM Part #171421

MOTOR STARTING CAPACITOR

- 110-125VAC, 60 Hz., 108-130 MFD

Fits: Motor

Model: FL, PA & PB **Type:** 75C-75F

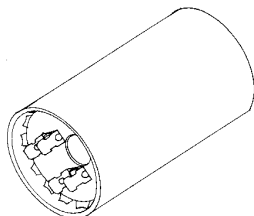

RPI Part #RCP063
OEM Part #C-3872

ROLL PIN

- 12 per package
- 1/8" Dia. x 5/8" Lg.

Fits: Tilt Cylinder

Model: FL, PA & PB **Type:** 75C-75F

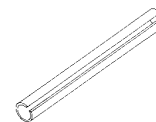

RPI Part #RCC601
OEM Part #14183

SOLENOID COIL

- 49.78 Ω min; 55.02 Ω max;
Coil Rating: 120VAC
- Coil: 1.265" OD x 1.335" long
with .50" dia. through hole
- Wire: 11" lg.

Fits: Solenoid Valve

Model: FL, PA & PB **Type:** 75C-75F

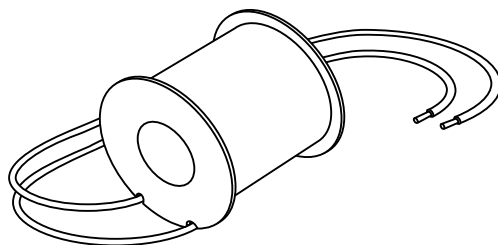

RPI Part #RCP072
OEM Part #425-A-13

STANDPIPE PACKING

Fits: Lift Tube

Model: FL, PA & PB **Type:** 75C-75F

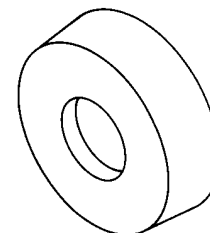

RPI Part #RCC602
OEM Part #143830

FOOT SWITCH CABLE

- Sold by the foot (Reminder: OEM's cable was 5 ft. in length)
- 7 conductor insulated cable; .53" OD; Jacket 16/7
- For connecting foot control to table

Model: FL, PA & PB **Type:** 75C-75F

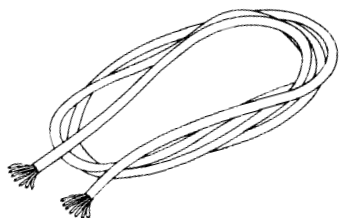

RPI Part #RCM064
OEM Part #155961

VIBRATION MOUNT

- 1/4-20 UNC x 23/64" Lg.

Fits: Motor

Model: FL, PA & PB **Type:** 75C-75F

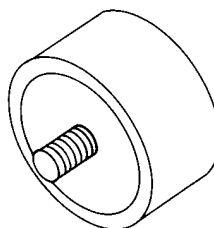

**If it's an RPI part,
it's a part you
can trust.**

Call Us Toll-Free Monday-Friday, 8:00 AM-4:30 PM (Pacific Time), (800) 221-9723

Tables & Chairs (Exam/Surgical)

Models: FL Type 75C-75F, PA Type 75C-75F & PB Type 75C-75F (continued)

RPI Part #RCS068
OEM Part #143923
UPPER LIMIT SWITCH
 Fits: Lift Structure
 Model: FL, PA & PB Type: 75C-75F

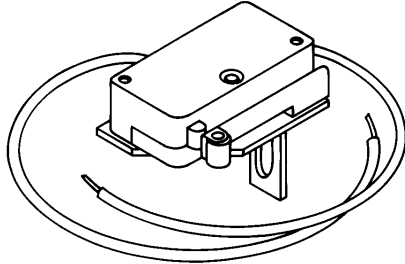

RPI Part #RCS607
OEM Part #10610/P-2400
PIVOT SCREW
 • 2 per package
 • Includes screw and #8 split lock washer
 Fits: Foot Switch Housing
 Model: FL, PA & PB Type: 75C-75F

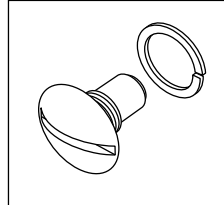

RPI Part #RPO301
OEM Part #C-5970
Industry Part #AS568-014
O-RING
 • 12 per package
 • .489" ID x .629" OD x .070" C/S
 • Material: Nitrile (Buna-N)
 • Duro: 70
 Fits: Solenoid Valve Plunger
 Model: FL, PA & PB Type: 75C-75F

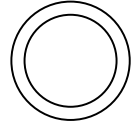

RPI Part #RCS069
OEM Part #155677
FILTER SCREEN
 • 6 per package
 • Brass
 Fits: Hose Assembly that attaches to Cylinder
 Model: FL, PA & PB Type: 75C-75F

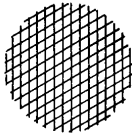

RPI Part #RCI067
OEM Part #108926
BRASS INSERT
 • 4 per package
 Fits: Hydraulic Tubing
 Model: FL, PA & PB Type: 75C-75F

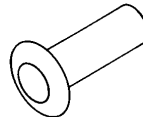

New RPI Part #RPO307
Old RPI Part #RC0040
OEM Part #P-12233
Industry Part #2-006
O-RING
 • 12 per package
 • .114" ID x .254" OD x .070" C/S
 • Material: EPDM
 • Duro: 70
 Fits: Solenoid Metering Screw
 Model: FL, PA & PB Type: 75C-75F



RPI Part #RCS070
OEM Part #155808
LOCK SCREW
 • 10-24 UNC-2A x 1"
 Fits: Yoke
 Model: FL, PA & PB Type: 75C-75F

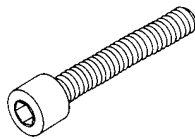

RPI Part #RCN059
OEM Part #C-6760
COMPRESSION NUT
 • 4 per package
 • 7/16-24
 Fits: 1/4" Hydraulic Tubing
 Model: FL, PA & PB Type: 75C-75F



O-Ring illustrations are actual size

NOTES:

Carbon Brush Reference Guide

Since brush size, structure and composition are critical for optimum performance, use exact replacements only.

Brushes warranted only for applications indicated in RPI catalog.

This chart is sorted by brush size.

RPI PART#	SIZE	RADIUS/BEVEL	SPRING LG.	SHUNT	END CAP	NOTES
RCB603	.093" x .250" x .500"	25°	None	None	None	
BDB002	.125" x .250" x .690"	None	1.28"	None	None	
RCB604	.128" x .256" x .531"	30°	None	None	None	
CAB021	.185" x .185" x .562"	.437" R	.62"	.62"	.28" dia.	
CAB083	.187" dia x.187" w/Flange	.140" R	None	None	None	Bullet Style
STB002	.187" x .187" x .437"	None	.94"	None	None	
CAB023	.187" x .187" x .560"	.750" R	1.25"	1.25"	.17" O.D.	
BDB001	.187" x .250" x .660"	None	1.00"	1.00"	None	
IEB015	.187" x .375" x .945"	.750" R	1.17"	1.17"	.46" dia.	
IEB010	.188" x .625" x .937"	.625" R@5°	1.13"	1.13"	.56" dia.	
BAB002	.196" x .236" x .469"	.562" R	1.13"	None	None	
BAB004	.196" x .236" x .568"	.500" R	1.75"	1.03"	.19" O.D.	
IEB008	.218" x .312" x .560"	.437" R	.99"	.99"	.32" x .39" dia.	
SRB005	.248" x .996" x 1.250"	1.000" R@20°	None	2.88"	None	#10 Spade Terminal Black Fiberglass Sleeving
BKB003	.249" x .375" x .797"	.719" R	1.17"	1.17"	.37" x .46" dia.	
CAB022	.250" x .250" x .450"	.625" R	.75"	.75"	.16" x .24" dia.	
BKB006	.250" x .250" x .500"	.438" R	.75"	.75"	.25" x .31" dia.	
CAB019	.250" x .250" x .650"	1.000" R	.75"	.75"	.31" dia.	
CAB020	.250" x .250" x .650"	.750" R	1.00"	1.00"	.25" O.D.	
CAB018	.250" x .250" x .657"	1.000" R	.88"	.88"	.38" dia.	
EMB001	.250" x .250" x .657"	.500" R	1.25"	1.25"	.31" dia.	
IEB024	.250" x .250" x .660"	.660" R	.94"	.94"	.25" O.D.	
BKB005	.250" x .250" x .750"	1.000" R	.75"	.75"	.15" x .25"	
IEB007	.250" x .250" x .800"	.375" R	2.19"	None	None	
EPB003	.250" x .312" x .675"	.500" R	.99"	.99"	.24" dia.	
EPB001	.250" x .312" x .860"	.500" R	1.32"	1.32"	.25" dia.	
EPB002	.250" x .312" x .860"	.500" R	1.27"	1.27"	.24" dia.	
IEB014	.250" x .375" x .750"	.875" R	1.35"	1.35"	.37" x .47" dia.	
DRB001	.250" x .375" x .817"	.625" R	1.25"	1.25"	.34" x .44" dia.	
BKB004	.250" x .375" X .875"	1.000" R	1.25"	1.25"	.37" x .42" dia.	
IEB013	.250" x .437" x .687"	.750" R	1.13"	1.13"	.38" x .42" dia.	Split Brush
SRB002	.250" x .437" x .720"	.844" R	.98"	.98"	.37" x .42" dia.	
SRB001	.250" x .500" x .845"	.875" R	1.06"	1.06"	.50" x .60" dia.	
IEB009	.250" x .625" x .990"	1.000" R	1.13"	1.13"	.62" x .66" dia.	
IEB011	.250" x .625" x 1.000"	1.000" R	1.38"	1.38"	.62" x .66" dia.	
SRB003	.250" x 1.208" x 1.250"	1.000" R@20°	None	2.88"	None	#10 Spade Terminal Red Fiberglass Sleeving
IEB012	.250" x 1.250" x 1.125"	1.125" R@5°	1.25"	1.25"	1.23" x 1.25" dia.	
BAB003	.252" x .315" x .898"	.562" R	1.75"	None	None	
BAB001	.252" x .390" x .866"	.937" R	None	2.13"	None	1/4" Quick Disconnect Flag With Interrupter
BAB005	.252" x .390" x .866"	.937" R	None	1.88"	None	1/4" Quick Disconnect Flag With Interrupter
BAB006	.252" x .392" x .875"	.937" R	None	1.69"	None	1/4" Quick Disconnect Flag
BAB007	.252" x .394" x .875"	.750" R	2.63"	1.94"	.33" O.D.	With Interrupter
CAB017	.281" x .281" x .670"	.500" R	1.13"	1.13"	.28" x .39" dia.	
BAB008	.315" x .787" x .984"	None	None	3.88"	None	1/4" Spade, Split Brush Red Top Pad, Sensor Wire
SRB004	.343" x .750" x .990"	.750" R	1.56"	1.56"	.74" x .82" dia.	Split Brush, Plastic Cap & Sensor Wire with Connector

Call Us Toll-Free Monday–Friday, 8:00 AM–4:30 PM (Pacific Time), (800) 221-9723

TIME SWITCH & TIMER REFERENCE GUIDE

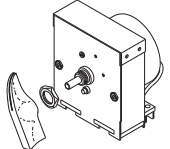
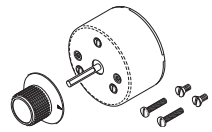
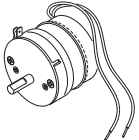
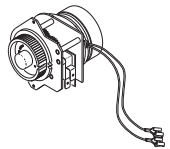
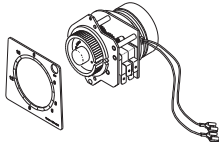
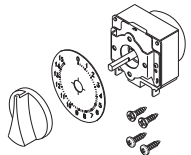
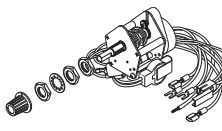
RPI PART #	TIME	MOTOR SPECS	SWITCH SPECS	ALERT	MOUNT	SHAFT	DIMENSIONS	
CAT071	3 min.	<ul style="list-style-type: none"> • 120VAC / 60HZ (CCW) • (2) each 1/4" Male Tab 	<ul style="list-style-type: none"> • 15A @ 120 VAC SPST • (2) each 1/4" Male Tab 	None	3/8-32 x 3/16" lg. Bushing	3/16" dia. x 7/16" lg.	2-9/16" x 3-3/16" x 1-3/4" DP.	
CAT045	5 min.	None	<ul style="list-style-type: none"> • 15A @ 120-240 VAC SPST • (2) each Terminal Screw 	None	2 Hole - #4-40 @ 1-1/8" apart	3/16" dia. x 1-1/16" lg. Double Flat	2-5/16" dia. x 1-1/4" DP.	
CAT067	5 min.	<ul style="list-style-type: none"> • 115VAC / 60HZ (CCW) 	<ul style="list-style-type: none"> • 15A @ 125-250 VAC SPST • (2) each 3/16" Male Tab 	None	2 Hole - #4-40 @ 1-1/8" apart	1/4" dia. x 3/4" lg. with Flat	2.0" dia. x 2.0" DP.	
CAT066	15 min.	<ul style="list-style-type: none"> • 110VAC / 60HZ (CCW) • (2) each 1/4" Female Terminal 	<ul style="list-style-type: none"> • (1) each SW = 15A @ 120-240 VAC SPST • 1/4" Male Tab 	None	2 Hole - #5-40 @ 3" apart	Push to Start	3-1/4" x 2-7/8" x 2-7/16" DP.	
CAT074	15 min.	<ul style="list-style-type: none"> • 110VAC / 60HZ (CCW) • (2) each 1/4" Female Terminal 	<ul style="list-style-type: none"> • (2) each SW = 15A @ 120-240 VAC SPST • 1/4" Male Tab 	None	2 Hole - .140" dia. @ 2-1/2" apart	Push to Start	3-1/4" x 2-7/8" x 2-7/16" DP.	
IET019	15 min.	None	<ul style="list-style-type: none"> • 20A @ 125VAC / 10A @ 250VAC SPST • (2) each 1/4" Male Tab 	Bell	2 Hole - #6-32 @ 1-1/8" apart	3/16" dia. x 11/16" lg. Double Flat	1-7/8" x 1-7/8" x 1-1/2" DP.	
MDT025	20 min.	<ul style="list-style-type: none"> • 115VAC / 60HZ (CCW) 	<ul style="list-style-type: none"> • (3) each SW = 10A @ 120 VAC SPST 	Buzzer	3/8-32 x 1/2" lg. Bushing	1/4" dia. x 9/16" lg. Double Flat	3-1/8" x 3-1/2" x 2-5/8" DP.	

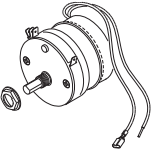
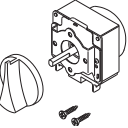
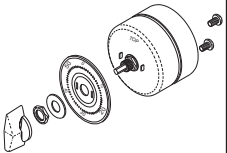
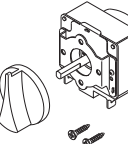
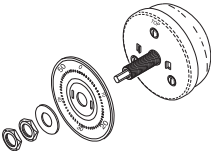
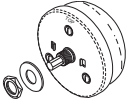
RPI PART #	TIME	MOTOR SPECS	SWITCH SPECS	ALERT	MOUNT	SHAFT	DIMENSIONS	
BDT017	30 min.	None	None	Bell	3/8-24 x 3/8" lg. Bushing	1/4" dia. x 13/16" lg. with Flat	2-11/16" dia. x 1-1/4" DP.	
CAT062	30 min.	<ul style="list-style-type: none"> • 115VAC / 60HZ (CCW) • (1) each 3/16" Female Terminal 	<ul style="list-style-type: none"> • 15A @ 125-250 VAC SPDT-DU • (4) each 3/16" Male Tab 	None	3/8-32 x 1/4" lg. Bushing	1/4" dia. x 3/8" lg. with Flat	2.0" dia. x 2.0" DP.	
CAT104	30 min.	None	<ul style="list-style-type: none"> • 20A @ 125VAC / 10A @ 250VAC SPST • (2) each 1/4" Male Tab 	Bell	2 Hole - #6-32 @ 1-1/8" apart	3/16" dia. x 11/16" lg. Double Flat	1-7/8" x 1-7/8" x 1-1/2" DP.	
AMT039	60 min.	None	<ul style="list-style-type: none"> • 20A @ 120-240 VAC SPST • (2) each Terminal Screw 	Bell	3/8-24 x 1/4" lg. Bushing	3/16" dia. x 7/16" lg. Double Flat	2-9/16" dia. x 1-3/4" DP.	
HBT002	60 min. with hold	None	<ul style="list-style-type: none"> • 20A @ 125VAC / 10A @ 250VAC SPST • (2) each 1/4" Male Tab 	Bell	2 Hole - #6-32 @ 1-1/8" apart	3/16" dia. x 11/16" lg. Double Flat	1-7/8" x 1-7/8" x 1-1/2" DP.	
MDT012	60 min.	None	None	Bell	3/8-24 x 1.0" lg. Bushing	3/16" dia. x 9/16" lg. Double Flat	2-11/16" dia. x 1-1/4" DP.	
PCT049	60 min.	None	None	Bell	3/8-24 x 9/32" lg. Bushing	1/4" dia. x 1/2" lg. with Flat	2-11/16" dia. x 1-1/4" DP.	

TIME SWITCH & TIMER REFERENCE GUIDE

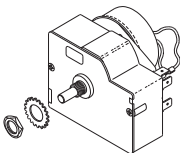
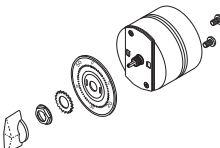
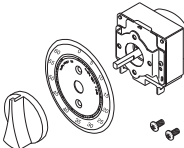
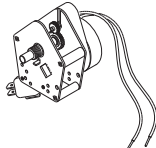
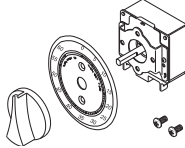
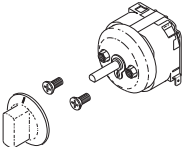
RPI PART #	TIME	MOTOR SPECS	SWITCH SPECS	ALERT	MOUNT	SHAFT	DIMENSIONS	
PCT081	60 min.	<ul style="list-style-type: none"> • 230VAC / 60HZ (CCW) • (2) each 1/4" Female Terminal 	<ul style="list-style-type: none"> • 7.5A @ 250VAC / 15A @ 125 VAC DPDT • (4) each 1/4" Male Tab 	None	3/8-32 x 1/4" lg. Bushing	1/4" dia. x 1/2" lg.	3-3/16" x 2-5/8" x 2-7/16" DP.	
RCT047	60 min.	None	<ul style="list-style-type: none"> • 20A @ 120-240 VAC SPST • (2) each Terminal Screw 	None	3/8-24 x 11/32" lg. Bushing	3/16" dia. x 3/8" lg. Double Flat	2-9/16" dia. x 1-9/16" DP.	
RCT048	60 min.	None	<ul style="list-style-type: none"> • 20A @ 125VAC / 10A @ 250VAC SPST • (2) each 1/4" Male Tab 	Bell	2 Hole - #6-32 @ 1-1/8" apart	3/16" dia. x 11/16" lg. Double Flat	1-7/8" x 1-7/8" x 1-1/2" DP.	
RCT049	60 min.	<ul style="list-style-type: none"> • 115VAC / 60HZ (CCW) 	<ul style="list-style-type: none"> • 15A @ 120 VAC SPST • 1/4" Male Tab 	None	3/8-32 x 1/4" lg. Bushing	1/4" dia. x 3/8" lg.	2-1/4" x 3-1/8" x 1-13/16" DP.	
RPT263	60 min.	None	<ul style="list-style-type: none"> • 20A @ 125VAC / 10A @ 250VAC SPST • (2) each 1/4" Male Tab 	None	2 Hole - #6-32 @ 1-1/8" apart	3/16" dia. x 11/16" lg. Double Flat	1-7/8" x 1-7/8" x 1-1/16" DP.	
TUT008	60 min.	None	<ul style="list-style-type: none"> • 16A @ 250VAC SPST • (2) each 1/4" Male Tab 	Bell	2 Hole - M4 @ 28.6mm (1.125") apart	6mm (.236") dia. x 24mm (.945") lg. with Flat	59mm (2.322") dia. x 48mm (1.890") DP.	
IET018	120 min.	None	<ul style="list-style-type: none"> • (2) each SW = 20A @ 120-240 VAC SPST • (4) each Terminal Screw 	Bell	3/8-24 x 1/4" lg. Bushing	3/16" dia. x 7/16" lg. Double Flat	2-9/16" dia. x 1-7/8" DP.	