

Models: EZ9, EZ9k, EZ10, EZ10k, 1730, 2340, 2540, 3850, & 3870 Series

LCD DISPLAYS, BOARDS, AND MORE TO FIT Tuttnauer Table Top Sterilizers!

TUTTNAUER

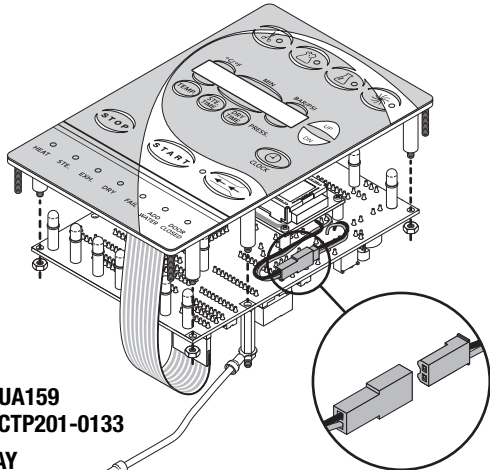

RPI Part #TUA159
OEM Part #CTP201-0133

LCD DISPLAY ASSEMBLY (BLUE)

- See **Important Note** below
- Includes all parts as shown

Fits: Front Panel

Models: 1730E/EK, 2340E/EA/EK/EKA, 2540E/EA/EK/EKA, 3850E/EA/EK/EKA, 3870E/EA/EK/EKA, EZ10, EZ10k, EZ9 & EZ9k

Our Quick Disconnect wiring system makes for easy replacement of the LCD Display. It's the RPI advantage!

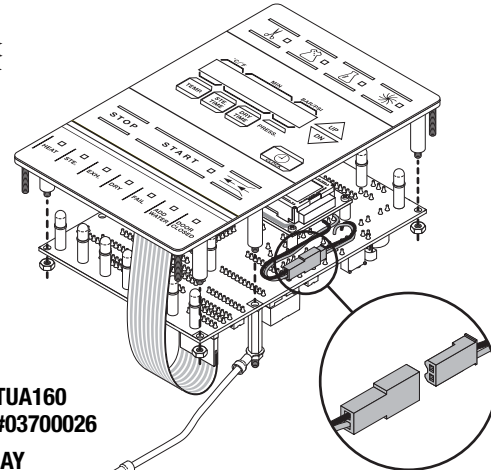

RPI Part #TUA160
OEM Part #03700026

LCD DISPLAY ASSEMBLY (GRAY)

- See **Important Note** below
- Includes all parts as shown

Fits: Front Panel

Models: 1730E/EK, 2340E/EA/EK/EKA, 2540E/EA/EK/EKA, 3850E/EA/EK/EKA, 3870E/EA/EK/EKA, EZ10, EZ10k, EZ9 & EZ9k

Our Quick Disconnect wiring system makes for easy replacement of the LCD Display. It's the RPI advantage!

RPI Part #TUK150
OEM Part #03700027-1

KEYPAD (BLUE)

- Size: 6.50" x 4.00"
- Material: Keypad with aluminum backing panel

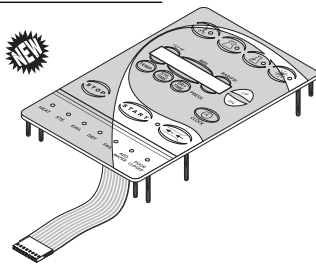

RPI Part #TUK151
OEM Part #3700027

KEYPAD (GRAY)

- Size: 6.50" x 4.00"
- Material: Keypad with aluminum backing panel

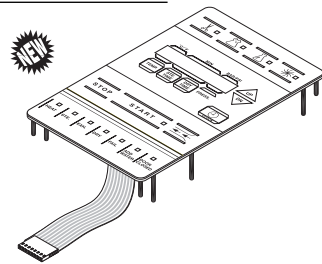

RPI Part #TUD152
OEM Part #CTP201-0168

LCD DISPLAY (BLUE)

- +5VDC, 16 character, single line
- Includes all parts as shown

Fits: Display Board (PREDG) With Blue LCD

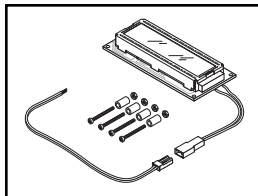

RPI Part #TUD153
OEM Part #4400317

LCD DISPLAY (GREEN)

- +5VDC, 16 character, single line
- Includes all parts as shown

Fits: Display Board (PREDG) With Green LCD

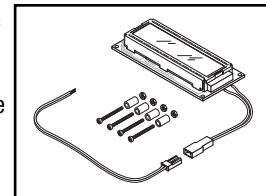

RPI Part #TUB161
OEM Part #CTP000-0133

DISPLAY BOARD (PREDG) WITH BLUE LCD

- See **Important Note** below
- Includes: LCD Display (Blue) (RPI Part #TUD152)

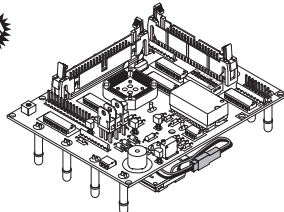

RPI Part #TUB162
OEM Part #03700024

DISPLAY BOARD (PREDG) WITH GREEN LCD

- See **Important Note** below
- Includes: LCD Display (Green) (RPI Part #TUD153)

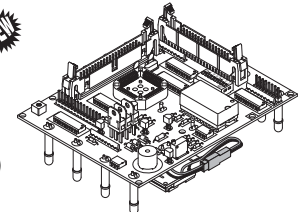

Important Note: These boards do not contain the main processor chip! It is recommended that you use a Chip Extractor (RPI Part #RPT962) and Grounding Strap (RPI Part #RPS998) to remove the processor chip from your old board to install on the new board.



replacement parts industries, inc.

CALL (800) 221-9723 • FAX (818) 882-7028 • EMAIL order@ripiparts.com • WEBSITE www.ripiparts.com

The above parts are manufactured by Replacement Parts Industries, Inc. to fit Tuttnauer equipment. All product names used in this document are trademarks or registered trademarks of their respective holders. Tuttnauer Rd1 - 1605TU Show 06/17

SECTION
10

PAGE
1714

UPDATED
06/17

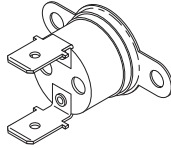

RPI Part #TUT155
OEM Part #THE005-0012

OVERTEMP THERMOSTAT

- Automatic reset
- Opens at 150°C (302°F), Closes at 115°C (115°F)
- 15A @120VAC; 10A @ 220VAC; 1/4" Tabs
- Fits:** Between Heating Element and Chamber
- Models:** Valueklave (1730MKV) & 1730M/MK

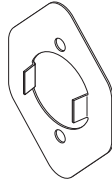

RPI Part #TUP062
OEM Part #CT910020

THERMOSTAT STOP PLATE

- Material: Stainless steel
- Designed to allow the control thermostat knob to start and stop within the scale printed on the front panel.
- Also available: Control Thermostat (RPI Part #TUT007)
- Fits:** Control Thermostat
- Models:** 1730M/MK, 2340M/MK, 2540M/MK, 3850M/MK & 3870M/MK

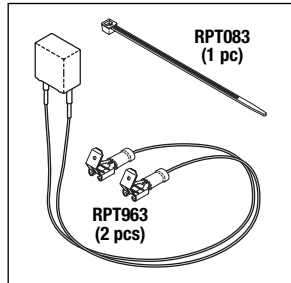

RPI Part #TUC138
OEM Part #ELC258-0004

CAPACITOR (.47µF)

- Size: .709" lg. x .433" w x .748" tall
- .47µF; 250VAC
- 13" lg. wires: (1) black and (1) red
- Includes all parts as shown
- Fits:** Water Pump
- Models:** 1730E/EK, 2340E/EA/EK/EKA, 2540E/EA/EK/EKA, 3850E/EA/EK/EKA, 3870E/EA/EK/EKA, EZ10, EZ10k, EZ9 & EZ9k

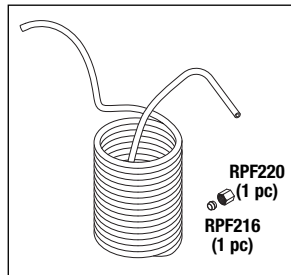

RPI Part #TUC145
OEM Part #CMT387-0029
& CC836101

CONDENSATION COIL

- Material: 1/4" copper tubing
- Includes all parts as shown
- Fits:** Water Reservoir
- Models:** 3850E/EA/M/MK & 3870E/EA/M/MK

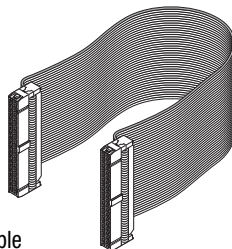

RPI Part #TUC144
OEM Part #02830105

RIBBON CABLE

- 40 pin (2 x 20) IDC connector with a 12" lg. cable
- Connects the Display Board (PREDG) with Blue LCD (RPI part #TUB161) or Display Board (PREDG) with Green LCD (RPI Part #TUB162) to the PCB AJUNC-3
- Models:** 1730E/EK, 2340E/EA/EK/EKA, 2540E/EA/EK/EKA, 3850E/EA/EK/EKA, 3870E/EA/EK/EKA, EZ10, EZ10k, EZ9 & EZ9k

NEW SIGNAL LIGHTS!

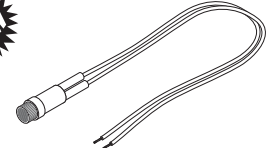

RPI Part #TUL136
OEM Part #01910261

SIGNAL LIGHT (AMBER 220V)

- 250VAC; Neon
- 8" lg. #22 AWG wire; 5/16" dia. mounting hole
- Also available: Signal Light (Amber 125V) (RPI Part #MDL021)
- Fits:** Front Panel
- Models:** 1730EK/MK, 2340E/EA/EK/EKA/M/MK, 2540E/EA/EK/EKA/M/MK, 3850E/EA/M & 3870E/EA/M

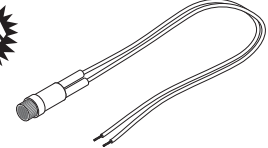

RPI Part #TUL137
OEM Part #01919262

SIGNAL LIGHT (GREEN 220V)

- 250VAC; Neon
- 8" lg. #22 AWG wires; 5/16" dia. mounting hole
- Also available: Signal Light (Green 125V) (RPI Part #MDL022)
- Fits:** Front Panel
- Models:** 1730EK/MK, 2340E/EA/EK/EKA/M/MK, 2540E/EA/EK/EKA/M/MK, 3850E/EA/M & 3870E/EA/M

New Tools to Make Your Job Easier!

Perfect for reducing static discharge when working on fragile electrical components!

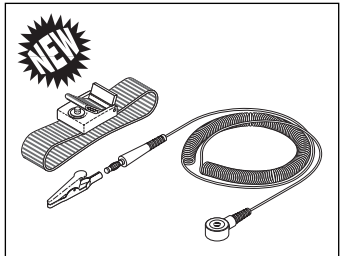

RPI Part #RPS998
OEM Part # (No OEM Part # Available)

GROUNDING STRAP

- Specifically designed for grounding to an ESD work bench or a chassis to help reduce static discharge

Perfect for removing and installing the main processor chip for the display board!

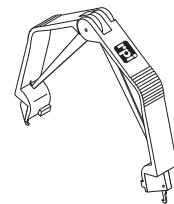

RPI Part #RPT962
OEM Part # (No OEM Part # Available)

CHIP EXTRACTOR

- Specially designed tool for easy removal of PLCC type devices from their sockets

Perfect for removing terminals from connectors!

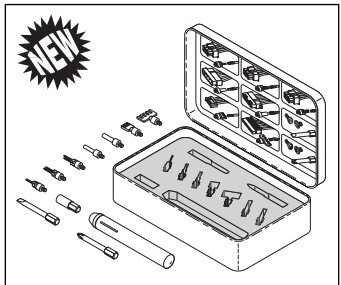

RPI Part #RPK961
OEM Part # (No OEM Part # Available)

TERMINAL TOOL KIT

- Tools made specifically for easy removal of terminals from 4 and 8 pin EPS (12V), ATX, Molex, TE/Amp, JST and PCI-E connectors

NEW HEATING ELEMENTS & HARDWARE!

RPI Part #TUH147
OEM Part #HEA009-0008
HEATING ELEMENT
 • 500W, 230V, ~105Ω
Fits: 16" Chamber
Models: 3870E/EA/EKA/M/MK



RPI Part #TUH148
OEM Part #HEA009-0007
HEATING ELEMENT
 • 600W, 230V, ~88Ω
Fits: 16" Chamber
Models: 3850E/EA/EK/EKA/M/MK



Also Sold Separately ...

HEATER HARDWARE
RPI Part #TUH052

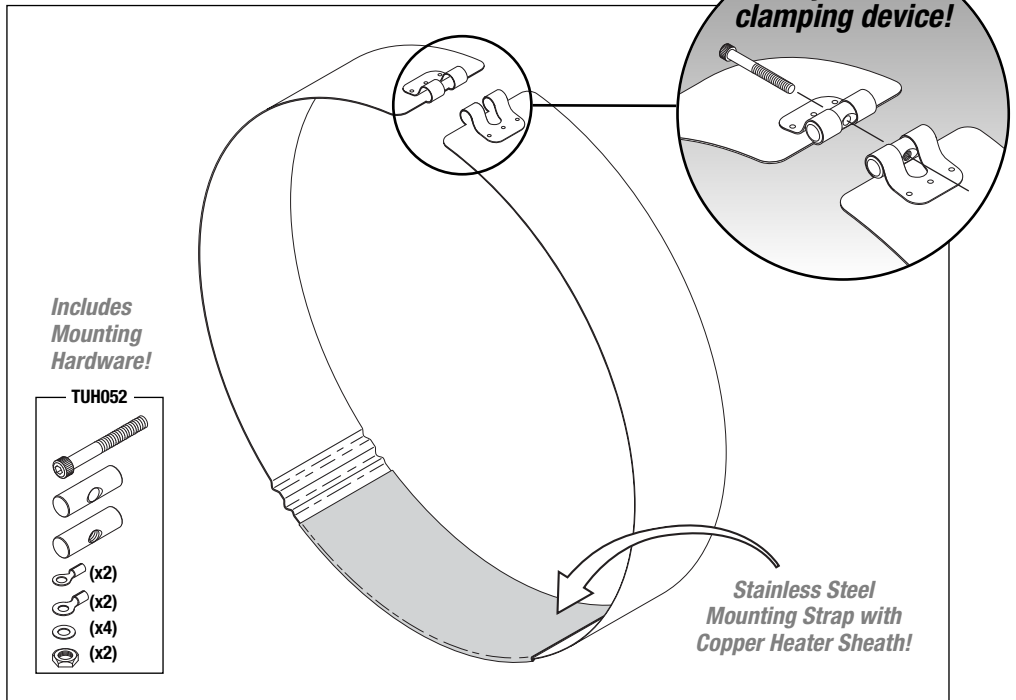

All RPI Heater Elements have stainless steel mounting straps and include stainless steel Heater Hardware (RPI Part #TUH052).*
Plus, RPI is planning on upgrading all of these Heater Elements to include copper heater sheaths!

RPI Part #	OEM Part #	Description	Specifications	Chamber Diameter	Fits Model(s)
TUH027	01720001	Heater Element - Now with Copper Sheath!	350W, 120V, ~41Ω	7"	1730E/M
TUH004	01720011	Heater Element - Now with Copper Sheath!	450W, 120V, ~32Ω	7"	ValueKlave (1730MKV) & 1730E/EK/M/MK
TUH016*	01720012	Heater Element	450W, 230V, ~117Ω	7"	1730EK/MK
TUH005*	01720002	Heater Element	350W, 120V, ~41Ω	9"	EZ9 & 2340E/M
TUH017	01720013	Heater Element - Now with Copper Sheath!	550W, 230V, ~96Ω	9"	2340EK/MK
TUH006	01720003	Heater Element - Now with Copper Sheath!	350W, 120V, ~41Ω	10"	EZ10 & 2540E/M
TUH018	01720014	Heater Element - Now with Copper Sheath!	550W, 230V, ~96Ω	10"	EZ10k & 2540EK/MK
TUH147	HEA009-0008	Heating Element - With Copper Sheath!	500W, 230V, ~105Ω	16"	3870E/EA/EKA/M/MK
TUH148	HEA009-0007	Heating Element - With Copper Sheath	600W, 230V, ~88Ω	16"	3850E/EA/EK/EKA/M/MK

* Heater Elements (RPI Part # TUH005 & TUH016) include Attaching Hardware (RPI Part #TUH015) - Also sold separately.
 All other Heating Elements include Heater Hardware (RPI Part #TUH052) - Also sold separately.



RPI Part #TUS146
OEM Part #SHIM

DOOR SHIM

- Used behind the door gasket
 - Material: Stainless steel
 - Also available: Door Gasket (RPI Part #TUG074)
- Fits:** Door Groove
Models: 3850E/EA/EHS/M/MK & 3870E/EA/EHS/M/MK



RPI Part #TUH158
OEM Part #CT241010

DOOR BELLOWS HOUSING

- Material: Brass
 - Size: .57" O.D. x 2.12" lg.
 - Also available: Door Bellows Kit (RPI Part #TUK030), Door Bellows (RPI Part #TUB019) and Door Bellows Housing Bolt (RPI Part #TUB064)
- Fits:** Door
Models: Valueklave (1730MKV), 1730E/EK/M/MK, 2340E/EA/EK/EKA/M/MK, 2540E/EA/EK/EKA/M/MK/MKA, 3850E/EA/M/MK, 3870E/EA/M

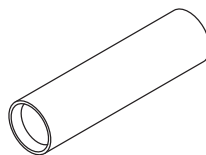

RPI Part #TUA066
OEM Part #CC312036 & CT312036

DOOR SWITCH ACTUATOR

- This kit now fits all Tuttnauer models
 - Use to adjust door switch activation
 - Includes all parts as shown
 - Also available: Door Switch (RPI Part #TUS014) and Rubber Boot for Door Switch (RPI Part #TUB072)
- Fits:** Door
Models: Valueklave (1730MKV), 1730E/EK/M/MK, 2340E/EA/EK/EKA/M/MK, 2540E/EA/EK/EKA/M/MK, 3850E/EA/EK/EKA/M/MK, 3870E/EA/EK/EKA/M/MK, EZ10, EZ10k & EZ9

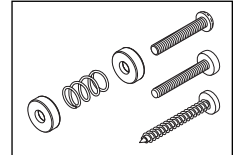

LCD DISPLAYS, BOARDS, AND MORE TO FIT Tuttnauer Table Top Sterilizers!

Now Available:

- Capacitor (.47µF)
- Condensation Coil
- Display Board (PREDG)
- Heating Elements
- Keypads
- LCD Display Assemblies
- LCD Displays
- Overtemp Thermostat
- Ribbon Cable
- Signal Lights
- Tools and more!

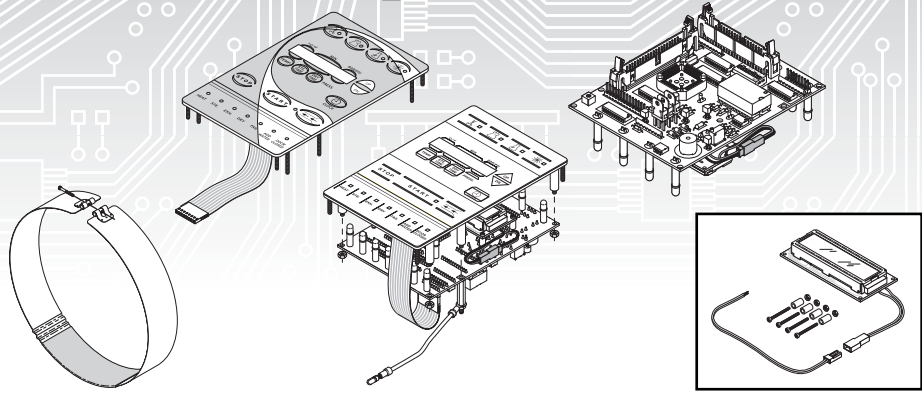

New Parts to fit Tuttnauer Manual and Automatic Sterilizers!

ADDRESS SERVICES REQUESTED

PERMIT NO. 2399
VAN NUYS, CA
U.S. POSTAGE PAID
PRESORTED STANDARD

replacement parts industries, inc. 
20338 Corisco Street • Chatsworth, California • 91311

Keep Your Tuttnauer Sterilizers Clean With RPI!

RPI Part #TUC094
OEM Part #CB0010

TUTT-CLEAN™

- Sterilizer cleaner
- (1) Box of 10 packets

Models: Valueklave
(1730 MKV), 1730E/EK/M/MK,
2340E/EA/EK/EKA/M/MK,
2540E/EA/EHS/EK/EKA/M/MK,
3850E/EA/EHS/M/MK, 3870E/EA/EHS/M,
EZ9, EZ10 & EZ10k



- Also available by the case of 12 boxes!
Just ask for TUTT-CLEAN™ (CASE)
(RPI Part #TUC095)

RPI Part #RPK791
OEM Part # (No OEM Part # Available)

CLEANING KIT

- Supplied in a convenient sturdy canvas Carrying Case (RPI Part #RPC799)
- Includes all parts as shown
- All parts also sold separately!

