

**New Parts to fit**

**STERRAD NX, 100NX & 100S**  
**Hydrogen Peroxide Sterilization Systems!**



**RPI Part #SDA048**  
**OEM Part #**

(No OEM Part # Available)

**VALVE MANIFOLD ASSEMBLY**

- Includes: Transition Valve (RPI Part #SDV046), Inlet Valve (RPI Part #SDV047), Valve Manifold (RPI Part #SDM081), installed rupture disk, (1 pc) O-ring (RPI Part #RX0054), (2) O-rings, (1 pc) High Temp Lubricant (RPI Part #RPL090), and mounting hardware
  - Also available: Pliers (Soft Jaw) (RPI Part #RXT005) used to grip Ultra-Torr® Fittings
- Fits:** Vaporizer/Condenser Assembly  
**Model:** NX

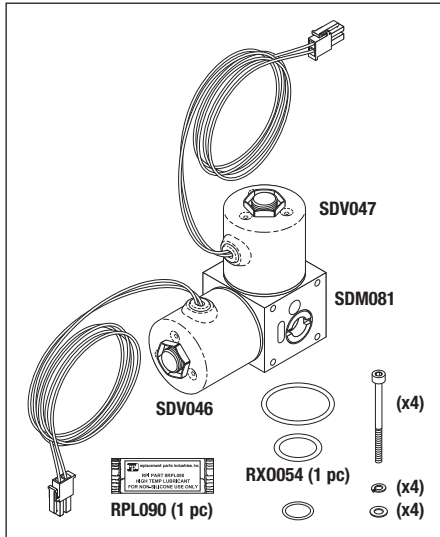

**RPI Part #SDA082**  
**OEM Part #**

(No OEM Part # Available)

**VALVE MANIFOLD ASSEMBLY**

- Includes: (2) Inlet Valve (RPI Part #SDV047), Valve Manifold (RPI Part #SDM081), installed rupture disk, (1 pc) O-ring (RPI Part #RX0054), (2) O-rings, (1 pc) High Temp Lubricant (RPI Part #RPL090), and mounting hardware
  - Also available: Pliers (Soft Jaw) (RPI Part #RXT005) used to grip Ultra-Torr® Fittings
- Fits:** Vaporizer/Condenser Assembly  
**Model:** 100NX

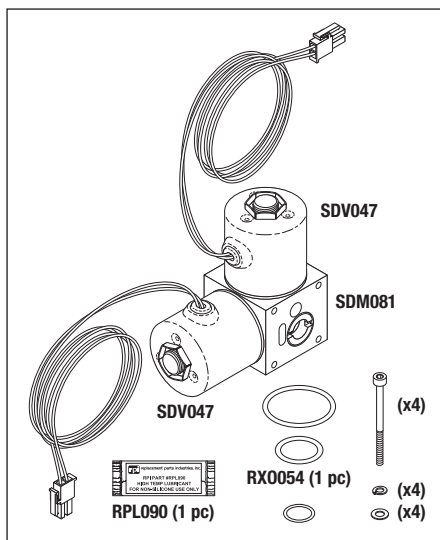

**RPI Part #SDM081**  
**OEM Part #**

(No OEM Part # Available)

**VALVE MANIFOLD**

- Includes installed rupture disk and all parts as shown
  - Included in: Valve Manifold Assembly (RPI Part #SDA048) and Valve Manifold Assembly (RPI Part #SDA082)
  - Also available: Pliers (Soft Jaw) (RPI Part #RXT005) used to grip Ultra-Torr® Fittings, Transition Valve (RPI Part #SDV046), and Inlet Valve (RPI Part #SDV047)
- Fits:** Vaporizer/Condenser Assembly  
**Models:** NX & 100NX

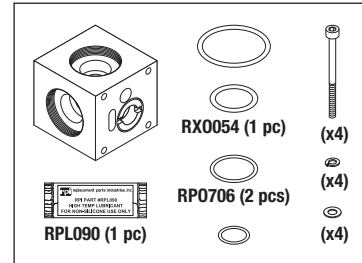

**RPI Part #SDV046**  
**OEM Part #40-54257-001**

**TRANSITION VALVE**

- Manifold mount
  - 24VDC, 14W (40-42 Ω); 22" lg. wire with Molex connector
  - Material: Viton®/FKM seals
  - Included in: Valve Manifold Assembly (RPI Part #SDA048)
  - Also available: Spanner Nut (RPI Part #ILS014) and Double Ended Spanner Wrench (RPI Part #RPT501)
- Fits:** Vaporizer/Condenser Assembly  
**Models:** NX

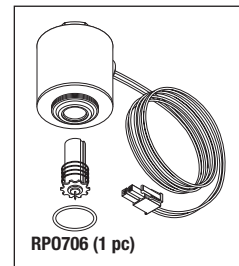

**RPI Part #SDV047**  
**OEM Part #28-51428-002**

**INLET VALVE**

- Manifold mount
  - 24VDC, 10W (59-61 Ω); 22" lg. wire with Molex connector
  - Material: Viton®/FKM seals
  - Included in: PM-1 Kit (RPI Part #SDK058), PM-2 Kit (RPI Part #SDK059), Valve Manifold Assembly (RPI Part #SDA048), and Valve Manifold Assembly (RPI Part #SDA082)
  - Also available: Spanner Nut (RPI Part #ILS014) and Double Ended Spanner Wrench (RPI Part #RPT501)
- Fits:** Vaporizer/Condenser Assembly  
**Models:** NX & 100NX

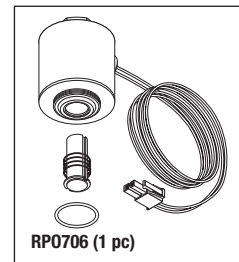

**replacement parts industries, inc.**

CALL (800) 221-9723 • FAX (818) 882-7028 • EMAIL [order@ripiparts.com](mailto:order@ripiparts.com) • WEBSITE [www.rpiparts.com](http://www.rpiparts.com)

The above parts are manufactured by Replacement Parts Industries, Inc. to fit the equipment noted. All product names used in this document are trademarks or registered trademarks of their respective holders. Flyer Code 1809SD Rd3 SHOW 12/19 Updated 01/29/2020

**RPI Part #RX0054**

**OEM Part #** (No OEM Part # Available)  
**Industry Part #AS568-116**

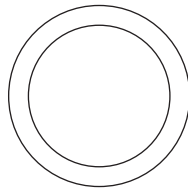

SHOWN  
ACTUAL SIZE

**O-RING**

- 3 per package
- Size: .737" ID x .943" OD x .103" C/S
- Material: Viton®/FKM
- Included in: Valve Manifold (RPI Part #SDM081), Valve Manifold Assembly (RPI Part #SDA048), and Valve Manifold Assembly (RPI Part #SDA082)

**Fits:** Ultra-Torr® Fittings

**Models:** NX, 100NX

**RPI Part #RXT005**

**OEM Part #** (No OEM Part # Available)

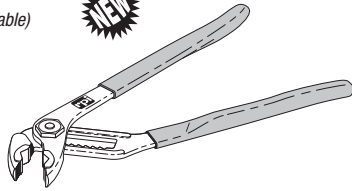

**PLIERS (SOFT JAW)**

- These adjustable pliers are ideal for gripping and protecting delicate surfaces without scarring.
- 1.75" max opening; 10" lg.
- Also available: Replacement Pads (RPI Part #RXT006)

**Models:** NX, 100NX & 100S

**RPI Part #RXT006**

**OEM Part #** (No OEM Part # Available)

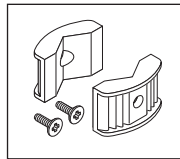

**REPLACEMENT PADS**

- Material: Nylon pads
- Includes: 2 replacement pads and mounting hardware
- Also available: Pliers (Soft Jaw) (RPI Part #RXT005)

**Models:** NX, 100NX & 100S

**RPI Part #RXT020**

**OEM Part #** (No OEM Part # Available)

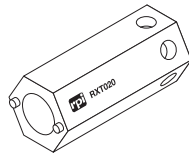

**SPANNER WRENCH**

- Size: 1.25" Hex x 3.00" lg.
- Material: Blue anodized aluminum
- Note: Holes through hex body allow use of a screwdriver as a leverage handle.

**Fits:** Vent Valve

**Models:** NX, 100NX & 100S

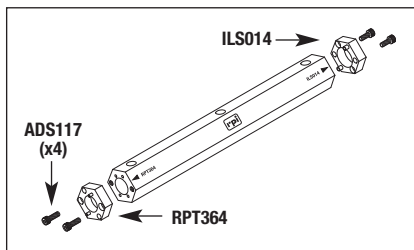

**RPI Part #RPT501**

**OEM Part #**

(No OEM Part # Available)

**DOUBLE ENDED SPANNER WRENCH**

- Size: .875" HEX x ~7" lg.
- Material: Aluminum handle with stainless steel end attachments
- Includes all parts as shown
- Reversible and replaceable end attachments allow easy replacement of damaged pins
- Holes thru handle allow use of screwdriver as a leverage handle

**Models:** NX, 100NX & 100S

**RPI Part #SDA071**

**OEM Part #108892-01**

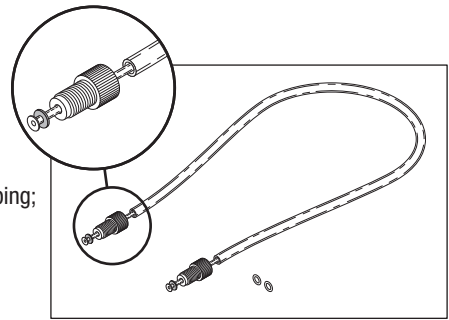

**TUBING ASSEMBLY (H2O2 DELIVERY- 19" LG)**

- Material: PTFE and silicone tubing; 316 stainless steel fittings
- Includes: (2) O-rings

**Fits:** H2O2 Delivery Assembly

**Model:** NX

**RPI Part #SDA079**

**OEM Part #27-53249-003**

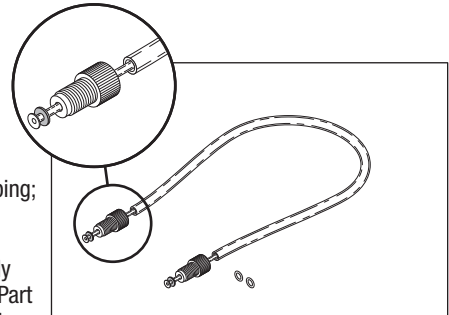

**TUBING ASSEMBLY (H2O2 DELIVERY- 16.50" LG)**

- Material: PTFE and silicone tubing; 316 stainless steel fittings
- Includes: (2) O-rings

• Also available: Tubing Assembly (H2O2 Delivery - 22" LG) (RPI Part #SDA080) and Tubing Assembly (H2O2 Delivery - 38.50" LG) (RPI Part #SDA068)

**Fits:** DUO Module

**Model:** 100NX

**RPI Part #SDA080**

**OEM Part #27-53249-004**

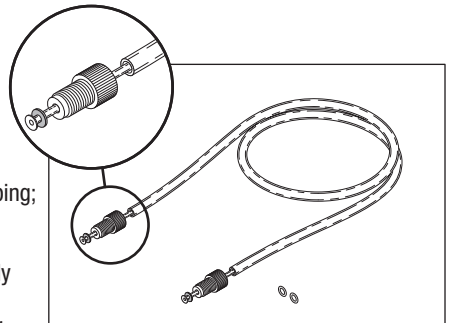

**TUBING ASSEMBLY (H2O2 DELIVERY- 22" LG)**

- Material: PTFE and silicone tubing; 316 stainless steel fittings
- Includes: (2) O-rings

• Also available: Tubing Assembly (H2O2 Delivery - 16.50" LG) (RPI Part #SDA079) and Tubing Assembly (H2O2 Delivery - 38.50" LG) (RPI Part #SDA068)

**Fits:** DUO Module

**Model:** 100NX

**RPI Part #SDA068**

**OEM Part #27-53249-001**

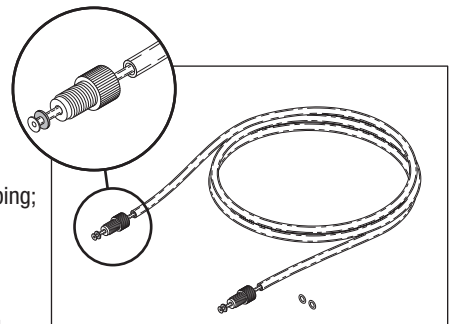

**TUBING ASSEMBLY (H2O2 DELIVERY - 38.50" LG)**

- Material: PTFE and silicone tubing; 316 stainless steel fittings
- Includes: (2) O-rings
- Included in: PM-2 Kit (RPI Part #SDK059)

• Also available: Tubing Assembly (H2O2 Delivery - 16.50" LG) (RPI Part #SDA079) and Tubing Assembly (H2O2 Delivery - 22" LG) (RPI Part #SDA080)

**Fits:** H2O2 Delivery Assembly or DUO Module

**Models:** 100NX

**RPI Part #SDA041**  
**OEM Part #03-52002-0-001**



**DOOR LOCK ASSEMBLY**

- Includes: Rotary solenoid, mounting bracket, Door Lock Sensor (RPI Part #SDS042), and mounting screws
- Coil: 24 VAC, 30.48Ω @ 20°C

**Fits:** Top of Chassis

**Model:** NX

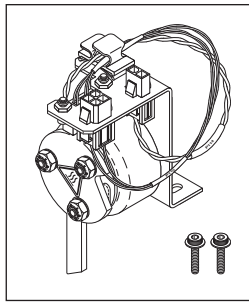

**RPI Part #SDT045**

**OEM Part #** (No OEM Part # Available)



**THERMOSTAT**

- Automatic reset
- Opens @ 194°F (90°C)
- Closes @ 158°F (70°C)
- 15A @ 120VAC; 10A @ 250VAC
- 1/4" tabs

**Fits:** Vaporizer/Condenser Assembly

**Models:** NX & 100NX

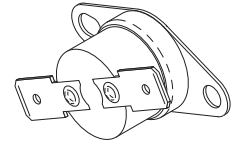

**RPI Part #SDS042**

**OEM Part #** (No OEM Part # Available)



**DOOR LOCK SENSOR**

- Includes: Mounting hardware
- Cable length: 8.75"
- Included in: Door Lock Assembly (RPI Part #SDA041)

**Fits:** Door Locking Solenoid Assembly

**Model:** NX

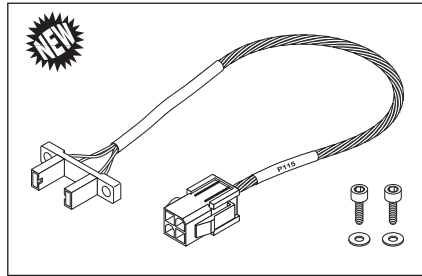

**RPI Part #SDN073**

**OEM Part #** (No OEM Part # Available)



**NEEDLE H2O2 TRANSFER**

- 2 per package
- Includes: (4) O-rings

**Fits:** Injector Valve Assembly

**Model:** 100S

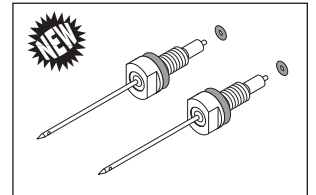

**RPI Part #SDK053**

**OEM Part #74-51398-001, 74-51398**



**DOOR LATCH KIT**

- Push to close latch (Catch and Keeper)
- Includes built-in single pole double throw switch and mounting hardware

**Fits:** NX Door Frame

**Model:** NX

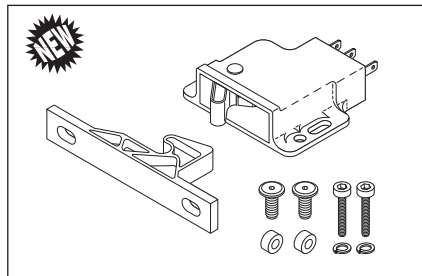

**RPI Part #SDN062**

**OEM Part #06-52675-0-001**  
(Needle), 22-00537-001 (O-ring)

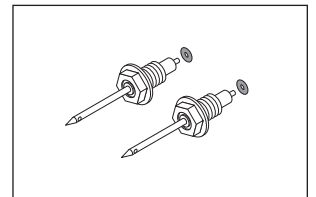

**NEEDLE H2O2 TRANSFER**

- 2 per package
- Includes: (2) O-rings
- Included in: PM-2 Kit (RPI Part #SDK059)

**Fits:** H2O2 Delivery Assembly

**Models:** NX & 100NX

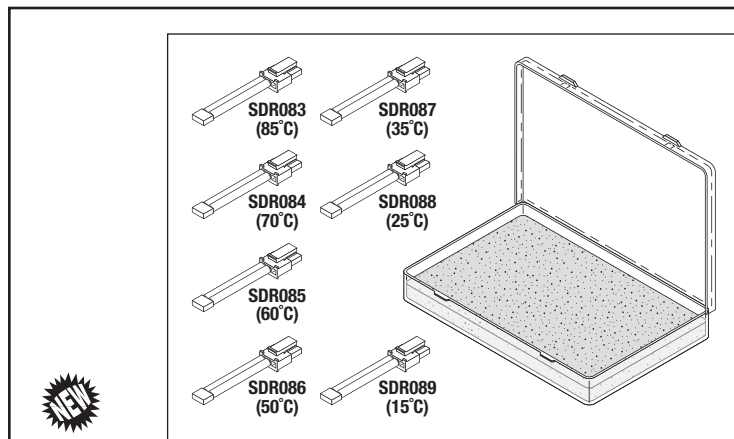

**RPI Part #SDK069**  
**OEM Part #04-52695-0-001**

**CALIBRATION RESISTOR KIT**

- Includes all 1% precision resistor values necessary to complete the Temperature Calibration procedure.
- Includes: Calibration Resistor (85°C) (RPI Part #SDR083), Calibration Resistor (70°C) (RPI Part #SDR084), Calibration Resistor (60°C) (RPI Part #SDR085), Calibration Resistor (50°C) (RPI Part #SDR086), Calibration Resistor (35°C) (RPI Part #SDR087), Calibration Resistor (25°C) (RPI Part #SDR088), and Calibration Resistor (15°C) (RPI Part #SDR089)

**Fits:** Electronics Module

**Model:** NX

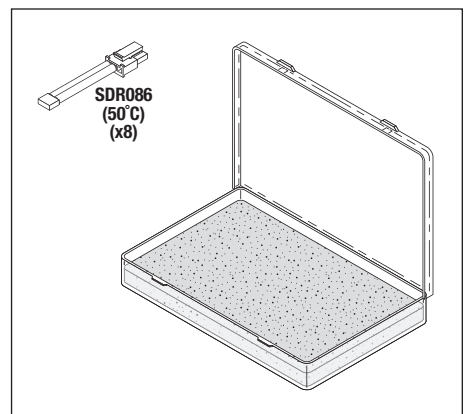

**RPI Part #SDK070**  
**OEM Part #04-54742-0-001**

**CALIBRATION RESISTOR KIT**

- Includes all 1% precision resistors necessary to complete the Temperature Calibration procedure.
- Includes: (8) Calibration Resistor (50°C) (RPI Part #SDR086)

**Fits:** Electronics Module

**Model:** 100NX

# New Parts to fit STERRAD NX, 100NX & 100S Hydrogen Peroxide Sterilization Systems!

RPI is pleased to offer the Valve Manifold Assemblies to fit the NX and 100NX. Plus, the Valve Manifold, Inlet Valve and Transition Valve are also sold separately. Simply replace the whole Valve Manifold or rebuild it, the choice is yours!

RPI is also excited to offer the Calibration Resistor Kits for the NX and 100NX. These Kits include all of the 1% precision resistor values necessary to complete the temperature calibration procedure!

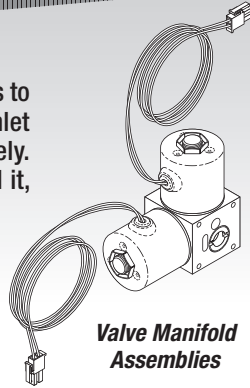

Valve Manifold  
Assemblies

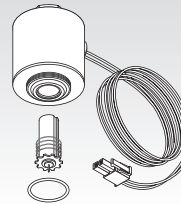

Transition  
Valve

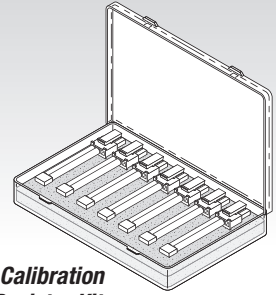

Calibration  
Resistor Kits

*See inside for even more new parts RPI offers to fit Sterrad NX, 100NX and 100S hydrogen peroxide sterilization systems!*

## New Parts to fit Sterrad NX, 100NX, & 100S Hydrogen Peroxide Sterilization Systems!

ADDRESS SERVICES REQUESTED

PRESENTED STANDARD  
U.S. POSTAGE PAID  
VAN NUYS, CA  
PERMIT NO. 2399

**replacement parts industries, inc.**  
625 Cochran Street • Simi Valley, California • 93065



## Don't Forget ... RPI also offers Annual and Bi-Annual PM Kits to fit Sterrad NX, 100NX, and 100S hydrogen peroxide sterilization systems!

RPI PM Kits include the parts that need to be replaced on an annual or bi-annual basis including:

- Catalytic Converter
- Vacuum Pump Oil
- Air Filters
- Oil Mist Filters
- Chamber Plastics Kit
- Vaporizer Plate
- Guide Rails
- Shelf Supports
- Electrode Spacers and more!

See our website, [www.rpiparts.com](http://www.rpiparts.com) for a complete list of PM Kits and more to fit Sterrad NX, 100NX and 100S!