



PRESTIGE-KAVO 210006 OLD VERSION I, 210006 NEW VERSION II & 210006 CLASSIC VERSION III



## INTRODUCING A NEW LINE OF PARTS FOR THE PRESTIGE • KAVO LINE OF STERILIZERS

### A MESSAGE FROM THE PRESIDENT

We are pleased to announce that as of January, 2010, we are the distributor of OEM parts for the Prestige line of autoclaves in the United States and Canada.

Please take a moment to look at the wide selection of parts we now carry for the classic model 210006 (also marketed under the KavoClave name), as well as the newer versions of the 210006 model, including those currently in production by Prestige Medical of England and distributed in the United States by Alfa Medical of Westbury, New York.

Best of all, the Prestige line of parts sold by RPI will be covered by RPI's guarantee that every part must meet the customer's 100% complete satisfaction. We will also offer the same excellent technical assistance for this line of autoclaves as we do for all other equipment we support. And, like all RPI parts, these parts will be in stock, ready to ship the same day the order is placed, Monday through Friday, 8:00 am - 4:30 pm (Pacific Time).

We look forward to supporting you with yet another great line of parts.

Sincerely,  
*Al Lapidus*

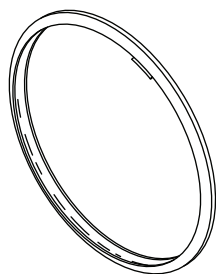

**RPI PART #KVG001  
OEM PART #219500**  
**DOOR GASKET**  
• 9.66" OD

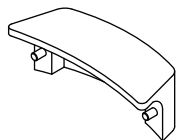

**RPI PART #KVC019  
OEM PART #219577**  
**GASKET OFFSET DEVICE COVER**  
• Plastic

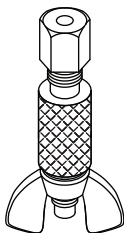

**RPI PART #KVP048  
OEM PART #219722**  
**THERMO PORT**  
• Feed-thru port for sterilizer calibration

**RPI PART #KVH034  
OEM PART #219696**

- HANDLE**
- Grey plastic
  - Includes mounting hardware

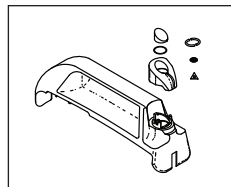
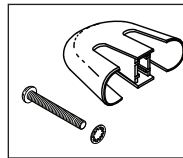

**RPI PART #KVH035  
OEM PART #219698**

- HANDLE MOULDING**
- Package contains:  
Valve Cap (RPI Part #KVC044)
  - Includes all parts as shown

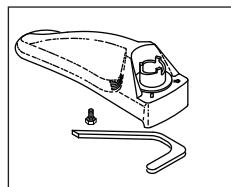

**RPI PART #KVC018  
OEM PART #219570**

- TOP COVER MOULDING**
- Plastic
  - Includes gasket and self sealing hex mounting bolt

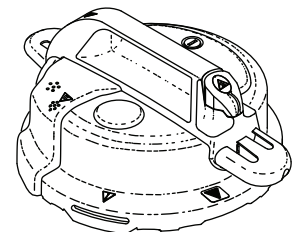

**RPI PART #KVL046  
OEM PART #219738**

- LID ASSEMBLY**
- Stainless steel
  - Package contains:  
Gasket (RPI Part #KVG001),  
Air Bleed Kit (RPI Part #KVK002),  
Pressure Indicator Kit (RPI Part #KVK003),  
Decal (Warning) (RPI Part #KVD013),  
Decal (Hot Warning) (RPI Part #KVD014),  
Depressurization Valve Kit (RPI Part #KVK043),  
Handle (RPI Part #KVH034),  
Handle Moulding (RPI Part #KVH035), and  
Safety Valve (26 PSI) (RPI Part #KVV037)

**RPI PART #KVL045  
OEM PART #219726**

- LID ASSEMBLY**
- Aluminum
  - Package contains:  
Gasket (RPI Part #KVG001),  
Air Bleed Kit (RPI Part #KVK002),  
Pressure Indicator Kit (RPI Part #KVK003),  
Decal (Warning) (RPI Part #KVD013),  
Decal (Hot Warning) (RPI Part #KVD014),  
Depressurization Valve Kit (RPI Part #KVK043),  
Handle (RPI Part #KVH034), and  
Handle Moulding (RPI Part #KVH035)



# Table Top Sterilizers

PRESTIGE•KAVO 210006 OLD VERSION I, 210006 NEW VERSION II & 210006 CLASSIC VERSION III

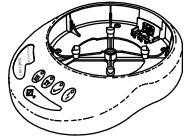

**RPI PART #KVK042**  
**OEM PART #219710**

**BASE KIT**

- Includes 134°C button decal
- All decals are installed
- Does not include Wire Kit
- Package contains:  
AC Inlet Receptacle (RPI Part #RPR710),  
Pillar Cap (RPI Part #KVC020), and  
Foot (RPI Part #KVF038)

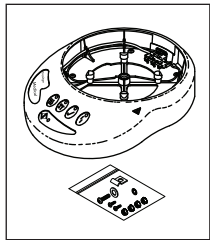

**RPI PART #KVK022**  
**OEM PART #219580**

**BASE KIT (220 VAC)**

- Includes: Single thermofuse wiring and mounting hardware kit, and 126°C button decal
- All decals are installed
- Package contains: Wire Kit (RPI Part #KVK026), AC Inlet Receptacle (RPI Part #KVR004), Pillar Cap (RPI Part #KVC020), and Foot (RPI Part #KVF038)

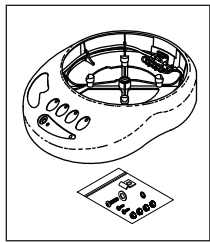

**RPI PART #KVK028**  
**OEM PART #219665**

**BASE KIT (110 VAC)**

- Double thermofuse wiring
- Includes: Wire Kit (RPI Part #KVK030), AC Inlet Receptacle (RPI Part #RPR710), Pillar Cap (RPI Part #KVC020), Bumper (Foot) black (RPI Part #RPB640), and mounting hardware kit

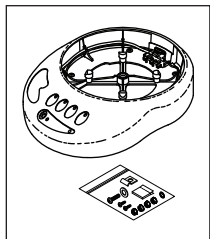

**RPI PART #KVK031**  
**OEM PART #219670**

**BASE KIT (220 VAC)**

- Includes: Wire Kit (RPI Part #KVK026), AC Inlet Receptacle (RPI Part #RPR710), Pillar Cap (RPI Part #KVC020), Foot (RPI Part #KVF038), and mounting hardware kit

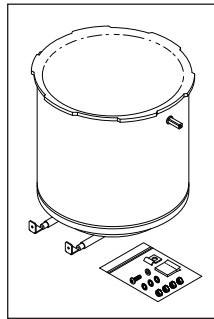

**RPI PART #KVK015**  
**OEM PART #219550**

**BODY KIT (230 VAC)**

- Chamber Only
- Includes mounting hardware
- Integral heater element

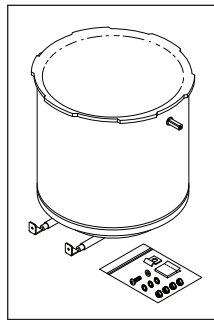

**RPI PART #KVK016**  
**OEM PART #219552**

**BODY KIT (110 VAC)**

- Chamber Only
- Includes mounting hardware
- Integral heater element

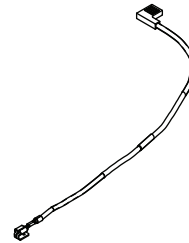

**RPI PART #KVF029**  
**OEM PART #219667**

**THERMAL FUSE**

- 152°C Thermofuse

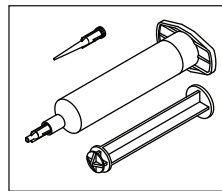

**RPI PART #RPC709**  
**OEM PART #219302**

**HEAT SINK COMPOUND**

- Includes: Syringe and Dispensing Tip



**RPI PART #KVC020**  
**OEM PART #219578**

**PILLAR CAP**

- 4 per package
- Vinyl

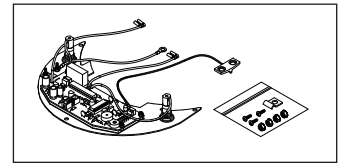

**RPI PART #KVK023**  
**OEM PART #219584**

**MODULE KIT (230 VAC)**

- Includes: Fuse holders with Fuse (RPI Part #RPF695), and mounting hardware

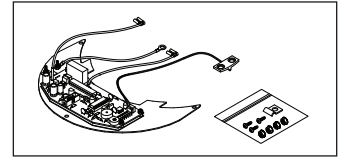

**RPI PART #KVK025**  
**OEM PART #219590**

**MODULE KIT (110 VAC)**

- Includes mounting hardware

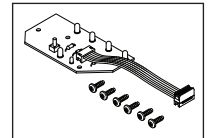

**RPI PART #KVA024**  
**OEM PART #219585**

**LED/SWITCH ASSEMBLY**

- Includes: PCB, Interface Cable, and mounting screws

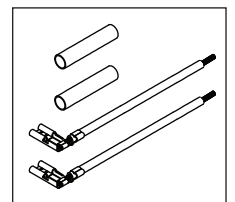

**RPI PART #KVK032**  
**OEM PART #219689**

**WIRE REPAIR KIT**

- Includes all parts as shown

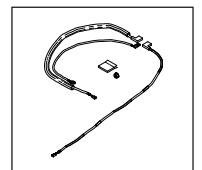

**RPI PART #KVK030**  
**OEM PART #219669**

**WIRE KIT (110 VAC)**

- (2) 152° C Thermofuse
- Includes White Tak and mounting nut

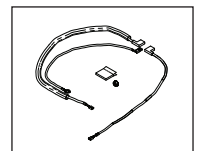

**RPI PART #KVK026**  
**OEM PART #219596**

**WIRE KIT (220 VAC)**

- (1) 152° C Thermofuse
- Includes: White Tak and mounting nut



# Table Top Sterilizers

PRESTIGE•KAVO 210006 OLD VERSION I, 210006 NEW VERSION II & 210006 CLASSIC VERSION III

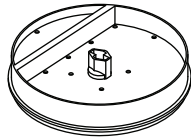

**RPI PART #KVT008  
OEM PART #219293  
INSTRUMENT TRAY**  
• Plastic



**RPI PART #KVB007  
OEM PART #219292  
INSTRUMENT BASKET (SMALL)**  
• Plastic  
• ~8.25" dia. x 6.50" height

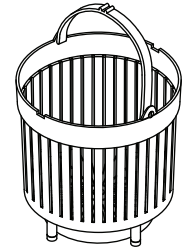

**RPI PART #KVB041  
OEM PART #219708  
INSTRUMENT BASKET (LARGE)**  
• Plastic  
• ~8.25" dia. x 7.63" height

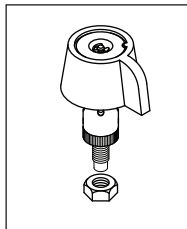

**RPI PART #KVK017  
OEM PART #219569  
DEPRESSURIZATION  
VALVE KIT**  
• Grey cap  
• Includes mounting nut

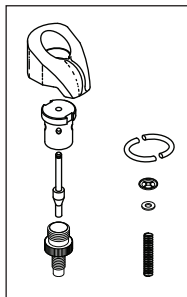

**RPI PART #KVK040  
OEM PART #219707  
DEPRESSURIZATION  
VALVE KIT**  
• White cap  
• Package contains:  
Valve Cap  
(RPI Part #KVC044)  
• Includes all parts as shown

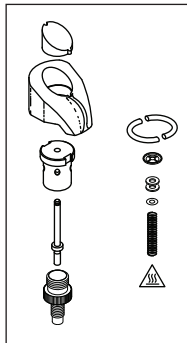

**RPI PART #KVK043  
OEM PART #219711  
DEPRESSURIZATION  
VALVE KIT**  
• White cap  
• Package contains:  
Valve Cap  
(RPI Part #KVC044)  
• Includes all parts as shown

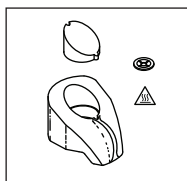

**RPI PART #KVC044  
OEM PART #219713  
VALVE CAP**  
• White cap  
• Package contains:  
Decal (Hot Warning)  
(RPI Part #KVD014)  
• Includes all parts as shown

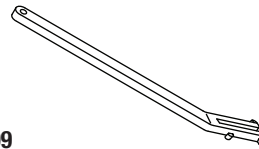

**RPI PART #KVF009  
OEM PART #219294  
LIFTER FORK**  
• Plastic

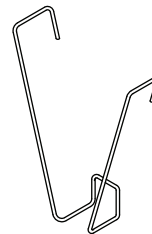

**RPI PART #KVS010  
OEM PART #219295  
V-SUPPORT**  
• .12" dia. stainless steel wire

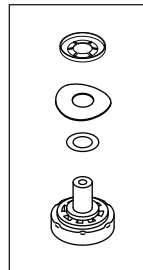

**RPI PART #KVK002  
OEM PART #219202  
AIR BLEED KIT**  
• Includes all parts as shown

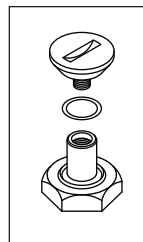

**RPI PART #KVK003  
OEM PART #219203  
PRESSURE INDICATOR KIT**  
• Includes all parts as shown

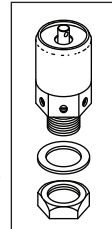

**RPI PART #KVV037  
OEM PART #219704  
SAFETY VALVE (26 PSI)**  
• Brass Body  
• Includes panel mounting hardware  
• Cracking pressure: 26 PSI

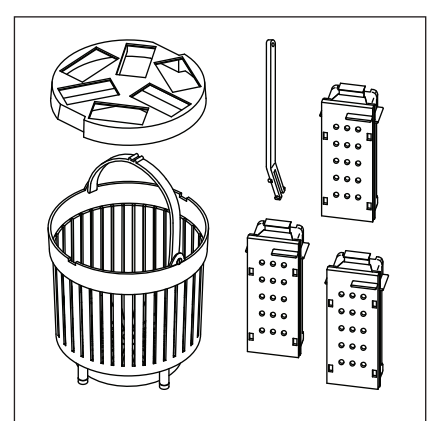

**RPI PART #KVK047  
OEM PART #219728  
CASSETTE RACK KIT**  
• Includes all parts as shown  
• Package contains: Instrument Basket  
(Large) (RPI Part #KVB041), Lifter Fork  
(RPI Part #KVF009), and (3) each  
Cassette (RPI Part #KVC006)

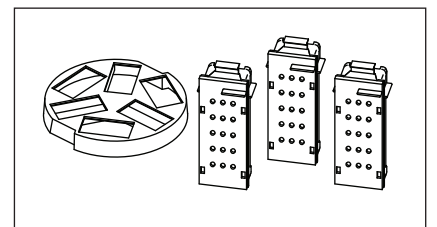

**RPI PART #KVK039  
OEM PART #219706  
CASSETTE HOLDER KIT**  
• Plastic cassette holder  
• (3) Cassettes (RPI Part #KVC006)



**RPI PART #KVC006  
OEM PART #219291  
CASSETTE**  
• Plastic

ADDRESS SERVICES REQUESTED

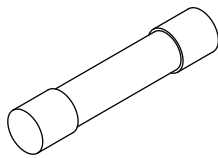

**RPI PART #RPF695**  
**OEM PART #219281**  
**FUSE (10A)**  
• Ceramic "Fast Acting"

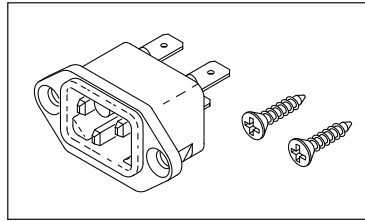

**RPI PART #RPR710**  
**OEM PART #219235**  
**AC INLET RECEPTACLE**  
• 15A @ 125VAC  
• Keyed mating feature

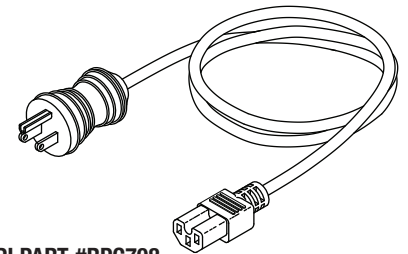

**RPI PART #RPC708**  
**OEM PART #219299**  
**POWER CORD**  
• Hospital Grade; 6' lg.  
• Keyed mating feature

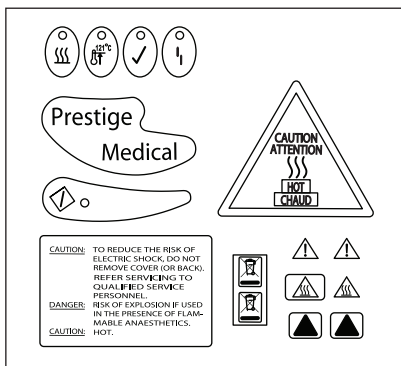

**RPI PART #KVD036**  
**OEM PART #219701**

**DECAL KIT**

- Includes all parts as shown (121°C button decal)
- Package contains:  
Decal (Warning) (RPI Part #KVD013) and  
Decal (Hot Warning) (RPI Part #KVD014)

**RPI PART #KVD013**  
**OEM PART #219535**  
**DECAL (WARNING)**

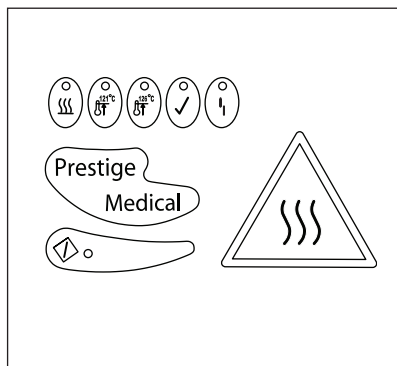

**RPI PART #KVD033**  
**OEM PART #219691/219600**

**DECAL KIT**

- Includes all parts as shown (both 121°C and 126°C button decals)

**RPI PART #KVD014**  
**OEM PART #219536**  
**DECAL (HOT WARNING)**

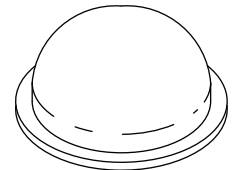

**RPI PART #KVF021**  
**OEM PART #219579**  
**FRONT FOOT SUPPORT**  
• Rubber foot

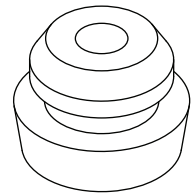

**RPI PART #KVF038**  
**OEM PART #219705**  
**FOOT**  
• 4 per package  
• White Silicone