

Models: AirStar® 1, 2-1, 2-2, 3, 5, 7, 10D, 10M, 10 NEO, 12D, 12M, 21D, 21M, 21 NEO, 22D, 22M, 22 NEO, 30D, 30M, 30 NEO, 40D, 40M, 40 NEO, 50D, 50M, 50 NEO, 70D, 70M, 70 NEO & 100M

Please Note: Model Numbers ending in "D" designate compressors with Dessicant Dryers, While Model Numbers ending in "M" designate compressors with Membrane Dryers.

New Parts to fit

# AIR TECHNIQUES AIRSTAR® Dental Compressors

DENTAL COMPRESSORS – Air Techniques



**RPI Part #CMK247**  
**OEM Part #86441**

**CHECK VALVE UPGRADE KIT**

- Includes all parts as shown

**Fits:** Main Tank Assembly  
**Models:** AirStar 10D

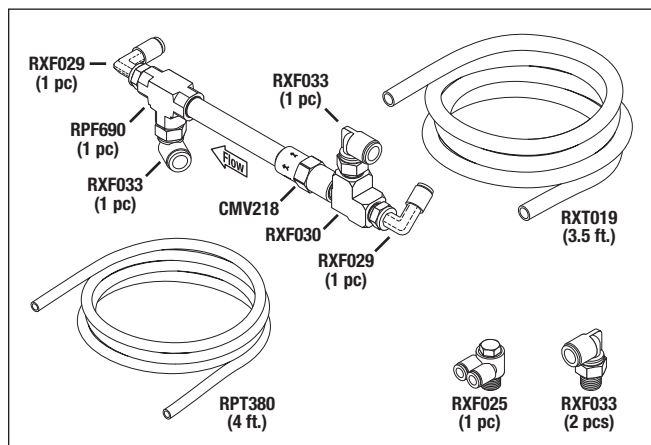

**RPI Part #CMV217**  
**OEM Part #87045, 004761SP**

**CHECK VALVE**

- Ports: 3/8" FPT Inlet x 3/8" MPT Outlet
- Material: Brass body; Buna-N seal
- Size: 7/8" Hex x 1.94" lg.

**Fits:** Manifold Assembly  
**Models:** AirStar 10M, AirStar 12M, AirStar 21M, AirStar 22M, AirStar 30M, AirStar 40M, AirStar 50M, AirStar 70M & AirStar 100M

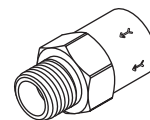

**RPI Part #CMK248**  
**OEM Part #86443**

**CHECK VALVE UPGRADE KIT**

- Includes all parts as shown

**Fits:** Main Tank Assembly  
**Models:** AirStar 21D, AirStar 22D, AirStar 30D & AirStar 50D

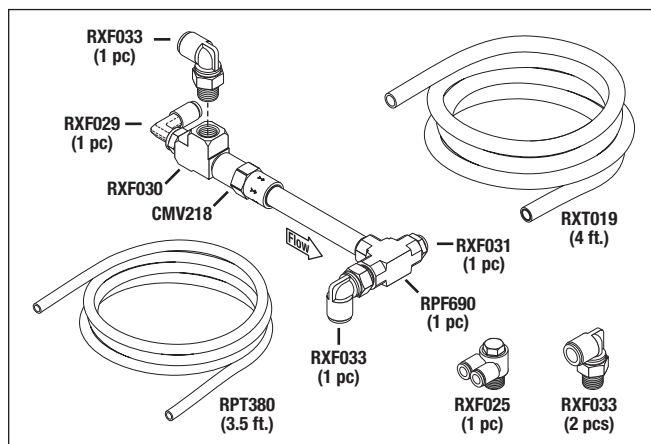

**RPI Part #CMV218**  
**OEM Part #85659**

**CHECK VALVE**

- Cracking pressure: 1-5 PSI
- Ports: 1/4" FPT inlet x 1/4" FPT outlet
- Material: Brass body, Buna-N seal
- Size: .69" x 1.80" lg.
- Included In: Check Valve Upgrade Kit (RPI Part #'s CMK247 & CMK248)

**Fits:** Manifold Assembly  
**Models:** AirStar 10D, AirStar 21D, AirStar 22D, AirStar 30D, AirStar 50D & AirStar 70D

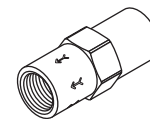

**RPI Part #CMK249**  
**OEM Part #86447**

**CHECK VALVE UPGRADE KIT**

- Includes all parts as shown

**Fits:** Main Tank Assembly  
**Models:** AirStar 70D

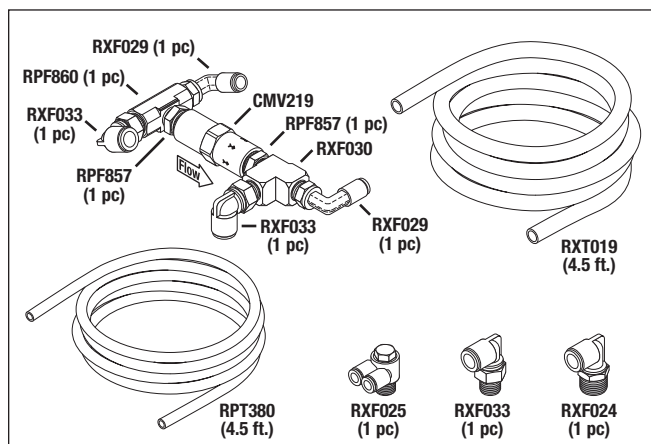

**RPI Part #CMV219**  
**OEM Part #86692**

**CHECK VALVE**

- Cracking pressure: 1.0 PSI
- Ports: 3/8" FPT inlet x 3/8" FPT outlet
- Material: Brass body, Buna-N seal
- Size: .88" x 2.25" lg.
- Included In: Check Valve Upgrade Kit (RPI Part #CMK249)

**Fits:** Manifold Assembly  
**Models:** AirStar 70D

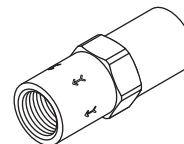

replacement parts industries, inc.

CALL (800) 221-9723 • FAX (818) 882-7028 • EMAIL [order@ripiparts.com](mailto:order@ripiparts.com) • WEBSITE [www.ripiparts.com](http://www.ripiparts.com)

The above parts are manufactured by Replacement Parts Industries, Inc. to fit the equipment noted. All product names used in this document are trademarks or registered trademarks of their respective holders. Show 01/19

Models: AirStar® 1, 2-1, 2-2, 3, 5, 7, 10D, 10M, 10 NEO, 12D, 12M, 21D, 21M, 21 NEO, 22D, 22M, 22 NEO, 30D, 30M, 30 NEO, 40D, 40M, 40 NEO, 50D, 50M, 50 NEO, 70D, 70M, 70 NEO & 100M

Please Note: Model Numbers ending in "D" designate compressors with Dessicant Dryers, While Model Numbers ending in "M" designate compressors with Membrane Dryers.

**RPI Part #CMV250**  
**OEM Part #85839**

**SOLENOID VALVE (REGENERATION SYSTEM)**

- Ports: 1/8" FPT; 2-way; N.C.
- 24/60VAC, 50Hz., 8.5W; 1/4" tabs
- Includes all parts as shown
- Also available: Solenoid Valve Repair Kit, (RPI Part #VPK006)

**Fits:** Regeneration System  
**Models:** AirStar 50D and AirStar 70D

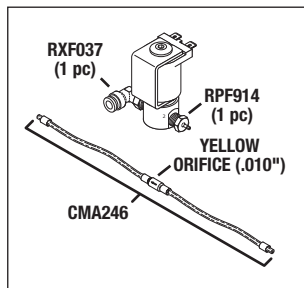

**RPI Part #CMV251**  
**OEM Part #85834**

**SOLENOID VALVE (REGENERATION SYSTEM)**

- Ports: 1/8" FPT; 2-way; N.C.
- 24/60VAC, 50Hz., 8.5W; 1/4" tabs
- Includes all parts as shown
- Also available: Solenoid Valve Repair Kit, (RPI Part #VPK006)

**Fits:** Regeneration System  
**Models:** AirStar 10D, AirStar 21D, AirStar 22D & AirStar 30D

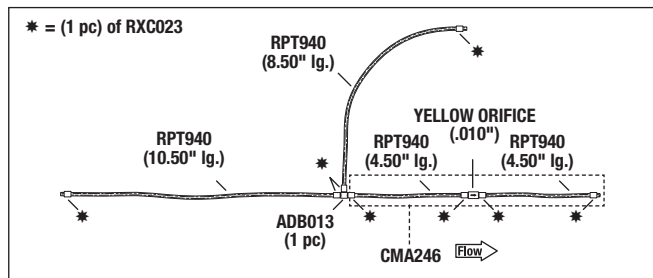
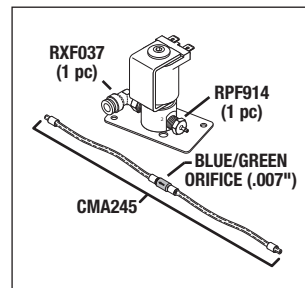

**RPI Part #CMA252**  
**OEM Part #89185**

**REGENERATION ORIFICE ASSEMBLY**

- Includes all parts as shown
- See **Also available** below

**Fits:** Purge System  
**Models:** AirStar 50D & AirStar 70D

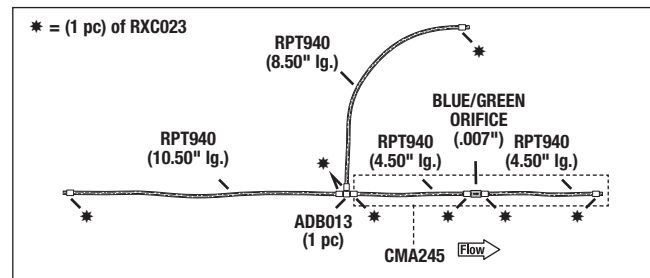

**RPI Part #CMA253**  
**OEM Part #89183**

**REGENERATION ORIFICE ASSEMBLY**

- Includes all parts as shown
- See **Also available** below

**Fits:** Purge system  
**Models:** AirStar 10D, AirStar 21D, AirStar 22D & AirStar 30D

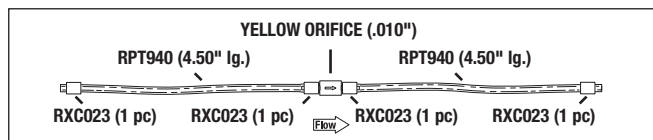

**RPI Part #CMA246**  
**OEM Part #85412**

**ORIFICE ASSEMBLY (.010")**

- Orifice .010"
- Includes all parts as shown
- See **Also available** below

**Fits:** Purge System  
**Models:** AirStar 50D & AirStar 70D

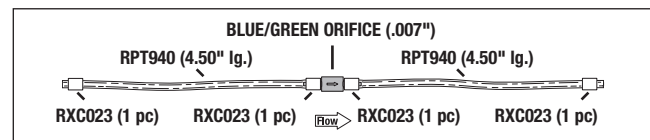

**RPI Part #CMA245**  
**OEM Part #85411**

**ORIFICE ASSEMBLY (.007")**

- Orifice .007"
- Includes all parts as shown
- See **Also available** below

**Fits:** Purge System  
**Models:** AirStar 10D, AirStar 21D, AirStar 22D & AirStar 30D



**RPI Part #RXC023**  
**OEM Part #** (No OEM Part # Available)

**SLEEVE CLAMP (1/8")**

- 20 per package
- Material: White Delrin
- See **Also available** below

**Fits:** 1/8" OD Tubing with 1/16" Barb  
**Models:** AirStar 10D, AirStar 21D, AirStar 22D, AirStar 30D, AirStar 50D & AirStar 70D

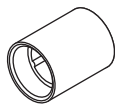

**RPI Part #ADB013**  
**OEM Part #** (No OEM Part # Available)

**BARB TEE**

- 10 per package
- 1/16" Barb Tee
- Material: Nylon®

**Fits:** 1/16" ID Tubing  
**Models:** AirStar 10D, AirStar 21D, AirStar 22D, AirStar 30D, AirStar 50D & AirStar 70D

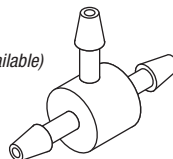

**RPI Part #RPT940**  
**OEM Part #** (No OEM Part # Available)

**TUBING (1/16" ID x 1/8" OD CLEAR)**

- Sold by the foot (reel not included)
- Material: Polyurethane

**Fits:** 1/16" Barb  
**Models:** AirStar 10D, AirStar 21D, AirStar 22D, AirStar 30D, AirStar 50D & AirStar 70D

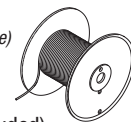

Also available: 1/8" Sleeve Tool (RPI part #RPT294) and Universal Sleeve Tool (RPI Part #RPT296)



Models: AirStar® 1, 2-1, 2-2, 3, 5, 7, 10D, 10M, 10 NEO, 12D, 12M, 21D, 21M, 21 NEO, 22D, 22M, 22 NEO, 30D, 30M, 30 NEO, 40D, 40M, 40 NEO, 50D, 50M, 50 NEO, 70D, 70M, 70 NEO & 100M

**Please Note: Model Numbers ending in "D" designate compressors with Dessicant Dryers, While Model Numbers ending in "M" designate compressors with Membrane Dryers.**

**RPI Part #VPK006**

**OEM Part #** (No OEM Part # Available)

**SOLENOID VALVE REPAIR KIT**

- Includes all parts as shown
- Also available: Solenoid Valve (Regeneration System) (RPI Part #'s CMV250 & CMV251)

**Fits:** Solenoid Valve (Regeneration System)

**Models:** AirStar 10D, AirStar 21D, AirStar 22D, AirStar 30D, AirStar 50D & AirStar 70D

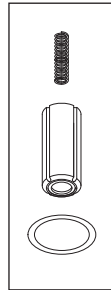

**RPI Part #RXF037**  
**OEM Part #56113**



**SWIVEL ELBOW**  
**(1/4" PUSH-IN x 1/8" MPT)**

- 2 per package
- Material: Nickel plated brass swivel fitting with plastic push-in chuck
- Included in: Solenoid Valve (Regeneration System) (RPI Part #'s CMV250 & CMV251)

**Fits:** Regeneration Assembly

**Models:** AirStar 10D, AirStar 21D, AirStar 22D, AirStar 30D, AirStar 50D & AirStar 70D

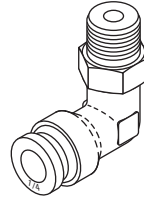

**RPI Part #RPF914**

**OEM Part #** (No OEM Part # Available)

**ADAPTOR**

**(1/16" BARB x 1/8" MPT)**

- 5 per package
- Material: Brass
- Included in: Solenoid Valve (Regeneration System) (RPI part #'S CMV250 & CMV251)

**Fits:** 1/16" ID Tubing x 1/8" FPT Ports

**Models:** AirStar 10D, AirStar 21D, AirStar 22D, AirStar 30D, AirStar 50D & AirStar 70D

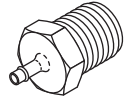

**RPI Part #VPS177**

**OEM Part #85838**

**POWER SWITCH**

- Toggle switch (On/Off)
- 20A @ 120/277VAC, SPDT
- Screw terminals
- See **Models** below for quantities required for each model

**Fits:** Electrical Control Box

**Models:** AirStar 10D, AirStar 21D and AirStar 22D requires **(1) power switch**. AirStar 30D, AirStar 30M, AirStar 40M, AirStar 50D, AirStar 50M and AirStar 100M requires **(2) power switches**. AirStar 70D and AirStar 70M requires **(3) power switches**.

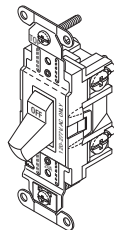

**RPI Part #CMS212**  
**OEM Part #86064**

**POWER SWITCH/  
CIRCUIT BREAKER (15A)**

- On/Off power switch
- 15A @ 250VAC
- #10-32 screw terminals

**Fits:** Electrical Control Box

**Models:** AirStar 40M, AirStar 50M & AirStar 50D (May 2006 to Current)

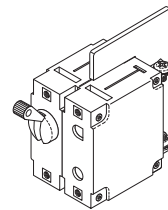

**RPI Part #CMS215**  
**OEM Part #85363**

**POWER SWITCH/  
CIRCUIT BREAKER (5A)**

- On/Off power switch
- 5A @ 250VAC
- #8-32 screw terminals

**Fits:** Electrical Control Box

**Models:** AirStar 30D (1996 to April 2004)

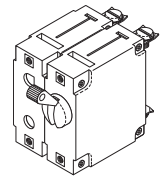

**RPI Part #CMS209**  
**OEM Part #86065 & 86063**

**POWER SWITCH/  
CIRCUIT BREAKER (10A)**

- On/Off power switch
- 10A @ 250VAC
- #10-32 screw terminals

**Fits:** Electrical Control Box

**Models:** AirStar 10M, AirStar 10D (May 2006 to Current), AirStar 30M (May 2006 to Current) & AirStar 30D (May 2004 to Current)

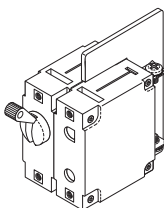

**RPI Part #CMS213**  
**OEM Part #86066**

**POWER SWITCH/  
CIRCUIT BREAKER (22A)**

- On/Off power switch
- 22A @ 250VAC
- #10-32 screw terminals

**Fits:** Electrical Control Box

**Models:** AirStar 70M (May 2006 to Current) & AirStar 70D (May 2006 to Current)

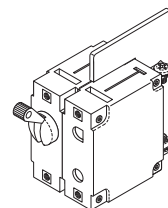

**RPI Part #VPB164**  
**OEM Part #117690**

**CIRCUIT BREAKER (1/4A)**

- 1/4A @ 250VAC
- Panel Cutout: 5/8" dia.
- Push to reset

**Fits:** Electrical Control Box

**Models:** AirStar 10D, AirStar 12M, AirStar 21D, AirStar 21M, AirStar 22D, AirStar 22M, AirStar 30D, AirStar 30M, AirStar 40M, AirStar 50D, AirStar 50M, AirStar 70D, AirStar 70M & AirStar 100M

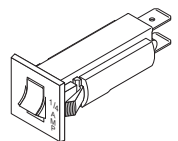

**RPI Part #CMS210**  
**OEM Part #56148**

**POWER SWITCH/  
CIRCUIT BREAKER (8A)**

- On/Off power switch
- 8A @ 250VAC
- #10-32 screw terminals

**Fits:** Electrical Control Box

**Models:** AirStar 12M, AirStar 22M, AirStar 22D, VacStar 50 & VacStar 50H

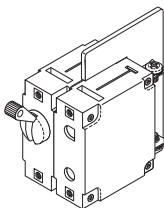

**RPI Part #CMS214**  
**OEM Part #85367**

**POWER SWITCH/  
CIRCUIT BREAKER (8A)**

- On/Off power switch
- 8A @ 250VAC
- #8-32 screw terminals

**Fits:** Electrical Control Box

**Models:** AirStar 70M (1996 to April 2006) & AirStar 70D (1996 to April 2006)

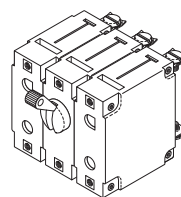

**RPI Part #VPB182**  
**OEM Part #117061**

**CIRCUIT BREAKER (1/2A)**

- 1/2 Amps @ 250VAC
- Panel Cutout: 5/8" dia.
- Push to reset

**Fits:** Electrical Control Box

**Models:** AirStar 10D, AirStar 10M, AirStar 21D, AirStar 22D, AirStar 30D, AirStar 50D & AirStar 70D

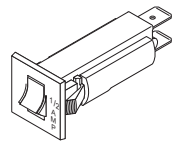

Models: AirStar® 1, 2-1, 2-2, 3, 5, 7, 10D, 10M, 10 NEO, 12D, 12M, 21D, 21M, 21 NEO, 22D, 22M, 22 NEO, 30D, 30M, 30 NEO, 40D, 40M, 40 NEO, 50D, 50M, 50 NEO, 70D, 70M, 70 NEO & 100M

**Please Note: Model Numbers ending in "D" designate compressors with Dessicant Dryers, While Model Numbers ending in "M" designate compressors with Membrane Dryers.**

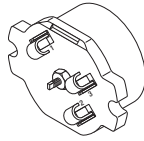

**RPI Part #CMP204**  
**OEM Part #** (No OEM Part # Available)

**THERMAL PROTECTOR ASSEMBLY**

- Automatic reset
- Opens @ 150°C ± 5°C;  
Closes @ 115°C ± 9°C
- 80A @ 120VAC; 60A @240VAC

**Fits:** Motor Terminal Box  
**Models:** AirStar 10M & AirStar 10D

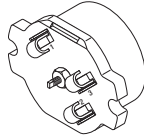

**RPI Part #CMP206**  
**OEM Part #** (No OEM Part # Available)

**THERMAL PROTECTOR ASSEMBLY**

- Automatic reset
- Opens @ 135°C ± 5°C;  
Closes @ 102°C ± 9°C
- 80A @ 120VAC; 60A @240VAC
- **Important Note:** For use on **single headed** AirStar® 40 compressors.  
(For dual headed AirStar® 40 compressors use Thermal Protector Assembly (RPI Part #CMP207))

**Fits:** Motor Terminal Box  
**Models:** AirStar 12M, AirStar 12D, AirStar 21M, AirStar 21D, AirStar 30M, AirStar 30D, AirStar 40M & AirStar 40D

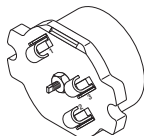

**RPI Part #CMP207**  
**OEM Part #** (No OEM Part # Available)

**THERMAL PROTECTOR ASSEMBLY**

- Automatic reset
- Opens @ 135°C ± 5°C;  
Closes @ 102°C ± 9°C
- 80A @ 120VAC; 60A @240VAC
- **Important Note:** For use on **dual headed** AirStar® 40 compressors.  
(For single headed AirStar® 40 compressors use Thermal Protector Assembly (RPI Part #CMP206))

**Fits:** Motor Terminal Box  
**Models:** AirStar 22M, AirStar 22D, AirStar 40M, AirStar 40D, AirStar 50M, AirStar 50D, AirStar 70M & AirStar 70D

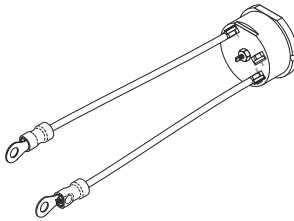

**RPI Part #CMP244**  
**OEM Part #85273**

**THERMAL PROTECTOR ASSEMBLY**

- Automatic reset
- Opens @ 90°C ± 5°C;  
Closes @ 57°C ± 9°C
- 80A @ 120VAC; 60A @240VAC
- 5" lg. wires with #10 ring terminals

**Fits:** Motor Terminal Box  
**Models:** AirStar 1, AirStar 2-1, AirStar 2-2, AirStar 3, AirStar 5 & AirStar 7

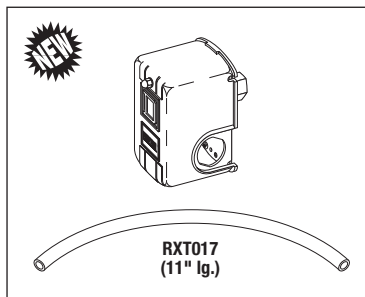

**RPI Part #CMS208**  
**OEM Part #87176 & 86436**

**PRESSURE SWITCH**

- 115/230VAC
- Contacts: N.C. DPST
- Factory set to: On at 85 PSI;  
Off at 115 PSI
- 1/4" NPSF input port
- Includes: 11" Tubing (6.5mm ID x 10mm OD Black) (RPI Part #RXT017)

**Fits:** Outlet Manifold Assembly  
**Models:** AirStar 10M, AirStar 12M, AirStar 21M, AirStar 22M, AirStar 30M, AirStar 40M, AirStar 50M, AirStar 70M and AirStar 100M

**RPI Part #CMS056**  
**OEM Part #85465**

**PRESSURE SWITCH**

- 115/230VAC
- Contacts: N.C. SPDT
- Factory set to:  
On @ 80 PSI - Off @ 100 PSI
- 1/4" FPT Input port

**Models:** AirStar 1, AirStar 2-1, AirStar 2-2, AirStar 3, AirStar 5, AirStar 7, AirStar 10D, AirStar 21D, AirStar 22D, AirStar 30D, AirStar 50D & AirStar 70D

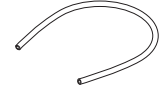
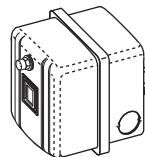

**RPI Part #CMT221**  
**OEM Part #86726**

**TUBING (10mm OD BLACK)**

- Material: Flame retardant and weld spatter resistant polyurethane (Equiv. to Flamex®)
  - Size: 20" lg.
- Fits:** Cooler Assembly to Membrane Dryer, 10mm Push-In Fittings

**Models:** AirStar 10M, AirStar 12M, AirStar 21M, AirStar 22M, AirStar 30M, AirStar 40M, AirStar 50M, AirStar 70M, AirStar 100M, AirStar 10 NEO, AirStar 21 NEO, AirStar 22 NEO, AirStar 30 NEO, AirStar 40 NEO, AirStar 50 NEO & AirStar 70 NEO



**RPI Part #CMT222**  
**OEM Part #86727**

**TUBING (12mm OD BLACK)**

- Material: Flame retardant and weld spatter resistant polyurethane (Equiv. to Flamex®)
  - Size: 28" lg.
- Fits:** Membrane Dryer to Tank, 12mm Push-In Fittings

**Models:** AirStar 10M, AirStar 12M, AirStar 21M, AirStar 22M, AirStar 30M, AirStar 40M, AirStar 50M, AirStar 70M, AirStar 100M, AirStar 10 NEO, AirStar 21 NEO, AirStar 22 NEO, AirStar 30 NEO, AirStar 40 NEO, AirStar 50 NEO & AirStar 70 NEO.

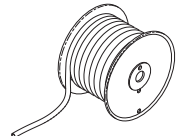

**RPI Part #RXT017**  
**OEM Part #**

(No OEM Part # Available)

**TUBING (6.5mm ID x 10mm OD BLACK)**

- Sold by the foot (reel not included)
  - Material: Flame retardant and weld spatter resistant polyurethane (Equiv. to Flamex®)
- Fits:** 10mm Push-In Fittings

**Models:** AirStar 10M, AirStar 12M, AirStar 21M, AirStar 22M, AirStar 30M, AirStar 40M, AirStar 50M, AirStar 70M, AirStar 100M, AirStar 10 NEO, AirStar 21 NEO, AirStar 22 NEO, AirStar 30 NEO, AirStar 40 NEO, AirStar 50 NEO & AirStar 70 NEO

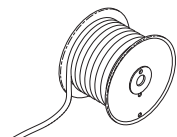

**RPI Part #RXT018**  
**OEM Part #**

(No OEM Part # Available)

**TUBING (8mm ID x 12mm OD BLACK)**

- Sold by the foot (reel not included)
  - Material: Flame retardant and weld spatter resistant polyurethane (Equiv. to Flamex®)
- Fits:** 12mm Push-In Fittings

**Models:** AirStar 10M, AirStar 12M, AirStar 21M, AirStar 22M, AirStar 30M, AirStar 40M, AirStar 50M, AirStar 70M, AirStar 100M, AirStar 10 NEO, AirStar 21 NEO, AirStar 22 NEO, AirStar 30 NEO, AirStar 40 NEO, AirStar 50 NEO & AirStar 70 NEO.





Models: AirStar® 1, 2-1, 2-2, 3, 5, 7, 10D, 10M, 10 NEO, 12D, 12M, 21D, 21M, 21 NEO, 22D, 22M, 22 NEO, 30D, 30M, 30 NEO, 40D, 40M, 40 NEO, 50D, 50M, 50 NEO, 70D, 70M, 70 NEO & 100M

Please Note: Model Numbers ending in "D" designate compressors with Dessicant Dryers, While Model Numbers ending in "M" designate compressors with Membrane Dryers.

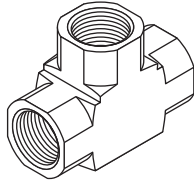

**RPI Part #RPF690**  
OEM Part # (No OEM Part # Available)

**TEE FITTING**

- Material: Brass
- Size: 1/4" FPT x 1/4" FPT x 1/4" FPT
- Included in: Check Valve Upgrade Kit (RPI Part #'s CMK247 & CMK248)

**Fits:** 1/4" FPT Ports

**Models:** AirStar 10D, AirStar 21D, AirStar 22D, AirStar 30D & AirStar 50D

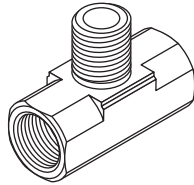

**RPI Part #RPF860**  
OEM Part # (No OEM Part # Available)

**MALE BRANCH TEE**

- Material: Brass
- Size: 1/4" MPT x 1/4" FPT x 1/4" FPT
- Included in: Check Valve Upgrade Kit (RPI Part #CMK249)

**Fits:** 1/4" FPT and MPT Ports

**Models:** AirStar 70D

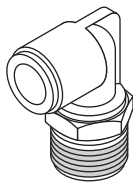

**RPI Part #RXF024**  
OEM Part #003863SP, 56133

**ELBOW (3/8" PUSH-IN x 3/8" MPT)**

- 5 per package
- Material: Brass swivel fitting with plastic push-in chuck
- Included in: Check Valve Upgrade Kit (RPI Part #'s CMK247, CMK248 & CMK249)

**Fits:** 3/8" FPT Port and 3/8" OD Tubing  
**Models:** AirStar 70D & AirStar 70M

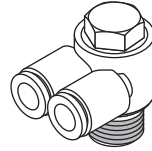

**RPI Part #RXF025**  
OEM Part #56192

**BRANCH ELBOW**

**(DUAL 1/4" PUSH-IN x 1/4" MPT)**

- Material: Brass fitting with dual plastic push-in elbow
- Included in: Check Valve Upgrade Kit (RPI Part #'s CMK247, CMK248 & CMK249)

**Fits:** 1/4" OD Tubing x 1/4" FPT Port

**Models:** AirStar 10D, AirStar 21D, AirStar 22D, AirStar 30D, AirStar 50D & AirStar 70D

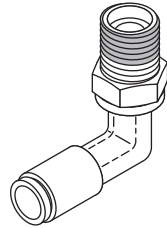

**RPI Part #RXF029**  
OEM Part #

(No OEM Part # Available)

**ELBOW FITTING**

**(1/4" PUSH-IN x 1/4" MPT)**

- 2 per package
- Material: Brass swivel elbow with plastic push-in chuck
- Included in: Check Valve Upgrade Kit (RPI Part #'s CMK247, CMK248 & CMK249)

**Fits:** 1/4" FPT Port and 1/4" OD Tubing

**Models:** AirStar 10D, AirStar 21D, AirStar 22D, AirStar 30D, AirStar 50D & AirStar 70D

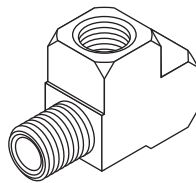

**RPI Part #RXF030**  
OEM Part # (No OEM Part # Available)

**STREET TEE (1/4" NPT)**

- Material: Brass
- Included in: Check Valve Upgrade Kit (RPI Part #'s CMK247, CMK248 & CMK249)

**Fits:** 1/4" FPT and MPT Ports

**Models:** AirStar 10D, AirStar 21D, AirStar 22D, AirStar 30D, AirStar 50D & AirStar 70D

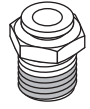

**RPI Part #RXF031**  
OEM Part # (No OEM Part # Available)

**MALE CONNECTOR**

**(1/4" PUSH-IN x 1/4" MPT)**

- 2 per package
- Material: Brass with plastic push-in chuck
- Included in: Check Valve Upgrade Kit (RPI Part #CMK248)

**Fits:** 1/4" FPT Port and 1/4" OD Tubing

**Models:** AirStar 21D, AirStar 22D, AirStar 30D & AirStar 50D

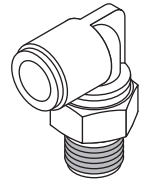

**RPI Part #RXF033**  
OEM Part #56119

**ELBOW FITTING**

**(3/8" PUSH-IN x 1/4" MPT)**

- 2 per package
- Material: Brass swivel fitting with plastic push-in chuck
- Included in: Check Valve Upgrade Kit (RPI Part #'s CMK247, CMK248 & CMK249)

**Fits:** 3/8" OD Tubing x 1/4" FPT Port

**Models:** AirStar 10D, AirStar 21D, AirStar 22D, AirStar 30D, AirStar 50D & AirStar 70D

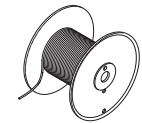

**RPI Part #RPT380**  
OEM Part #89948

**TUBING**

**(.170" ID x 1/4" OD NATURAL)**

- Sold by the foot (reel not included)
- Material: Nylon®

**Fits:** 1/4" ID Push-In Fittings

**Models:** AirStar 10D, AirStar 21D, AirStar 22D, AirStar 30D, AirStar 50D & AirStar 70D

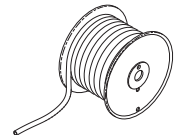

**RPI Part #RXT019**  
OEM Part #89955

**TUBING**

**(.275" ID x 3/8" OD NATURAL)**

- Sold by the foot (reel not included)
- Material: Nylon®
- Included in: Check Valve Upgrade Kit (RPI Part #'s CMK247, CMK248 & CMK249)

**Fits:** 3/8" Push-In Fittings

**Models:** AirStar 10D, AirStar 21D, AirStar 22D, AirStar 30D, AirStar 50D & AirStar 70D



**RPI Part #CMC201**  
**OEM Part #85833**

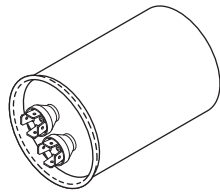

**CAPACITOR (65uF, 370VAC)**

- Run capacitor
- Size: 2.50" dia. x 3.00" lg.
- 65uF, 370VAC, 50/60Hz.

**Fits:** Electrical Control Box

**Models:** AirStar 10D, AirStar 21D, AirStar 10M & AirStar 21M

**RPI Part #CMC243**  
**OEM Part #80175**

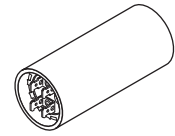

**CAPACITOR (460-552uF, 125VAC)**

- Start capacitor
- Size: 1.44" dia. x 3.33" lg.
- 460-552uF, 125VAC, 50/60Hz.

**Fits:** Electrical Control Box

**Models:** AirStar 2-1

**RPI Part #CMC202**  
**OEM Part #85832**

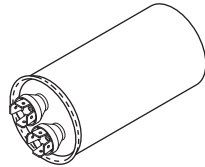

**CAPACITOR (55uF, 370VAC)**

- Run capacitor
- Size: 2.00" dia. x 3.75/4.31" lg.
- 55uF, 370VAC, 50/60Hz.

**Fits:** Electrical Control Box

**Models:** AirStar 22D, AirStar 40D, AirStar 50D, AirStar 70D,  
AirStar 22M, AirStar 40M, AirStar 50M & AirStar 70M

**RPI Part #CMC203**  
**OEM Part #85831**

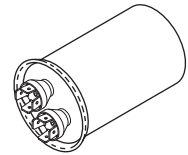

**CAPACITOR (27.5uF, 370VAC)**

- Run capacitor
- Size: 1.88" dia. x 3.00" lg.
- 27.5uF, 370VAC, 50/60Hz.
- See **Models** below for quantity required

**Fits:** Electrical Control Box

**Models:** Models AirStar 30D and AirStar 30M requires (2) capacitors



**replacement parts industries, inc.**

625 Cochran Street • Simi Valley, California • 93065

PRESORTED STANDARD  
U.S. POSTAGE PAID  
VAN NUYS, CA  
PERMIT NO. 2399

ADDRESS SERVICES REQUESTED

**New Parts to fit Air Techniques Dental Compressors!**

**RPI Part #CMR200**  
**OEM Part #89345 & 85773**

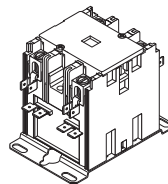

**RELAY (ELECTRICAL CONTACTOR)**

- Coil: 24VAC, 7 ohms
- 2 pole, contacts rated at 40A

**Fits:** Electrical Control Box

**Models:** AirStar 10, AirStar 21, AirStar 22,  
AirStar 30, AirStar 40, AirStar 50 & AirStar 70

**RPI Part #VPR151**  
**OEM Part #54498**

**RELAY (ELECTRICAL CONTACTOR)**

- Coil: 24VAC, 7 ohms
- 3 pole; Contacts rated at 40A

**Fits:** Electrical Control Box

**Models:** AirStar 100M

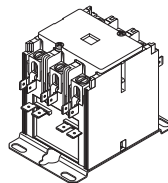

**RPI Part #VPT142**  
**OEM Part #85934,**  
**86637, 85275 & 85362**

**TRANSFORMER**

- Primary: 120/208/240VAC; 50/60Hz.
- Secondary: 24VAC @ 40A
- Includes all parts as shown

**Fits:** Electrical Control Box

**Models:** AirStar 10D, AirStar 10M, AirStar 12M, AirStar 21D,  
AirStar 21M, AirStar 22D, AirStar 22M, AirStar 30D, AirStar 30M,  
AirStar 50D, AirStar 50M, AirStar 70D, AirStar 70M & AirStar 100M

